



Cisco Vision Director Deployment Guide: Digital Media Players

Dynamic Signage Director

Release 6.3

Last Updated: 2021-02-09

First Published: 2020-10-30

THE SPECIFICATIONS AND INFORMATION REGARDING THE PRODUCTS IN THIS MANUAL ARE SUBJECT TO CHANGE WITHOUT NOTICE. ALL STATEMENTS, INFORMATION, AND RECOMMENDATIONS IN THIS MANUAL ARE BELIEVED TO BE ACCURATE BUT ARE PRESENTED WITHOUT WARRANTY OF ANY KIND, EXPRESS OR IMPLIED. USERS MUST TAKE FULL RESPONSIBILITY FOR THEIR APPLICATION OF ANY PRODUCTS.

THE SOFTWARE LICENSE AND LIMITED WARRANTY FOR THE ACCOMPANYING PRODUCT ARE INCORPORATED HEREIN BY THIS REFERENCE. IF YOU ARE UNABLE TO LOCATE THE SOFTWARE LICENSE OR LIMITED WARRANTY, CONTACT YOUR CISCO REPRESENTATIVE FOR A COPY.

The Cisco implementation of TCP header compression is an adaptation of a program developed by the University of California, Berkeley (UCB) as part of UCB's public domain version of the UNIX operating system. All rights reserved. Copyright © 1981, Regents of the University of California.

NOTWITHSTANDING ANY OTHER WARRANTY HEREIN, ALL DOCUMENT FILES AND SOFTWARE OF THESE SUPPLIERS ARE PROVIDED "AS IS" WITH ALL FAULTS. CISCO AND THE ABOVE-NAMED SUPPLIERS DISCLAIM ALL WARRANTIES, EXPRESSED OR IMPLIED, INCLUDING, WITHOUT LIMITATION, THOSE OF MERCHANTABILITY, FITNESS FOR A PARTICULAR PURPOSE AND NONINFRINGEMENT OR ARISING FROM A COURSE OF DEALING, USAGE, OR TRADE PRACTICE.

IN NO EVENT SHALL CISCO OR ITS SUPPLIERS BE LIABLE FOR ANY INDIRECT, SPECIAL, CONSEQUENTIAL, OR INCIDENTAL DAMAGES, INCLUDING, WITHOUT LIMITATION, LOST PROFITS OR LOSS OR DAMAGE TO DATA ARISING OUT OF THE USE OR INABILITY TO USE THIS MANUAL, EVEN IF CISCO OR ITS SUPPLIERS HAVE BEEN ADVISED OF THE POSSIBILITY OF SUCH DAMAGES.

Any Internet Protocol (IP) addresses and phone numbers used in this document are not intended to be actual addresses and phone numbers. Any examples, command display output, network topology diagrams, and other figures included in the document are shown for illustrative purposes only. Any use of actual IP addresses or phone numbers in illustrative content is unintentional and coincidental.

All printed copies and duplicate soft copies of this document are considered uncontrolled. See the current online version for the latest version.

Cisco has more than 200 offices worldwide. Addresses, phone numbers, and fax numbers are listed on the Cisco website at www.cisco.com/go/offices.

Cisco and the Cisco logo are trademarks or registered trademarks of Cisco and/or its affiliates in the U.S. and other countries. To view a list of Cisco trademarks, go to this URL: www.cisco.com/go/trademarks. Third-party trademarks mentioned are the property of their respective owners. The use of the word partner does not imply a partnership relationship between Cisco and any other company. (1721R)

Google, Google Play, Android and certain other marks are trademarks of Google Inc.

The terms HDMI and HDMI High-Definition Multimedia Interface, and the HDMI Logo are trademarks or registered trademarks of HDMI Licensing LLC in the United States and other countries.

© 2021 Cisco Systems, Inc. All rights reserved.



Contents

About This Guide 7

Revision History 7

Document Organization 8

Related Documentation and Resources 9

 Cisco Vision Documentation Go URL 9

 Release-Specific Documents 9

 Cisco Vision Documentation Notifications 9

 Cisco Vision Documentation Team Email Contact Information 9

 Obtaining Cisco Product Documentation 9

Getting Started with the Digital Media Players 11

Workflow Summary to Get Started 12

Operating Environment for the Digital Media Players 13

Physical Characteristics of the Digital Media Players 14

 CV-HD2 Media Player 14

 Dimensions of the CV-HD2 Media Player 15

 Ports of the CV-HD2 Media Player 15

 CV-UHD2 Media Player 17

 Dimensions of the CV-UHD2 Media Player 17

 Ports of the CV-UHD2 Media Player 17

 CV-HD Media Player 19

 Dimensions of the CV-HD Media Player 20

 Ports of the CV-HD Media Player 20

 CV-UHD Media Player 21

 Dimensions of the CV-UHD Media Player 21

 Ports on the CV-UHD Media Player 22

 DMP-2K Media Player 24

 Dimensions of the DMP-2K Media Player 24

 Ports on the DMP-2K Media Player 25

 SV-4K Media Player 26

 Dimensions of the SV-4K Media Player 26

 Ports on the SV-4K Media Player 27

Cabling Information for the Digital Media Player 28

 Other Cabling Considerations 29

 RS-232 Serial Pinout for the Series 2 DMP 30

- Mounting Guidelines for the Digital Media Players 30
 - Guidelines for Mounting the Series 2 Media Player 31
 - Guidelines for Mounting the Series 3 Media Players 31
 - Guidelines for Mounting the Series 4 Media Players 32
- LEDs on the Digital Media Players 34
 - LEDs on the Series 2 Media Players 34
 - LEDs on the Series 3 Media Players 36
 - LEDs on the Series 4 Media Players 36
- IR Remote for Cisco Vision Dynamic Signage Director 37
 - IR Remote Sensor and IR Extender 38
- Default Settings for the Digital Media Player 38
 - RS-232 Default Settings on the DMPs 38
 - Other Default Settings 39
- Feature Summary for the Digital Media Player 39
 - Cisco Vision Dynamic Signage Director Software Feature Map for the DMPs 39
 - Unsupported DMP Hardware Features 40
- Key Considerations for the Digital Media Players 41
 - Firmware Provisioning on the DMPs 41
 - Auto-Provisioning on the Digital Media Players 42
 - HDCP Support on the Digital Media Players 42
 - IR Receiver for the Digital Media Players 42
 - Storage and Memory on the Digital Media Players 42
 - Synchronization on the Digital Media Players 43
 - Switch Communication on the Digital Media Players 43
 - WiFi Network Connectivity on the CV-UHD and SV-4K DMPs 43
- Best Practices for DMP Deployment 44
 - Using Bar Code Scanners and TV Labels at Installation Time 44
 - Installer Workflow Example 44
- Planning Digital Media Player Deployment 45
 - Workflow to Plan Deployment of the Digital Media Players 45
 - Zones, Groups and Locations Planning 46
 - TV Planning for the Digital Media Player 46
 - TV Requirements for Compliance 46
 - TV Qualification for HDMI CEC Control of TV Power On/Off 46
 - Guidelines for TV **and Content Resolution** with the Digital Media Players 47
 - Restrictions for TV Display Specifications with the Digital Media Players 47
 - Configuring Resolution Display Specifications 47
 - Network and Switch Planning 49
 - External DHCP Server Requirements 49
 - DHCP Configuration Guidelines for the Digital Media Player 50
 - Connected Stadium Switch Requirements 50
 - Switch Configuration Requirements for the Digital Media Player 50

- Deploying the Digital Media Players 53
 - Prerequisites for DMP Deployment 53
 - Workflow Summary to Deploy the Digital Media Player for the First Time 53
 - Configuring the DMP Global Settings 54
 - Time Protocols and Synchronization on the Digital Media Players 54
 - Network Time Sources for the Digital Media Players 55
 - PTP Leader and Members 55
 - DMP-to-DMP Content Synchronization 55
 - Zone-Based Video Wall Synchronization 55
 - Use Cases for Video DMP-to-DMP Synchronization with PTP 55
 - How to Configure NTP and PTP on the Digital Media Players 56
 - Restrictions for PTP on the Digital Media Players 56
 - Guidelines for NTP and PTP on the Digital Media Players 57
 - Modifying the PTP and NTP Configuration on the Digital Media Players 58
 - Verifying PTP Operation for the Digital Media Player 60
- Verifying the Deployment of the Digital Media Player 61
 - Verifying the DMP Startup Sequence 61
 - Startup Sequence Flow for the Digital Media Player 61
- Monitoring and Maintaining the Digital Media Player 65
 - Performing a Regular Reboot of the Digital Media Players 65
 - Verifying Digital Media Player Compliance 65
 - Clearing the Storage on the Digital Media Player 66
 - Clearing Registries on the Digital Media Player by Restoring Factory Defaults 68
- Troubleshooting the Digital Media Player 69
 - Before You Begin Troubleshooting the DMPs 69
 - RMA Process for the DMPs 69
 - DMP Diagnostic URL 69
 - Troubleshooting PTP Operation for the Digital Media Player 70
 - Symptom: Local PNGs are not synchronized across DMP devices 70
 - Symptom: Playlists do not advance to the next content item on the DMP 70
 - Troubleshooting DMP Hardware Operation 71
 - Symptom: “Please Insert Card” message on SV-4K or DMP-2K startup screen 72
 - Symptom: Pwr and Eth LEDs are not lit and no signs of activity on the DMP 72
 - Symptom: DMP Err or Err/Upd LEDs blinking 72
 - Symptom: DMP rebooting automatically after startup 72
 - Symptom: DMP lose storage after startup power loss 73
 - Troubleshooting DMP TV and Video Display Problems 73
 - Symptom: Black screen on the TV display/no multicast video stream 73

Symptom: No local control when external volume strategy configured 74

Appendix A: DMP and TV Controls Commands for the Digital Media Players 75

Monitoring Commands for the Digital Media Player 75

DMP Commands for the Digital Media Player 76

DMP Install Commands for the Digital Media Player 76

TV Commands for the Digital Media Player 76

Auto-Registration Commands for the Digital Media Player 77

Appendix B: Display Parameters for the Digital Media Players 79

Display Parameters for HDMI CEC TV Control on DMPs 79

Display Parameter for Portrait Mode Content Renditions on DMPs 80

Display Parameters for RS-232 TV Control on DMPs 81

Appendix C: Configuring an IOS DHCP Server to Support the Digital Media Players 83

SV-4K DHCP Scope Example 83

Creating Option 60 83

Creating Option 43 84

Option 43 Example 84



About This Guide

This guide is for installers and administrators of Cisco Vision venues who are responsible for both the physical installation and initial configuration of the digital media players (DMPs) with TV displays.

Note:

Series 2 = DMP-2K and SV-4K players

Series 3 = CV-HD and CV-UHD players

Series 4 = CV-HD2 and CV-UHD2 players

In the documentation for Cisco Vision Dynamic Signage Director, we changed the terms “master” to “lead, leader, or primary,” the term “slave” to “secondary,” the term “whitelist” to “allowlist,” and the term “blacklist” to “blocklist.” There are currently no changes to the product’s syntax, so these terms are still present in the documentation where the current code requires their use. Where an industry standard exists, such as IEEE terminology, we cannot alter the term until the standards change.

Revision History

Table 1 on page 7 provides information about when this document was changed.

Table 1 Revision History Table

Date	Description
2021-02-09	Update to include clear information about changing the DMP password. See DMP Diagnostic URL, page 69 .
2020-10-30	Initial publication for Cisco Vision Dynamic Signage Director Release 6.3.

Document Organization

This guide includes the following modules:

Chapter	Description
Getting Started with the Digital Media Players, page 11	<p>This module provides a workflow summary with information about the DMP hardware, software features, and key considerations before deploying these media players.</p> <p>It is intended for anyone who is responsible for installing and configuring the digital media players, and for anyone interested in understanding its general operation.</p>
Planning Digital Media Player Deployment, page 45	<p>This module describes aspects of the DMP deployment that need to be considered and executed prior to the actual installation and provisioning of the digital media players.</p> <p>It is intended for installers, network administrators, and administrators of Cisco Vision Dynamic Signage Director.</p>
Deploying the Digital Media Players, page 53	<p>This module describes the workflow and tasks to deploy the digital media player.</p> <p>It is intended for Cisco Vision Dynamic Signage Director administrators and installers.</p>
Verifying the Deployment of the Digital Media Player, page 61	<p>This module includes information about the startup sequence when deploying a digital media player.</p>
Monitoring and Maintaining the Digital Media Player, page 65	<p>This module describes the workflow and tasks to monitor and maintain the working operation of the digital media player.</p> <p>It is intended for Cisco Vision Dynamic Signage Director administrators and installers.</p>
Troubleshooting the Digital Media Player, page 69	<p>This module provides some troubleshooting steps by symptoms for DMP hardware, PTP operation, and video display problems. It includes information about the RMA process and the DMP diagnostic URL.</p>
Appendix A: DMP and TV Controls Commands for the Digital Media Players, page 75	<p>This module provides a summary of the commands that are supported by the digital media players and TVs.</p>
Appendix B: Display Parameters for the Digital Media Players, page 79	<p>This module provides a summary of the display parameters that are supported by the digital media player for communication with TV displays.</p>
Appendix C: Configuring an IOS DHCP Server to Support the Digital Media Players, page 83	<p>This module provides an example of how to configure a Cisco IOS DHCP server with a single DHCP scope and configuring Option 60 and Option 43.</p>

Related Documentation and Resources

Cisco Vision Documentation Go URL

For more information about Cisco Vision hardware and software installation, configuration, and operation, see the Cisco Vision documentation available on Cisco.com at:

www.cisco.com/go/stadiumvisiondocs

Release-Specific Documents

- [Release Notes for Cisco Vision Dynamic Signage Director Release 6.2 or 6.3](#)
- For the listing page of all Cisco Vision documentation, go to:

<http://www.cisco.com/c/en/us/support/video/stadiumvision/tsd-products-support-series-home.html>

Cisco Vision Documentation Notifications

You can receive periodic emails that summarize new and changed information in Cisco Vision documentation by subscribing to the `sv-doc-notify@external.cisco.com` email alias.

Contact us at `stadiumvisiondocs@external.cisco.com` to request this notification service.

Cisco Vision Documentation Team Email Contact Information

You can submit questions, suggestions, or other feedback to us at `stadiumvisiondocs@external.cisco.com`.

Obtaining Cisco Product Documentation

For information on obtaining other Cisco Product documentation, see the monthly What's New in Cisco Product Documentation, which also lists all new and revised Cisco technical documentation, at:

<http://www.cisco.com/en/US/docs/general/whatsnew/whatsnew.html>

Subscribe to the What's New in Cisco Product Documentation as an RSS feed and set content to be delivered directly to your desktop using a reader application. The RSS feeds are a free service. Cisco currently supports RSS Version 2.0.



Getting Started with the Digital Media Players

Series 2 DMPs: DMP-2K and SV-4K

Series 3 DMPs: CV-HD and CV-UHD

Series 4 DMPs: CV-HD2 and CV-UHD2

Note: Cisco announced an [End Of Sale](#) and support for the Series 2 DMPs, November 30, 2018.

This module provides a workflow summary with information about the Series 2, Series 3, and Series 4 hardware, software features, and key considerations before deploying these digital media players.

It is intended for anyone who is responsible for installing and configuring the digital media player and for anyone interested in understanding its general operation.

It includes the following topics:

- [Workflow Summary to Get Started, page 12](#)
- [Operating Environment for the Digital Media Players, page 13](#)
- [Physical Characteristics of the Digital Media Players, page 14](#)
- [IR Remote for Cisco Vision Dynamic Signage Director, page 37](#)
- [Default Settings for the Digital Media Player, page 38](#)
- [Feature Summary for the Digital Media Player, page 39](#)
- [Key Considerations for the Digital Media Players, page 41](#)
- [Best Practices for DMP Deployment, page 44](#)

Workflow Summary to Get Started

Table 1 on page 12 provides a summary of the tasks and related information to get familiar with the digital media player.

Table 1 Getting Started Task Summary

Getting Started Task	For more information see:
Understand the CV-HD2 hardware	<ul style="list-style-type: none"> ■ Operating Environment for the Digital Media Players, page 13 ■ Dimensions of the CV-HD2 Media Player, page 15 ■ Ports of the CV-HD2 Media Player, page 15 ■ Cabling Information for the Digital Media Player, page 28 ■ Mounting Guidelines for the Digital Media Players, page 30 ■ LEDs on the Series 4 Media Players, page 36 ■ Default Settings for the Digital Media Player, page 38
Understand the CV-UHD2 hardware	<ul style="list-style-type: none"> ■ Operating Environment for the Digital Media Players, page 13 ■ Dimensions of the CV-UHD2 Media Player, page 17 ■ Ports of the CV-UHD2 Media Player, page 17 ■ Cabling Information for the Digital Media Player, page 28 ■ Mounting Guidelines for the Digital Media Players, page 30 ■ LEDs on the Series 4 Media Players, page 36 ■ Default Settings for the Digital Media Player, page 38
Understand the CV-HD hardware	<ul style="list-style-type: none"> ■ Operating Environment for the Digital Media Players, page 13 ■ Dimensions of the CV-HD Media Player, page 20 ■ Ports of the CV-HD Media Player, page 20 ■ Cabling Information for the Digital Media Player, page 28 ■ Mounting Guidelines for the Digital Media Players, page 30 ■ LEDs on the Series 3 Media Players, page 36 ■ Default Settings for the Digital Media Player, page 38
Understand the CV-UHD hardware	<ul style="list-style-type: none"> ■ Operating Environment for the Digital Media Players, page 13 ■ Dimensions of the CV-UHD Media Player, page 21 ■ Ports on the CV-UHD Media Player, page 22 ■ Cabling Information for the Digital Media Player, page 28 ■ Mounting Guidelines for the Digital Media Players, page 30 ■ LEDs on the Series 3 Media Players, page 36 ■ Default Settings for the Digital Media Player, page 38

Table 1 Getting Started Task Summary (continued)

Getting Started Task	For more information see:
Understand the DMP-2K hardware	<ul style="list-style-type: none"> ■ Operating Environment for the Digital Media Players, page 13 ■ Dimensions of the DMP-2K Media Player, page 24 ■ Ports on the DMP-2K Media Player, page 25. ■ Cabling Information for the Digital Media Player, page 28 ■ Mounting Guidelines for the Digital Media Players, page 30 ■ LEDs on the Series 2 Media Players, page 34 ■ Default Settings for the Digital Media Player, page 38
Understand the SV-4K hardware	<ul style="list-style-type: none"> ■ Operating Environment for the Digital Media Players, page 13 ■ Dimensions of the SV-4K Media Player, page 26 ■ Ports on the SV-4K Media Player, page 27. ■ Cabling Information for the Digital Media Player, page 28 ■ Mounting Guidelines for the Digital Media Players, page 30 ■ LEDs on the Series 2 Media Players, page 34 ■ Default Settings for the Digital Media Player, page 38
Understand the Series 2, Series 3, and Series 4 features	<ul style="list-style-type: none"> ■ Cisco Vision Dynamic Signage Director Software Feature Map for the DMPs, page 39. ■ Unsupported DMP Hardware Features, page 40.
Understand the Differences Between the Players	Key Considerations for the Digital Media Players, page 41
Review deployment best practices	Best Practices for DMP Deployment, page 44
Perform pre-deployment site planning and configuration	Planning Digital Media Player Deployment, page 45

Operating Environment for the Digital Media Players

[Table 2 on page 13](#) describes the supported environment for proper operation of the Series 2, Series 3, and Series 4 media players.

Table 2 Supported Operating Environment for the Series 2, Series 3, and Series 4 DMPs

Operating Environment	Supported Conditions
Temperature	0° C to 70° C
Humidity	Up to 90% maximum relative humidity, non-condensing

Caution: Do not allow condensation of any vapor to touch the DMPs at any time. Do not spill food or drinks of any kind on the DMPs. Before powering up the DMP, let it come to room temperature to remove any possibility of condensation build up inside the device.

Physical Characteristics of the Digital Media Players

This section provides information about the dimensions and ports on each of the Series 2, Series 3, and Series 4 media players:

- [CV-HD2 Media Player, page 14](#)
- [CV-UHD2 Media Player, page 17](#)
- [CV-HD Media Player, page 19](#)
- [CV-UHD Media Player, page 21](#)
- [DMP-2K Media Player, page 24](#)
- [SV-4K Media Player, page 26](#)
- [Cabling Information for the Digital Media Player, page 28](#)
- [Mounting Guidelines for the Digital Media Players, page 30](#)
- [LEDs on the Digital Media Players, page 34](#)

Note: Refer to the DMP-specific Datasheet for additional specification information. See Datasheets for [Cisco Vision Digital Media Players](#).

CV-HD2 Media Player



Dimensions of the CV-HD2 Media Player

Figure 1 CV-HD2 Dimensions

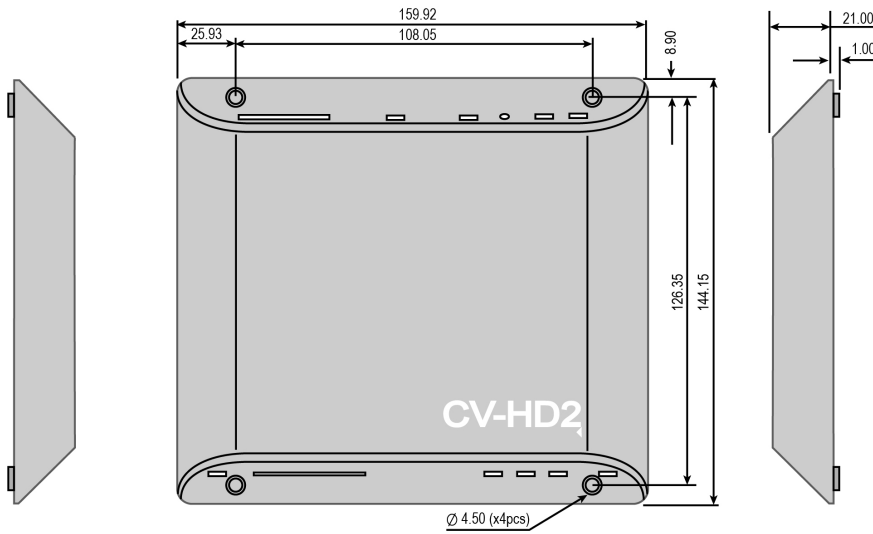

Ports of the CV-HD2 Media Player

Figure 2 CV-HD2 Front Ports



Table 3 CV-HD2 Front Ports Descriptions

Name/Description	Usage
PoE Ethernet RJ-45 1000 Base-T Ethernet port	Connect to switch network for PoE+ dynamic negotiation of 15W or 30W.
microSD Slot	SDHC storage up to 32 GB; SDXC storage up to 2 TB
HDMI	HDMI In HDMI input connector (compatible with HDMI 2.0 devices) to receive digital audio/video content from an HDMI-enabled source. The signaling conforms with DVI 1.0, HDMI 1.4, and HDCP 2.2 standards.
USB	USB 2.0 High-Speed Port (Type A)

Table 3 CV-HD2 Front Ports Descriptions

Name/Description	Usage
SVC	This is used for service only.
Reset	The Reset button is connected to the reset circuit. Pressing down the Reset button will send an initial signal to the system software, and holding the reset button low for approximately 4 seconds will cause a hard reset.
12V 1.5A	PoE 15W

- If power is negotiated to 15W, services on the CV-HD2 are restricted. This includes shut down of the HDMI-In port and unavailability of one CPU. If using USB for touch screen support, the USB port power is sufficiently reduced to impact support of any high-power devices.
- Warning:** Do not supply power to network port using AC power cable. When using PoE, budget appropriate power for optimal DMP operation.

Figure 3 CV-HD2 Rear Ports**Table 4 CV-HD2 Rear Port Descriptions**

Name/Description	Usage
Audio	3.5 mm audio out (digital and analog)
IR	3.5mm IR in/out
Serial	GPIO (12 pins)
Pwr	Displays when the board is powered up and not in reset mode. Flashes during the firmware update process.
Bsy-Green file-system activity	Flashes any time there is file-system activity (on any storage device)
WiFi	Flashes when the player is connecting to the wireless network. Displays when connected.
Err	Flashes a certain number of times to indicate which error is occurring. For ERR codes, see Table 22 on page 37 .

CV-UHD2 Media Player



Dimensions of the CV-UHD2 Media Player

Figure 4 CV-UHD2 Dimensions

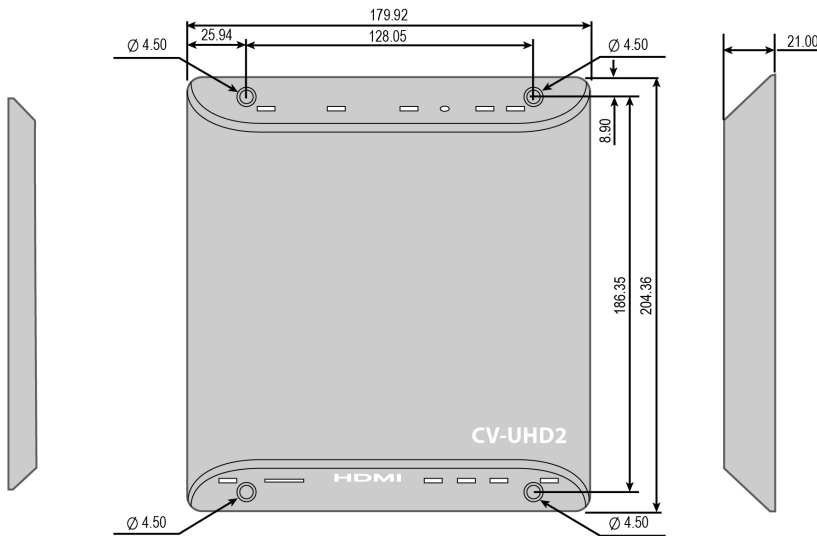

Ports of the CV-UHD2 Media Player

Figure 5 CV-UHD2 Front Ports



Table 5 CV-UHD2 Front Port Descriptions

Name/Description	Usage
microSD	Not used/supported.
Pwr (green) LED	Displays when the board is powered up and not in reset mode. Flashes during the firmware update process.
BSy (green) LED	Flashes any time there is file-system activity (on any storage device)
WiFi (blue) LED	Flashes when the player is connecting to the wireless network. Displays when connected.
Err (red) LED	Flashes a certain number of times to indicate which error is occurring. See Table 22 on page 37 for flash codes described.
HDMI Out	HDMI Out High-Definition Multimedia Interface (HDMI) output connector (compatible with HDMI 2.0 devices) to transmit digital audio/video content.
HDMI In	HDMI In HDMI input connector (compatible with HDMI 2.0 devices) to receive digital audio/video content from an HDMI-enabled source. The signaling conforms with DVI 1.0, HDMI 1.4, and HDCP 2.2 standards.
USB 2.0 (Type C)	1A Power for small human interface devices (HIDs).
SVC	The Service (SVC) button provides a dedicated GPIO button (GPIO12) for the OS. Pressing the SVC button pulls the pin low. Conversely, releasing the button pulls the pin high.
Reset	The Reset button is connected to the reset circuit. Pressing down the Reset button will send an initial signal to the system software, and holding the reset button low for approximately 4 seconds will cause a hard reset.
PoE Ethernet ¹ RJ-45 1000 Base-T Ethernet port ²	Connect to switch network for PoE+ 30W negotiated power reservation. 15W to boot.

1. If power is negotiated to 15W, services on the CV-UHD2 are restricted. This includes shut down of the HDMI-In port and unavailability of one CPU. If using USB for touch screen support, the USB port power is sufficiently reduced to impact support of any high-power devices. When only 15W is available, the USB ports will retain I/O functionality but limit power output to 100mA / port. Additionally HDMI-In is not supported and graphics performance will be reduced.
2. **Warning:** Do not supply power to network port using AC power cable. When using PoE, budget appropriate power for optimal DMP operation.

Note: WiFi is not supported for this DMP.

Figure 6 CV-UHD2 Rear Ports



Table 6 CV-UHD2 Rear Port Descriptions

Name/Description	Usage
Audio	3.5mm audio out (optical digital and analog).
USB 2.0 (Type A)	1.5A Power for small human interface devices (HIDs).
IR	3.5mm IR in/out.
Serial	3.5 mm RS-232 Serial Port.
GPIO 3.3V	GPIO (12 pins). Note: Not supported in Release 6.3.
Power Connector 36W (12V@3A)	Note: Not for production use in Cisco Vision Dynamic Signage Director. The CV-UHD2 is qualified for Cisco Vision Dynamic Signage Director using Power over Ethernet (PoE+) via the Ethernet port.

Warning: Do not supply power to network port using AC power cable. When using PoE, budget appropriate power (30 W) for optimal DMP operation and use LLDP.

CV-HD Media Player

Figure 7 CV-HD Dimensions



Dimensions of the CV-HD Media Player

Figure 8 CV-HD Dimensions

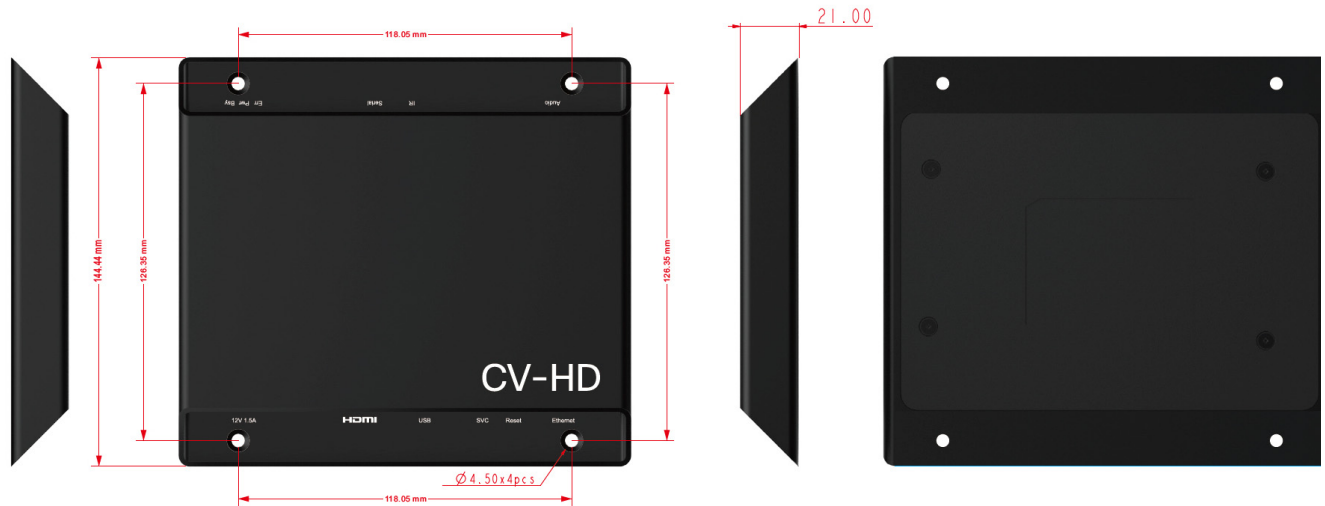

Ports of the CV-HD Media Player

Figure 9 Front Ports of CV-HD Media Player



Table 7 CV-HD Front Port Descriptions

Name/Description	Usage
12V 1.5 A	Power to the DMP
HDMI	Connect to HDCP-compliant laptop or other device
USB	USB 2.0 (Type A)
SVC	GPIO (12 pins)
Reset	The Reset button is connected to the reset circuit. Pressing down the Reset button will send an initial signal to the system software, and holding the reset button low for approximately 4 seconds will cause a hard reset.
PoE Ethernet	RJ45 LAN, WiFi antenna connector (2 of 2)

Figure 10 Rear Ports of CV-HD Media Player



Table 8 CV-HD Rear Port Descriptions

Name/Description	Usage
Audio	3.5mm audio out.
IR	3.5mm IR in/out.
Serial	Connect to TV serial port for control of the TV via RS-232 commands.
Err LED	Flashes a certain number of times to indicate which error is occurring. See Table 21 on page 36 for flash codes described.
Pwr	(green)–Displays when the device is powered on and not in reset mode.
Bsy	(green)–Flashes when there is file-system activity.

CV-UHD Media Player

Dimensions of the CV-UHD Media Player

Figure 11 CV-UHD Dimensions



Ports on the CV-UHD Media Player

Figure 12 CV-UHD Front Panel



Table 9 CV-UHD Front Port Descriptions

Number	Name/Description	Usage
1	LED bank See LEDs on the Series 3 Media Players, page 36 .	Observe for operational status.
2	MicroSD	Not supported
3	HDMI Out High-Definition Multimedia Interface (HDMI) output connector (compatible with HDMI 2.0 devices) to transmit digital audio/video content.	Connect to HDMI In port on the TV.
4	HDMI In HDMI input connector (compatible with HDMI 2.0 devices) to receive digital audio/video content from an HDMI-enabled source. The signaling conforms with DVI 1.0, HDMI 1.4, and HDCP 2.2 standards.	Connect to HDCP-compliant laptop or other device.
5	USB–2.0 Type A	Type C only for touchscreen.
6	SVC	This is used for service only.
7	Reset	The Reset button is connected to the reset circuit. Pressing down the Reset button will send an initial signal to the system software, and holding the reset button low for approximately 4 seconds will cause a hard reset.
8	PoE Ethernet 12V / 3A (PoE+ 30W) ¹ RJ-45 1000 Base-T Ethernet port ²	Connect to switch network for PoE+ dynamic negotiation of 15W or 30W.

Physical Characteristics of the Digital Media Players

1. If power is negotiated to 15W, services on the CV-UHD are restricted. When only 15W is negotiated via PoE, the DMP will continue to operate, but the graphics clock speed and processing performance is reduced, the USB ports will limit power output to 100 mA per port, and the HDMI-In is disabled.
2. **Warning:** Do not supply power to network port using AC power cable. When using PoE, budget appropriate power for optimal DMP operation.

Figure 13 CV-UHD Rear Ports

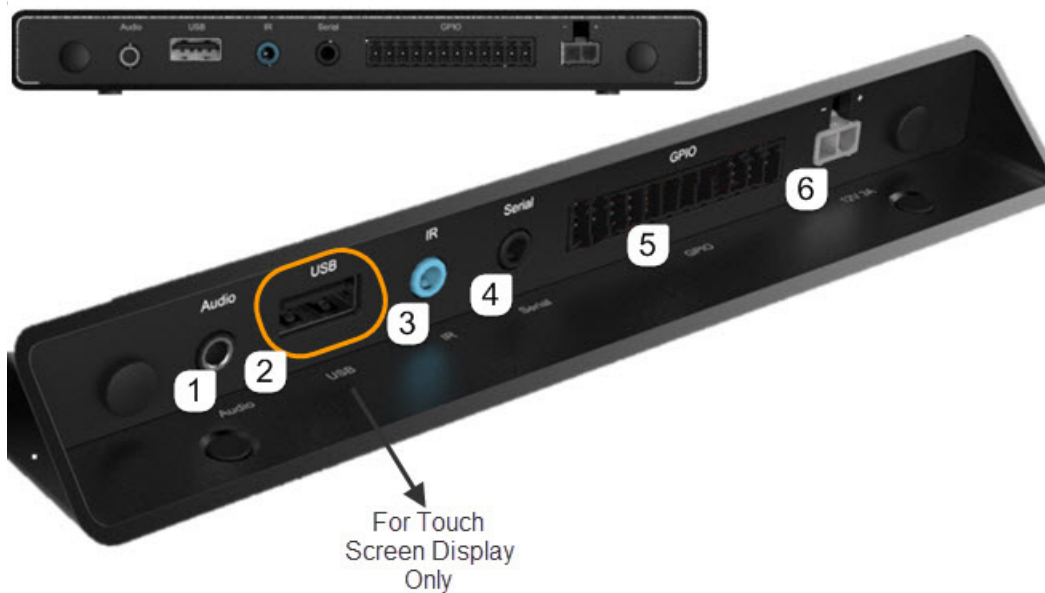

Table 10 CV-UHD Rear Port Descriptions

Number	Name/Description	Usage
1	Audio ¹ 3.5 mm female audio connector for analog stereo signal.	Required only for connections that do not support audio, such as HDMI-to-DVI connections from device to the TV. Also supports a “Mini Toslink” connector which outputs digital audio. 3.5 mm audio out (optical digital and analog).
2	USB USB 2.0 Type C port.	Intended for touch screen display use only with Cisco Vision Dynamic Signage Director.
3	IR 3.5 mm infrared in/out.	Series 3 media players do not have an internal infrared receiver. Use the included IR extender cable to support an IR remote.

Table 10 CV-UHD Rear Port Descriptions

Number	Name/Description	Usage
4	Serial (TTL) ² 3.5 mm universally asynchronous receiver/transmitter (UART) (asynchronous serial) interface (1/8" jack) that uses transistor-transistor logic (TTL).	Connect to TV serial port for control of the TV via RS-232 commands.
5	GPIO General Purpose Input/Output.	Not supported.
6	Power connector Rated 12V 3A.	The CV-UHD is qualified for Cisco Vision Dynamic Signage Director using Power over Ethernet (PoE+) via the Ethernet port ³ .

1. The analog audio out port is designed to drive line-level impedances in the higher Ohm range, such as for commercial grade speaker systems. Headphones are typically just a few Ohms and not recommended for use with this port.
2. The DMP serial interface transmits on pin 1 (Tip), receives on pin 2 (Ring), and sleeve is ground.
3. Not for production use in Cisco Vision Dynamic Signage Director. **Warning:** Do not supply power to network port using AC power cable. When using PoE, budget appropriate power (30 W) for optimal DMP operation and use LLDP.

DMP-2K Media Player

Dimensions of the DMP-2K Media Player

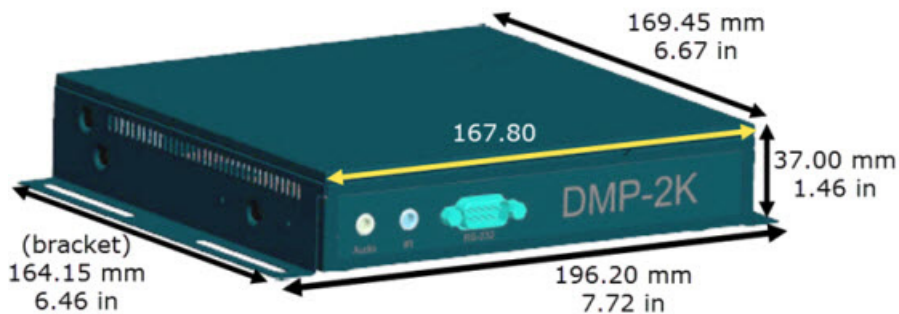
Figure 14 DMP-2K Dimensions

Ports on the DMP-2K Media Player

Figure 15 DMP-2K Front Panel



Table 11 DMP-2K Front Panel Port Descriptions

Port Name	Usage	Description
Audio ¹	Required only for connections that do not support audio, such as HDMI-to-DVI connections from device to the TV.	3.5 mm female audio connector for analog stereo signal.
IR	The DMP-2K does not have an internal infrared receiver. You must use the included IR extender cable to support an IR remote.	3.5 mm infrared in/out.
RS-232	Connect to TV serial port for control of the TV via RS-232 commands.	RS-232 serial interface with male DE-9 connector. This connection is used for TV control.

1. The analog audio out port is designed to drive line-level impedances in the higher Ohm range, such as for commercial grade speaker systems. Headphones are typically just a few Ohms and not recommended for use with this port.

Figure 16 DMP-2K Rear Panel

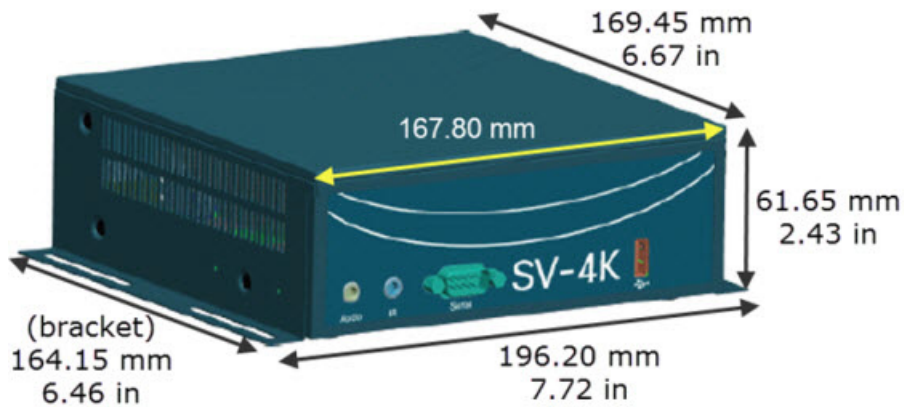

Table 12 DMP-2K Rear Panel Port Descriptions

Port Name	Usage	Description
12V 5A	Not for production use in Cisco Vision Dynamic Signage Director. Note: The DMP-2K is qualified for Cisco Vision Dynamic Signage Director using Power over Ethernet (PoE+) via the Ethernet port.	60-watt/12-volt/5-amp power supply.
SPDIF	Provides audio from the primary video routed by Cisco Vision Dynamic Signage Director to the SPDIF port.	Sony/Phillips Digital Interface.
HDMI	Connect to HDMI In port on the TV.	High-Definition Multimedia Interface (HDMI) output connector to transmit digital audio/video content.
USB 3.0	Not supported.	Single USB 3.0 port (backward-compatible).
Ethernet	Connect to switch network for PoE+.	RJ-45 10/100/1000 Base-T Ethernet port.

SV-4K Media Player

Dimensions of the SV-4K Media Player

Figure 17 SV-4K Dimensions

Ports on the SV-4K Media Player

Figure 18 SV-4K Front Panel



Table 13 SV-4K Front Panel Port Descriptions

Port Name	Usage	Description
Audio ¹	Required only for connections that do not support audio, such as HDMI-to-DVI connections from device to the TV.	3.5 mm female audio connector for analog stereo signal.
IR	The SV-4K does not have an internal infrared receiver. You must use the included IR extender cable to support an IR remote.	3.5 mm infrared in/out.
Serial	Connect to TV serial port for control of the TV via RS-232 commands.	RS-232 serial interface with male DE-9 connector. This connection is used for TV control.
USB	Not supported.	USB 2.0 port.

1. The analog audio out port is designed to drive line-level impedances in the higher Ohm range, such as for commercial grade speaker systems. Headphones are typically just a few Ohms and not recommended for use with this port.

Figure 19 SV-4K Rear Panel

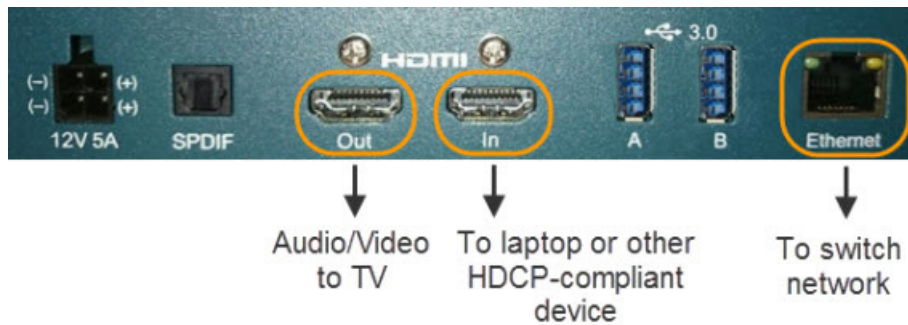

Table 14 SV-4K Rear Panel Port Descriptions

Port Name	Usage	Description
12V 5A	Required when running the SV-4K over a WiFi connection. Note: The SV-4K must first be provisioned over PoE+ with configuration of WiFi completed in Cisco Vision Dynamic Signage Director. See How to Deploy WiFi Network Connectivity on the SV-4K .	60-watt/12-volt/5-amp power supply.
SPDIF	Provides audio from the primary video routed by Cisco Vision Dynamic Signage Director to the SPDIF port.	Sony/Phillips Digital Interface.
HDMI Out	Connect to HDMI In port on the TV.	High-Definition Multimedia Interface (HDMI) output connector to transmit digital audio/video content.
HDMI In	Connect to HDCP-compliant laptop or other device.	HDMI input connector to receive digital audio/video content from an HDMI-enabled source.
USB 3.0 A USB 3.0 B	USB ports work, but not supported at 3.0.	Two USB 3.0 ports (backward-compatible).
Ethernet	Connect to switch network for PoE+.	RJ-45 10/100/1000 Base-T Ethernet port.

Warning: Do not supply power to network port using AC power cable. When using PoE, budget appropriate power (30 W) for optimal DMP operation and use LLDP.

Cabling Information for the Digital Media Player

Table 15 on page 28 describes the cables that ship with the DMP-2K and SV-4K hardware.

Table 15 Cables Shipped with Series 2 Hardware

Cable	Length	Purpose
Female-to-Female Serial Adapter	2 M	(As required) For serial device connections.

Physical Characteristics of the Digital Media Players

Table 15 Cables Shipped with Series 2 Hardware (continued)

Cable	Length	Purpose
HDMI-to-HDMI	2 M	(Required) Connects the HDMI Out (male) to the HDMI In (male) port on the TV for digital audio and video support. Compliant with HDMI version 1.4.
RS-232 DE-9 DCE/DTE Straight Through	2 M	(Required for TV control over RS-232) Connects the DMP serial DTE (male) port to a serial DCE (female) port on the TV.
IR Extender	2 M	(Required for IR Remote) Connects to the IR port on the DMP front panel to serve as an infrared signal receiver for the device.

Table 16 on page 29 describes the cables that ship with the CV-HD and CV-UHD hardware.

Table 16 Cables Shipped with Series 3 Hardware

Cable	Length	Purpose
Female-to-Female Serial Adapter	2 M	(As required) For serial device connections.
HDMI-to-HDMI	2 M	(Required) Connects the HDMI Out (male) to the HDMI In (male) port on the TV for digital audio and video support. Compliant with HDMI version 1.4.
3.5 mm to male DB-9 Serial Adapter	2 M	(Required for TV control over RS-232) Connects the DMP 3.5 mm serial port to a serial DCE (female) port on the TV.
IR Extender	2 M	(Required for IR Remote) Connects to the IR port on the DMP front panel to serve as an infrared signal receiver for the device.

Table 17 on page 29 describes the cables that ship with the CV-HD2 and CV-UHD2 hardware.

Table 17 Cables shipped with Series 4 Hardware

Cable	Length	Purpose
Female-to-Female Serial Adapter	2 M	(As required) For serial device connections.
HDMI-to-HDMI	2 M	(Required) Connects the HDMI Out (male) to the HDMI In (male) port on the TV for digital audio and video support. Compliant with HDMI version 1.4.
3.5 mm to male DB-9 Serial Adapter	2 M	(Required for TV control over RS-232) Connects the DMP 3.5 mm serial port to a serial DCE (female) port on the TV.
IR Extender	2 M	(Required for IR Remote) Connects to the IR port on the DMP front panel to serve as an infrared signal receiver for the device.

Other Cabling Considerations

Assess the ports available on the TVs at the venue so that you can get any additional adapters or cable types that are needed to connect the Series 2, Series 3, and Series 4 DMPs to the TVs. RX and TX pins vary for each TV manufacturer and a null modem adapter may be required. We do not recommend using RS232 splitters to control multiple TVs. Best practice is a 1:1 DMP to TV mapping. For HDMI, no splitters are qualified.

Physical Characteristics of the Digital Media Players

Ethernet Cable

Use standard Category 5e or 6 cables no longer than 100 meters in length.

Null Modem (Crossover) Cable

The Series 2 DMPs are a DTE serial device. Therefore, if the TV also has a DTE (male) serial port, use a null modem (crossover) cable for the TV control connection.

HDMI-to-DVI Adapter

If the TV does not support HDMI In, then you cannot use the standard HDMI-to-HDMI cable that ships with the DMPs. However, if the TV supports a DVI-D connection, then you can acquire a DVI adapter for the HDMI cable to make the HDMI-to-DVI connection.

Since this type of connection only supports video, you will also need to connect the DMP audio port to the audio input ports on the TV if audio support is required.

Other HDMI Cable Adapters

The HDMI cable that ships with the digital media player is compliant with HDMI version 1.4. If you are using any other cable adapters, be sure that they support HDMI version 1.4 if you plan to support UHD video content.

Audio Cables

Audio cables are not generally needed. However, there are a couple of cases where you might need to make an audio connection to the SV-4K:

- If you need to support an HDMI-to-DVI connection from the SV-4K to the TV since this supports video only.
- If you need to connect to external audio distribution equipment when audio is to be distributed within an area.

RS-232 Serial Pinout for the Series 2 DMP

[Table 18 on page 30](#) provides the pin out for the DE-9 serial connector on the front panel of the Series 2 DMPs.

Table 18 Series 2, Series 3, and Series 4 Serial DE-9 Pinout

Pin	Description	Pin	Description
1	NC	2	Receive data into the device
3	Transmit data out of the device	4	Available 5V@500mA
5	Ground	6	NC
7	RTS	8	CTS
9	NC		

Mounting Guidelines for the Digital Media Players

- [Guidelines for Mounting the Series 2 Media Player, page 31](#)
- [Guidelines for Mounting the Series 3 Media Players, page 31](#)
- [Guidelines for Mounting the Series 4 Media Players, page 32](#)

Guidelines for Mounting the Series 2 Media Player

Consider the following guidelines before mounting the Series 2 media player:

- Do not fit in Sunbrite cases.
- Full dimensions (width / height / depth) with mounting brackets:
 - DMP-2K**
 - 196.20 mm / 37.00 mm / 169.45 mm
 - 7.72 in / 1.46 in / 6.67 in
 - SV-4K**
 - 196.20 mm / 61.65 mm / 169.45 mm
 - 7.72 in / 2.43 in / 6.67 in
 - The bracket length is 164.15 mm / 6.46 in.
- Weight:
 - DMP-2K: 1 lb 14 oz / 850.5 grams
 - SV-4K: 2 lb 4 oz / 1020.6 grams
- Attach to the wall using the brackets on each side of the device using 4 screws (one for each bracket slot) that measure between 3.5 mm and 4.2 mm in diameter.
- Do not block the right side panel so that you can see the LEDs for troubleshooting.
- Ensure all air vents are clear for proper cooling.
- Choose a location that works with the required IR extender cable for infrared support. No IR receptor is built into the DMP.

Caution: Do not mount the DMP near where HVAC outlets or ducts may drip condensed air onto the device. Humid conditions are not recommended and may cause the unit to fail or behave unpredictably.

Note: The tested range is about 20 ft. To achieve this range, position the receiver facing outward. The receiver is enclosed and not visible.

Guidelines for Mounting the Series 3 Media Players

Consider the following guidelines before mounting a Series 3 media player:

- Full dimensions (width / height / depth) with mounting brackets:
 - CV-HD**
 - 160.00 mm / 21.00 mm / 144.44 mm
 - 6.30 in / 0.83 in / 5.69 in
 - The mounting holes are inset 20.98 mm (0.82 in) from the box edge.
 - CV-UHD**
 - 204.35 mm / 21.00 mm / 179.92 mm

Physical Characteristics of the Digital Media Players

- 7.08 in / 0.83 in / 7.08 in
- The mounting holes are inset 30.94 mm (1.22 in) from the box edge.
- **Weight:**
 - CV-HD: 12 oz / 340.1 grams
 - CV-UHD: 1 lb 4 oz / 567 grams
- Attach to the wall using the mounting holes on the front and back with 4 screws (one for each hole) that measure between 3.5 mm and 4.2 mm in diameter.
- Ensure all air vents are clear for proper cooling.
- Choose a location that works with the required IR extender cable for infrared support. No IR receptor is built into the DMP.

Caution: Do not mount the DMP near where HVAC outlets or ducts may drip condensed air onto the device. Humid conditions are not recommended and may cause the unit to fail or behave unpredictably.

Note: The tested range is about 20 ft. To achieve this range, position the receiver facing outward. The receiver is enclosed and not visible.

Guidelines for Mounting the Series 4 Media Players

Consider the following guidelines before mounting a Series 4 media player:

- Full dimensions (width / height / depth) with mounting brackets:

CV-HD2

- 159.92 mm / 21.00 mm / 144.15 mm
- 6.29 in / 0.83 in / 5.67 in
- The mounting holes are inset 25.93 mm (1.02 in) from the box edge.

CV-UHD2

- 179.92 mm / 21.00 mm / 204.36 mm
- 7.08 in / 0.83 in / 8.04 in
- The mounting holes are inset 25.94 mm (1.02 in) from the box edge.

- **Weight:**
 - CV-HD2: 12 oz / 340.1 grams
 - CV-UHD2: 1 lb 4 oz / 567 grams
- Attach to the wall using the mounting holes on the front and back with 4 screws (one for each hole) that measure between 3.5 mm and 4.2 mm in diameter.
- Ensure all air vents are clear for proper cooling.
- Choose a location that works with the required IR extender cable for infrared support. No IR receptor is built into the DMP.

Caution: Do not mount the DMP near where HVAC outlets or ducts may drip condensed air onto the device. Humid conditions are not recommended and may cause the unit to fail or behave unpredictably.

Physical Characteristics of the Digital Media Players

Note: The tested range is about 20 ft. To achieve this range, position the receiver facing outward. The receiver is enclosed and not visible.

LEDs on the Digital Media Players

LEDs on the Series 2 Media Players

The Series 2 media players have 8 LEDs in two banks of 4 on the right panel of the device. [Figure 20 on page 34](#) shows normal operation for the device on a Cisco Vision Dynamic Signage Director network.

Note: Some of the LEDs apply to hardware features that are not enabled for use with Cisco Vision Dynamic Signage Director.

Figure 20 Series 2 Media Player LED Bank

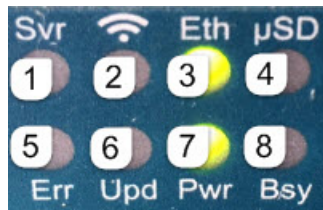

1	Svr —Not applicable.	2	WiFi —(SV-4K only) Flashes when the player is connecting to the wireless network. Displays when connected.
3	Eth (green)—Flashes when connecting to Ethernet network. Displays when connected.	4	μSD —Not applicable.
5	Err (red)—Flashes a certain number of times to indicate errors (Table 19 on page 34).	6	Upd (yellow)—Flashes when the device is being upgraded. The Update and Error LEDs will flash in unison to indicate an error during firmware update (Table 20 on page 35).
7	Pwr (green)—Displays when the device is powered on and not in reset mode.	8	Bsy (green)—Flashes when there is file-system activity.

Table 19 Error (Err) LED Descriptions on the Series 2 Media Player

Error LED (number of flashes)	Description
2	Unspecified error.
3	Device is in network recovery mode and using DHCP Option 43 to contact Cisco Vision Dynamic Signage Director for provisioning.
4	No upgrade file found.
5	Failed to load kernel module. or OS initialization failed (Init shell script failed).
6	Board is not capable of running the current firmware version.
7	A piece of on-board hardware is not working correctly.
8	(Not applicable) Problem related to storage device (USB or SD card).
9	Problem related to the registry/NAND.
10	The autorun script encountered a load/run error.
11	WiFi-related error.

Table 19 Error (Err) LED Descriptions on the Series 2 Media Player (continued)

Error LED (number of flashes)	Description
12	Unable to find a bootable image.
13	The root file system has failed verification, which is used to detect whether the file system has been tampered with. You can recover a unit that is showing this error code by performing an update using safe mode.
14	Boot loader failure.

Table 20 Update (Upd) LED Descriptions on the Series 2 Media Player

Error LED (number of flashes)	Description
2	Erase failed.
3	Write failed.
4	Verify failed.
5	Failed to find UBI partition.
6	Attempt to write unsigned CFE to unit with secure boot enabled.
7	Failed to find UBI partition.
8	Failed to create/attach UBI partition.
9	Unexpected error.
10	Upgrade script exited abnormally.
11	Upgrade took longer than expected.
12	Update completed but update file could not be deleted.

LEDs on the Series 3 Media Players

The Series 3 media players have one row of LEDs on the left front panel of the device. The CV-UHD media player has an extra LED for WiFi support (Figure 21 on page 36).

Figure 21 Series 3 LED Bank

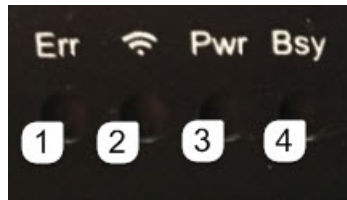

1	Err (red)—Flashes a certain number of times to indicate errors (Table 21 on page 36).	2	WiFi —(CV-UHD only) Flashes when the player is connecting to the wireless network. Displays when connected. Note: WiFi support is an orderable option for the CV-UHD only. It is not shipped by default in the media player.
3	Pwr (green)—Displays when the board is powered up and not in reset mode. Flashes during the firmware update process.	4	Bsy (green)—Flashes when there is file-system activity.

Table 21 Error (Err) LED Descriptions on the Series 3 Media Player

Error LED (number of flashes)	Description
2	Unspecified error.
3	Device is in network recovery mode and using DHCP Option 43 to contact Cisco Vision Dynamic Signage Director for provisioning.
4	No upgrade file found.
5	Failed to load kernel module. or OS initialization failed (Init shell script failed).
6	Board is not capable of running the current firmware version.
7	A piece of on-board hardware is not working correctly.
8	Problem related to USB device or SD card.
9	Problem related to the registry/NAND.
10	The autorun script encountered a load/run error.
11	WiFi-related error.
12	Unable to find a bootable image.

LEDs on the Series 4 Media Players

The Series 4 digital media players have one row of LEDs on the front panel of the device.

Table 22 Error (Err) LED Descriptions on the Series 4 Media Player

Error LED (number of flashes)	Description
2	Unspecified error.
3	Device is in network recovery mode and using DHCP Option 43 to contact Cisco Vision Dynamic Signage Director for provisioning.
4	No upgrade file found.
5	Failed to load kernel module. or OS initialization failed (Init shell script failed).
6	Board is not capable of running the current firmware version.
7	A piece of on-board hardware is not working correctly.
8	(Not applicable) Problem related to storage device (USB or SD card).
9	Problem related to the registry/NAND.
10	The autorun script encountered a load/run error.
11	WiFi-related error.
12	Unable to find a bootable image.

IR Remote for Cisco Vision Dynamic Signage Director

All media players use the same IR Remote device shown in [Figure 22 on page 38](#). Generally, the IR Remote is used for TV control. However, even if you are not using the IR Remote for TV control, it is important to realize that the IR Remote also allows you to get information to troubleshoot the media player.

Note: The IR Remote is not automatically shipped with the Cisco Vision Dynamic Signage Director media players and must be ordered separately. To order an IR Remote control device, please contact your Cisco Sales Representative for available IR Remote solutions.

[Figure 22 on page 38](#) shows the description for each of the buttons on the Cisco Vision Dynamic Signage Director IR Remote.

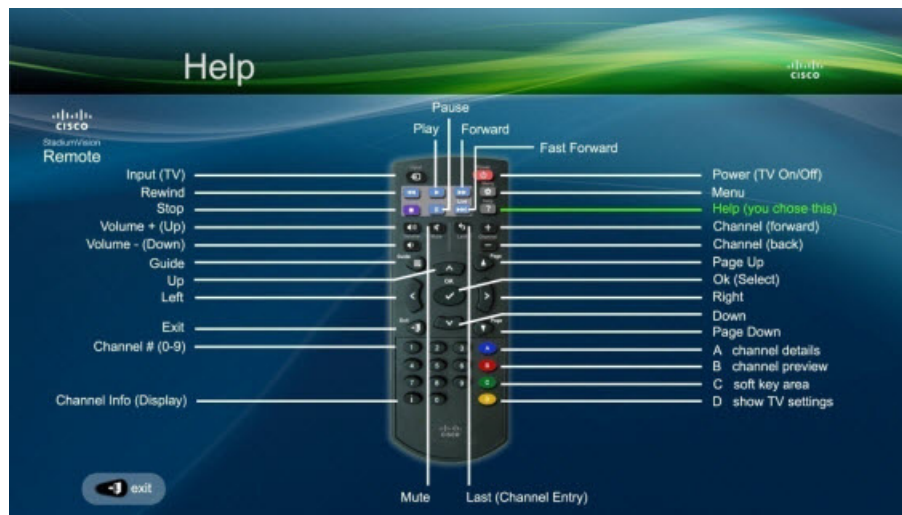
Figure 22 Cisco Vision Dynamic Signage Director IR Remote Button Descriptions

IR Remote Sensor and IR Extender

Unlike for the Cisco DMP 4310G, the Series 2, Series 3, and Series 4 digital media players do not have their own IR receiver. An IR extender is required. For more information, see [Mounting Guidelines for the Digital Media Players](#), page 30.

The IR remote also is a critical troubleshooting tool so it is important to ensure that all media players can be IR-controlled even if it is not needed during normal operation. For more information about the IR-Remote, contact your Cisco Sales Representative for available IR Remote solutions.

Default Settings for the Digital Media Player

The devices ship from the factory with certain default settings. Upon running the start-up sequence and in communication with Cisco Vision Dynamic Signage Director, the Series 2, Series 3, and Series 4 default settings are changed.

RS-232 Default Settings on the DMPs

After processing the HTML run-time module from Cisco Vision Dynamic Signage Director, the DMP is set to the following RS-232 default settings:

Note: The DMPs use default settings that match most TVs.

- Baud—9600 (factory default is 115200)
- Parity—None
- Data Bits—8
- Stop Bits—1
- Flow Control—None (factory default is hardware flow control only)

For information about the new RS-232 commands for the DMPs, see [Appendix B: Display Parameters for the Digital Media Players](#), page 79.

Other Default Settings

By default, the following functionality is disabled on the Series 2, Series 3, and Series 4 media player:

- Secure Shell (SSH)

Feature Summary for the Digital Media Player

This section includes the following topics:

- [Cisco Vision Dynamic Signage Director Software Feature Map for the DMPs, page 39](#)
- [Unsupported DMP Hardware Features, page 40](#)

Cisco Vision Dynamic Signage Director Software Feature Map for the DMPs

The following table identifies a subset of features that are supported only by certain DMP models in Cisco Vision Dynamic Signage Director.

Table 23 DMP-Specific Feature Map

Feature	Series 2 DMP-2K SV-4K		Series 3 CV-HD & CV-UHD		Series 4 CV-HD2 & CV-UHD2	
	No	Yes	No	Yes	Yes	Yes
UHD Local Video	No	Yes	No	Yes	Yes	Yes
Dual Video ¹ with Luma Key (applied to secondary HD video region over an HD or 4K video in the primary region)	Yes	Yes	No	Yes	No	Yes
HDMI-In as a Channel Source ²	No	Yes	No	Yes	No	Yes
Video Streamed to a Local HDMI-In Channel (HDMI-In Pass-Through) ³	No	Yes	No	Yes	No	Yes
WiFi support	No	Yes	No	(Optional) ⁴	No	No

1. Dual UHD resolution video regions is not supported.
2. Enhanced in Release 6.0 to add a default HDMI-In Channel 0.
3. For HDCP-compliant devices and content.
4. The CV-UHD WiFi model supports WiFi.

The following table identifies the globally-supported features for all media players in the release.

Table 24 Globally Supported Features for DMPs

Feature	Series 2	Series 3	Series 4
2.1 AC3/AC3+ (Dolby Digital audio decode)	Yes	Yes	Yes
5.1 Dolby plus/AC3	No	Yes	Yes
Auto-Registration	Yes	Yes	Yes
Bulk Administration Tool (BAT)	Yes	Yes	Yes
Closed Caption	Yes	Yes	Yes
Command Center Monitoring	Yes	Yes	Yes

Table 24 Globally Supported Features (continued) for DMPs

Feature	Series 2	Series 3	Series 4
Content Replacement	Yes	Yes	Yes
Content Synchronization (between same media player models only)	Yes	Yes	Yes
Custom Fonts (through Software Manager)	Yes	Yes	Yes
External Content Integration	Yes	Yes	Yes
Event Script Scheduler	Yes	Yes	Yes
HDMI Encoding ¹	SV-4K only	CV-UHD only	CV-UHD2 only
HTML Pages as a Multicast Channel (from external URL) ³	Yes	Yes	Yes
HTTP Live Streaming (HLS) Video as a Multicast Channel (from external URL) ³	Yes	Yes	Yes
Group/Zone Configuration	Yes	Yes	Yes
System Configuration Commands	Yes	Yes	Yes
System Configuration Firmware Configuration	Yes	Yes	Yes
Device Management Model Filtering	Yes	Yes	Yes
Device Management Monitoring	Yes	Yes	Yes
Multicast Video Scaling	Yes	Yes	Yes
Network Time Protocol (NTP) Configuration	Yes	Yes	Yes
Point of Sale (POS) Integration with DMB Using Widgets	Yes	Yes	Yes
Portrait Mode content renditions ²	Yes	Yes	Yes
Precision Time Protocol (PTP) configuration	Yes	Yes	Yes
Proof of Play (PoP)	Yes	Yes	Yes
Touch Screen ³	Yes	Yes	Yes
TV Control using RS-232 and IR Remote	Yes	Yes	Yes
Basic TV Control using HDMI CEC	Yes	Yes	Yes
Video Encoded as a a Multicast Channel from DMP Display Source (Display Encoding) ³	Yes	Yes	Yes
Video Upload Support for Files Up to 4 GB in Size	Yes	Yes	Yes
Widgets	Yes	Yes	Yes

1. HDMI encoding only works on SV-4K, CV-UHD, and CV-UHD2 DMPs.

2. Not recommended when rendering video on CV-HD and CV-HD2 DMPs.

3. Introduced in Release 6.0.

Unsupported DMP Hardware Features

The following DMP hardware features are not supported:

- SD (and microSD, included with CV-HD2 only, as a factory-installed component)
- USB (3.0)—only used to connect HID-compliant touchscreen devices

Note: The DMPs do not support content import and/or playback using the SD card or USB ports.

Key Considerations for the Digital Media Players

When you deploy a digital media player, there are several things that you should know about its operation. This section highlights some of the important differences to be aware of when deploying the digital media players.

This section includes the following topics:

- [Firmware Provisioning on the DMPs, page 41](#)
- [Auto-Provisioning on the Digital Media Players, page 42](#)
- [HDCP Support on the Digital Media Players, page 42](#)
- [IR Receiver for the Digital Media Players, page 42](#)
- [Storage and Memory on the Digital Media Players, page 42](#)
- [Synchronization on the Digital Media Players, page 43](#)
- [Switch Communication on the Digital Media Players, page 43](#)
- [WiFi Network Connectivity on the CV-UHD and SV-4K DMPs, page 43](#)

Firmware Provisioning on the DMPs

The DMP firmware upgrade cannot be manually launched in the **Configuration > System Configuration** DMP command. It is done automatically when the device boots.

Caution: Before you power on the Series 2, Series 3, and Series 4 device for the first time, complete the following configuration and tasks:

For initial deployment of a DMP, verify:

- No other accessories are attached to the DMP.
- Use standard Category 5e or 6 cables up to 100 m in length.
- Switch configuration, including the required LLDP for proper PoE+ operation. LLDP and POE+ not required for CV-HD/CV-HD2 players.
- DHCP server configuration, including the proper option 43 string.
- Firmware upload for your Cisco Vision Dynamic Signage Director release.
- Auto-registration settings for the DMP to properly provision its firmware.

[Table 25 on page 41](#) provides a summary of the firmware provisioning tasks for the DMP in the **System Configuration > Configuration**.

Table 25 Summary of Firmware Provisioning Tasks on the Media Players

Firmware Provisioning Task	DMP
Upload firmware to Cisco Vision Dynamic Signage Director in the System Configuration > Configuration .	Yes
Configure "Firmware image to use" and "init.version" under Auto Registration Settings.	Yes
Upgrade the firmware from the System Configuration > Configuration by selecting DMPs and running the Firmware Upgrade command to push the firmware to the device.	No

Auto-Provisioning on the Digital Media Players

- The digital media players are automatically provisioned with global configuration settings from Cisco Vision Dynamic Signage Director.
- As part of the start-up sequence, the device retrieves the Cisco Vision Dynamic Signage Director configuration, which includes all of the global settings for the devices, such as NTP configuration, jitter settings, and so on.

To configure DMP global settings:

Click **Configuration > System Configuration > Global DMP Settings**.

To configure DMP auto-registration settings:

Click **Configuration > System Configuration > Auto Registration Settings**.

- The DMP configuration in Cisco Vision Dynamic Signage Director is provisioned each time that the device boots.

Caution: When running Cisco Vision Dynamic Signage Director on a virtual server, reference a reliable NTP server. NTP for Cisco Vision Dynamic Signage Director is configured using the TUI. For more information, see [Cisco Vision Administration Guide: Dynamic Signage Director Release 6.3](#).

HDCP Support on the Digital Media Players

The DMPs natively support content that uses Intel's High-bandwidth Digital Content Protection (HDCP) through the installation of a protection key on the digital media player.

- From the HDMI Out port, the DMPs support HDCP versions 1.4.
- From the HDMI In port, the SV-4K, CV-UHD, and CV-UHD2 can receive HDCP 1.4.

IR Receiver for the Digital Media Players

There is not an embedded IR receiver on the digital media players. Use the IR extender cable to use the IR Remote.

Storage and Memory on the Digital Media Players

The DMP devices have different sizes of solid-state storage and RAM ([Table 26 on page 42](#)):

Table 26 Storage and Memory on the Digital Media Players

DMP Model	Usable Storage Space	Total RAM
CV-HD2	120 GB	2 GB
CV-UHD2	120 GB	4 GB
CV-HD	100 GB	3 GB
CV-UHD	100 GB	3 GB
SV-4K	100 GB	3 GB
DMP-2K	53 GB	2 GB

Note: The amount of RAM can make a difference in how the same content might play on different media player models. This difference might more likely be seen when playing HTML pass-through (URL) content.

To find information about available storage:

1. Click **Device Management > All Devices**.
2. Select a device.

3. In the **Status** tab, go to **Status Details** or **Utilization**.

Note: The amount of available storage shown in **Device Management** reflects the total amount of space available on the SSD, not the actual storage pool available for content.

You also can find information about available storage if you view **Device Details** by clicking a screen from thumbnail view in **Device Management** (CCM).

Synchronization on the Digital Media Players

The digital media players support synchronization of content played among a group of devices using the Network Time Protocol (NTP) and Precision Time Protocol (PTP). NTP and PTP settings are provisioned globally for all digital media players.

The Cisco Vision Dynamic Signage Director server is provisioned as the default NTP source for all media players. When PTP is configured, only the PTP leader derives its clock using NTP.

Caution: When running Cisco Vision Dynamic Signage Director on a virtual server, reference a reliable NTP server. NTP for Cisco Vision Dynamic Signage Director is configured using the TUI. For more information, see [Cisco Vision Administration Guide: Dynamic Signage Director Release 6.3](#).

Switch Communication on the Digital Media Players

The digital media players communicate with the Cisco Connected Stadium switch using the required Link Layer Discovery Protocol (LLDP) rather than MediaNet. The media player determines available power (when using PoE+) over LLDP.

WiFi Network Connectivity on the CV-UHD and SV-4K DMPs

Wireless network connectivity to the CV-UHD or SV-4K is supported over an 802.11a, 802.11b, or 802.11n wireless network in the Cisco Vision Dynamic Signage Director venue.

Note: For initial deployment of a DMP with WiFi connectivity, you will need both a PoE+ network connection in addition to connection of the CV-UHD or SV-4K using the DMP power supply adapter. After the DMP is deployed for WiFi, a PoE+ connection is no longer needed for the DMP. In fact, the DMP will not route packets over the WiFi connection while the Ethernet port is connected and operational.

The wireless network SSID and passphrase is configured globally for all wireless devices in the system. The DMP firmware automatically tries to connect with WEP (if the passphrase is of a suitable length), WPA1 or WPA2.

For configuration information, see [How to Deploy WiFi Network Connectivity on the SV-4K](#).

Notes:

Multicast video is not supported due to bandwidth limitations over a wireless network.

For non-video control for the DMPs, one of these two options must be valid:

- The wireless network must support multicast traffic for communication over the Cisco Vision Dynamic Signage Director network.
- The DMPs must be configured to use the new Unicast Deployment functionality.

Best Practices for DMP Deployment

Using Bar Code Scanners and TV Labels at Installation Time

Note: This practice requires that you have already defined your Location names in Cisco Vision Dynamic Signage Director.

To increase the speed and accuracy of media player deployment:

- Prepare TV labels with the Cisco Vision Dynamic Signage Director Location name in bar code format.
- Obtain a bar code scanner to record the Location bar code and MAC address from the media player.
- Use the [Cisco Vision Director Bulk Administration Tool \(BAT\)](#) to upload data to Cisco Vision Dynamic Signage Director.

Installer Workflow Example

To use a bar code scanner with TV labels:

1. Mount the TV and media player.
2. Connect the TV and media player cables.
3. Attach a pre-printed label to TV.
4. Scan the Location bar code on the TV.
5. Scan the MAC address bar code on the media player.
6. Provide scanner to the supervisor or network administrator who downloads the data and formats it to be compatible with the Cisco Vision Dynamic Signage Director BAT TSV format.
7. For more information, see the [Cisco Vision Director Bulk Administration Tool](#) guide.



Planning Digital Media Player Deployment

Series 2 DMPs: DMP-2K and SV-4K

Series 3 DMPs: CV-HD and CV-UHD

Series 4 DMPs: CV-HD2 and CV-UHD2

This module describes aspects of the DMP deployment to consider and execute—before you install and provision the digital media players. It is for installers, network administrators, and administrators of Cisco Vision Dynamic Signage Director.

This module includes the following topics:

- [Workflow to Plan Deployment of the Digital Media Players, page 45](#)
- [Zones, Groups and Locations Planning, page 46](#)
- [TV Planning for the Digital Media Player, page 46](#)
- [Network and Switch Planning, page 49](#)

Workflow to Plan Deployment of the Digital Media Players

[Table 1 on page 45](#) provides a summary of the tasks and related information to plan for the deployment of the digital media player.

Table 1 Deployment Planning Task Summary

Planning Task	For more information see:
Plan Groups/Zones/Locations.	Zones, Groups and Locations Planning, page 46.
Perform TV qualification.	<ul style="list-style-type: none">■ TV Requirements for Compliance, page 46.■ TV Qualification for HDMI CEC Control of TV Power On/Off, page 46.■ Guidelines for TV and Content Resolution with the Digital Media Players, page 47.
Prepare for SV-4K and DMP-2K installation (Series 2). Prepare for CV-HD and CV-UHD installation (Series 3). Prepare for CV-HD2 and CV-UHD2 installation (Series 4).	<ul style="list-style-type: none">■ Using Bar Code Scanners and TV Labels at Installation Time, page 44.■ Mounting Guidelines for the Digital Media Players, page 30
Determine cabling requirements.	<ul style="list-style-type: none">■ Best Practices for DMP Deployment, page 44.■ Cabling Information for the Digital Media Player, page 28.

Table 1 Deployment Planning Task Summary (continued)

Planning Task	For more information see:
Plan the Connected Stadium switch configuration.	Connected Stadium Switch Requirements, page 50.
Plan the DHCP server configuration.	External DHCP Server Requirements, page 49.
Determine the network time (clocking) sources.	How to Configure NTP and PTP on the Digital Media Players, page 56.

Zones, Groups and Locations Planning

Note: We do not recommend mixed groups that contain different media player device types. Cisco Vision Dynamic Signage Director gives a warning about such groups if you attempt to configure them.

TV Planning for the Digital Media Player

This section includes the following topics:

- [TV Requirements for Compliance, page 46](#)
- [TV Qualification for HDMI CEC Control of TV Power On/Off, page 46](#)
- [Guidelines for TV and Content Resolution with the Digital Media Players, page 47](#)
- [Restrictions for TV Display Specifications with the Digital Media Players, page 47](#)
- [Configuring Resolution Display Specifications, page 47](#)

TV Requirements for Compliance

For the optimal experience with the digital media player, verify the site TV displays are compliant with the following specifications and resolution:

- High-bandwidth Digital Content Protection (HDCP)
- High-Definition Multimedia Interface (HDMI)
- HDMI Consumer Electronics Control (CEC) (as required for TV control)
- RS-232 serial interface (as required)
- HD or UHD capable display

TV Qualification for HDMI CEC Control of TV Power On/Off

We introduced support for the universal TV power on/off HDMI CEC command on the Cisco DMPs with a new **Display Specifications** configuration that allows you to control the following three TV functions through HDMI CEC:

- Power On/Off
- Reboot
- Refresh

When HDMI CEC TV control is enabled, HDMI CEC is used instead of RS-232 for TV control functions. For information about accessing and setting up this parameter, see [Configuring HDMI-CEC TV Control in TV Display Specifications](#) in the [Cisco Vision Dynamic Signage Director Operations Guide, Release 6.3.](#)

Note: Not all TVs support the standard HDMI CEC commands. Test the TV models that you plan to install for support of HDMI CEC and turn HDMI-CEC on. TV manufacturers refer to CEC by different trade names. (For example: Anynet+ [Samsung], BRAVIA Link [Sony], EasyLink [Phillips], and SimpLink [LG]).

For information about some of the TV models that have been tested with Cisco Vision Dynamic Signage Director, see [Release Notes for Cisco Vision Dynamic Signage Director, Release 6.3](#).

Guidelines for TV and Content Resolution with the Digital Media Players

The DMPs are set to run in full high-definition (HD) 1920x1080 mode by the runtime software.

Note: We highly recommend that your TV supports a minimum of 1080p HD resolution. Lower resolution displays might need some additional configuration of the TV Display Specification configuration in Cisco Vision Dynamic Signage Director to attempt to optimize the display. In some cases these TVs might cut off an area of the screen, rather than resize the graphics.

The quality and expected resolution for video and graphics display for the DMPs can be affected by several things:

- The resolution of the TV display and its ability to negotiate to 1080p.
- The configuration of the **sv4k.videoMode** serial command in the **Configuration > Devices > Display Specifications > Display Parameters** area of the Cisco Vision Dynamic Signage Director UI.
 - When set to a resolution, this value specifies the DMP signal resolution.
 - If the resolution is set to auto-detection, then the TV negotiates the signal resolution with the DMP, as long as the TV supports negotiation.

Note: If you are using a UHD display, you must configure a fixed resolution value of 3840x2160x60p in the **sv4k.videoMode** serial command in the TV **Display Specification**.

- The template region size.
- The size of the original graphic and whether any scaling needs to happen.

Note: For more information about content and template guidelines, see the [Cisco Vision Content Planning and Specification Guide: Dynamic Signage Director, Release 6.3](#).

Restrictions for TV Display Specifications with the Digital Media Players

Before you configure TV display specifications for use with the digital media players, consider the following restrictions:

- The following Basic Info options are not supported:
 - X Position / Y Position
 - X Scaling / Y Scaling

Configuring Resolution Display Specifications

The Display Specification for a TV can either be configured for auto-detection of resolution by the TV, or set to a fixed resolution. Go to **Configuration > Devices > Display Specifications** in the Cisco Vision Dynamic Signage Director UI.

Figure 1 Display Signal Resolution

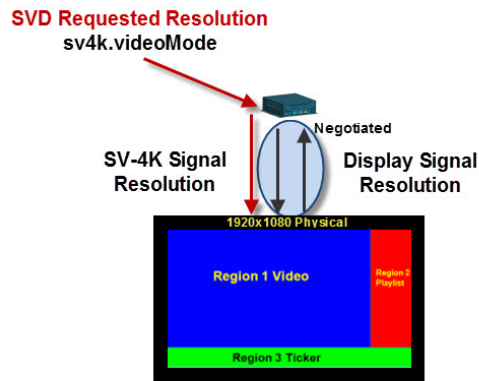

- If the resolution is set to auto-detection, then the TV and the DMPs negotiate the signal resolution, as long as the TV supports auto-negotiation (Figure 1 on page 48).
- If a resolution is specified in the Cisco Vision Director UI, then the content is resized according to that setting. This is the requested DMP signal resolution shown in red in Figure 1 on page 48.
- If the signal resolution of the DMP is set below 1920x1080 for any reason, video content will be resized according to the template in use.
- The template in use and the corresponding content must match the signal resolution.

Note: The sv4k.videoMode display parameter is unrelated and is not a required or expected configuration for use of portrait mode. In addition, only certain values are supported for sv4k.videoMode, and they should not be changed to any other values (Table 2 on page 49). Portrait mode is enabled and configured using the dmp.portrait display parameter only. However, when preparing your content for portrait mode, the content should be designed for 1920 pixels high and 1080 pixels wide. The default template canvas will still show horizontal orientation when you are using portrait mode, but you can add regions that extend beyond the canvas.

To set the resolution for a display:

1. Go to **Configuration > Devices > Display Specifications**.
2. Select the TV that you want to configure.
3. Click the **Display Parameters** tab.

- Find the `sv4k.videoMode` command (Figure 2 on page 49) and select it.

Figure 2 Resolution Setting in Display Specifications

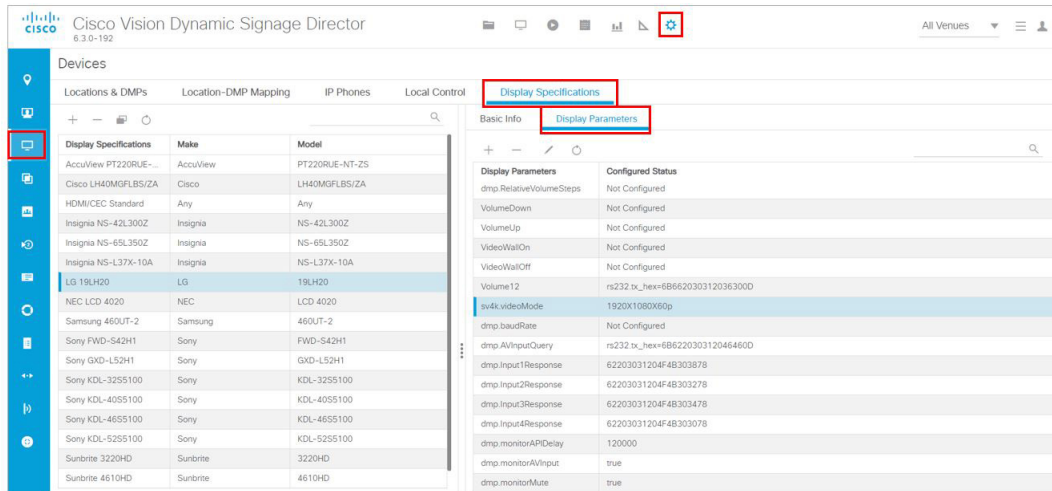

- Click the Edit “pencil” to add in the specs in the **Configured Status** field. Specify one of the values in Table 2 on page 49 according to the desired resolution behavior.

Table 2 DMP Resolution Values

sv4k.videoMode Value ¹	Resolution
3840x2160x60p ²	Fixed at 2160p
1920x1080x60p	Fixed at 1080p
1280x720x60p	Fixed at 720p
Not Configured	Auto-detected
Auto	Auto-detected

- Do not use any values other than what are listed in this table. There is no specific `sv4k.videoMode` resolution that is required to support portrait mode. Portrait mode is configured only through the `dmp.portrait` display parameter.
- This specification is required for 4K TV displays in Release 4.1.

- Click **Save**.
- Reboot the DMP.

Network and Switch Planning

This section includes the following topics:

- External DHCP Server Requirements, page 49
- Connected Stadium Switch Requirements, page 50

External DHCP Server Requirements

The digital medias player require configuration of an external DHCP server to provide IP addressing to the devices. This service can be configured using Cisco Prime Network Registrar (CPNR) or another external server at the venue.

This section highlights some of the key requirements to plan your DHCP configuration. However, it does not describe all of the details for you to perform the configuration.

Note: For more information and details about DHCP configuration, see the [Cisco Vision Network, Server, and Video Headend Requirements Guide](#) available to qualified Cisco Vision partners.

DHCP Configuration Guidelines for the Digital Media Player

Consider the following guidelines before configuring a DHCP server for the DMPs:

- Do not configure the Connected Stadium Switch as the IOS DHCP server for Cisco Vision Dynamic Signage Director.
- Be sure to set the DHCP server for an infinite lease of IP addresses to the DMP devices.
- If you are supporting a deployment with mixed models of media players, configure an Option 60 string for each model.
- If the DHCP server is limited to a single Option 43 string per DHCP pool (such as with a Cisco DHCP server), configure a separate DHCP scope for each media player model.
- For DHCP servers that require Option 60, configure the DHCP Option 60, Vendor Class Identifier string:
 - CV-HD2 global string: “Cisco CV-HD2”
 - CV-UHD2: “Cisco CV-UHD2”
 - CV-HD global string: “Cisco CV-HD”
 - CV-UHD global string: “Cisco CV-UHD”
 - CV-UHD with WiFi global string: “Cisco CV-UHD-WiFi”
 - DMP-2K string for new, factory-shipped devices: “Cisco DMP-2K”
 - SV-4K string for North America: “Cisco SV-4K-NA”
 - SV-4K string for all other regions: “Cisco SV-4K-ROW”
- Configure the converted DHCP Option 43, Vendor Specific Option URL:
`http://x.x.x.x:8080/CiscoVision/dmp_v4/scripts/boot.brs`
where “x.x.x.x” is the IP address of the Dynamic Signage Director server.

Note: The option 43 string must be converted to TLV format for compatibility with the DMPs. For more information, see [Appendix C: Configuring an IOS DHCP Server to Support the Digital Media Players, page 83](#).

Connected Stadium Switch Requirements

This section highlights some of the key requirements to plan your Connected Stadium switch configuration. However, it does not describe all of the details for you to perform the configuration. For configuration details, see the [Cisco Vision Network, Server, and Video Headend Requirements Guide](#) available to qualified Cisco Vision partners.

Switch Configuration Requirements for the Digital Media Player

Be sure that the Connected Stadium switch meets the following configuration requirements to support the deployment of the digital media players:

- For SV-4K, CV-UHD, and CV-UHD2: supports PoE+ (IEEE 802.3at) with 30W of port power.
- For DMP-2K, CV-HD, and CV-HD2: supports PoE+ (IEEE 802.at) with 15W of port power.

Network and Switch Planning

- Configures Internet Group Management Protocol (IGMP).
- IGMPv2, and IGMPv3 are supported.
- Configures Link Layer Discovery Protocol (LLDP), which is required to determine available power using PoE+ and also supports the IOS Civic Location feature.

Note: For more information and details about the switch configuration, see the [Cisco Vision Network, Server, and Video Headend Requirements Guide](#) available to qualified Cisco Vision partners.

Note: When only 15W is available, the USB ports will retain I/O functionality but limit power output to 100 mA / port. Additionally, HDMI-In is not supported and graphics performance will be reduced.



Deploying the Digital Media Players

Series 2 DMPs: DMP-2K and SV-4K

Series 3 DMPs: CV-HD and CV-UHD

Series 4 DMPs: CV-HD2 and CV-UHD2

This module describes the workflow and tasks to deploy the digital media player. It is intended for Cisco Vision Dynamic Signage Director administrators and installers.

It includes the following topics:

- [Prerequisites for DMP Deployment, page 53](#)
- [Workflow Summary to Deploy the Digital Media Player for the First Time, page 53](#)
- [Configuring the DMP Global Settings, page 54](#)

Prerequisites for DMP Deployment

Before you deploy digital media players, be sure that the following requirements are met:

- The pre-deployment tasks are completed. For more information, see [Planning Digital Media Player Deployment, page 45](#).
- The hardware is not yet powered up.

Workflow Summary to Deploy the Digital Media Player for the First Time

[Table 1 on page 54](#) provides a summary of the tasks and related information to deploy the DMPs.

Caution: Follow the order of deployment tasks provided in [Table 1 on page 54](#) so the DMP can be properly provisioned.

Table 1 DMP Deployment Task Workflow

Deployment Task	For more information see:
Configure the Connected Stadium switch for DMP operation (LLDP, IGMP).	<ul style="list-style-type: none"> ■ Connected Stadium Switch Requirements, page 50. ■ For details about the configuration, see the Cisco Vision Network, Server, and Video Headend Requirements Guide available to qualified Cisco Vision partners.
Configure the DHCP server with Option 60 and Option 43.	<ul style="list-style-type: none"> ■ For requirements, see External DHCP Server Requirements, page 49. ■ For Cisco CNR configuration, see the Cisco Vision Network, Server, and Video Headend Requirements Guide available to qualified Cisco Vision partners.
(Mandatory) Read and understand the firmware and auto-registration process for the digital media players.	<ul style="list-style-type: none"> ■ Release Notes for Cisco Vision Dynamic Signage Director Release 6.3. ■ Cisco Vision Software Installation and Upgrade Guide: Dynamic Signage Director Release 6.3.
Obtain the firmware.	<p>Refer to the following topics in Upgrading the DMP Firmware:</p> <ul style="list-style-type: none"> ■ “Downloading the Firmware for all Media Players” ■ “Uploading the DMP Firmware to Cisco Vision Dynamic Signage Director”
Configure <i>base</i> and <i>production</i> firmware settings for auto-registration.	“Configuring the DMPs for Auto-Registration” topic in Upgrading the DMP Firmware .
Configure global DMP settings.	Configuring the DMP Global Settings, page 54
Power on the device.	–
Verify the startup sequence.	Verifying the DMP Startup Sequence, page 61

Configuring the DMP Global Settings

This section includes the following topics:

- [Time Protocols and Synchronization on the Digital Media Players, page 54](#)
- [How to Configure NTP and PTP on the Digital Media Players, page 56](#)

Time Protocols and Synchronization on the Digital Media Players

This section includes the following topics:

- [Network Time Sources for the Digital Media Players, page 55](#)
- [PTP Leader and Members, page 55](#)
- [DMP-to-DMP Content Synchronization, page 55](#)
- [Zone-Based Video Wall Synchronization, page 55](#)

- [Use Cases for Video DMP-to-DMP Synchronization with PTP, page 55](#)

Network Time Sources for the Digital Media Players

The DMP supports two different network time sources under the global DMP settings:

- Network Time Protocol (NTP)—This is the default.
- Precision Time Protocol (PTP)—Required for video wall synchronization feature and for DMP-to-DMP synchronization.

NTP and PTP settings are provisioned globally for all digital media players. The Cisco Vision Dynamic Signage Director server is provisioned as the default NTP source for all media players.

Note: When PTP is configured, only the DMP PTP leader derives its clock using NTP.

For the most accurate synchronization for video playback across DMP devices, the time on the target media players must be almost the same. NTP does not provide this level of time synchronization and accuracy, so PTP is also required.

PTP Leader and Members

The DMP is capable to serve as a PTP leader or as a PTP member, where members obtain their time from the leader. The PTP leader, in turn, will get its time from an NTP server.

By default, all DMP devices are designated as eligible leader candidates.

DMP-to-DMP Content Synchronization

The DMP-to-DMP Content Synchronization feature for the digital media player synchronizes content rendering of playlist items on the displays.

This synchronization includes transitioning from one item to the next (such as for still images), and more accurate playback and rendering of local video content. For local video, this serves as the foundation for implementing video ribbon boards and video walls. This requires cabling of a single media player per display.

Note: Widgets, external URLs, and multicast video tuning synchronization are outside the scope of this feature.

Zone-Based Video Wall Synchronization

Zone-based video wall synchronization is an alternative form of synchronization available for DMP devices participating in a video wall. It makes use of a mechanism native to the DMPs that helps a group of media players stay in content sync with a leader device over multicast.

The primary benefit of this form of synchronization is that if any DMP device that is not the leader in the video wall reboots, it will “catch up” to play whatever content item that the rest of the video wall is currently playing.

If a DMP device reboots in a video wall that is not using zone-based video wall synchronization (using normal DMP-to-DMP synchronization), the trade-off is that the rebooting device synchronizes with the rest of the video wall at the next content item in the playlist, or at replay of a single-item playlist.

The general guideline is to use zone-based video wall synchronization for dedicated video walls that are playing video content longer than 15 minutes. While you can use this form of synchronization for all video walls, the synchronization benefit is best seen with longer-playing video wall content.

Use Cases for Video DMP-to-DMP Synchronization with PTP

PTP is particularly beneficial for the following use cases in the Cisco Vision Dynamic Signage Director network:

- Using video background for Dynamic Menu Boards (DMBs) that show primary and secondary regions of the event.
- Sponsored moment of exclusivity.
- When a team scores a goal, a secondary video using the luma key feature can be shown on screen overlaying a full screen video showing the live event.
- Video-based ads.
- Ads in region 2 or 3 (or L-wraps) can now be video content. For L-wraps, use the luma key so that the live multicast video displays.

How to Configure NTP and PTP on the Digital Media Players

By default, both NTP and PTP services are automatically enabled for digital media players. The digital media players use PTP to achieve optimal synchronization. However, an NTP source also must be used to provide initial clocking to the devices that are elected PTP leaders in the network.

This section includes the following topics:

- [Restrictions for PTP on the Digital Media Players, page 56](#)
- [Guidelines for NTP and PTP on the Digital Media Players, page 57](#)
- [Modifying the PTP and NTP Configuration on the Digital Media Players, page 58](#)
- [Verifying PTP Operation for the Digital Media Player, page 60](#)

Restrictions for PTP on the Digital Media Players

Before you configure PTP on the digital media players, consider the following restrictions:

- By default, PTP messages will not cross VLANs and PTP leader candidates need to be identified for each VLAN and configured in the **Configuration > System Configuration** page.
- The system supports a configurable Precision Time Protocol (PTP) Time To Live (TTL) setting in the **Configuration > System Configuration** page. The PTP TTL specifies the number of VLANs that can be crossed for selection of a PTP leader. The default value of 1 (recommended) means that each VLAN will elect its own PTP leader.

Note: For ease of configuration for venues with multiple VLANs, the system is configured by default to list all digital media players as eligible PTP leader candidates. However, be aware that although this simplifies configuration, the time that it takes for the devices to arbitrate a leader device in each network will vary, and depends on the number of eligible devices in each network.

- Content synchronization for video playback on the digital media players relies on precise time across DMPs using PTP. If the DMPs are playing video and one of the devices reboots, the rebooting unit will restart video playback from the beginning and will only synchronize with the other players when the next item in the playlist is rendered.
- If digital media players are participating in zone-based content synchronization for video walls, with some enhanced synchronization capability, the rebooting unit will synchronize with the current item being played by the device leader in the video wall. For more information, see “Working with Video Walls” in [Release 6.3: Cisco Vision Dynamic Signage Director Operations Guide](#).

Guidelines for NTP and PTP on the Digital Media Players

Before you configure NTP and PTP on the digital media players, consider the following guidelines:

- For new installations of Cisco Vision Dynamic Signage Director, PTP is the default time source for the digital media players, with NTP as the default time source for the elected PTP leader.

NTP Guidelines

- Each digital media player designated as PTP leader (per VLAN) will use NTP as its time source. The other devices in the network operate using a PTP reference clock from the elected PTP leader.
- When PTP is disabled (not recommended), all devices use NTP to set their local clock.

Note: For synchronized video playback, NTP alone cannot be relied upon for devices and PTP must be used.

- The default NTP synchronization interval with the host time server is one hour and is configurable.
- An NTP source must be configured in Cisco Vision Dynamic Signage Director. By default, the Cisco Vision Dynamic Signage Director server is configured as the device NTP host.

PTP Guidelines

- PTP version 2 is supported only for the digital media players and applies globally to all devices in the Cisco Vision Dynamic Signage Director network when configured.
- PTP configuration includes a PTP domain and a set of leader candidates:

- PTP domain—Default is 0.

Be sure that this domain does not conflict with any other PTP domain (and multicast addressing) in use in your network, and revise as needed. See table “Global DMP Settings—PTP Property Values” for more information.

- PTP leader candidates—Default is *.

This specifies that all devices in the network are eligible as leader candidates and will go through arbitration to designate a leader for their respective subnets.

- If you revise the default PTP leader candidates configuration, you must configure one or more devices as leader candidates in a semicolon-separated list of IP addresses for each VLAN.

A minimum of two leader candidates per network is recommended.

- If there is an in-house PTP leader for your network, leave the “PTP leader candidates” property value blank. However, this configuration is only supported for venues without multiple subnets.

Modifying the PTP and NTP Configuration on the Digital Media Players

By default the NTP and PTP services are automatically enabled and configured for digital media players. Use this task if you need to modify the default settings described in [Table 2 on page 58](#) and [Table 3 on page 59](#).

Table 2 Global DMP Settings–PTP Property Values

Property (Registry key)	Description	Values
PTP domain (Globaldmpsetting.common.init.ptp.domain)	Domain number for the PTP network, which defines the multicast address for PTP communication.	For IEEE-1588 PTP, possible values are: 0 –(Default) 224.0.1.129 1 –224.0.1.130 2 –224.0.1.131 3 –224.0.1.132
PTP leader candidates (Globaldmpsetting.common.init.ptp.master.host)	Eligible devices for leader candidate selection.	Possible values are: <ul style="list-style-type: none"> ■ *(Default). Wildcard pattern that specifies all devices in the network as eligible PTP leader candidates. ■ Semicolon-separated IPv4 addresses of the devices for each subnet. <p>Example: 10.0.0.3;10.0.0.4;192.168.0.5;192.168.0.6</p> <ul style="list-style-type: none"> ■ blank–Specifies that a PTP leader source external to Cisco Vision Dynamic Signage Director is used. This configuration is only valid for a venue without devices in multiple subnets.
PTP time-to-live (Globaldmpsetting.common.init.ptp.ttl)	Number of VLANs that can be crossed for selection of a PTP leader.	1 (Default) <p>Note: Best practice is to retain the default value of 1 for election of a PTP leader per video wall. With a TTL > 1, degradation in local video synchronization can occur.</p>

Note: If the domain setting gets blanked, it will disable PTP on all DMPs. The DMPs will revert to using NTP as the time source.

Table 3 Global DMP Settings–NTP Property Values

Property (Registry Key)	Description	Values
NTP Host (Globaldmpsetting.common.deploy.ntpc.hostname)	IPv4 address of the NTP server.	Default–IP address of the Cisco Vision Dynamic Signage Director server.
NTP sync interval (Globaldmpsetting.common.deploy.ntpc.interval)	Number of seconds that the device waits before trying to synchronize its time with the configured NTP host.	3600 (Default)
Timezone (Globaldmpsetting.common.deploy.ntpc.timezone)	Code for the timezone to be used.	GMT (Default)

To modify the standard NTP and PTP configuration on all DMPs:

1. Log into the Cisco Vision Dynamic Signage Director server as an administrator.
2. Click **Configuration > System Configuration > Global DMP Settings > Time Source** (Figure 1 on page 59).

Figure 1 Global DMP Settings for NTP and PTP on the DMPs

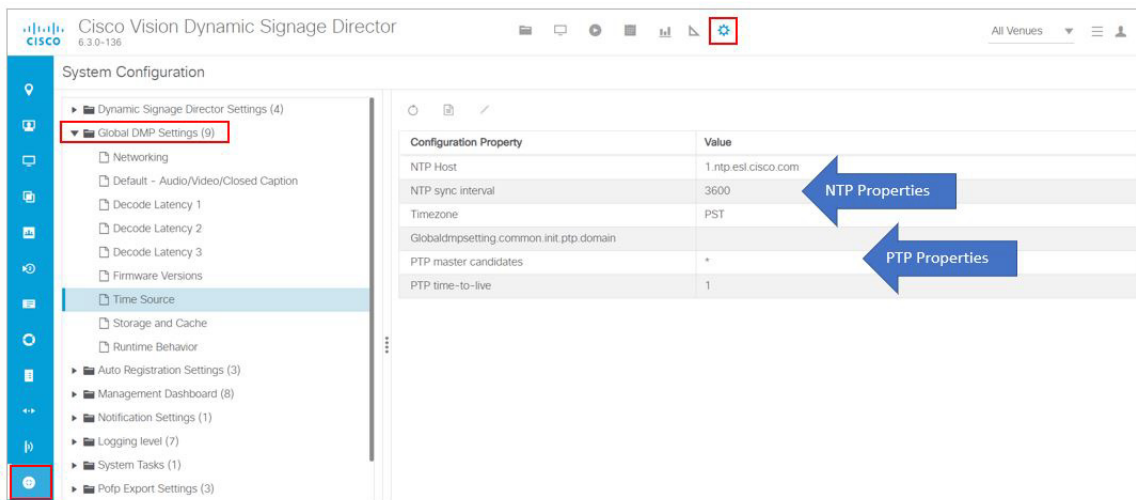

3. (Optional) Change the global PTP properties as required for your network. Click the **Edit** icon (pencil). Refer to Table 2 on page 58.
4. (Optional) Change the global NTP properties as required for your environment. Click the **Edit** icon (pencil). Refer to Table 3 on page 59.
5. Click **Save**.
6. Reboot the devices.

Verifying PTP Operation for the Digital Media Player

This section describes how to verify the PTP configuration and also the operation of PTP for your devices.

To verify the PTP operation for the digital media player:

1. Open your browser and navigate to one of the DMPs:

`http://sv4k-ip-address/ptp.html`

2. Identify the PTP leader by finding the unit that has an “offsetFromMaster” value of 0.0.

Figure 2 on page 60 highlights the PTP leader and shows a network where PTP is operating successfully with 12 members.

Figure 2 Successful PTP Clock Operation

PTP clock status

```

Status from local PTP:
sending: GET CURRENT_DATA_SET
90ac3f.ffe.038649-0 seq 0 RESPONSE MANAGMENT CURRENT_DATA_SET
stepsRemoved 0
offsetFromMaster 0.0 ←
meanPathDelay 0.0

Status from remote PTP devices:
sending: GET CURRENT_DATA_SET
90ac3f.ffe.03863d-1 seq 0 RESPONSE MANAGMENT CURRENT_DATA_SET
stepsRemoved 1
offsetFromMaster 333.0
meanPathDelay 12613.0
90ac3f.ffe.03863b-1 seq 0 RESPONSE MANAGMENT CURRENT_DATA_SET
stepsRemoved 1
offsetFromMaster -597.0
meanPathDelay 13332.0
90ac3f.ffe.03863c-1 seq 0 RESPONSE MANAGMENT CURRENT_DATA_SET
stepsRemoved 1
offsetFromMaster -366.0
meanPathDelay 13741.0
90ac3f.ffe.03863f-1 seq 0 RESPONSE MANAGMENT CURRENT_DATA_SET
stepsRemoved 1
offsetFromMaster 334.0
meanPathDelay 12543.0
90ac3f.ffe.03863e-1 seq 0 RESPONSE MANAGMENT CURRENT_DATA_SET
stepsRemoved 1
offsetFromMaster 849.0
meanPathDelay 13017.0
90ac3f.ffe.038641-1 seq 0 RESPONSE MANAGMENT CURRENT_DATA_SET
stepsRemoved 1
offsetFromMaster -323.0
meanPathDelay 13228.0
90ac3f.ffe.03864f-1 seq 0 RESPONSE MANAGMENT CURRENT_DATA_SET
stepsRemoved 1
offsetFromMaster 239.0
meanPathDelay 12560.0
90ac3f.ffe.038645-1 seq 0 RESPONSE MANAGMENT CURRENT_DATA_SET
stepsRemoved 1
offsetFromMaster 90.0
meanPathDelay 12642.0
90ac3f.ffe.038647-1 seq 0 RESPONSE MANAGMENT CURRENT_DATA_SET
stepsRemoved 1
offsetFromMaster 1328.0
meanPathDelay 13542.0
90ac3f.ffe.03863a-1 seq 0 RESPONSE MANAGMENT CURRENT_DATA_SET
stepsRemoved 1
offsetFromMaster 33.0
meanPathDelay 14068.0
90ac3f.ffe.038646-1 seq 0 RESPONSE MANAGMENT CURRENT_DATA_SET
stepsRemoved 1
offsetFromMaster -1768.0
meanPathDelay 14699.0

```



Verifying the Deployment of the Digital Media Player

Series 2 DMPs: DMP-2K and SV-4K

Series 3 DMPs: CV-HD and CV-UHD

Series 4 DMPs: CV-HD2 and CV-UHD2

This module includes the following topics:

- [Verifying the DMP Startup Sequence, page 61](#)
- [Startup Sequence Flow for the Digital Media Player, page 61](#)

Verifying the DMP Startup Sequence

Caution: Before you power on the DMP device for the first time, be sure that you have completed the following configuration and tasks:

- **For initial deployment of a DMP, be sure that:**
 - No other accessories are attached to the DMP.
 - You are using standard Category 5e or 6 cables up to 100 m in length.
- Switch configuration, including the required LLDP for proper PoE+ operation.
- DHCP server configuration.
- Firmware upload for your Cisco Vision Dynamic Signage Director release.
- Auto-registration settings for the DMP to properly provision its firmware.
- Multicast is enabled on the network
- NTP is operational

When you have completed these deployment tasks, connect a new DMP device to the Cisco Vision Director network.

Startup Sequence Flow for the Digital Media Player

[Table 1 on page 62](#) provides a summary of the tasks and related information to deploy the digital media player. This example is written using a DMP-2K device.

Startup Sequence Flow for the Digital Media Player

Note: The provisioning and registration process uses a random wait time to prevent large number of devices sending requests to the servers at the same time. As a result, the time for each DMP device to finish the startup sequence will be different.

Table 1 DMP Startup Task Sequence



Startup Task	TV Display:
<p>DMP obtains IP address from DHCP server.</p> <p>Note: If you have configured and enabled WiFi for a DMP, then an IP address is also acquired and displayed for the WiFi adapter.</p>	
<p>DMP contacts the Cisco Vision Dynamic Signage Director server.</p>	
<p>Err LED blinks for a short period (normal).</p> <p>Note: If you have configured and enabled WiFi for a DMP, then the WiFi LED will flash and then remain steady. The Eth LED should be off.</p>	
<p>DMP reboots.</p>	<p>Caution: During the initial provision process, or after factory reset, the DMP will reboot multiple times before completing the process. Do not interrupt. This can take several minutes.</p>

Table 1 DMP Startup Task Sequence (continued)

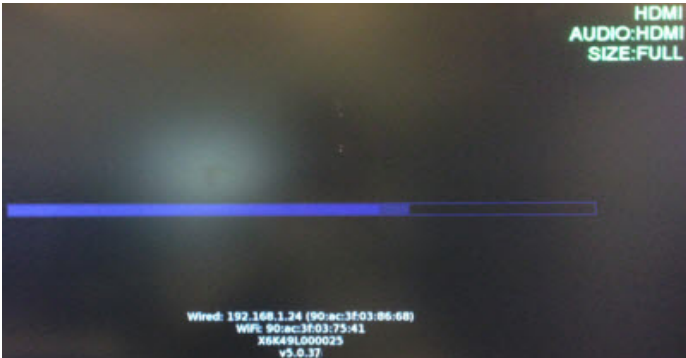

Startup Task	TV Display:
<p>Firmware upgrade message. (As applicable—Only after the DMP has been initially deployed).</p>	<p>The following message appears if firmware upgrade is needed:</p> <p style="text-align: center;">Current system version is out of date. Restart and update!</p> <p>The device reboots to complete the upgrade process.</p> <p>The TV repeats display of the screens for obtaining the IP address from DHCP server and contacting Cisco Vision Dynamic Signage Director server again before bypassing the firmware upgrade step.</p>
<p>Firmware upgrade in progress.</p>	 <p>The image shows a dark screen with a horizontal progress bar in the center, consisting of a blue line with a yellow-to-orange gradient. Below the bar, the text 'SV-4KNA X9K49K00016 v6.0.7' is displayed in white.</p>

Table 1 DMP Startup Task Sequence (continued)

Startup Task	TV Display:
<p>Configuration files from Cisco Vision Dynamic Signage Director server download.</p>	
<p>HTML runtime starts.</p>	
<p>Verify DMP device has registered in Configuration > Devices > Locations & DMPs.</p>	 <p>Note: If Location has not yet been specified, the Type will be DMP.</p>

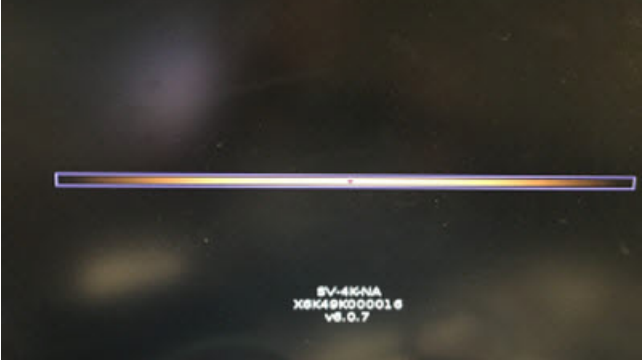
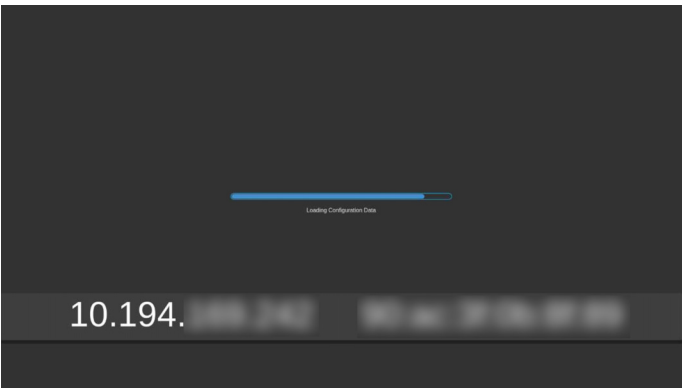
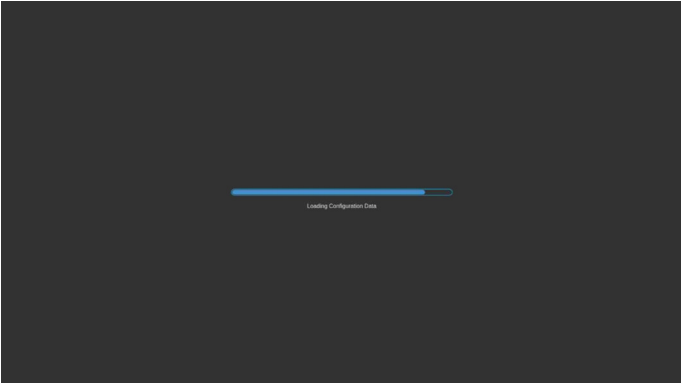

Monitoring and Maintaining the Digital Media Player

Series 2 DMPs: DMP-2K and SV-4K

Series 3 DMPs: CV-HD and CV-UHD

Series 4 DMPs: CV-HD2 and CV-UHD2

This module describes the workflow and tasks to monitor and maintain the working operation of the digital media player. It is intended for Cisco Vision Dynamic Signage Director administrators and installers.

For more information, see also the [Release 6.3: Cisco Vision Dynamic Signage Director Operations Guide](#).

This module includes the following topics:

- [Performing a Regular Reboot of the Digital Media Players, page 65](#)
- [Verifying Digital Media Player Compliance, page 65](#)
- [Clearing the Storage on the Digital Media Player, page 66](#)
- [Clearing Registries on the Digital Media Player by Restoring Factory Defaults, page 68](#)

Performing a Regular Reboot of the Digital Media Players

Perform a regular reboot of the devices to maintain normal operation of the digital media players. We recommend a weekly reboot.

For information about how to configure the Reboot DMP system task, see the [Task Note: Configure Reboot DMPs](#).

Note: The reboot task applies globally to all media player devices. It is not enabled by default.

Verifying Digital Media Player Compliance

Cisco Vision Director allows you to compare values on the DMP device against required values configured in the Cisco Vision Dynamic Signage Director DMP settings.

[Figure 1 on page 66](#) shows how a DMP device should appear when it is fully compliant with the configured Cisco Vision Dynamic Signage Director settings:

- Required Value—Value configured in Cisco Vision Dynamic Signage Director, or automatically set by the system.
- Value on Device—Setting that the DMP device is running.

Figure 1 Normal Compliance for a DMP Device

Name	Required Value	Value on Device
✓ dwsEnabled	yes	yes
✓ init.DHCP	on	on
✓ init.startService_ntpc	yes	yes
✓ init.startService_snmp	yes	yes
✓ ntpc.hostname	1.ntp.esl.cisco.cor	1.ntp.esl.cisco.com
✓ ntpc.interval	3600	3600
✓ ntpc.timezone	PST	PST
msi.sw_vlan	\$svd_ignore	225
✓ use_igmp_v2	false	false
✓ init.version	8.0.72	8.0.72

Table 1 DMP Compliance Property Descriptions

Property Name	Description
dwsEnabled	Enables ability to access the DMPs Diagnostic Web Server. ¹
init.DHCP	Value is always “on.” Static IP addresses are not supported.
init.startService_ntpc	NTP client service on the DMP device. Value is always “yes.”
init.startService_snmp	(Release 4.1 and Later) SNMP agent service on the Series 2 and Series 3 device. Default value is no.
init.version	DMP firmware version.
ntpc.hostname	Name of the NTP server for the DMP. For PTP secondaries, setting the time via NTP is disabled on DMP.
ntpc.interval	Interval (in seconds) after which the PTP leader synchronizes its time with the NTP host.
ntpc.timezone	Timezone for the DMP.
msi.sw_vlan	Switch VLAN reported by LLDP for the DMP. “\$svd_ignore” setting in Dynamic Signage Director means that the value is not used for compliance verification.
use-igmp_v2	This corresponds to the global DMP setting “Force IGMPv2” (under Networking).

1. The global DMP setting “Enable DWS” (under Networking) should match what the DMP reports. It is possible for a DMP to report a value different from the registry key. This can happen when DWS is enabled or disabled via DMP Command.

To verify digital media player compliance:

1. Click **Device Management**.
2. In the **Selected Devices** panel, select all DMPs about which you want an updated status. The lower **Status** pane appears.
3. Click the **Compliance** tab.

Clearing the Storage on the Digital Media Player

The DMP devices have different sizes of local storage:

- The CV-HD2 DMPs have 128 GB of storage with approximately 100 GB available for content.

Clearing the Storage on the Digital Media Player

- The CV-UHD2 DMPs have 128 GB of solid-state storage with approximately 100 GB available for content.
- The SV-4K and Series 3 DMPs have 120 GB of solid-state storage with approximately 100 GB available for content.
- The DMP-2K DMPs have 64 GB of solid-state storage with approximately 53 GB available for content.

If you are running out of storage or need to recover the SSD, clear the storage on the media player.

To find information about available storage:

1. Select a DMP device in the **Device Dashboard** device list.
2. Click the **Settings** tab > **Storage** in the device details area of the dashboard.

Note: The HTML runtime must be running on the digital media player to use this task.

You also can find information about available storage if you view device details from thumbnail view in **Device Management (CCM)**.

To clear the storage on the digital media player:

1. Click **Device Management**.
2. Select the DMP devices that you want to clear.
3. Use the drop-down arrow to select **Reset Storage** (Figure 2 on page 67).

Figure 2 Reset Storage Command

The screenshot shows the Cisco Vision Dynamic Signage Director interface. On the left, a sidebar lists 'All Devices'. A dropdown menu is open over a table of devices, with 'Reset Storage' highlighted. The table has columns for IP Address, MAC Address, Firmware, TV Power, TV Health, and DMP Health. Below the table, there are tabs for 'Basic', 'Display Attributes', 'HDMI Display', 'Network', and 'NTP'. The 'Basic' tab is active, showing a table of properties and values.

IP Address	MAC Address	Firmware	TV Power	TV Health	DMP Health
10.194.170.114	90:ac:3f:0a:22:6c	8.2.33	On	Normal	● ○ ⏻
10.194.171.87	90:ac:3f:15:df:c4	8.2.33	Off	Critical	● ○ ⏻
10.24.123.236	--			Unknown	● ○ ⏻
192.168.1.100	--			Unknown	● ○ ⏻

Property	Value
Firmware version	8.2.33
Model name	CV-UHD2
Switch Model	WS-C2960S-48FPD-L
Switch Port	GI1/0/46

4. Click **Send Command**.

The contents of the SSD storage is removed (including the Cisco Vision Dynamic Signage Director runtime software and script contents) on the devices. The devices will not automatically reboot after this command.

5. Use the drop-down arrow to select **Reboot Device** (Figure 2 on page 67).
6. Click **Send Command**.

The selected devices reboot and re-provision firmware and settings.

Clearing Registries on the Digital Media Player by Restoring Factory Defaults

To clear the registries on the digital media player:

1. Click **Device Management**.
2. Select the devices that you want to clear.
3. Use the drop-down arrow to select **Restore Default Settings** ([Figure 2 on page 67](#)).
4. Click **Send Command**.
5. Any persistent device settings on the DMPs are erased and the box will be in factory default state. The DMP automatically reboots and re-provisions its firmware and settings.



Troubleshooting the Digital Media Player

Series 2 DMPs: DMP-2K and SV-4K

Series 3 DMPs: CV-HD and CV-UHD

Series 4 DMPs: CV-HD2 and CV-UHD2

This module provides some troubleshooting steps by symptoms for DMP hardware, PTP operation, and video display problems. It includes information about the RMA process and the DMP diagnostic URL.

This module includes the following topics:

- [Before You Begin Troubleshooting the DMPs, page 69](#)
- [Troubleshooting PTP Operation for the Digital Media Player, page 70](#)
- [Troubleshooting DMP Hardware Operation, page 71](#)
- [Troubleshooting DMP TV and Video Display Problems, page 73](#)

Before You Begin Troubleshooting the DMPs

Before you begin troubleshooting the DMPs, follow the information in these topics:

- [RMA Process for the DMPs, page 69](#)
- [DMP Diagnostic URL, page 69](#)

RMA Process for the DMPs

The Return Materials Authorization (RMA) process is covered by the Cisco Solution Support Service for Cisco Vision.

Before you open a Cisco Solution Support case for the DMPs:

1. Locate your symptom in the DMP troubleshooting topics and try to isolate the problem by following the suggested troubleshooting steps.
2. If you cannot resolve the problem with any of the recommended troubleshooting steps, open a Cisco Solution Support case to further troubleshoot and coordinate the return process with the vendor.

DMP Diagnostic URL

Some of the troubleshooting steps for the DMPs recommend that you open a browser and navigate directly to the device using the following URL to further diagnose a problem:

`http://dmp-ip-address`

The diagnostic URL requires a password. The password is set in the “**defaultDmpAdminPwd**” registry key in **System Configuration** interface. The default username is “**admin.**”

Reset the password from the default value as a security best practice.

IMPORTANT: If a request to reboot the DMP fails, there is a new fallback password registry available: **defaultDmpAdminPwdBackup**.

To change the DMP password:

1. Click **Configuration > System Configuration > Advanced Registry Settings**.
2. Copy the registry value in **defaultDmpAdminPwd** to **defaultDmpAdminPwdBackup** registry value.
3. Change the value of **defaultDmpAdminPwd** to the new DMP password you want.
4. Click **Save**.
5. Reboot the DMPs.

You can choose to keep or clear the value in **defaultDmpAdminPwdBackup** after the DMPs reboot and update their password.

Note: This password is also used for the Diagnostic Web Server (DWS).

Troubleshooting PTP Operation for the Digital Media Player

This section identifies some of the symptoms related to problems with PTP operation:

- [Symptom: Local PNGs are not synchronized across DMP devices, page 70](#)
- [Symptom: Playlists do not advance to the next content item on the DMP, page 70](#)

Symptom: Local PNGs are not synchronized across DMP devices

Troubleshooting steps:

1. Verify the PTP configuration on your DMP devices:
 - Click **Configuration > System Configuration > Global DMP Settings > Time Source**
2. Verify that the PTP domain and PTP leader candidates property configuration is correct for your network.
3. Open your browser and navigate to one of the devices:
 - http://dmp-ip-address/ptp.html**
4. Enter the username and password.
5. Look for the message “PTP is not enabled.”

This message might mean that the device was not rebooted after changes to the settings.

If the message appears, reboot the DMP device.

Symptom: Playlists do not advance to the next content item on the DMP

If the current PTP leader becomes unreachable (shuts down, or becomes unreachable on the network), the PTP members will be unable to update their clocks and this condition will occur.

Troubleshooting steps:

1. Verify the PTP configuration on your DMP devices:

Click **Configuration > System Configuration > Global DMP Settings > Time Source**

2. Verify that the PTP domain and PTP leader candidates property configuration is correct for your network.
3. Open your browser and navigate to one of the devices:

http://dmp-ip-address/ptp.html

4. Enter the username and password.
5. Identify the PTP leader by finding the unit that has an “offsetFromMaster” value of 0.0 (Figure 1 on page 71).

Figure 1 Identify the PTP Leader

PTP clock status

```

Status from local PTP:
sending: GET CURRENT_DATA_SET
90ac3f.ffff.03864a-0 seq 0 RESPONSE MANAGEMENT CURRENT_DATA_SET
  stepsRemoved 0
  offsetFromMaster 0.0 ←
  meanPathDelay 0.0

Status from remote PTP devices:
sending: GET CURRENT_DATA_SET
90ac3f.ffff.038637-1 seq 0 RESPONSE MANAGEMENT CURRENT_DATA_SET
  stepsRemoved 1
  offsetFromMaster 2997.0
  meanPathDelay 15377.0
    
```

6. Ping the leader PTP device.
7. If the leader is not reachable and you have configured alternate leaders, but they are not reported as leader after waiting for a minute, reboot one of the reachable PTP leader candidates.

Note: Identifying the alternate leader for this step is easier if you are explicitly identifying the IP address of alternate leaders and not using the “*” wildcard to specify possible election of any DMP device on the network.

8. If a device shows that it has not synchronized, reboot the device to force synchronization.

Troubleshooting DMP Hardware Operation

This section identifies some of the symptoms related to problems with the digital media player hardware:

- Symptom: “Please Insert Card” message on SV-4K or DMP-2K startup screen, page 72
- Symptom: Pwr and Eth LEDs are not lit and no signs of activity on the DMP, page 72
- Symptom: DMP Err or Err/Upd LEDs blinking, page 72
- Symptom: DMP rebooting automatically after startup, page 72
- Symptom: DMP lose storage after startup power loss, page 73

Symptom: “Please Insert Card” message on SV-4K or DMP-2K startup screen

Troubleshooting steps:

1. Verify that an IP address is assigned to the device.
2. Verify proper DHCP Option 43 configuration.
3. Verify proper DHCP Option 60 configuration.
4. Verify that the Cisco Vision Dynamic Signage Director server is running and reachable.
5. Contact Cisco Technical Support to do further troubleshooting and proceed with RMA process.

Symptom: Pwr and Eth LEDs are not lit and no signs of activity on the DMP

Troubleshooting steps:

1. Check for any visible damage to the Ethernet port on the DMP device.
If there is not any visible port damage on the DMP:
2. Connect a 12V 5A power supply to the media player to confirm startup and normal operation.
3. Replace the Ethernet cable.
4. Connect the media player to a known-working switch port for another DMP device.
5. Verify the PoE+ settings on the switch.

Note: If you have imported the switch settings to Cisco Vision Dynamic Signage Director, you can view the PoE+ settings. Click **Configuration > System Configuration > Management Dashboard > Power over Ethernet > Default Switch parameters**

Power normally displays “29.5” for the DMP after LLDP negotiation with the switch.

6. If none of these steps locate the problem, contact Cisco Technical Support to proceed with the RMA process.

Symptom: DMP Err or Err/Upd LEDs blinking

Troubleshooting steps:

1. Refer to the LED documentation.
See [LEDs on the Series 2 Media Players, page 34](#), [LEDs on the Series 3 Media Players, page 36](#), and [LEDs on the Series 4 Media Players, page 36](#).
2. Troubleshoot according to the description of the problem.

Symptom: DMP rebooting automatically after startup

Troubleshooting steps:

1. Verify whether multiple devices are doing an auto-reboot.
2. If multiple devices are automatically rebooting at startup:
 - a. Verify that the devices are obtaining an IP address.

- b. If the devices are not getting an IP address (“Unable to get IP address” message on the TV display), verify communication to the DHCP server.
- c. Verify proper DHCP Option 43 configuration.
- d. Verify proper DHCP Option 60 configuration.
- 3. If the SV-4K or DMP-2K stays at the loading screen with the progress bar, verify communication with the Cisco Vision Dynamic Signage Director server.
- 4. (Advanced) Verify that an HTTP request comes in to the /var/log/httpd/access_log (use the System State Report [SSR]).

Look for a message like the following:

```
10.194.169.242 - - [13/Oct/2014:13:10:05 -0700] "GET /StadiumVision/dmp_v4/scripts/boot.brs
HTTP/1.1" 200 89403 "-" "-"
```

Symptom: DMP lose storage after startup power loss

Note: If there is power loss or failure, a tripped circuit, or interrupted AC power source between the wall and the AC power brick, the DMP may lose storage. There may be residual charge from the capacitors in the AC power brick that cause the SSD to temporarily fail while circuitry switches over to PoE.

Troubleshooting steps:

1. Disconnect the LAN cable.
2. Disconnect the molex connector from back of DMP.
3. Plug the molex connector back in.
4. Plug the LAN cable back in.

The SSD is OK upon being rebooted. No storage command is necessary.

Also, storage loss does not happen when you configure “power inline never” on the DMP ports or plug the DMP into a switch that does not offer PoE.

Note: Do not supply power to the network port when using AC power.

Troubleshooting DMP TV and Video Display Problems

This section identifies some of the symptoms related to problems with the DMP displays:

- [Symptom: Black screen on the TV display/no multicast video stream, page 73](#)
- [Symptom: No local control when external volume strategy configured, page 74](#)

Symptom: Black screen on the TV display/no multicast video stream

Troubleshooting steps:

1. Verify if multiple TV displays are showing a black screen for the same multicast video stream.
2. If multiple TV displays are showing a black screen for the same multicast stream:
 - a. Verify the media player LEDs.

- b. If the LEDs are in normal state, verify that the Cisco Vision Dynamic Signage Director server has power and is reachable.
 - c. If all TV displays are the same and/or new model, test with a different, known-working TV display model.
 - d. (Advanced) Test with laptop connected to the same switch port/interface as the device with a problem, and see if the problematic video stream can be displayed using the open source VLC player.
 - e. Test a different multicast video stream.
 - f. Test with local video content. If local video works, troubleshoot video headend and/or other network problems.
 - g. Confirm video output setting on the DMP using a browser to go to: <http://sv4k-ip-address>.
3. If the problem can be isolated to a DMP device:
- a. Verify that the Pwr/Eth LEDs are on.
 - b. Try a different HDMI cable.
 - c. Test a different TV display.
 - d. (Advanced) Test with laptop connected to the same switch port/interface as the DMP with a problem, and see if the problematic video stream can be displayed using the open source VLC player.

Symptom: No local control when external volume strategy configured

Troubleshooting steps:

1. Verify the RS-232 cable is connected.
2. Verify the serial cable type being used against the RS-232 requirements for the TV display (null modem [crossover] or straight through).
3. Verify that the external output strategy works on other TV displays.
4. Verify the RS-232 codes from the manufacturer against the TV display specifications in Cisco Vision Dynamic Signage Director.
5. Verify the default baud rate for the TV.



Appendix A: DMP and TV Controls Commands for the Digital Media Players

Series 2 DMPs: DMP-2K and SV-4K

Series 3 DMPs: CV-HD and CV-UHD

Series 4 DMPs: CV-HD2 and CV-UHD2

This module provides a summary of the **DMP and TV Controls** commands that are supported by the digital media player.

- [Monitoring Commands for the Digital Media Player, page 75](#)
- [DMP Commands for the Digital Media Player, page 76](#)
- [DMP Install Commands for the Digital Media Player, page 76](#)
- [TV Commands for the Digital Media Player, page 76](#)
- [Auto-Registration Commands for the Digital Media Player, page 77](#)

Monitoring Commands for the Digital Media Player

Table 1 Device Monitoring Commands

Command Name	Supported on the DMPs
Get Status	Yes
Ping	Yes

DMP Commands for the Digital Media Player

Table 2 Cisco Vision Director DMP Commands

Command Name	Supported on DMPs
Display IP	Yes
Restart Runtime	Yes
Disable Diagnostic Web Server	Yes
Enable Diagnostic Web Server	Yes
Start Streaming	Yes
Stop Streaming	Yes
Start Web Application	Yes
Stop Web Application	Yes
Send RS232	Yes
Reboot Device	Yes

DMP Install Commands for the Digital Media Player

Table 3 DMP Install Commands

Command Name	Supported on DMPs
Firmware Upload	Yes (only for firmware upload; not to provision firmware)
Restore Default Settings	Yes
Reset Storage	Yes

TV Commands for the Digital Media Player

Table 4 Cisco Vision Director TV Commands

Command Name	Supported on DMPs
TV On	Yes
TV Off	Yes
Set Display Input	Yes
Set Display Banner	Yes
Set Closed Caption	Yes
Set Volume	Yes
Set Video Channel	Yes
Show Diagnostics	Yes
Hide Diagnostics	Yes
Display PIN	Yes
Show Channel Guide	Yes
Hide Channel Guide	Yes

Auto-Registration Commands for the Digital Media Player

Table 5 Auto-Registration Commands

Command Name	Supported on DMPs
Change DMP State	Yes
Provision DMP	No

Auto-Registration Commands for the Digital Media Player



Appendix B: Display Parameters for the Digital Media Players

Series 2 DMPs: DMP-2K and SV-4K

Series 3 DMPs: CV-HD and CV-UHD

Series 4 DMPs: CV-HD2 and CV-UHD2

This module provides a summary of the display parameters that are supported by the digital media player for communication with TV displays.

Display Parameters for HDMI CEC TV Control on DMPs

Table 1 on page 79 shows the display parameters used for HDMI/CEC TV control.

Note: The default values for the HDMI CEC display parameters are set in the HDMI/CEC Standard display specification.

Table 1 Display Parameters for HDMI CEC TV Control

Display Parameter	Default Value ¹	Description
dmp.hdmiStreamingDelay	5000	For HDMI Streaming operations issued through local control API. For HDMI Streaming operations initiated via IR Remote, this parameter prevents too frequent commands from crashing the DMP.
dmp.monitorAPIDelay	120000 ms (2 minutes)	Frequency of power query command sent by Dynamic Signage Director over HDMI CEC to the TV. (This command is also supported when using TV control with RS-232.)
dmp.monitorPower	true	Enables Dynamic Signage Director to run a power query to the TV using the Get Status command from Device Management. (This command is also supported when using TV control with RS-232.)
dmp.powerQueryByCEC	true	(New in Release 5.0) Enables powerQuery to get TV Power status using HDMI/CEC instead of RS-232. Note: This command is not supported by all TV models so it is separately configurable.
dmp.SupportsTouchScreen	true	Enables Dynamic Signage Director to support plugged-in devices configured to support touchscreen capability.
dmp.TVControlbyCEC	true	(New in Release 5.0) Enables TV control using HDMI/CEC instead of RS-232.

1. The default values are set in the HDMI/CEC Standard display specification.

Display Parameter for Portrait Mode Content Renditions on DMPs

Note: Scaling of content across multiple display screens in portrait mode is only supported for multicast streaming video and static images.

Table 2 DMP Display Parameters for Portrait Mode

Display Parameter	Accepted Values	Default Value	Description
dmp.portrait	true/false	Not specified	Enables auto-rotation of content to vertical orientation on a TV display.
dmp.portrait.clockwise	true/false	Not specified	Enables content rotation of 90 degrees (portrait) or -90 degrees (270 degrees).

Display Parameters for RS-232 TV Control on DMPs

Table 3 on page 81 shows a summary of the serial commands for the DMPs and their default values.

Note: Different TV display models might support only certain RS-232 display parameters.

Table 3 DMP Display Parameters for RS-232 TV Control¹

Display Parameter	Value
dmp.displayAVInputQuery	rs232.tx_hex=6B622030312046460D
dmp.displayPwrOnResponse	61203031204f4b303178
dmp.displayPwrQuery	rs232.tx_hex=6B612030312046460D
dmp.hdmiStreamingDelay	5000
dmp.Input1response	62203031204F4B303878
dmp.Input2response	62203031204F4B303278
dmp.Input3response	62203031204F4B303478
dmp.Input4response	62203031204F4B303078
dmp.monitorAPIDelay	120000
dmp.monitorAVInput	true
dmp.monitorMute	true
dmp.monitorPower	true
dmp.monitorVolume	true
dmp.muteOnResponse	65203031204F4B303078
dmp.muteQuery	rs232.tx_6B652030312046460D
dmp.powerQueryByCEC	false
dmp.RelativeVolumeSteps	Not Configured
dmp.SerialDelay	250
dmp.SupportsTouchScreen	true
dmp.TVControlByCEC	true
dmp.volumeQuery	rs232.tx_6B662030312046460D
dmp.volumeResponseFormat	66203031204F4B5F5F78
Enable	Not Configured
Input1	rs232.tx_6B622030312030390D
Input1Name	HDMI
Input2	rs232.tx_6B622030312030320D
Input2Name	Composite
Input3	rs232.tx_6B622030312030340D
Input3Name	Component
Input4	rs232.tx_6B622030312030300D
Input4Name	TV
Mute	rs232.tx_hew=6B652030312030300D
MuteToggle	Not Configured
New serial command	Not Configured

Display Parameters for RS-232 TV Control on DMPs

Table 3 DMP Display Parameters for RS-232 TV Control¹ (continued)

Display Parameter	Value
Off	rs232-tx_hex=6B612030312030300D
On	rs232-tx_hex=6B612030312030310D
UnMute	rs232-tx_hex=6B652030312030310D
Volume1	rs232-tx_hex=6B662030312030350D
Volume10	rs232-tx_hex=6B662030312035300D
Volume11	rs232-tx_hex=6B662030312035350D
Volume12	rs232-tx_hex=6B662030312036300D
Volume2	rs232-tx_hex=6B662030312031300D
Volume3	rs232-tx_hex=6B662030312031350D
Volume4	rs232-tx_hex=6B662030312032300D
Volume5	rs232-tx_hex=6B662030312032350D
Volume6	rs232-tx_hex=6B662030312033300D
Volume7	rs232-tx_hex=6B662030312033350D
Volume8	rs232-tx_hex=6B662030312034300D
Volume9	rs232-tx_hex=6B662030312034350D
VolumeCount	12

1. The commands in this table are supported by the LG 19LH20 TV display.

For more information about configuring display parameters for RS-232 TV control, see “Working with TV Displays in Cisco Vision Director” topic of the [Release 6.3: Cisco Vision Dynamic Signage Director Operations Guide](#).



Appendix C: Configuring an IOS DHCP Server to Support the Digital Media Players

Series 2 DMPs: DMP-2K and SV-4K

Series 3 DMPs: CV-HD and CV-UHD

Series 4 DMPs: CV-HD2 and CV-UHD2

Note: An IOS Switch is not recommended as a production DHCP server for a venue. This example is provided to allow for simple DHCP support for DMPs primarily used for testing and in a lab.

In this example, a Cisco IOS DHCP server is being used. Only a single pairing of options 60 and 43 can be used within a single scope (two different IP scopes are required if there is a need to support both the SV-4K and the CV-UHD media players, for example).

Note: If a Cisco IOS DHCP Server is used for IP address allocation for DMPs in a production network, we strongly recommend using database agents to maintain the DMP address bindings in case the switch is rebooted. See [IP Addressing: DHCP Configuration Guide, Cisco IOS XE Release 3SE \(Catalyst 3850 Switches\)](#) for further IOS DHCP Server configuration.

SV-4K DHCP Scope Example

This is an example using the specific strings that apply to an SV-4K media player.

```
! DHCP Database Agent CLI example
ip dhcp database ftp://user:password@172.16.4.253/router-dhcp write-delay 120
!
ip dhcp pool SV-4K
network 10.10.1.0 255.255.255.0
default-router 10.10.1.1
option 60 ascii Cisco SV-4K-NA
option 43 hex
5540.6874.7470.3A2F.2F31.302E.3139.342E.3137.352E.3132.323A.3830.3830.2F53.7461.6469.756D.5669.7369.6F6
E.2F64.6D70.5F76.342F.7363.7269.7074.732F.626F.6F74.2E62.7273
```

Note: The periods in the option 43 string are automatically created by the IOS and are not typed when creating the ASCII string. An example of the raw ASCII string value as typed can be found below.

Creating Option 60

Note: For DHCP Servers that require Option 60, type the “option 60” line as shown in [SV-4K DHCP Scope Example, page 83](#).

Possible variations are:

SV-4K DHCP Scope Example

- Some Cisco IOS software versions may require the text enclosed in quotes “Cisco SV-4K-ROW”.
 - Note:** If the Cisco IOS software does not accept a leading quote in the string, then quotations are not needed.
- DHCP Option 60 Vendor Class Identifier string for DMPs:
 - CV-HD2 global string: “Cisco CV-HD2”
 - CV-UHD2: “Cisco CV-UHD2”
 - CV-HD global string: “Cisco CV-HD”
 - CV-UHD global string: “Cisco CV-UHD”
 - CV-UHD with WiFi = “Cisco CV-UHD WiFi”
 - DMP-2K string for new, factory-shipped devices: “Cisco DMP-2K”
 - SV-4K string for North America: “Cisco SV-4K-NA”
 - SV-4K string for all other regions: “Cisco SV-4K-ROW”

Creating Option 43

Option 43 is a vendor-specific option. For the digital media player, it needs to point to a specific URL to execute auto-registration, auto-provisioning, and to receive initial firmware and subsequent upgrades, etc. That URL is:

http://x.x.x.x:8080/CiscoVision/dmp_v4/scripts/boot.brs

where x.x.x.x represents the IPv4 address of the Cisco Vision Dynamic Signage Director server.

Note: Different devices require option 43 information be presented in different formats.

The digital media player require type-length-value (TLV) format for the data string. Specifically, the TLV format is constructed in the following manner:

- The string is built using hex values.
- The string begins with a two-character hex representation of the option 43 Type (an option 43 sub-option).
- The second two-character hex representation is the length of the information string, expressed in the number of ASCII characters of the string.
- Following the length value, the ascii string is typed out by using the two-character hex representation of each character in the string.
- For all the DMPs, the type designation is type 85 (decimal), expressed as type 55 (hex).

Option 43 Example

For the following URL string:

http://10.194.175.122:8080/CiscoVision/dmp_v4/scripts/boot.brs

The option 43 string would be as follows (except all on one line, without carriage returns) in the following format:

option 43 hex
 5540.6874.7470.3A2F.2F31.302E.3139.342E.3137.352E.3132.323A.3830.3830.2F53.7461.6469.756D.5669.7369.6F6
 E.2F64.6D70.5F76.342F.7363.7269.7074.732F.626F.6F74.2E62.7273

Note: There is a space here between ‘hex’ and the remainder of the string

SV-4K DHCP Scope Example

Using the sample URL above and [Table 1 on page 85](#), the first characters of the hex value are translated in the following way:

5540.6874.7470.3A2F.2F31.302E.3139.342E.3137.352E.3132.323A.3830.3830.2F53.7461.6469.756D.5669.7369.6F6E.2F64.6D70.5F76.342F.7363.7269.7074.732F.626F.6F74.2E62.7273

- 55 - Type code in hex
- 40 - Length of the characters to the right of the length value, expressed by counting the number of two-character ascii characters represented (form the chart below). The numbers if characters in the example above is 64 (Decimal 64 = 40 hex).
- And the first few characters, one at a time, would be:

```
68 74 74 70 3A 2F 2F
h t t p : / /
```

The IP address is then represented the same way:

```
31 30 2E 31 39 34 2E 31 37 35 2E 31 32 32
1 0 . 1 9 4 . 1 7 5 . 1 2 2
```

The remainder of the string is the text of the remainder of the URL:

:8080/CiscoVision/dmp_v4/scripts/boot.brs

A.3830.3830.2F53.7461.6469.756D.5669.7369.6F6E.2F64.6D70.5F76.342F.7363.7269.7074.732F.626F.6F74.2E62.7273

Note: The Cisco Vision Dynamic Signage Director server is case sensitive, and the correct letter case must be represented in the ASCII text strings.

TIPS

- To make creating the string easier, start the string with 55 and copy the remainder of the ASCII string past the IP address, as these values never change.
- The example string had a length value of 40 (64 represented as a hex value).
- In this value, do not represent 64 as the hex character values of 6 and 4: instead, take the decimal value of 64 and convert to its equivalent hex (base 16) value (64 was converted to 3E in the example).
- Decimal-to-hex converters are easily found on the Internet, and most computer calculators have a decimal-to-hex function available, possibly under an advanced feature.

The example IP address was 14 characters long which leaves the remainder of the hex string to be 50 characters long. Add the number of ASCII characters in your IP address (including the dots!) to the known 50 characters and create your string length value to replace the 40.

This technical information can be used to program other 3rd-party DHCP servers.

Table 1 ASCII Character Lookup Table

Decimal	Hex	Symbol	Description
32	20		Space
33	21	!	Exclamation mark
34	22	"	Double quotes (or speech marks)

SV-4K DHCP Scope Example

Table 1 ASCII Character Lookup Table (continued)

Decimal	Hex	Symbol	Description
35	23	#	Number
36	24	\$	Dollar
37	25	%	Procenttecken (per cent sign)
38	26	&	Ampersand
39	27	'	Single quote
40	28	(Open parenthesis (or open bracket)
41	29)	Close parenthesis (or close bracket)
42	2A	*	Asterisk
43	2B	+	Plus
44	2C	,	Comma
45	2D	-	Hyphen
46	2E	.	Period, dot or full stop
47	2F	/	Slash or divide
48	30	0	Zero
49	31	1	One
50	32	2	Two
51	33	3	Three
52	34	4	Four
53	35	5	Five
54	36	6	Six
55	37	7	Seven
56	38	8	Eight
57	39	9	Nine
58	3A	:	Colon
59	3B	;	Semicolon
60	3C	<	Less than (or open angled bracket)
61	3D	=	Equals
62	3E	>	Greater than (or close angled bracket)
63	3F	?	Question mark
64	40	@	At symbol
65	41	A	Uppercase A
66	42	B	Uppercase B
67	43	C	Uppercase C
68	44	D	Uppercase D
69	45	E	Uppercase E
70	46	F	Uppercase F

SV-4K DHCP Scope Example

Table 1 ASCII Character Lookup Table (continued)

Decimal	Hex	Symbol	Description
71	47	G	Uppercase G
72	48	H	Uppercase H
73	49	I	Uppercase I
74	4A	J	Uppercase J
75	4B	K	Uppercase K
76	4C	L	Uppercase L
77	4D	M	Uppercase M
78	4E	N	Uppercase N
79	4F	O	Uppercase O
80	50	P	Uppercase P
81	51	Q	Uppercase Q
82	52	R	Uppercase R
83	53	S	Uppercase S
84	54	T	Uppercase T
85	55	U	Uppercase U
86	56	V	Uppercase V
87	57	W	Uppercase W
88	58	X	Uppercase X
89	59	Y	Uppercase Y
90	5A	Z	Uppercase Z
91	5B	[Opening bracket
92	5C	\	Backslash
93	5D]	Closing bracket
94	5E	^	Caret - circumflex
95	5F	_	Underscore
96	60	`	Grave accent
97	61	a	Lowercase a
98	62	b	Lowercase b
99	63	c	Lowercase c
100	64	d	Lowercase d
101	65	e	Lowercase e
102	66	f	Lowercase f
103	67	g	Lowercase g
104	68	h	Lowercase h
105	69	i	Lowercase i

SV-4K DHCP Scope Example

Table 1 ASCII Character Lookup Table (continued)

Decimal	Hex	Symbol	Description
106	6A	j	Lowercase j
107	6B	k	Lowercase k
108	6C	l	Lowercase l
109	6D	m	Lowercase m
110	6E	n	Lowercase n
111	6F	o	Lowercase o
112	70	p	Lowercase p
113	71	q	Lowercase q
114	72	r	Lowercase r
115	73	s	Lowercase s
116	74	t	Lowercase t
117	75	u	Lowercase u
118	76	v	Lowercase v
119	77	w	Lowercase w
120	78	x	Lowercase x
121	79	y	Lowercase y
122	7A	z	Lowercase z
123	7B	{	Opening brace
124	7C		Vertical bar
125	7D	}	Closing brace
126	7E	~	Equivalency sign - tilde
127	7F		Delete