

Cisco Digital Media Encoder 1000 User Guide

October 2007

THE SPECIFICATIONS AND INFORMATION REGARDING THE PRODUCTS IN THIS MANUAL ARE SUBJECT TO CHANGE WITHOUT NOTICE. ALL STATEMENTS, INFORMATION, AND RECOMMENDATIONS IN THIS MANUAL ARE BELIEVED TO BE ACCURATE BUT ARE PRESENTED WITHOUT WARRANTY OF ANY KIND, EXPRESS OR IMPLIED. USERS MUST TAKE FULL RESPONSIBILITY FOR THEIR APPLICATION OF ANY PRODUCTS.

THE SOFTWARE LICENSE AND LIMITED WARRANTY FOR THE ACCOMPANYING PRODUCT ARE SET FORTH IN THE INFORMATION PACKET THAT SHIPPED WITH THE PRODUCT AND ARE INCORPORATED HEREIN BY THIS REFERENCE. IF YOU ARE UNABLE TO LOCATE THE SOFTWARE LICENSE OR LIMITED WARRANTY, CONTACT YOUR CISCO REPRESENTATIVE FOR A COPY.

The Cisco implementation of TCP header compression is an adaptation of a program developed by the University of California, Berkeley (UCB) as part of UCB's public domain version of the UNIX operating system. All rights reserved. Copyright © 1981, Regents of the University of California.

NOTWITHSTANDING ANY OTHER WARRANTY HEREIN, ALL DOCUMENT FILES AND SOFTWARE OF THESE SUPPLIERS ARE PROVIDED "AS IS" WITH ALL FAULTS. CISCO AND THE ABOVE-NAMED SUPPLIERS DISCLAIM ALL WARRANTIES, EXPRESSED OR IMPLIED, INCLUDING, WITHOUT LIMITATION, THOSE OF MERCHANTABILITY, FITNESS FOR A PARTICULAR PURPOSE AND NONINFRINGEMENT OR ARISING FROM A COURSE OF DEALING, USAGE, OR TRADE PRACTICE.

IN NO EVENT SHALL CISCO OR ITS SUPPLIERS BE LIABLE FOR ANY INDIRECT, SPECIAL, CONSEQUENTIAL, OR INCIDENTAL DAMAGES, INCLUDING, WITHOUT LIMITATION, LOST PROFITS OR LOSS OR DAMAGE TO DATA ARISING OUT OF THE USE OR INABILITY TO USE THIS MANUAL, EVEN IF CISCO OR ITS SUPPLIERS HAVE BEEN ADVISED OF THE POSSIBILITY OF SUCH DAMAGES.

Any Internet Protocol (IP) addresses used in this document are not intended to be actual addresses. Any examples, command display output, and figures included in the document are shown for illustrative purposes only. Any use of actual IP addresses in illustrative content is unintentional and coincidental.

Cisco Digital Encoder User Guide

© 2007 Cisco Systems, Inc. All rights reserved.

TABLE OF CONTENTS

FOREWORD	1
PREFACE	2
OVERVIEW.....	2
DOCUMENT ORGANIZATION.....	2
DOCUMENT CONVENTIONS.....	2
OBTAINING DOCUMENTATION.....	3
<i>Cisco.com</i>	3
<i>Product Documentation DVD</i>	3
<i>Ordering Documentation</i>	3
DOCUMENTATION FEEDBACK.....	4
CISCO PRODUCT SECURITY OVERVIEW.....	4
<i>Reporting Security Problems in Cisco Products</i>	4
PACKAGE CONTENTS.....	5
SAFETY WARNINGS.....	5
INSTALLATION.....	6
CONNECTING THE CISCO DIGITAL MEDIA 1000 ENCODER	7
<i>Cisco Digital Media 1000 Rear Panel Diagram</i>	7
<i>The Cisco Digital Media Encoder 1000 Front Panel Diagram</i>	11
CONFIGURING THE CISCO DIGITAL MEDIA 1000 ENCODER.....	13
<i>Initial Start Setup</i>	13
<i>Configuring Cisco Digital Media 1000 to Connect to an IP Network</i>	15
<i>Changing the Cisco Digital Media 1000 Network Settings</i>	15
WHAT IS STREAMING MEDIA?	18
STREAMING INFRASTRUCTURE.....	18
GUIDE TO STREAMING AUDIO AND VIDEO TYPES.....	19
TUTORIAL: GETTING TO KNOW YOUR CISCO DIGITAL MEDIA 1000	20
BASIC OPERATION: USING THE CISCO DIGITAL MEDIA 1000 FRONT PANEL.....	21
<i>Startup</i>	21
<i>Shutdown</i>	21
<i>Alternate Shutdown Method</i>	21
<i>Starting an Encoding Session</i>	22
<i>Checking CPU Usage</i>	24
<i>Stopping an Encoding Session</i>	24
<i>Connecting an external storage device</i>	25
<i>Exporting Captured Video Files</i>	25
<i>The Unmount Button</i>	26
ADVANCED OPERATION: USING THE NIAGARA SCX WEB INTERFACE.....	27
<i>Accessing the Web Interface</i>	27
<i>Starting an Encoding Session</i>	28
<i>Stopping an Encoding Session</i>	30
<i>Viewing the Encoder Activity Log</i>	31
<i>Configuring the EZStream Buttons</i>	32
ENCODER PRESET (A, B, AND C).....	35
<i>Select Encoder</i>	35
<i>View All Encoders</i>	36
<i>Edit Preset Encoder Profile</i>	36
<i>Editing an Encoder Profile</i>	42

<i>Deleting an Encoder Profile</i>	64
MY ENCODER	66
<i>Computer Name</i>	66
<i>Cisco Digital Media 1000 Properties</i>	67
CISCO DIGITAL MEDIA 1000 ALERTS	69
<i>Email Alert</i>	69
<i>Alarm Light</i>	69
<i>Edit Alert Settings</i>	69
VIEW ALERTS	70
NETWORK PROPERTIES	70
<i>Network Card(s)</i>	72
<i>Advanced Settings (Network)</i>	72
SYSTEM CONFIGURATION SETTINGS	73
<i>Restore Cisco Digital Media 1000 Factory Defaults</i>	73
<i>Email Settings</i>	74
<i>Idle Screen Information</i>	75
<i>Default Directory Setting</i>	76
<i>High Temperature Alert</i>	76
EASE MENU (LCD DISPLAY)	77
ENCODE MENU	77
<i>Encode Start</i>	77
<i>Encode Stop</i>	77
<i>Encode Status</i>	78
ACCESS HEALTH MENU	78
<i>CPU Status</i>	78
<i>Memory Available</i>	78
<i>Temperature Status</i>	78
SETUP SYSTEM MENU.....	78
<i>Network Link Status</i>	78
<i>Network MAC Address</i>	79
<i>View Network Settings</i>	79
<i>Enable DHCP</i>	80
<i>Set Static IP Addresses</i>	80
<i>Set Gateway Address</i>	81
<i>Set Date & Time</i>	82
<i>Setting Temperature Alarm</i>	83
<i>Factory Restore</i>	83
EXPORT FILES MENU	85
<i>Export to USB Drive</i>	85
SHUTDOWN ENCODER.....	85
NIAGARA SCX WEB INTERFACE.....	86
LOG IN	86
HOME PAGE	87
<i>Menu Bar</i>	87
<i>Home</i>	87
<i>Encoders</i>	88
<i>Configuration</i>	88
<i>Status</i>	89
<i>Log Out</i>	89
ALL ENCODERS.....	89
<i>Start Encoder</i>	90
<i>Stop Encoder</i>	91
<i>Edit Encoder</i>	92

<i>Digital Rights Management (DRM) for Windows Media</i>	114
<i>Delete an Existing Encoder</i>	119
<i>Create an Encoder</i>	120
ENCODER PRESET (A, B, & C).....	121
<i>Select Encoder</i>	121
<i>View All Encoders</i>	122
<i>Edit Preset Encoder Profile</i>	122
MY GOSTREAM.....	123
<i>Computer Name</i>	123
<i>Cisco Digital Media 1000 Properties</i>	124
CISCO DIGITAL MEDIA 1000 ALERTS.....	125
<i>Email Alert</i>	125
<i>Alarm Light</i>	126
<i>Edit Alert Settings</i>	126
NETWORK PROPERTIES.....	127
<i>Network Card(s)</i>	128
<i>Advanced Settings (Network)</i>	128
SYSTEM CONFIGURATION SETTINGS.....	129
<i>Restore Encoder Factory Defaults</i>	130
<i>Email Settings</i>	130
<i>Idle Screen Information</i>	131
<i>Default Directory Setting</i>	132
<i>High Temperature Alert</i>	132
VIEW ACTIVITY LOG.....	132
VIEW ALERTS.....	133
THE HELP, OR “I” BUTTON, THE NIAGARA SCX WEB INTERFACE, AND ALERT SETTINGS.....	133

FOREWORD

Congratulations on the purchase of your Niagara[®] Cisco Digital Media 1000 Streaming Media Encoder! You are the fortunate owner of a state-of-the-art streaming media system. Now you can capture and stream your audio and video content over the Internet or any local or wide area IP network. All you need is your audio and video source (such as a camera or deck) a streaming media server or hosting provider, and an IP connection to your viewing audience.

For a complete overview on streaming audio and video over an IP network, go to the section entitled *Introduction* and read the *Streaming Infrastructure section*. This will explain how streaming media works.

Niagara Cisco Digital Media 1000 is an easy-to-use streaming device. You simply connect your audio and video source to Cisco Digital Media 1000, select your target playback device, enter your streaming server information, and press the *Stream button*. You're streaming live!

Niagara Cisco Digital Media 1000 can be configured and used straight out of the box for most streaming uses. For more advanced settings or controlling your Cisco Digital Media 1000 from another networked computer, you will use Niagara SCX Web Interface.

The front panel of your Cisco Digital Media 1000 streaming media encoder can be customized using the Cisco Digital Media 1000 Configuration Web browser interface. This configuration tool also provides the ability to set many other system parameters for your Cisco Digital Media 1000 device.

We hope you enjoy your Niagara Cisco Digital Media 1000 streaming media encoder!



Warning

Read the installation instructions before connecting the system to the power source.



Warning

Only trained and qualified personnel should be allowed to install, replace, or service this equipment.

PREFACE

Revised: October 2007.

Overview

The Cisco Digital Media Encoder 1000 is an easy-to-use streaming device. You simply connect your audio and video source to encoder, select your target playback device, enter your streaming server information, and press the ***Stream*** button. You're streaming live!

The encoder can be configured and used straight out of the box for most streaming uses. For more advanced settings or controlling your encoder from another networked computer, you will use Niagara SCX Web Interface.

Document Organization

This publication is written for the people who will be responsible for setup and advanced operation of this encoder. They should be familiar with streaming media formats in general and the encoder format standards of the organization in which this encoder will be used.

Document Conventions

This publication uses the following conventions to convey instructions and information.

Convention	Description
boldface font	Commands and keywords.
italic font	Variables for which you supply values.
[]	Keywords or arguments that appear within square brackets are optional.
[x y z]	A choice of required keywords appears in braces separated by vertical bars. You must select one.
< >	Nonprinting characters, for example passwords, appear in angle brackets in contexts where italic font is not available.
[]	Default responses to system prompts appear in square brackets.

NOTE: This means *reader take note*. Notes contain helpful suggestions or references to additional information and material.

Caution: This means *reader be careful*. In this situation, you might do something that could result in equipment damage or loss of data.

Warning: This means danger. You are in a situation that could cause bodily injury. Before you work on any equipment, be aware of the hazards involved with electrical circuitry and be familiar with standard practices for preventing accidents.

Obtaining Documentation

Cisco documentation and additional literature are available on Cisco.com. Cisco also provides several ways to obtain technical assistance and other technical resources. These sections explain how to obtain technical information from Cisco Systems.

Cisco.com

You can access the most current Cisco documentation at this URL:

<http://www.cisco.com/techsupport>

You can access the Cisco website at this URL:

<http://www.cisco.com>

You can access international Cisco website at this URL:

http://www.cisco.com/public/countries_languages.shtml

Product Documentation DVD

The Product Documentation DVD is a comprehensive library of technical product documentation on a portable medium. The DVD enables you to access multiple versions of installation, configuration, and command guides for Cisco hardware and software products.

The Product Documentation DVD is available as a single unit or as subscription. Registered Cisco.com users (Cisco direct customers) can order a Product Documentation DVD (product number DOC-DOCDVD= or DOC-DOCDVD=SUB) from Cisco Marketplace at this URL:

<http://www.cisco.com/go/marketplace/>

Ordering Documentation

Registered Cisco.com users may order Cisco documentation at the Product Documentation Store in the Cisco Marketplace at this URL:

<http://www.cisco.com/go/marketplace/>

Non-registered Cisco.com users can order technical documentation from 8:00 a.m. to 5:00 p.m. (0800 to 1700) PDT by calling 1 866 463-3487 in the United States and Canada, or elsewhere by calling 011 408 519-5055. You can also order documentation by e-mail at tech-doc-store-mkpl@external.cisco.com or by fax at 1 408 519 5001 in the United States and Canada, or elsewhere at 011 408 519-5001.

Documentation Feedback

You can rate and provide feedback about Cisco technical documents by completing the online feedback form that appears with the technical documents on Cisco.com. You can submit comments about Cisco documentation by using the response card (if present) behind the front cover of your document or by writing to the following address:

Cisco Systems
Attn: Customer Document Ordering
170 West Tasman Drive
San Jose, CA 95134-9883

We appreciate your comments.

Cisco Product Security Overview

Cisco provides a free online Security Vulnerability Policy portal at this URL:
http://www.cisco.com/en/US/products/products_security_vulnerability_policy.html

From this site, you will find information about how to:

- Report security vulnerabilities in Cisco products.
- Obtain assistance with security incidents that involve Cisco products.
- Register to receive security information from Cisco.

A current list of security advisories, security notices, and security responses for Cisco products is available at this URL:

<http://www.cisco.com/go/psirt>

To see security advisories, security notices, and security responses as they are updated in real time, you can subscribe to the Product Security Incident Response Team Really Simple Syndication (PSIRT RSS) feed. Information about how to subscribe to the PSIRT RSS feed is found at this URL:
http://www.cisco.com/en/US/products/products_psirt_rss_feed.html

Reporting Security Problems in Cisco Products

Cisco is committed to delivering secure products. We test our products internally before we release them, and we strive to correct all vulnerabilities quickly. If you think that you have identified a vulnerability in a Cisco product, contact PSIRT:

- For Emergencies only – security-alert@cisco.com

An emergency is either a condition in which a system is under active attack or a condition for which a severe and urgent security vulnerability should be reported. All other conditions are considered non-emergencies.

- For Non-emergencies-psirt@cisco.com

In an emergency, you can also reach PSIRT by telephone:

1 877 228-7302
1 408 525-6532

Package Contents

Completely unpack all of the contents from the box and inspect each item for damage and ensure that you have all of the components listed below:

- Cisco Digital Media Encoder 1000
- Power Cable
- BNC-to-RCA Converter, Male-to-Female (1)
- *Cisco Digital Media Encoder 1000 User Guide*
- *Cisco Digital Media Encoder 1000 Quick Start Guide*

If any of these components are missing or damaged, do not continue with the installation. Contact the Cisco reseller from which you purchased your encoder system for assistance in obtaining any missing parts or for parts replacement.

The encoder's serial number is located on the bottom of the chassis.

Safety Warnings

Before installing the Cisco Digital Media Encoder 1000™, read and comply with the following safety warnings to ensure that you do not damage the equipment or cause personal injury.

WARNING: Installation of the equipment must comply with local and national electrical codes.

WARNING: Read the installation instructions before connecting the system to the power source.

WARNING: Only trained and qualified personnel should be allowed to install, replace, or service this equipment.

WARNING: This product requires short-circuit (overcurrent) protection, to be provided as part of the building installation. Install only in accordance with national and local wiring regulations.

WARNING: The power supply must be placed indoors.

WARNING: The plug-socket combination must be accessible at all times, because it serves as the main disconnecting device.

WARNING: Do not work on the system or connect or disconnect cables during periods of lightning activity.

WARNING: To avoid electric shock, do not connect safety extra-low voltage (SELV) circuits to telephone-network voltage (TNV) circuits. LAN ports contain SELV circuits, and WAN ports contain TNV circuits. Some LAN and WAN ports both use RJ-45 connectors. Use caution when connecting cables.

INSTALLATION

This section will guide you through the physical connection and setup of your Cisco Digital Media Encoder 1000 system. There are two parts to the complete installation of the encoder, as follows:

1. Connection of the encoder
2. Configuration of the encoder

Most of the basic operations you will routinely use are performed from the front panel of the encoder.

Front Panel

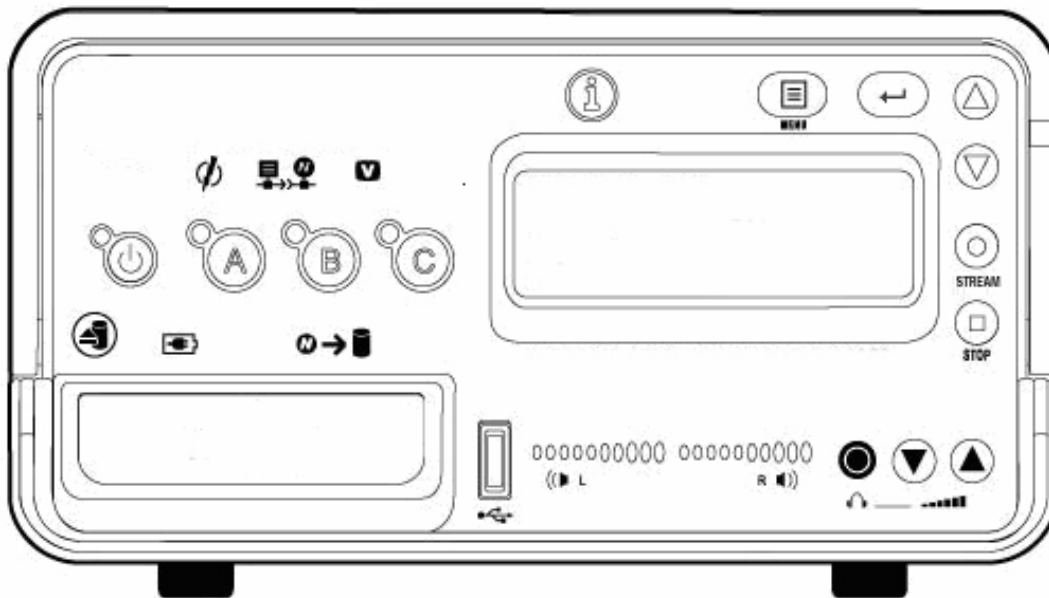

There are advanced setup and operations you may wish to access and to do so you will need to access the *SCX Web Interface* from a computer that resides on the same network as the encoder.

Although these advanced operations are not required for most streaming applications, you may want to customize your encoding settings and assign specific encoding profiles to the *EZStream[®] ABC buttons* on the front panel. The *SCX Web Interface* provides the ability to remote control your Encoder from a computer that could be rooms or continents away from the system provided that both your Encoder and the computer have Internet access to communicate with each other.

First we need to connect the encoder; see the following section for connection information.

CONNECTING THE CISCO DIGITAL MEDIA 1000 ENCODER

Although it has many features and capabilities, the Encoder at its most basic function takes analog audio and video input and processes the signals and then encodes them into digital IP video formats. Then the encoder delivers the IP audio and video content to a storage device or streams it over an IP network.

There are four requirements for setting up the encoder for streaming or capturing video, as follows:

- AC power source (100-240v)
- Audio/Video source (camera, video player, or other A/V output device)
- IP network and/or Internet connection
- A streaming media server for streaming your content to many viewers

Attach the block end of your power cable to the power input located on the upper corner on the rear panel of the encoder.

Plug the other end into a wall outlet or surge protection enabled power strip that is connected to wall outlet or other common power source.

Cisco Digital Media 1000 Rear Panel Diagram



The diagram and table below illustrate all of the connectors and other components of the Encoder rear panel.

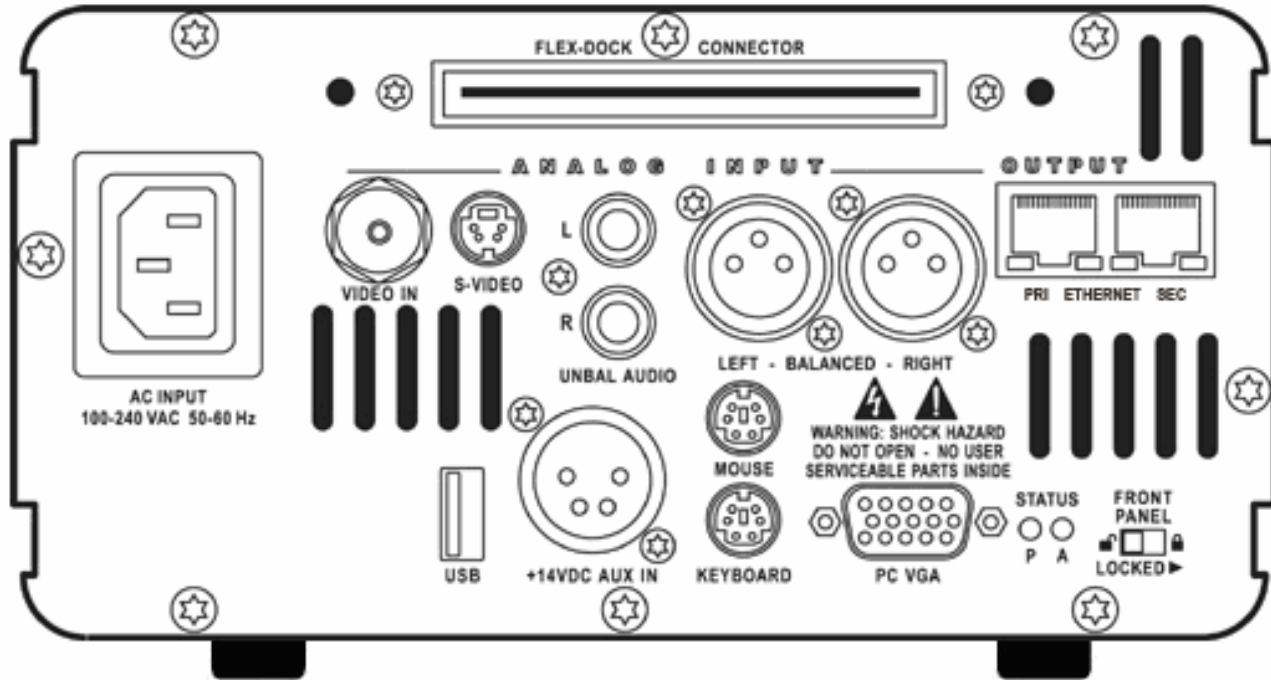



Rear Panel



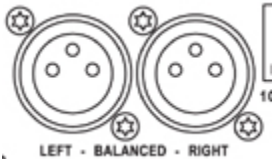
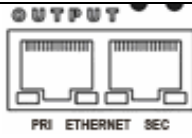
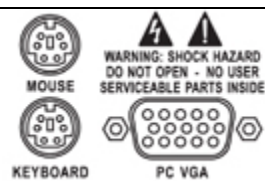

The diagram above shows the rear panel of the encoder. The Analog Input section of the rear panel is used to connect your audio and video source to the encoder.

Using the reference chart and images below, you can connect the appropriate device and power to the Encoder.

Power Connections	
 <p>AC INPUT 100-240 VAC 50-60 Hz</p>	<p>AC Power connector for 100-240 volts, AC, 50-60 Hz Plug the power cable that was include with your Encoder to this connector and plug the opposite end into an AC power source or electrical wall outlet.</p>
 <p>+14VDC AUX IN</p>	<p>DC Power connector for 14 volts DC This allows a 14 volt battery to connect to the Encoder. Encoder is compatible with Anton/Bauer® Digital Dionic batteries.</p>

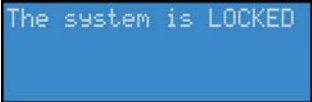
Analog Inputs – Video	
 VIDEO IN	Composite BNC input Encoder includes a BNC-to-RCA adapter so you can connect a composite RCA video cable to this BNC connector. Composite RCA connectors are found on most video playback equipment such as video players and video cameras. Composite BNC connectors are found on professional video playback equipment.
 S-VIDEO	S-Video input This is a standard consumer video connector found on most video players and video cameras.
Analog Inputs – Audio	
 UNBAL AUDIO	Unbalanced Audio input These RCA connectors provide left and right stereo input. RCA connectors are a standard consumer stereo audio connection found on most video players and video cameras.
 LEFT - BALANCED - RIGHT	Balanced Audio input These XLR connectors provide left and right balanced stereo input. XLR connectors are used by professional audio engineers and are found on high-end audio and video playback equipment. NOTE: A microphone preamplifier or mixer with XLR preamp functions is required to connect a XLR microphone to the Balanced Audio Input.
Output/Network Connection	
 OUTPUT PRI ETHERNET SEC	RJ-45 connector Encoder provides two network connections. These connectors are also referred to as output connectors because Encoder sends video and audio over an IP network which these connections provide.
Maintenance Connectors	
 WARNING: SHOCK HAZARD DO NOT OPEN - NO USER SERVICEABLE PARTS INSIDE	The mouse, keyboard, and VGA connections are used only for service and maintenance by a qualified ViewCast field technician. NOTE: Using a mouse, keyboard and VGA monitor for operation is not recommended. Third-party software installation or hardware modifications will void warranty.
Other Connectors & Controls	
 USB	USB port The USB port is used to connect external storage devices such as a USB drive for transferring files from Encoder to another system.
 FRONT PANEL LOCKED	Lock Switch When the Encoder is powered on, the front panel buttons are inactive





	<p>when the Lock Switch is in the “locked” position. When the Encoder is off, the front panel Power button will be deactivated if the Lock Switch is in the “locked” position. This will prevent the Encoder from inadvertently being powered on if connected to a battery during transport.</p> <p>Please see below the screen display you will see when the system is locked.</p>  <p>System information will continue to cycle at the bottom of the screen, but the words <i>The system is LOCKED</i> will remain at the top of the screen.</p>
	<p>Status Lights</p> <p>The “P” light indicates if the Encoder is powered on.</p> <p>The “A” light indicates hard drive activity.</p>



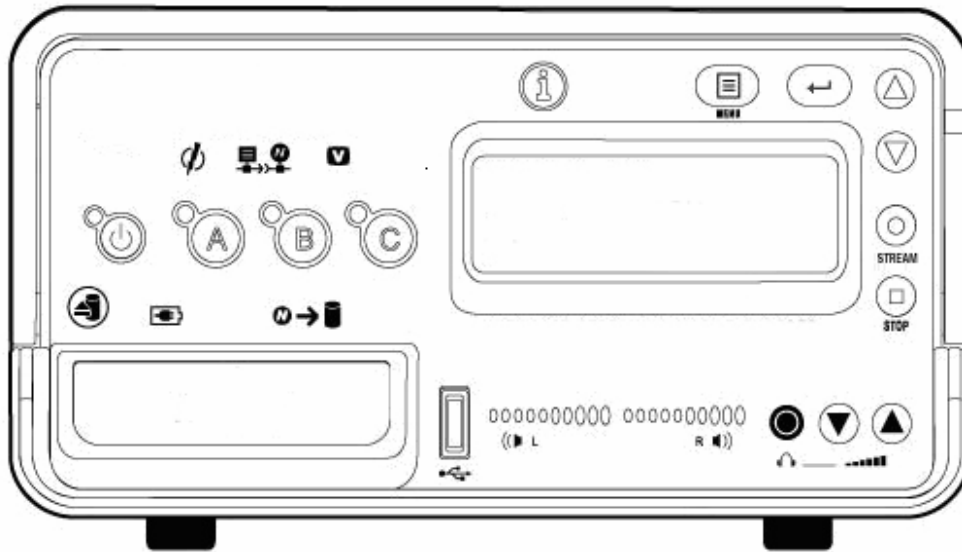









The Cisco Digital Media Encoder 1000 Front Panel Diagram

You should familiarize yourself with the front panel controls for the Niagara Encoder. Besides the basic buttons for power, start/stop, up/down and menu access, there are many indicator lights that are hidden until illuminated. The diagram and table below illustrates all buttons and lights so you can review the front panel functions and interface.

Front Panel

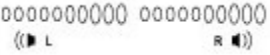

Control Buttons	
	<p>Power Pressing this button once will power up Encoder. When Encoder is powered up, pressing this button once will power down the system.</p>
	<p>EZStream[®] Buttons When an encoder profile is assigned to one of these buttons, pressing the assigned button and then the Stream button will start the encoder. Pressing the assigned button and then the Stop button will stop the encoder.</p>
	<p>Alarm Information When the Alarm Light indicator is lit, pressing this button will provide a log of the most recent alarms recorded. Pressing the Enter button will clear these alarms from the log.</p>
	<p>Menu Pressing this button will activate the Encoder menu on</p>

	the LCD display.
	Enter Pressing this button will enter or accept the menu choice highlighted on the LCD display. It is used for encoder menu operations.
	Up/Down These buttons are used for encoder menu navigation on the LCD display.
	Stream Pressing this button when an encoder profile is highlighted in the LCD display will start the encoder.
	Stop Pressing this button when an encoder profile is highlighted in the LCD display will stop the encoder.
	Unmount Pressing this button will activate the process in the encoder menu for un-mounting a USB device from the encoder.
Indicator Lights	
	Alarm This light indicates that an application alert has occurred.
	Remote Control This light indicates that another user is accessing the Encoder across the network from a computer.
	Video Sync This light indicates when the Encoder detects that a video source is connected to one of its video inputs. NOTE: This light will only illuminate when an encoder has been started.
	Battery Charging This light indicates that an attached USB device's battery is being charged.
	Disk Activity This light indicates when encoder's hard drive is active.
	Audio Activity These lights indicate audio input presence.
Connectors	
	USB port The USB port is used to connect external storage devices such as a USB drive for transferring files from the encoder to another system.

	<p>Headphone Jack & Volume Buttons The jack allows headphones to be connected to the encoder for audio monitoring. The Volume Buttons control the audio level on the headphones.</p>
---	---

Configuring the Cisco Digital Media 1000 Encoder

Initial Start Setup

The first time the encoder is powered, the LCD display will be presented with a series of menus that will assist in setting up the system clock, date, and video input format (NTSC (North America/Japan) or PAL).

To start the encoder, press the **<POWER>** *button* located on the front panel.



During the power up process, the Encoder LCD readout displays the following message:

```
ViewCast Corporation
Niagara 2.0.0.45
Serial: G55072117
Booting ...
```

After the encoder powers up the first time, it displays the following message:

```
Welcome to setup:
Set time, date, and
video format.
PRESS ENTER ...
```

Press the **<ENTER>** button to begin the initial setup.



Encoder will now ask you to set the date.

```
Enter Date
MM-DD-YYYY
06-15-2006
Enter to Accept
```

To set the time, use the **<UP>** and **<DOWN>** *arrow keys* to increment the numerical value of the month.



Once you set the numerical value for the month, press the **<STREAM>** *button* to move to the *day field*.



Again, use the <UP> and <DOWN> *arrow keys* to increment the numerical value of the day.



Press <STREAM> to enter the value and move to the *year field*.



Use the same process for setting the month and day so that you may set the year.

If you want to change a previous setting, you can continue pressing the <STREAM> *button* until the cursor cycles around to the month.



Once you are satisfied with your settings, you then press the <ENTER> *button* to accept the settings and move to the next screen to set the system clock.



The Encoder uses Military Time, which is a 24-hour clock format, for its system clock entries.



Use the <UP>, <DOWN>, <STREAM>, and <ENTER> *buttons* to set the hour and minute of the system clock.



The last setting is the selection of the video input format that you will enter into the Encoder.

You will see the following prompt message.



Press the <ENTER> *button* to continue.



Select your video source format from either NTSC or PAL.



Press the <ENTER> *button* to set the format, and the final screen will appear confirming that you have successfully set up your Encoder.

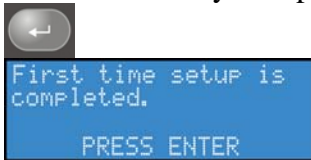

Press the <ENTER> *button* to exit the setup menu and begin using your Encoder.



Configuring Cisco Digital Media 1000 to Connect to an IP Network

NOTE: If you are not familiar with network protocols, please contact your network administrator for assistance.

The encoder network settings for both its 100 megabit and 1 gigabit network interface default to dynamically obtain an IP address from a DHCP server on the network.

If a DHCP server is not available or cannot be found on the network, then the encoder will assign its own IP address.

For most network environments, it will not be necessary to modify these default settings. However, if you wish to assign a static IP address to the encoder's Network Interface Cards (NICs), then you can change the network setting using the encoder front panel menu.

Changing the Cisco Digital Media 1000 Network Settings

Press the *Menu button* to access the encoder's *EASE menu*.



The *EASE menu options* are as follows:

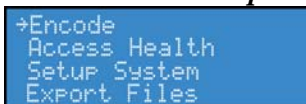

Use the <UP> and <DOWN> *buttons* to move the select arrow in the menu until the arrow points to *Setup System option*.



Now, press the **<ENTER>** *button*.



The Cisco Digital Media 1000 LCD readout will display the *Setup* menu. Using the **<UP>/<DOWN>** *buttons*, select *Network* and press the **<ENTER>** *button*.



Select the network interface you wish to modify and then press **<ENTER>**.

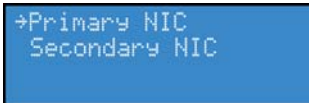

Select *Change Settings* and press the **<ENTER>** *button*.



The next menu presents the various network settings. Selecting one of these menu items allows you to change these individual settings. Once you modify these settings, the changes will be saved until you modify the settings again or you until restore the Cisco Digital Media 1000 back to its original factory settings.

Select *DHCP On/Off*, then press the **<ENTER>** *button*. If you wish to cancel this process, press the **<MENU>** *button* to return to the main menu.

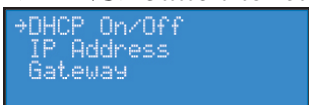

The following pictures and their respective actions represent your choices.



Press this *button* to select and continue.



Press this *button* to cancel and exit.

The next *menu* offers you the choice to enable DHCP for the network interface.



Using the <UP> and <DOWN> *buttons*, you can toggle the selection from the *No* to the *Yes option*. After you make your selection, press the <ENTER> *button* to input the change. The encoder will confirm that you wish to change this setting.

```
Confirm Enable DHCP
for NIC Nic2?
  →Yes  No
```

Press <ENTER> to confirm your choice. The encoder will return to the menu to select another individual setting to modify.

```
→DHCP On/Off
IP Address
Gateway
```

To input a static address for the IP address and/or Gateway, select either from the menu and press the <ENTER> *button*.

Using the <UP> and <DOWN> *arrow keys* to increment numerical value, enter a static IP address. Press the <STREAM> *button* to move to the next field. When you have correctly entered the IP address or Gateway address, press <ENTER> to input the data into the encoder. When setting a static IP address, a screen will appear that will allow you to set the subnet address.

```
IP Address:      Gateway Address:
000.000.000.000 000.000.000.000
Press Enter      Press Enter
```

```
Subnet
000.000.000.000
Press Enter
```

If you wish to remove a static IP address and/or Gateway previously set on the encoder, simply enable DHCP by using the method described directly above. Any previously entered static address will be removed.

WHAT IS STREAMING MEDIA?

Streaming media is media that is consumed (read, heard, viewed) while it is being delivered. Streaming is more a property of the delivery system than the media itself. The distinction is usually applied to media that is distributed over computer networks; most other delivery systems are either inherently streaming (radio, television, Internet TV) or inherently non-streaming (books, video cassettes, audio CDs).

The Cisco Digital Media 1000 is designed specifically for streaming audio and video media over an IP network.

Streaming Infrastructure

Before setting up your new Encoder, it is useful to understand the complete overview of live streaming video – from video capture to streaming video playback.

There are many applications for capturing video into the computer environment that can range from DVD authoring to live Web casting. Regardless of the final use of the video, all can be categorized into three main workflow processes:

- Single video/session capture (i.e. one-off file capture for non-real time delivery)
 - Typically the captured file is then processed and/or authored into its final form for delivery
- Batch video/session capture (i.e. archiving, scheduling and storage)
 - Multiple source content is to be digitalized
 - Device control is needed for unattended source
 - Ability to schedule sessions is needed to capture timed events
- Live video capture, processing and delivery (Web casting)
 - Can be single or multiple sources
 - Live event at a specific time
 - Can be a remote or local capture
 - Final content is delivered in real time to viewers

Each category has its unique set of requirements that also dictates different user interfaces, functionality and experiences. The encoder is designed for live video capture, processing and delivery.

Below is a diagram illustrating the video path starting with the source, like a camera or video player, going through the encoder, to the server, across an IP network, to a software player and displayed on a monitor for audience viewing.

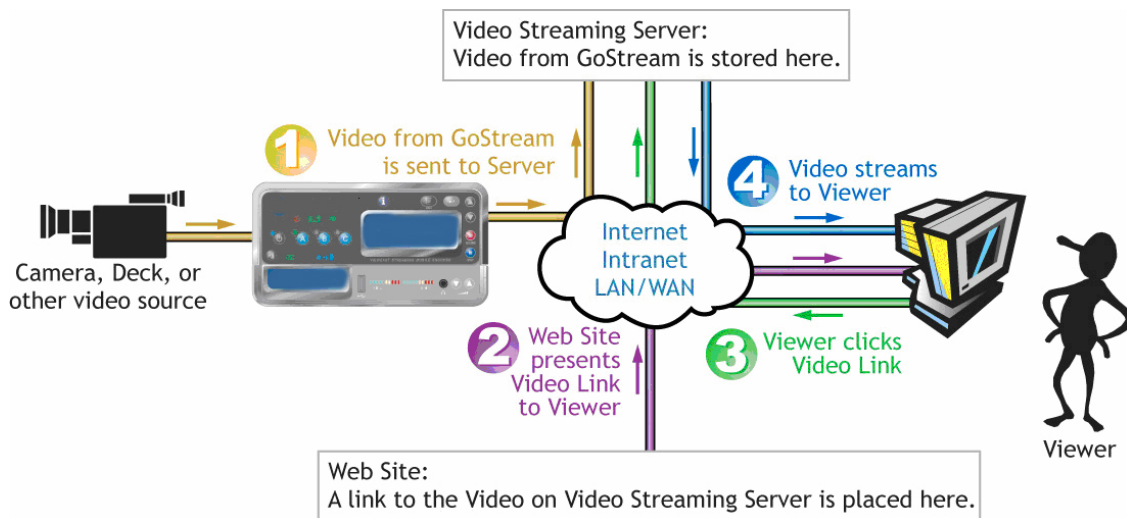

Guide to Streaming Audio and Video Types

Encoder can create several different types of audio and video streams. Although all are a type of IP video format, each has certain properties that make it more attuned to a specific streaming video application. The Cisco Digital Media Encoder 1000 was designed for creating video content in a reduced resolution to allow the content to be streamed across the Internet to be played back on a computer or a handheld mobile device.

The follow chart lists all formats supported by the encoder with suggested application uses. All of these formats can be used for many different applications. This chart relates to CIF or lower resolution streaming only.

IP Video Compression for Streaming in CIF Resolution & Lower

Windows Media [®]	Streaming Internet video and mobile devices
RealVideo [®] /Helix [®]	Streaming Internet video and mobile devices
MPEG-4	Handheld devices and mobile phones

In choosing the right streaming format for your needs, you should first consider the audience to which you will be sending your content. What is the most common player that they will have available to watch your content? This will determine the format of the stream that you will create for your audience.

To determine the data rate that you will stream your content; you will need to determine the IP bandwidth to which your audience has access.

For example, if the access method uses an ISDN connection or less, then you would stream your video and/or audio at a low data rate such as QCIF at 56kbps. If the access is much greater like a cable modem or DSL connection, then you can provide a higher quality stream at CIF resolution at 500kbps.

The encoder provides preconfigured encoding profiles for different bandwidth connections. The profiles loaded will depend upon how you configure your encoder on its initial startup.

To view the streams generated by the Cisco Digital Media Encoder 1000 you will need to download and install the correct viewer application. The use of these viewer applications is governed by the license agreement, if any, accompanying the viewer application.

TUTORIAL: GETTING TO KNOW YOUR CISCO DIGITAL MEDIA 1000

There are two interfaces for operation of your encoder.

- 1) The encoder's front panel LCD display and *buttons*



- 2) The *Niagara SCX Web Interface*



NOTE: To access the *Niagara SCX Web Interface*, you will need a computer with a current Web browser installed that has an IP connection to the encoder via a local network on which both the encoder and the computer reside or through a direct IP connection using the included RJ45 cable to connect directly from the encoder to a computer.

This tutorial is divided into two parts: using the front panel of the encoder and using the *Niagara SCX Web Interface*.

Basic Operation: Using the Cisco Digital Media 1000 Front Panel

Startup

NOTE: If this is the first time that the encoder has been started, please read the previous section entitled *First Start Setup* before continuing.

To start your encoder, press the <**POWER**> *button* on the front panel.



While powering up, the encoder LCD readout will display the following series of messages:

ViewCast Corporation GoStream 1.0.0.17 Serial: 650000000	Starting OS ..	Initializing System	Starting SCX
Starting System	System initializing Testing...	System initializing Loading Encoders...	

When *System is Ready* for operation, the encoder LCD display will alternate between status readouts that are similar to the following:

System is Ready	+CIF_AVI Stopped
Name: 65000091	CIF_R_350K Stopped
	CIF_R_768K Stopped
	CIF_WL350K Stopped

Shutdown

To shutdown the encoder, briefly press the *Power button* on the front panel.



The Encoder LCD readout will display the following messages:

System Stopping.	ViewCast Niagara System is shutting down - Please Wait
------------------	--

After a few seconds, the encoder will power off.

Caution: Allow the encoder to power down normally. If you force the system to shutdown improperly, data can be corrupted. If so, the next time the system is started it can take several minutes to complete startup.

Alternate Shutdown Method

Alternatively, you can shut down the Encoder using the **EASE** menu.

Press the **<MENU>** *button* to display the **EASE** menu.



Using the **<UP>** and **<DOWN>** *arrow buttons*, scroll down until **Shutdown System** is displayed and selected.

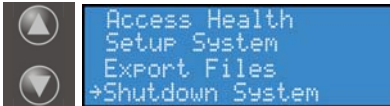

Press **<ENTER>**.



Then confirm that you wish to shut down the system using the **<UP>** and **<DOWN>** *buttons* to select either **Yes** or **No**. Press **<ENTER>**.



Starting an Encoding Session

Press the **<STREAM>** *button* to start an encoding session using the front panel of your encoder.



The encoder LCD readout will display a list of available encoder profiles that can be used together with the current status of each.

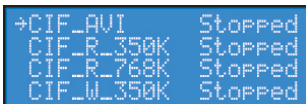

NOTE: The name of each encoder profile is abbreviated to display the first 10 characters. When creating names for custom profiles, be sure to create unique names that will be distinguishable by the first ten characters.

Use the **<UP>** and **<DOWN>** *buttons* to move the select arrow to point to the encoder profile that you want the encoder to use for this encoding session.

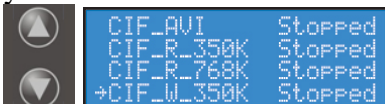

Once you select the encoder profile you need, press the **<STREAM>** *button* again to start the encoder.



The encoder LCD readout then displays messages about the encoder start process.



After the encoder session has successfully begun, the encoder LCD readout returns to the previous display of available encoders. The screen will indicate that the encoder profile you selected has begun encoding.

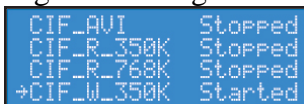

The video detection light illuminates if horizontal video sync is detected on either the S-Video or Composite video input of encoder.



If the encoder you started was assigned to one of the **EZStream ABC buttons**, the corresponding button flashes and steady illuminates during and after the starting process.



By repeating this method, you can quickly start multiple encoders at the same time.

The encoder is a single-channel encoder, which means that you can only connect and stream one audio and video source at any given time. However, you can stream the same audio and video at multiple data rates and multiple formats to provide the best user experience for different viewing audiences.

For example, you can stream Windows Media at CIF resolution at 250kbps and the same time stream RealVideo at CIF resolution at 300kbps.

WARNING: There are limitations to the number of streams that you can capture simultaneously. If you attempt to capture more streams than the encoder is capable of processing simultaneously, the streams will drop frames and the video will appear to stutter resulting in a poor viewer experience. If the number of sessions is not reduced in order to reduce CPU load, all encoding sessions could self-terminate without warning.

Checking CPU Usage

Since you are able to start multiple streams, understanding how much of the processing power of the encoder is being used is invaluable. If you are using less than 50%, then you should be able to start another encoding session without adversely affecting system performance.

Press the **<MENU>** *button* to display the main menu on the encoder LCD readout.



The LCD readout will display the following menu choices:

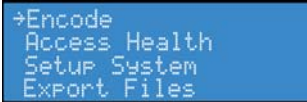

Using the **<UP>** and **<DOWN>** *buttons*, move the arrow until it is next to the menu item **Access** and then press the **<ENTER>** *button*.

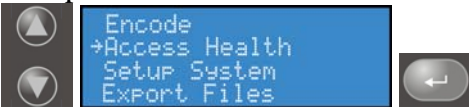

The LCD readout will display the **Access** menu choices. Press the **<ENTER>** *button* with **CPU** menu item selected.



The encoder's LCD readout displays the amount of CPU cycles in use. When the encoder is idle (no encoder sessions running), the CPU percent displayed should be 4% or less. If one or more encoder sessions are running, then the percent displayed will be much higher and will fluctuate in a range of +/- 10 percentage points.



Press the **<ENTER>** *button* to return to the previous menu.



Stopping an Encoding Session

To stop an encoder, press the **<STOP>** *button*.



The encoder LCD readout displays the list of encoding and shows the current status of each session.

```
→CIF_AVI Stopped
CIF_R_350K Stopped
CIF_R_768K Stopped
CIF_W_350K Started
```

Using the <UP> and <DOWN> *buttons*, move the pointer to the position next to the encoding session you want to terminate.

```
▲ CIF_AVI Stopped
▼ CIF_R_350K Stopped
  CIF_R_768K Stopped
→CIF_W_350K Started
```

Press the <STOP> *button* again and the encoder session selected will terminate.

```
CIF_W_350K Stopping
CIF_W_350K Stopped
```

To return to the main menu, press the <MENU> *button*.



Connecting an external storage device

The encoder front and rear panels each provide USB ports. You can connect almost any standard USB flash drive to one or both of these ports. This allows you to export any AV files you may have created on the encoder’s local storage drive. The local storage drive is the D drive when you use the *Save to File setting* while you employ the *Niagara SCX Web Interface*.

When you insert a USB flash drive in one of the USB ports on the Encoder, Encoder automatically detects the removable storage device and assigns a random drive letter to the device. This device can capture files directly or can be employed to use the encoder *Export File* function which is available for access when using the front panel menu.

Exporting Captured Video Files

You can export your captured video files to an external USB drive. Press the <Menu> button to access the encoder menu.

Using the UP/DOWN arrow buttons, highlights the “Export Files” option and press the <Enter> button.

```
Encode
Access Health
Setup System
→Export Files
```

Then select the “To USB Drive” option and press <ENTER>.

```
→To USB Drive
```

The next screen will ask you to select the drive destination and provide a list of active USB drives connect to the encoder.

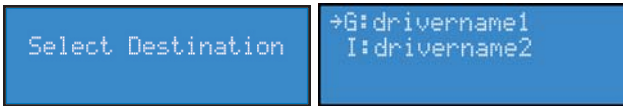

Select the USB drive to which you wish to export and press <ENTER>.



Once the encoder is finished exporting the file, you can remove drive.



The Unmount Button

The **Unmount button**, a picture of which is shown directly below, and which is located on the bottom left of your encoder, enables you to allow the encoder to unmount, or discontinue the operation of, a USB device. When you initially press the **Unmount button**, the following two screens appear. In the second screen, use the <UP> and <DOWN> **buttons** to move the pointer to the position next to the USB drive session you want to terminate.

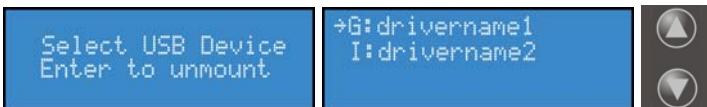

The USB session selected will terminate, and the following screens will appear.

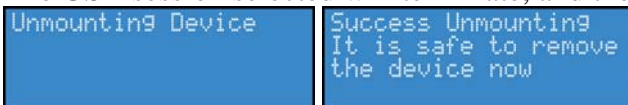

The encoder then returns to the screen cycling of system information.

Should you decide to terminate the unmounting of a USB drive, when you see the **Unmounting Device screen** shown above, press the <MENU> **button**. In this scenario, the <MENU> **button** acts as an escape from the current unmounting session.



After pressing the <MENU> **button**, you will see a screen informing you the session is **Aborting unmounting**.

```
Aborting unmounting
```

Once this screen returns to the screen cycling of system information, you can safely remove the USB device(s).

NOTE: If you inadvertently push the *Unmount button* and no USB devices are mounted to the encoder, you will see the following screens.

```
Select USB Device  
Enter to unmount
```

```
No USB Devices Found
```

The screen will remain at *No USB Devices Found* until you press the <MENU> *button*, which, once again, acts as an escape from the current unmounting session. You will then see the following screen, and then the screen cycling system information will begin again.

```
Aborting unmounting
```

WARNING Removing a USB device without unmounting could cause loss or corruption of data. Therefore, please be sure to follow the steps above before unmounting a USB device.

Advanced Operation: Using the Niagara SCX Web Interface

Accessing the Web Interface

The *Niagara SCX Web Interface* does not require software and works with any computer that has a current Web Browser, including Windows, Macintosh, and Linux machines. The encoder must either reside on a shared IP network with the computer or can be directly connected to a Windows computer using an Ethernet cable (RJ45).

To access the *Niagara SCX Web Interface*, open the Web browser on your computer and access the Web Interface by typing in the encoder machine name. The network name of the encoder is also its serial number and can be obtained from the LCD readout during the power up process.

If the encoder is already powered up, the serial number can be obtained from the LCD display while the system is idle.

At that time the encoder LCD display will alternate between readouts that are similar to the following display:



If the name is not immediately displayed on the *System is Ready* window, press the <UP> and <DOWN> *arrow buttons* to toggle through the system information until the name is displayed.

The serial number is also located on the bottom of the encoder.

Enter the encoder name in the Web Browser (as shown below) and press *enter*.

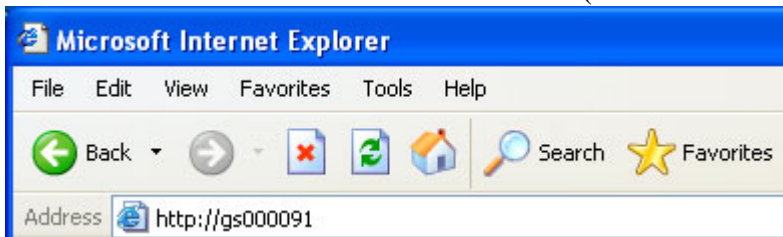

You will be prompted with a login screen that requires a user name and password. By default, the user name and password are both *admin*.

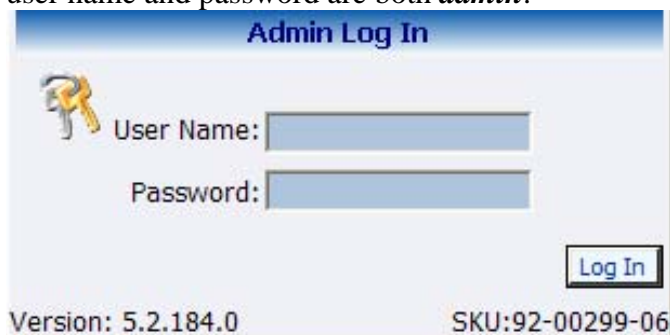

After logging in, you will have access to all of the Web-enabled functions including encoder operations, management, and system configuration tools.

NOTE: If you cannot browse to the encoder using its machine name, type in the encoder IP address instead. This information is also available from the *System is Ready* window when the system is idle.

Starting an Encoding Session

To start an encoding session, move the mouse pointer over *Encoders* in the menu bar and click on *All Encoders* in the drop-down menu.

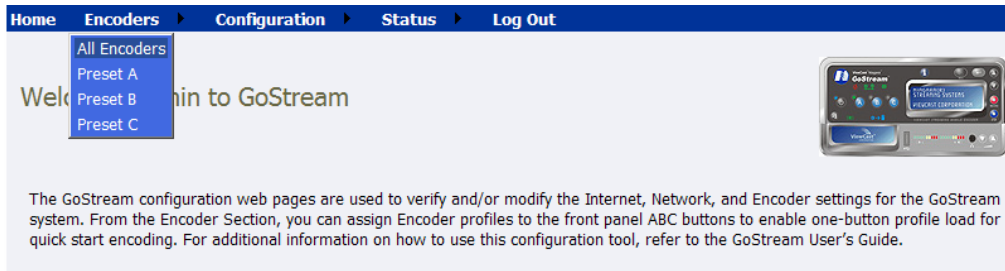

All of the encoder profiles loaded on the encoder will be presented in a list indicating format and current status.

Encoders
This page allows you to perform encoder setup and removal.

Auto refresh page [Add Encoder](#)

GoStream Encoders | Total records : 7

Name	Description	Last Status	Streaming	Preset
Edit Del CIF_AVI	AVI Encoder Driver	Encoder Stopped	Stopped	
Edit Del CIF_FLV_512K	Flash Encoder	OK	Stopped	
Edit Del CIF_RV_512K	Helix Producer Encoder	OK	Stopped	
Edit Del CIF_WM_500K	Windows Media Encoder	OK	Stopped	
Edit Del MPEG4	MPEG4 Encoder Driver	Started	Started	
Edit Del QCIF_RV_56K	Helix Producer Encoder	OK	Stopped	
Edit Del QCIF_WM_50K	Windows Media Encoder	OK	Stopped	

Press the red **Stream icon** located in the right column of the encoder you wish to start.



The Web page automatically updates with messages detailing the encoder start progress.

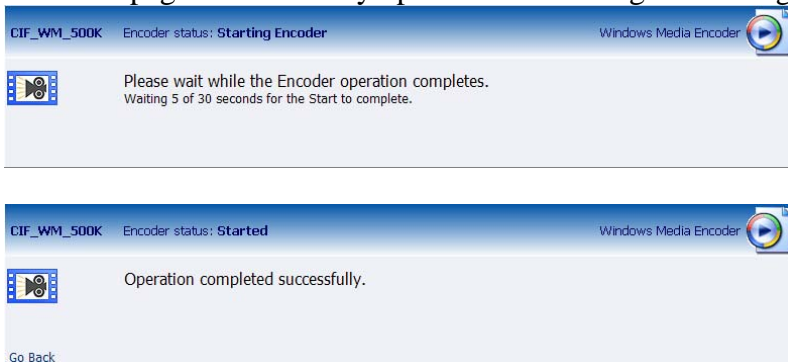

After the encoder has stopped successfully, the Web page will return to the *All Encoders page* with the encoder status updated to reflect the *Started* mode.

Encoders
This page allows you to perform encoder setup and removal.

Auto refresh page [Add Encoder](#)

GoStream Encoders | Total records : 7

Name	Description	Last Status	Streaming	Preset
Edit Del CIF_AVI	AVI Encoder Driver	Encoder Stopped	Stopped	
Edit Del CIF_FLV_512K	Flash Encoder	OK	Stopped	
Edit Del CIF_RV_512K	Helix Producer Encoder	OK	Stopped	
Edit Del CIF_WM_500K	Windows Media Encoder	OK	Stopped	
Edit Del MPEG4	MPEG4 Encoder Driver	Started	Started	
Edit Del QCIF_RV_56K	Helix Producer Encoder	OK	Stopped	
Edit Del QCIF_WM_50K	Windows Media Encoder	OK	Stopped	

Stopping an Encoding Session

If you are not already on the *All Encoders page*, move your mouse over *Encoders* in the menu bar and click *All Encoders* in the drop-down menu.

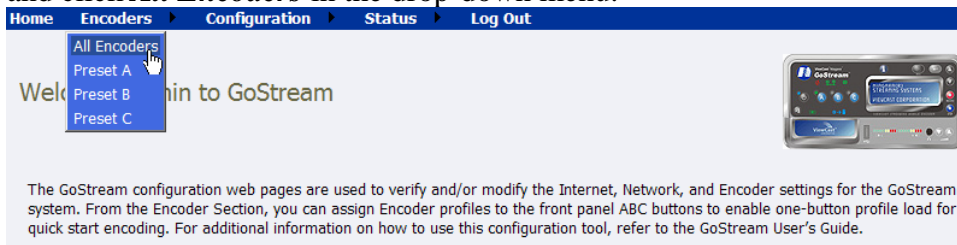

This will bring you to a Web page similar to the following.

Encoders
This page allows you to perform encoder setup and removal.

Auto refresh page [Add Encoder](#)

GoStream Encoders | Total records : 7

Name	Description	Last Status	Streaming	Preset
Edit Del CIF_AVI	AVI Encoder Driver	Encoder Stopped	Stopped	
Edit Del CIF_FLV_512K	Flash Encoder	OK	Stopped	
Edit Del CIF_RV_512K	Helix Producer Encoder	OK	Stopped	
Edit Del CIF_WM_500K	Windows Media Encoder	OK	Stopped	
Edit Del MPEG4	MPEG4 Encoder Driver	Started	Started	
Edit Del QCIF_RV_56K	Helix Producer Encoder	OK	Stopped	
Edit Del QCIF_WM_50K	Windows Media Encoder	OK	Stopped	

Press the blue icon, which indicates it is a streaming encoder, located in the right column of the encoder you wish to stop.

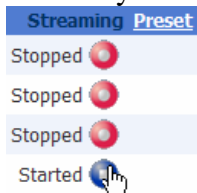

The Web page automatically updates with messages detailing the encoder stop progress.

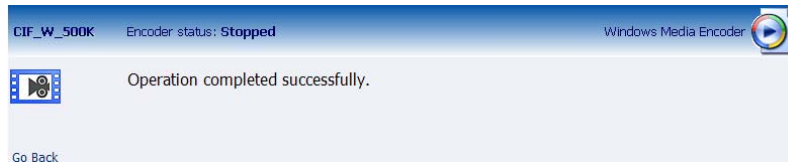
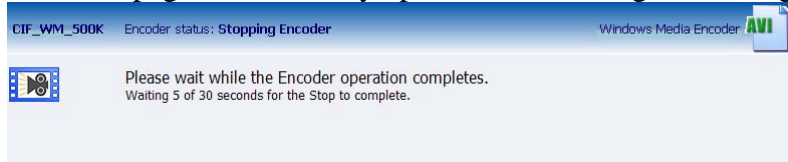

After the encoder has stopped successfully, the Web page will return to the *All Encoders page* with the encoder status updated to reflect *Stopped mode*.

Encoders
This page allows you to perform encoder setup and removal.

Auto refresh page [Add Encoder](#)

GoStream Encoders | Total records : 7

Name	Description	Last Status	Streaming Preset
Edit Del CIF_AVI	AVI Encoder Driver	Encoder Stopped	Stopped
Edit Del CIF_FLV_512K	Flash Encoder	OK	Stopped
Edit Del CIF_RV_512K	Helix Producer Encoder	OK	Stopped
Edit Del CIF_WM_500K	Windows Media Encoder	OK	Stopped
Edit Del MPEG4	MPEG4 Encoder Driver	Started	Started
Edit Del QCIF_RV_56K	Helix Producer Encoder	OK	Stopped
Edit Del QCIF_WM_50K	Windows Media Encoder	OK	Stopped

Viewing the Encoder Activity Log

The Activity Log records the encoder Start and Stop events. To view the Activity Log, move the mouse pointer over *Status* in the menu bar and click on *Activity Log* in the drop-down menu.

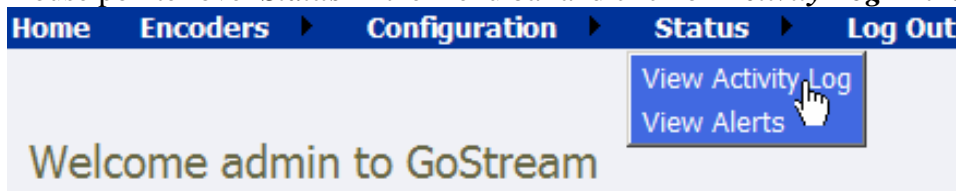

The log is updated for every event on the Cisco Digital Media 1000. The log now includes the starting and stopping events for the encoder from the previous sections.

Activity Log

View Activity Types: 

Activity Log | Total records : 4 

Created	Type	Description
6/10/2006 1:37:03 AM	General	CIF_W_350K Stopped
6/10/2006 1:36:54 AM	General	CIF_W_350K Stopping
6/10/2006 1:36:31 AM	General	CIF_W_350K Started
6/10/2006 1:36:30 AM	General	CIF_W_350K Starting

Each event is date and time stamped. Pressing the **Clear Activity Log button** in the upper-right clears all logged activities.

Configuring the EZStream Buttons

The Cisco Digital Media 1000 provides one-button streaming via the **EZStream buttons** located on the front panel of the system. By default, these buttons are not assigned to an encoder. The **Niagara SCX Web Interface** is used to configure each button to a specific encoder.

Move your mouse pointer over **Encoders** in the menu bar and click **Preset A** in the drop-down menu.



You are presented with the configuration page for the **EZStream A button**. This page contains a graphic representation of the front panel of the Cisco Digital Media 1000. The **A button** is highlighted on this graphic representing that you are actively assigning an encoder to this corresponding **EZStream button**.

Encoder Preset A

This page allows setting the GoStream Encoder Presets. A preset is a quick way to select a specific Encoder. There are three presets on the front panel A, B and C. Click on the **A**, **B** or **C** buttons below or select from the menu to switch between each preset.

When an Encoder is assigned to a preset button, pressing the button on the GoStream panel will allow for quick easy starting or stopping of the encoder. Select an Encoder for the preset or select 'None' to deactivate the GoStream> preset button. When no encoder assignment is made, pressing the GoStream button will show a message reminding you that no Encoder has been defined.

Select Encoder:

Click the drop-down list next to **Select Encoder**. This provides the complete list of encoders available on the system.

Select an Encoder for the preset or select 'None' to deactivate the GoStream preset button. Pressing the GoStream button will show a message reporting an **update** success.

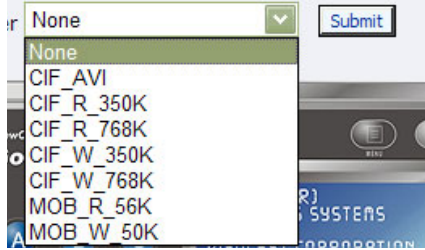

Select the encoder you wish to assign and click the **Submit** button.

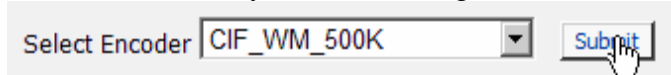

The Web page will update the **preset A** and provide a message reporting an **update** success.

Encoder Preset : A updated successfully
Encoder Preset A

This page allows setting the GoStream Encoder Presets. A preset is a quick way to select a specific Encoder. There are three presets on the front panel A, B and C. Click on the **A**, **B** or **C** buttons below or select from the menu to switch between each preset.

When an Encoder is assigned to a preset button, pressing the button on the GoStream panel will allow for quick easy starting or stopping of the encoder. Select an Encoder for the preset or select 'None' to deactivate the GoStream preset button. When no encoder assignment is made, pressing the GoStream button will show a message reminding you that no Encoder has been defined.

Select Encoder

By clicking on the **B** and **C** buttons on the encoder graphic, you can assign encoders to the **EZStream buttons** such as the following set forth in the diagram below.



After assigning encoders to the **A**, **B**, and **C** buttons, the **Presets column** on the **All Encoders page** updates to reflect these changes.

Encoders
This page allows you to perform encoder setup and removal.

Auto refresh page [Add Encoder](#)

GoStream Encoders | Total records : 9

Name	Description	Last Status	Streaming	Preset
Edit Del CIF_FLV_512K	Flash Encoder	OK	Stopped	
Edit Del CIF_RV_512K	Helix Producer Encoder	OK	Stopped	
Edit Del QCIF_WM_50K	Windows Media Encoder	OK	Stopped	
Edit Del REAL 1	Helix Producer Encoder	Started	Started	
Edit Del REAL 2	Helix Producer Encoder	Started	Started	
Edit Del FLASH ENCODER	Flash Encoder	OK	Stopped	
Edit Del MPEG4 ENCODER	MPEG4 Encoder Driver	OK	Stopped	A
Edit Del CIF_WM_500K	Windows Media Encoder	Encoder started	Started	B
Edit Del QCIF_RV_56K	Helix Producer Encoder	OK	Stopped	C

NOTE: It is not possible to assign the same encoder to two *EZStream buttons* simultaneously. If an encoder is already assigned to a button and you assign it to another button, the encoder will remove the association to the previous button in favor of the most current request.

AVI Encoder Properties

Encoder Properties | New Encoder Added

Name: Stopped AVI Encoder Driver

Video Settings

Source:

Input:

Signal:

Proportions:

Size:

Format:

Audio Settings

Source:

Input:

Preset

None

[Bottom](#)

Advanced Streaming Settings

SimulStream

Enable SimulStream

Enable multiple instances for each filter

Show filters per device.

Deinterlace

Type:

Motion Threshold

Smooth Sharp

Value:

Streaming to a File

Output to file

File Name:

[All Encoders](#) [Delete Encoder](#) [Top](#)

Encoder Preset (A, B, and C)

The encoder provides one-button streaming via the *EZStream buttons* located on the front panel of the system. By default, these buttons are not assigned to an encoder. The *Niagara SCX Web Interface* is used to configure each button to a specific encoder. The controls to configure these buttons are located in the *Encoder Preset A*, *Encoder Preset B*, and *Encoder Preset C* pages.

When you access the *Encoder Preset A page*, you are presented with the configuration option for the *EZStream A button*. On this page is a graphic representation of the front panel of the encoder. The *A button* is highlighted on this graphic representing that you are actively assigning an encoder to this corresponding *EZStream button*.

Encoder Preset A

This page allows setting the GoStream Encoder Presets. A preset is a quick way to select a specific Encoder. There are three presets on the front panel A, B and C. Click on the **A**, **B** or **C** buttons below or select from the menu to switch between each preset.

When an Encoder is assigned to a preset button, pressing the button on the GoStream panel will allow for quick easy starting or stopping of the encoder. Select an Encoder for the preset or select 'None' to deactivate the GoStream> preset button. When no encoder assignment is made, pressing the GoStream button will show a message reminding you that no Encoder has been defined.

Select Encoder



This page presents a *Select Encoder field* and a link at the bottom of the page to view the *View All Encoders page*. If an encoder has been assigned to the Preset, then you will also be presented with an *Edit link* next to the *View All Encoders link*.

Select Encoder

The *Select Encoder field* provides a drop-down menu which presents the complete list of all encoders available on the encoder.

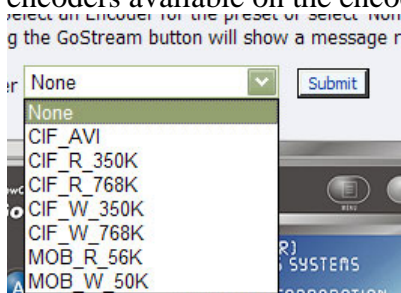

To assign an encoder, select an encoder from the list and, click the *Submit button*.

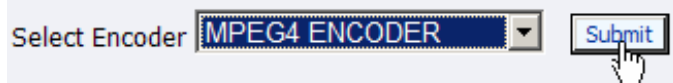

The Web page will update the **Preset A EZStream button** and report success.

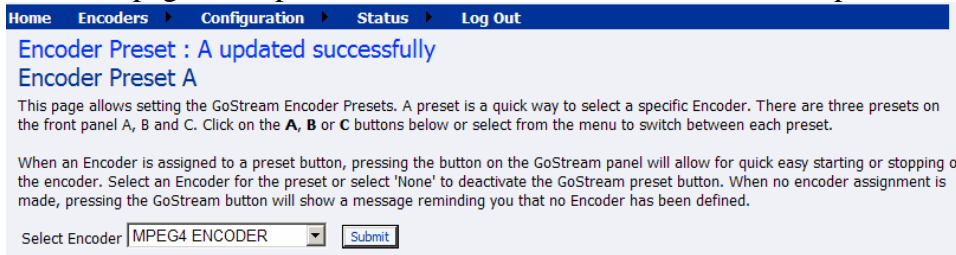

By clicking on the **B and C buttons** on the Cisco Digital Media 1000 graphic, you can assign encoders to those **EZStream buttons** in the same way. For example, below is a screenshot evidencing the creation of an AVI encoder by clicking on the **B button**.



NOTE: It is not possible to assign the same encoder to two **EZStream buttons** simultaneously. If an encoder is already assigned to a button and you assign it to another button, Cisco Digital Media 1000 will remove the association to the previous button in favor of the most current request.

View All Encoders

After assigning encoders to **A, B, and C buttons**, the **Presets column** on the **All Encoders page** is updated to reflect these changes. To view these changes, click the **View All Encoders link** at the bottom of the page.



Edit Preset Encoder Profile

After assigning encoders to the **EZStream buttons**, you can access the encoder editing page by clicking the **Edit button** at the bottom of the **Preset page**.

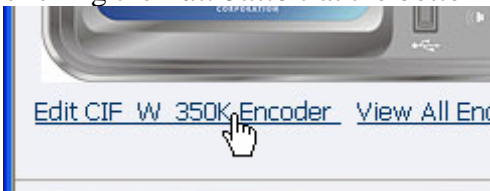

Flash Encoder Properties

Encoder Properties | New Encoder Added

Name: Stopped Flash Encoder

Video Settings	Audio Settings	Preset
<input checked="" type="checkbox"/> Source: <input type="text" value="Osprey-230 Video Device 1.5"/>	<input checked="" type="checkbox"/> Source: <input type="text" value="Osprey-230 Audio Device 1"/>	None
Input: <input type="text" value="Composite"/>	Input: <input type="text" value="Unbalanced"/>	
Signal: <input type="text" value="NTSC_M"/>		
Proportions: <input type="text" value="Standard"/>		
Size: <input type="text" value="400x300"/>		

Advanced Flash Video Settings	Advanced Flash Audio Settings
Frame Rate: <input type="text" value="29.9700000"/> fps	Format: <input type="text" value="44.100 kHz, 16 bit, Stereo"/>
Bitrate: <input type="text" value="320"/> kbps	Bitrate: <input type="text" value="64"/> kbps

[Bottom](#)

Advanced Streaming Settings

SimulStream

Enable SimulStream
 Enable multiple instances for each filter
Show filters per device.

Deinterlace	Motion Threshold
Type: <input type="text" value="Auto"/>	<input checked="" type="radio"/> Smooth <input type="radio"/> Sharp
	Value: <input type="text" value="15"/>

Streaming to a file

Output to file
File Name: ... [default folder](#)

[All Encoders](#) [Delete Encoder](#) [Submit](#) [Top](#)

MPEG-4 Encoder Properties

Encoder Properties | New Encoder Added

Name: H.264_CIF_250K Stopped MPEG4 Encoder Driver H.264

Video Settings

- Source: Osprey-230 Video Device 1.5
- Input: Composite
- Signal: NTSC_M
- Proportions: Standard
- Size: CUSTOM
- Width: 400 Height: 300

Audio Settings

- Source: Osprey-230 Audio Device 1
- Input: Unbalanced

Preset

None

Advanced MPEG Video Settings

- MPEG Type: H264 - MP4
- Encoder Quality: Real-time
- Frame Rate: 29.9700000
- Bitrate (kbps): 768
- Enable B-frames

Advanced MPEG Audio Settings

- Audio Format: 44.100 kHz, 16 bit, Stereo
- Audio Type: Low Complexity
- Audio Encoder: AAC
- Bitrate: 128

Streaming Properties

- Enable Streaming
- Destination IP: 192.168.1.1
- Callback IP: 192.168.1.100
- Video Port: 5555
- Audio Port: 5554
- Time to Live: 30
- Stream Info: Streaming Info...
- Stream Title: Streaming Stream
- SDP File: Streaming.sdp

Advanced Streaming Settings

SimuStream

- Enable SimuStream
- Enable multiple instances for each filter
- Show 5 filters per device.

Deinterlace

Type: Auto Motion Threshold: Smooth Sharp

Value: 10

Streaming to a file

- Output to file
- File Name: D:\AVFiles\Out\capture.mp4 default folder

Portable Media

- Enable Saving
- Media Title: [Empty]

All Encoders Delete Encoder Submit Top

NOTE: The preceding image is an example of saving to a file. MPEG files cannot be saved to a file and streamed simultaneously.

Encoder Properties | New Encoder Added

Name: H.264_CIF_250K Stopped MPEG4 Encoder Driver H.264

Video Settings	Audio Settings	Preset
<input checked="" type="checkbox"/> Source: Osprey-230 Video Device 1.5	<input checked="" type="checkbox"/> Source: Osprey-230 Audio Device 1	None
Input: Composite	Input: Unbalanced	
Signal: NTSC_M		
Proportions: Standard		
Size: CUSTOM		
Width: 400 Height: 300		
Advanced MPEG Video Settings	Advanced MPEG Audio Settings	
MPEG Type: H264 - MP4	Audio Format: 44.100 kHz, 16 bit, Stereo	
Encoder Quality: Real-time	Audio Type: Low Complexity	
Frame Rate: 29.9700000	Audio Encoder: AAC	
Bitrate (kbps): 768	Bitrate: 128	
Enable B-frames <input type="checkbox"/>		

[Bottom](#)

Streaming Properties	Advanced Streaming Settings SimulStream
<input checked="" type="checkbox"/> Enable Streaming	<input checked="" type="checkbox"/> Enable SimulStream
Destination IP: 239.1.1.1	<input checked="" type="checkbox"/> Enable multiple instances for each filter
Callback IP: 172.16.1.180	Show 5 filters per device.
Video Port: 5050	
Audio Port: 5052	
Time to Live: 30	
Stream Info: Stream Info Here.	Deinterlace
Stream Title: Streaming Server	Type: Auto
SDP File: c:\capture.sdp	Motion Threshold
<input type="checkbox"/> Enable Saving	<input checked="" type="radio"/> Smooth <input type="radio"/> Sharp
Media Title:	Value: 10
	Streaming to a File
	<input type="checkbox"/> Output to file
	File Name: D:\MPEG4\H264_CIF_250K.mpeg default folder

[All Encoders](#) [Delete Encoder](#) [Submit](#) [Top](#)

NOTE: The preceding image is an example of streaming. MPEG files cannot be saved to a file and streamed simultaneously.

Real Encoder Properties (Helix)

Encoder Properties | New Encoder Added

Name: Stopped Helix Producer Encoder

Video Settings	Audio Settings	Preset
<input checked="" type="checkbox"/> Source: Osprey-5X0 Video Device 1.6	<input checked="" type="checkbox"/> Source: Osprey-5X0 Audio Device 1	None
Input: Composite	Input: Unbalanced	
Signal: NTSC_M		
Proportions: Standard		
Size: QCIF 160x120		

[Bottom](#)

Streaming Properties	Advanced Streaming Settings
Real Streaming properties	Audience Selection <input type="checkbox"/> Enable SureStream
<input checked="" type="checkbox"/> Enable Streaming	<input type="checkbox"/> 100% Quality Download (VBR) <input type="checkbox"/> 5M Download (VBR)
Broadcast Method: Legacy Push (ver 8.x, 7.x, G2)	<input type="checkbox"/> 128k Dual ISON <input type="checkbox"/> 5M Multichannel (VBR)
Transport: <input checked="" type="radio"/> UDP <input type="radio"/> TCP	<input type="checkbox"/> 12k Substream for 28k Dial-up <input type="checkbox"/> 5M Surround Stereo (VBR)
Server Address: <input type="text"/>	<input type="checkbox"/> 150k LAN <input type="checkbox"/> 64k Single ISON
Port/Port Range: 4040	<input type="checkbox"/> 16k Substream for 28k Dial-up <input type="checkbox"/> 70% Quality Download (VBR)
Multicast Address: <input type="text"/>	<input type="checkbox"/> 1M Download (VBR) <input type="checkbox"/> 750k Download (VBR)
Listen Address: Automatic	Select all Unselect all
Stream Name: <input type="text"/>	SimulStream
Path(optional): <input type="text"/>	<input checked="" type="checkbox"/> Enable SimulStream
User Name: <input type="text"/>	<input checked="" type="checkbox"/> Enable multiple instances for each filter
Password: <input type="text"/>	Show <input type="text" value="5"/> filters per device.
Frame Rate: 15	Deinterlace Motion Threshold
Video Quality: Normal Motion Video	Type: Auto <input type="radio"/> Smooth <input type="radio"/> Sharp
Audio Content: Voice with Background Music	Value: <input type="text"/>
Video Noise Filter: Off	Streaming to a file
<input type="checkbox"/> De-Interlace filter	<input type="checkbox"/> Output to file
<input type="checkbox"/> Inverse Telecine	File Name: <input type="text"/> default folder

[All Encoders](#) [Delete Encoder](#) [Top](#)

Windows Media Encoder Properties

Encoder Properties

Name: Stopped Windows Media Encoder

Video Settings	Audio Settings	Preset
<input checked="" type="checkbox"/> Source: <input type="text" value="Osprey-230 Video Device 1.2"/>	<input checked="" type="checkbox"/> Source: <input type="text" value="Osprey-230 Audio Device 1"/>	None
Input: <input type="text" value="Composite"/>	Input: <input type="text" value="Unbalanced"/>	
Signal: <input type="text" value="NTSC_M"/>		
Proportions: <input type="text" value="Standard"/>		
Size: <input type="text" value="CIF 320x240"/>		

[Bottom](#)

Streaming Properties	Advanced Streaming Settings
Windows Media Capture Profiles: <input type="text" value="Windows Media 9 (50K) for Mobile Streaming"/> <small>37 of 55 Use this profile when creating video files for playback on most Pocket PCs.</small>	<input checked="" type="checkbox"/> Enable SimulStream <input type="checkbox"/> Enable multiple instance for each filter Show <input type="text" value="5"/> filters per device.
<input checked="" type="checkbox"/> Enable Pull Pull from Port: <input type="text" value="7008"/>	Deinterlace Type: <input type="text" value="Motion Adaptive"/>
<input type="checkbox"/> Enable Push Push to Port: <input type="text" value="80"/> Server: <input type="text"/> Alias: <input type="text"/> User Name: <input type="text"/> Password: <input type="text"/>	Motion Threshold <input checked="" type="radio"/> Smooth <input type="radio"/> Sharp Value: <input type="text" value="16"/>
<input type="checkbox"/> Enable Scripting	Streaming to a file <input checked="" type="checkbox"/> Output to file <input checked="" type="checkbox"/> Index the file File Name: <input type="text" value="D:\AVFiles\test.wmv"/> <input type="button" value="..."/> default folder
	<input type="checkbox"/> Enable DRM DRM Settings (Windows Media only) Profile: <input type="text" value="None"/> Description: None Key: N/A
	<small>Note: Changing the capture profile may change the current video height/width settings as well as the audio/video input capture selection.</small>

[All Encoders](#) [Delete Encoder](#) [Top](#)

For more information on setting up each type of encoder, proceed to the next section entitled *Editing an Encoding Profile*.

Editing an Encoder Profile

When you create a new encoder, you will be prompted to edit the new profile to your specific encoder settings and requirements. You can also edit the existing encoder profiles that are provided by default on Cisco Digital Media 1000. The property windows for editing a new encoder or an existing encoder are identical.





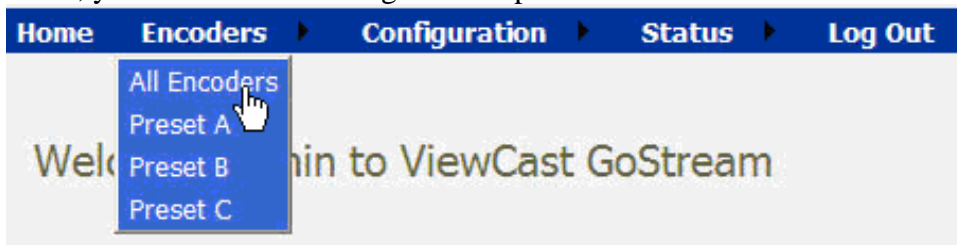

If you have performed the steps for adding an encoder, you should already see the *encoder properties page*.

If not, you can edit an existing encoder profile. Go to the *All Encoders screen*.



Click the *Edit link* next to the encoder whose properties you wish to modify.

GoStream Encoders | Total records : 9

Name	Description
Edit Del CIF_AVI  AVI Encoder Driver OK	
Edit Del CIF_FLV_512K  Flash Encoder OK	
Edit Del CIF_RV_512K  Helix Producer Encoder OK	
Edit Del CIF_WM_500K  Windows Media Encoder OK	
Edit Del QCIF_RV_56K  Helix Producer Encoder OK	
Edit Del QCIF_WM_50K  Windows Media Encoder OK	

The properties page for that encoder is then displayed.

Video & Audio Settings

Regardless of the encoder type, all types require that you set the audio and video properties. These values are the same for all encoder types except for the added color space setting for AVI and Flash.

You can enable or disable video and/or audio by clicking the check box next to **Source**: When enabled, the **Source**, **Input**, **Signal**, **Proportions**, **Size**, and **Input fields** can be edited.



Although the Cisco Digital Media 1000 is a single channel encoder, meaning you can only capture from one physical audio and video source at any given time, you can capture multiple streaming formats and resolutions simultaneously from the same video source. To accomplish this, the video source is seen as multiple inputs denoted by incrementing decimal values. They appear in the following manner:

- Osprey-230 Video Device 1.1
- Osprey-230 Video Device 1.2
- Osprey-230 Video Device 1.3
- Osprey-230 Video Device 1.4

Warning: Ensure that all of the encoders using the same video **Proportion** and **Size settings** also use the same video and audio source settings. For example, all encoders capturing at Standard proportion and CIF size are set to **Osprey-230 Video Device 1.1** while encoders capturing at Standard proportion but QCIF resolution are set to **Osprey-230 Video Device 1.2**.

Set **Input** for both video and audio to match the connectors on the back of the Cisco Digital Media 1000 to which you have connected your video and audio source. This would be either **Composite** or **S-Video** for video input and **Balanced** or **Unbalanced** for audio input.

When you performed the First Start Setup, you determine if your video signal was NTSC or PAL. The **Signal field** adds granularity for regional NTSC, PAL, and SECAM settings. If you are uncertain which setting applies, refer to the owner's manual for the video source you have connected to the Cisco Digital Media 1000 hardware.

The proportion setting uses the term **Standard**, meaning square pixels for a VGA monitor, and CCIR-601, meaning elongated pixels for a TV monitor. Choose the setting that reflects the type of display on which your content will be viewed. For example, if you will be streaming your video on

the Internet to be viewed on a computer monitor, select **Standard**. If the inaccurate setting is selected, your streaming video will be distorted.

The **Size field** refers to the pixel size of the encoded video. The standard sizes are as follows:

- Full-size for full screen video
- CIF for video scaled from full-size to one-fourth size
- QCIF for video scaled from full-size to one-fourth of CIF size

You can also specify a custom size for your video. This is useful when capturing video to be played on a mobile video device that requires a non-standard size for compatibility. If you select **Custom** from the drop-down menu, two additional fields will appear allowing you to type in the exact size you want the resulting video to be.

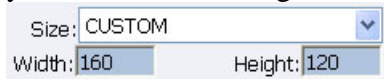

A screenshot of a video settings interface. The 'Size' dropdown menu is set to 'CUSTOM'. Below it, two input fields are visible: 'Width: 160' and 'Height: 120'.

NOTE: If you specify a video size that is not compatible with the color space of your source video, the encoder will automatically correct the size to the closest compatible setting when you click the **Submit button**. The color space format setting is only available in **AVI** and **Flash encoder properties** and appears as an additional field under the **Size setting** (see below).



A screenshot of the 'Video Settings' panel. It contains several dropdown menus: 'Source' (checked, Osprey-230 Video Device 1.4), 'Input' (Composite), 'Signal' (NTSC_M), 'Proportions' (Standard), 'Size' (CIF 320x240), and 'Format' (YUY2).

Now that you have completed all of the **Video** and **Audio settings**, you can proceed to the encoder type settings at the bottom of the page. As previously stated, these settings will vary according to the encoder type.

AVI Encoder Settings

AVI is an uncompressed audio and video storage format and therefore only has the ability to **save** to a file. You can type in a unique name for the generated AVI file and modify the directory path to the location the file will be stored. Clicking the **Default Folder link** will insert the path of the default folder for file storage on the encoder. By default the path is d:\AVFILES\.

NOTE: It is not recommend that you store files in any other directory on the Cisco Digital Media 1000. This directory provides approximately 30 gigabytes of data storage, which is not available on any other internal hard drive on the encoder.

Once you have saved your file to the Encoder internal hard drive, we recommend that you move the drive to another external storage device such as a USB drive or a network drive for backup purposes.

Streaming to a File

Output to file

File Name:

D:\AVFiles\CIF_AVI.avi [default folder](#)

After you have input your settings, click the **Submit button** at the bottom of the page to save your changes. **If you click away from the current page to another Web page without clicking *Submit*, your changes will be lost.**

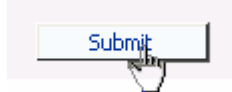

Flash Encoder Settings

The Flash encoder settings are similar to the AVI settings for saving the audio and video to a file. However, Flash adds some additional frame and bit rate controls. The frame rate changes the frames per second that the video will be encoded. The audio format setting can be used to modify the audio frequency and changes stereo to mono. The bit rate settings pertain to the amount of data per second the audio and video are captured. Decreasing the bit rate for both or either will decrease the playback viewing quality.

The Flash encoder creates a Flash format audio and video file. You can type in a unique name for the Flash file (.flv).

The screenshot displays the 'Encoder Properties | New Encoder Added' window for a Flash Encoder. The interface is organized into several sections:

- Name:** CIF_F_350K
- Status:** Stopped
- Video Settings:**
 - Source: Osprey-230 Video Device 1.5
 - Input: Composite
 - Signal: NTSC_M
 - Proportions: Standard
 - Size: 400x300
- Audio Settings:**
 - Source: Osprey-230 Audio Device 1
 - Input: Unbalanced
- Preset:** None
- Advanced Flash Video Settings:**
 - Frame Rate: 29.9700000 fps
 - Bitrate: 320 kbps
- Advanced Flash Audio Settings:**
 - Format: 44.100 kHz, 16 bit, Stereo
 - Bitrate: 64 kbps
- Advanced Streaming Settings:**
 - SimulStream:** Enable SimulStream, Enable multiple instances for each filter. Show 5 filters per device.
 - Deinterlace:** Type: Auto
 - Motion Threshold:** Smooth (selected), Sharp. Value: 10.
- Streaming to a file:** Output to file checked. File Name: D:\AVFiles\Out\test.flv

Navigation buttons include 'All Encoders', 'Delete Encoder', 'Submit', 'Bottom', and 'Top'.

After you have input your settings, click the *Submit button* at the bottom of the page to save your changes. **If you click away to another Web page without clicking *Submit*, your changes will be lost.**



MPEG-4 Encoder Settings

Encoder Settings Web Interface

The Cisco Digital Media 1000 software MPEG-4 compression engine provides H.263, MPEG-4 Part 2 SP/ASP, and H.264/MPEG-4 Part 10 Baseline encoding functionality. This product provides the capabilities to encode streams for Internet video, mobile phones, set top boxes and create media files for other MPEG-4 compatible devices such as iPods[®].

The Niagara SCX Web Interface provides options for basic and advanced settings for the video and audio options of MPEG-4 available with the encoder.

The figure below illustrates the screen you will see after creating an encoder through the Niagara SCX Web Interface.

Encoder Properties | New Encoder Added

Name: H264_CIF_250K Stopped MPEG4 Encoder Driver H.264

Video Settings	Audio Settings	Preset
<input checked="" type="checkbox"/> Source: Osprey-230 Video Device 1.5	<input checked="" type="checkbox"/> Source: Osprey-230 Audio Device 1	None
Input: Composite	Input: Unbalanced	
Signal: NTSC_M		
Proportions: Standard		
Size: CUSTOM		
Width: 400 Height: 300		
Advanced MPEG Video Settings	Advanced MPEG Audio Settings	
MPEG Type: H264 - MP4	Audio Format: 44.100 kHz, 16 bit, Stereo	
Encoder Quality: Real-time	Audio Type: Low Complexity	
Frame Rate: 29.9700000	Audio Encoder: AAC	
Bitrate (kbps): 768	Bitrate: 128	
Enable B-frames <input type="checkbox"/>		

[Bottom](#)

Streaming Properties	Advanced Streaming Settings
<input type="checkbox"/> Enable Streaming	<input checked="" type="checkbox"/> Enable SimulStream
Destination IP: 192.168.1.1	<input checked="" type="checkbox"/> Enable multiple instances for each filter
Callback IP: 192.168.1.100	Show 5 filters per device.
Video Port: 220	
Audio Port: 220	
Time to Live: 0	
Stream Info: Streaming to File	Deinterlace
Stream Title: Streaming to File	Type: Auto
SDP File: 192.168.1.100	Motion Threshold
	Value: 10
<input type="checkbox"/> Enable Saving	Streaming to a File
Media Title: 192.168.1.100	<input checked="" type="checkbox"/> Output to file
	File Name: D:\AVFiles\Out\capture.mp4 default_folder

[All Encoders](#) [Delete Encoder](#) [Top](#)

NOTE: The preceding image is an example of saving to a file. MPEG files cannot be saved to a file and streamed simultaneously.

Encoder Properties | New Encoder Added

Name: H.264_CF_250K Stopped MPEG4 Encoder Driver H.264

Video Settings	Audio Settings	Preset
<input checked="" type="checkbox"/> Source: Osprey-230 Video Device 1.5	<input checked="" type="checkbox"/> Source: Osprey-230 Audio Device 1	None
Input: Composite	Input: Unbalanced	
Signal: NTSC_M		
Proportions: Standard		
Size: CUSTOM		
Width: 400 Height: 300		
Advanced MPEG Video Settings	Advanced MPEG Audio Settings	
MPEG Type: H264 - MP4	Audio Format: 44.100 kHz, 16 bit, Ster	
Encoder Quality: Real-time	Audio Type: Low Complexity	
Frame Rate: 29.9700000	Audio Encoder: AAC	
Bitrate (kbps): 768	Bitrate: 128	
Enable B-frames <input type="checkbox"/>		

[Bottom](#)

Streaming Properties	Advanced Streaming Settings SimulStream
<input checked="" type="checkbox"/> Enable Streaming	<input checked="" type="checkbox"/> Enable SimulStream
Destination IP: 239.1.1.1	<input checked="" type="checkbox"/> Enable multiple instances for each filter
Callback IP: 172.16.1.180	Show 5 filters per device.
Video Port: 5050	
Audio Port: 5052	
Time to Live: 30	
Stream Info: Stream Info Here.	Deinterlace
Stream Title: Streaming Server	Type: Auto
SDP File: c:\capture.sdp	Motion Threshold
	<input checked="" type="radio"/> Smooth <input type="radio"/> Sharp
	Value: 10
Portable Media	Streaming to a File
<input type="checkbox"/> Enable Saving	<input type="checkbox"/> Output to file
Media Title: []	File Name: [] default folder

[All Encoders](#) [Delete Encoder](#) [Submit](#) [Top](#)

NOTE: The preceding image is an example of streaming. MPEG files cannot be saved to a file and streamed simultaneously.

The *Advanced MPEG Video Settings* provide you with the ability to choose the *MPEG Type* required for your output. As set forth in the figure and descriptions of the *MPEG Types* set forth below, these include the following:

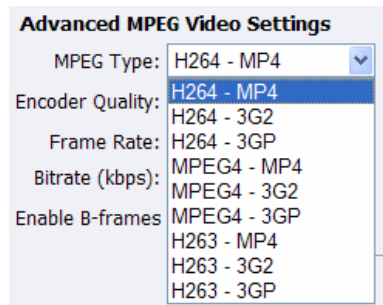

H.264 – MP4

H.264, MPEG-4, Part 10, or AVC (Advanced Video Coding) was designed for very high-data compression while maintain better quality than its predecessor, H.263. It was also created to address a broad range of applications from low bit rate to high bit rate and from low resolution such as cell phones to high resolution such as broadcast.

The encoder's H.264 is Baseline Profile.

H.264 – 3G2

This setting will create an H.264 stream stored in a 3G2 container.

H.264 – 3GP

This setting will create an H.264 stream stored in a 3GPP container.

MPEG4 – MP4

MPEG-4 is the basic MP4 compression which can be used for Web (streaming media) and mobile devices. Use this compression setting if you are experiencing compatibility issues with your playback software or device when using H.263 or H.264.

MPEG4 – 3G2

This setting will create an MPEG-4 stream stored in a 3G2 container.

MPEG4 – 3GP

3GP is a multimedia container format defined by the Third Generation Partnership Project (3GPP) for use on 3G mobile phones. It stores video streams such as MPEG-4 or H.264 and audio streams such as AMR or AAC.

There are two defined standards for this format which are:

- 1) 3GPP for GSM based mobile phones
- 2) 3GPP2 for CDMA based mobile phones

This setting will create an MPEG-4 stream stored in a 3GPP container.

H.263 – MP4

MPEG-4, Part 2, or H.263, is designed for situations where low bit rate and low resolution are mandated by other conditions of the applications, like network bandwidth or device size. Examples of video applications for H.263 are cell phones, some low end video conferencing systems, and surveillance systems. H.263 is important for legacy handheld devices that do not support H.264.

NOTE: By default, the encoder's H.263 uses Simple Profile unless you select the

“Enable B Frames” option. If B frames are enabled, then the resulting stream will be Advanced Simple Profile.

H.263 – 3G2

This setting will create an H.263 stream stored in a 3G2 container.

H263 – 3GP

This setting will create an H.263 stream stored in a 3GPP container.

Also included under **Advanced MPG Video Settings** are drop-down boxes for **Encoder Quality**, ranging from **Real-time** to **Highest**, along with **Frame Rate** and the **Bitrate (kbps)**.

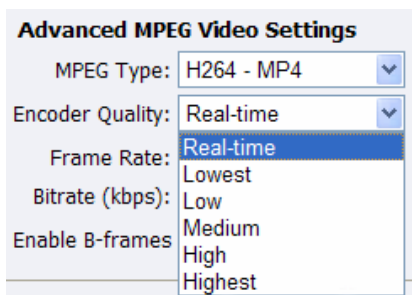

The screenshot shows the 'Advanced MPEG Video Settings' dialog box. It contains several dropdown menus: 'MPEG Type' is set to 'H264 - MP4'; 'Encoder Quality' is set to 'Real-time'; 'Frame Rate' is set to 'Real-time' with a list of options (Lowest, Low, Medium, High, Highest) visible below it; 'Bitrate (kbps)' is set to 'Low'; and 'Enable B-frames' is set to 'High'.

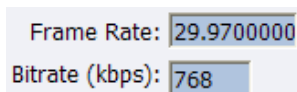

The screenshot shows two input fields: 'Frame Rate' with the value '29.9700000' and 'Bitrate (kbps)' with the value '768'.

NOTE: Some players, such as Quicktime[®] player, are not compatible with streams that include B frames. If your resulting stream has quality issues on playback, try disabling B frames to ensure compatibility with most players.

NOTE: The **Video/Encoder Quality** setting is currently not active and will not affect the results of the encoding stream or file.

The **Advanced MPG Audio Settings**, provide you with several **Audio Formats**, **Audio Types**, **Audio Encoders**, and **Bitrates** from which to choose. These choices include several options as to audio sampling, and whether the audio is to be encoded monophonically (mono) or stereo.

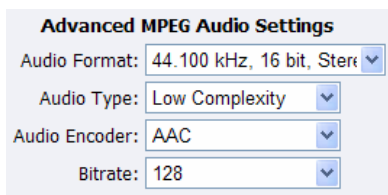

The screenshot shows the 'Advanced MPEG Audio Settings' dialog box. It contains several dropdown menus: 'Audio Format' is set to '44.100 kHz, 16 bit, Stere'; 'Audio Type' is set to 'Low Complexity'; 'Audio Encoder' is set to 'AAC'; and 'Bitrate' is set to '128'.

Advanced MPEG Audio Settings

Audio Format: 44.100 kHz, 16 bit, Stere

Audio Type: 11.025 kHz, 8 bit, Mono
11.025 kHz, 8 bit, Stereo

Audio Encoder: 11.025 kHz, 16 bit, Mono
11.025 kHz, 16 bit, Stereo

Bitrate: 22.050 kHz, 8 bit, Mono
22.050 kHz, 8 bit, Stereo
22.050 kHz, 16 bit, Mono
22.050 kHz, 16 bit, Stereo
33.075 kHz, 8 bit, Mono
33.075 kHz, 8 bit, Stereo
33.075 kHz, 16 bit, Mono
33.075 kHz, 16 bit, Stereo
44.100 kHz, 8 bit, Mono
44.100 kHz, 8 bit, Stereo
44.100 kHz, 16 bit, Mono
44.100 kHz, 16 bit, Stereo

The **Audio Type** setting is only related to **AAC Encoding**. If you select **AMR** in the **Encoder field**, this setting is not used. The **Audio Type** field provides you with a drop-down box, which includes two choices, as follows:

Main – This format is the same as LC (above), but adds backward prediction.

Low Complexity (LC) – The simplest and most widely used and support AAC audio format.

Advanced MPEG Audio Settings

Audio Format: 44.100 kHz, 16 bit, Stere

Audio Type: Low Complexity

Audio Encoder: Main
Low Complexity

Bitrate: 128

NOTE: Depending on the player on which the resulting stream will be heard, either choice will use a specific set of tools to encode the audio stream. You should make your choice based on the requirement of the playback software or device. The most widely supported format is LC profile.

The **Audio Encoder settings** provide you with a drop-down box, which includes two choices, as follows:

AAC (Advanced Audio Coding) is a standardized, lossy compression and encoding scheme for digital audio. AAC achieves better audio quality than MP3 and has been named a standard by the Motion Picture Experts Group (MPEG)

AMR (Adaptive Multi-Rate Narrow-Band) is an audio data compression scheme optimized for speech coding. AMR was adopted as the standard narrowband speech codec by 3GPP and is widely used in GSM.

Advanced MPEG Audio Settings

Audio Format: 44.100 kHz, 16 bit, Stere

Audio Type: Low Complexity

Audio Encoder: AAC

Bitrate: AAC
AMR-NB

NOTE: When you select AMR Encoder for audio, the audio will automatically be encoded using 8 kHz mono for playback on cell phones.

The **Audio Bitrate** drop-down box provides you with several choices, as can be seen in the figure below.

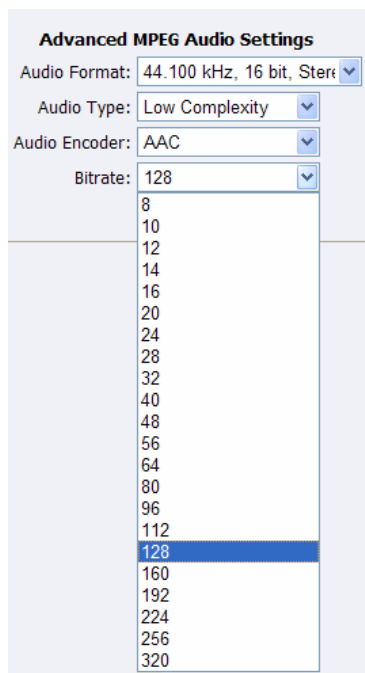

The screenshot shows the 'Advanced MPEG Audio Settings' interface. It includes several dropdown menus: 'Audio Format' (44.100 kHz, 16 bit, Stereo), 'Audio Type' (Low Complexity), 'Audio Encoder' (AAC), and 'Bitrate' (128). The 'Bitrate' dropdown menu is open, displaying a list of options from 8 to 320, with 128 selected and highlighted in blue.

Bitrate
8
10
12
14
16
20
24
28
32
40
48
56
64
80
96
112
128
160
192
224
256
320

The Web interface for the encoder includes options for **Streaming Properties** and **Advanced Streaming Properties**. As to the broadcast type you choose, you have the option to check the **Enable Streaming** box. Please see the following section entitled **Real Encoder (Helix)** for a more detailed description of enabling pull. Another option provides you the abilities to **Save to Portable Media** and provide a **Media Title**.

Encoder Properties | New Encoder Added

Name: H.264_CIF_250K Stopped MPEG4 Encoder Driver H.264

Video Settings	Audio Settings	Preset
<input checked="" type="checkbox"/> Source: Osprey-230 Video Device 1.5	<input checked="" type="checkbox"/> Source: Osprey-230 Audio Device 1	None
Input: Composite	Input: Unbalanced	
Signal: NTSC_M		
Proportions: Standard		
Size: CUSTOM		
Width: 400 Height: 300		
Advanced MPEG Video Settings	Advanced MPEG Audio Settings	
MPEG Type: H264 - MP4	Audio Format: 44.100 kHz, 16 bit, Stereo	
Encoder Quality: Real-time	Audio Type: Low Complexity	
Frame Rate: 29.9700000	Audio Encoder: AAC	
Bitrate (kbps): 768	Bitrate: 128	
Enable B-frames <input type="checkbox"/>		

[Bottom](#)

Streaming Properties	Advanced Streaming Settings SimulStream
<input checked="" type="checkbox"/> Enable Streaming	<input checked="" type="checkbox"/> Enable SimulStream
Destination IP: 239.1.1.1	<input checked="" type="checkbox"/> Enable multiple instances for each filter
Callback IP: 172.16.1.180	Show 5 filters per device.
Video Port: 5050	
Audio Port: 5052	
Time to Live: 30	
Stream Info: Stream Info Here.	Deinterlace
Stream Title: Streaming Server	Type: Auto
SDP File: c:\capture.sdp	Motion Threshold
	<input checked="" type="radio"/> Smooth <input type="radio"/> Sharp
	Value: 10
<input type="checkbox"/> Enable Saving	Streaming to a File
Media Title:	<input type="checkbox"/> Output to file
	File Name: D:\AVFiles\Out\capture.mp4 ... default folder

[All Encoders](#) [Delete Encoder](#) [Submit](#) [Top](#)

Under the *Advanced Streaming Settings* feature, you have the options to output to a file while streaming, or output only to a file. You must type in a unique name and location for this file. Check the *Save to Portable Media* box if you would like to save the encoded content to a file. Enter a file destination in the field provided.

Streaming to a File

Output to file

File Name:
D:\AVFiles\Out\capture.mp4 ... default folder

[Submit](#)

NOTE: Remember the file name is referenced to the encoder system, not to the system running SCX Explorer.

When SCX Manager and SCX Explorer are not on the same computer, always start your browse for files at **My Network Places** and work down or enter the entire file pathname beginning with the system name (e.g., \\fileserver\c\videos). If you simply enter a file name, you may inadvertently browse your local computer when the media file resides on the remote computer.

To stream your MPEG-4 content, select **Enable Streaming**. Set the appropriate streaming properties.

NOTE: The default settings will enable multicast streaming. If this is not desired, change the IP address for Group to the IP address of the server to which you want to stream from the encoder.

The **Save sdp file field** will require a name and destination path for the resulting SDP file created when the stream is started. If you are streaming to a Helix[®], a Quicktime, or a Darwin server, refer to its respective documentation or online message boards for setup details specific for the individual streaming server.

NOTE: You can stream point-to-point by selecting a share destination directory for the saved SDP file. Remember to disable multicasting by entering in the IP address of the PC to which you want to stream.

For example, if you want another PC to view the stream, save the SDP file to a share folder on the local drive. The other PC can open the SDP file and the stream can be played in a Quicktime or other MPEG-4 compatible streaming player. Since MPEG-4 encoding can be CPU intensive, it is not recommend that you view the stream on the same system as the Encoder encoder unless you have a very powerful system (dual-core processors or better). Doing so may overtax the host CPU which will cause video quality degradation and encode session failure.

After you have input your settings, click the **Submit button** at the bottom of the Web interface page to save your settings.

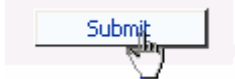

NOTE: If you click away to another Web page without first clicking **Submit**, your changes will be lost.

Real Encoder Settings (Helix)

Home Encoders Configuration Status Log Out

Encoder Properties

Name: Stopped Helix Producer Encoder

<p>Video Settings</p> <p><input checked="" type="checkbox"/> Source: <input type="text" value="Osprey-230 Video Device 1.4"/></p> <p>Input: <input type="text" value="Composite"/></p> <p>Signal: <input type="text" value="NTSC_M"/></p> <p>Proportions: <input type="text" value="Standard"/></p> <p>Size: <input type="text" value="CIF 320x240"/></p>	<p>Audio Settings</p> <p><input checked="" type="checkbox"/> Source: <input type="text" value="Osprey-230 Audio Device 1"/></p> <p>Input: <input type="text" value="Unbalanced"/></p>	<p>Preset</p> <p>None</p>
--	--	----------------------------------

Bottom

<p>Streaming Properties</p> <p>Real Streaming properties</p> <p><input checked="" type="checkbox"/> Enable Streaming</p> <p>Broadcast Method: <input type="text" value="Legacy Push (ver 8.x, 7.x, G2)"/></p> <p>Transport: <input checked="" type="radio"/> UDP <input type="radio"/> TCP</p> <p>Server Address: <input type="text"/></p> <p>Port/Port Range: <input type="text" value="4040"/></p> <p>Multicast Address: <input type="text"/></p> <p>Listen Address: <input type="text" value="Automatic"/></p> <p>Stream Name: <input type="text"/></p> <p>Path(optional): <input type="text"/></p> <p>User Name: <input type="text"/></p> <p>Password: <input type="text"/></p> <p>Frame Rate: <input type="text" value="15"/></p> <p>Video Quality: <input type="text" value="Normal Motion Video"/></p> <p>Audio Content: <input type="text" value="Voice with Background Music"/></p> <p>Video Noise Filter: <input type="text" value="Off"/></p> <p><input type="checkbox"/> De-Interlace filter</p> <p><input type="checkbox"/> Inverse Telecine</p>	<p>Advanced Streaming Settings</p> <p><input type="checkbox"/> Enable SureStream</p> <p><input type="checkbox"/> 100% Quality Download (VBR) <input type="checkbox"/> 5M Download (VBR)</p> <p><input type="checkbox"/> 128k Dual ISON <input type="checkbox"/> 5M Multichannel (VBR)</p> <p><input type="checkbox"/> 12k Substream for 28k Dial-up <input type="checkbox"/> 5M Surround Stereo (VBR)</p> <p><input type="checkbox"/> 150k LAN <input type="checkbox"/> 64k Single ISON</p> <p><input type="checkbox"/> 16k Substream for 28k Dial-up <input type="checkbox"/> 70% Quality Download (VBR)</p> <p><input type="checkbox"/> 1M Download (VBR) <input type="checkbox"/> 750k Download (VBR)</p> <p>Select all Unselect all</p> <p>SimulStream</p> <p><input checked="" type="checkbox"/> Enable SimulStream</p> <p><input checked="" type="checkbox"/> Enable multiple instances for each filter</p> <p>Show <input type="text" value="5"/> filters per device.</p> <p>Deinterlace</p> <p>Type: <input type="text" value="Auto"/></p> <p>Motion Threshold</p> <p><input checked="" type="radio"/> Smooth <input type="radio"/> Sharp</p> <p>Value: <input type="text" value="18"/></p> <p>Streaming to a File</p> <p><input type="checkbox"/> Output to file</p> <p>File Name: <input type="text" value="..."/> default folder</p> <p><input type="button" value="Submit"/></p> <p style="text-align: right;">Top</p>
---	---

[All Encoders](#) [Delete Encoder](#)

Real (Helix) is both a storage format and a streaming format. In addition to the ability to output to a file, the Real Encoder can stream to a Helix Server. The settings for the Real Encoder include the ability to adjust parameters for connecting and streaming to the server.

Broadcast Method: Legacy Push (ver 8.x, 7.x, G2)

Broadcast Method: There are several different broadcast types for streaming Real format video to a Helix Server, as follows:

- **Push, Account-Based Login (Helix Server)**
 - Account-based, push broadcasting allows you to send a stream to Helix Server version 9 or later. In this method, the encoder maintains a monitoring connection to Helix Server. This connection allows it to pass a user name and password to authenticate access to the server. Helix Server uses this connection to send statistics about the broadcast stream back to Encoder.
- **Push, Password-Only (Helix Server)**
 - Unlike account-based broadcasting, password-only broadcasting does not establish a monitoring connection. Therefore, this type of broadcasting requires less network overhead, but receives no feedback from Helix Server. This broadcast method allows you to send a live stream to Helix Server version 9 or later. However, you must set up the server as a receiver in a splitting arrangement. Please refer to Helix Server documentation for details.
- **Push, Multicast (Helix Server)**
 - In a multicast, Encoder can deliver the same broadcast stream to any number of Helix Servers without increasing its outgoing bandwidth. The Helix Servers will need to be pre-configured for a multicast from the encoder. Refer to your Helix Server documentation for details.
- **Pull (Helix Server)**
 - In pull broadcasting, Encoder begins to generate broadcast packets as soon as you start the encoding. However, it does not deliver the broadcast stream until Helix Server requests the stream, which occurs when the first RealPlayer[®] user requests the broadcast. In that way, Pull broadcasting saves bandwidth between the encoder and Helix Server when no one is viewing the broadcast. This broadcast method allows you to send a stream to Helix Server version 9 or later.
- **Legacy Push (8.x, 7.x, G2)**
 - The legacy push method is similar to the account-based push method. However, the legacy push does not use a monitoring connection to provide server feedback and statistics and is not as robust a broadcast method as an account-based push. Use this broadcasting method only when sending a broadcast stream to a server that predates Helix Server version 9, such as RealSystem Server G2, 7, or 8.

Transport: When you use a push broadcast method, you specify whether to use UDP or TCP upon delivering the broadcast stream to Helix Server. UDP is the preferred protocol due to the lower network overhead. But you may want to use TCP when delivering the broadcast over a lossy environment.

Transport: UDP TCP

For the **Server Address field**, enter the IP address or DNS name of the Helix Server used for the broadcast, such as 207.188.7.176 or helixserver.example.com.

Server Address:

For the **Port/Port Range fields**, specify the HTTP port on Helix Server. The default value is port 80, which is the server's default HTTP port. If multicasting, indicate the range of ports on the Helix Server receivers where the broadcast packets will be sent. Encoder and Helix Server negotiate the actual ports to use once the broadcast begins. The default range is from 30001 to 30020.

Port/Port Range:

If using a **Multicast Address**, enter the multicast address for the broadcast stream in the **Multicast Address field**. The **Multicast Address** must be in the range 224.0.0.0 to 239.255.255.255.

Multicast Address:

In the **Stream Name field**, enter a name for the broadcast stream. This name resembles a clip name and should use the appropriate extension, either .rm for a constant bit rate stream or .rmvb for a variable bit rate stream. This name appears in the broadcast URL.

Stream Name :

The **Path (optional) field** specifies a virtual path, which can be used for archiving or splitting on Helix Server. Use a simple name followed by a forward slash, such as news/.

Path(optional):

In the **User name** and **Password fields**, enter the user name and password defined in each Helix Server receiver definition. The broadcast connection fails if the value is incorrect.

User Name:
Password:

The next series of fields activate the Real Encoder's filters to improve video and audio quality. These filter settings will depend upon the type of content that you are streaming and your subjective preference. It is recommended that you experiment with these settings and view their results on a test capture.

Video Quality:
Audio Content:
Video Noise Filter:
 De-Interlace filter
 Inverse Telecine

The encoder features integrated de-interlacing and inverse telecine filters that automatically apply when needed. This allows the encoder to perform at maximum efficiency. We recommend that you do not enable the Real Encoder de-interlace and inverse telecine filters since applying filters multiple times can produce undesirable results and consume additional system resources.

Advanced Streaming Settings

Audience Selection Enable SureStream

<input type="checkbox"/> 100% Quality Download (VBR)	<input type="checkbox"/> 5M Download (VBR)
<input type="checkbox"/> 128k Dual ISDN	<input type="checkbox"/> 5M Multichannel (VBR)
<input type="checkbox"/> 12k Substream for 28k Dial-up	<input type="checkbox"/> 5M Surround Stereo (VBR)
<input type="checkbox"/> 150k LAN	<input type="checkbox"/> 64k Single ISDN
<input type="checkbox"/> 16k Substream for 28k Dial-up	<input type="checkbox"/> 70% Quality Download (VBR)
<input type="checkbox"/> 1M Download (VBR)	<input type="checkbox"/> 750k Download (VBR)

Select all [Unselect all](#)

Enable SureStream™: SureStream allows you to encode the broadcast stream for multiple audiences. However, each primary stream or substream you choose increases the processor load during encoding and adds to the outgoing bandwidth requirements. For example, with SureStream enabled you can choose the 56k Dial-up audience and the 128k Dual ISDN audience. In addition, with SureStream enabled, the encoding might require twice as much processing power.

Regardless of whether or not you enable SureStream, you must choose at least one **Audience Selection** for your stream.

You can also choose to output to a file while streaming or output only to a file. Type in a unique name for the file.

Streaming to a File

Output to file

File Name:

D:\AVFiles\Out ... [default folder](#)

After you have input your settings, click the **Submit button** at the bottom of the page to save your changes.

Warning: If you click away to another Web page without first clicking **Submit**, your changes will be lost.



Windows Media Encoder Settings

Windows Media is both a storage format and a streaming format. In addition to the ability to output to a file, the Windows Media encoder can stream to a Windows Media Server. The settings for Windows Media encoder include the ability to set parameters for connecting and streaming to the server.

Encoder Properties

The screenshot displays the Windows Media Encoder configuration window. At the top, the name is set to 'QCIF_WM_50K' and the status is 'Stopped'. The interface is divided into several sections:

- Video Settings:** Includes checkboxes for 'Source' (checked), 'Input' (Composite), 'Signal' (NTSC_M), 'Proportions' (Standard), and 'Size' (CIF 320x240).
- Audio Settings:** Includes checkboxes for 'Source' (checked) and 'Input' (Unbalanced).
- Preset:** Set to 'None'.
- Streaming Properties:** Features a 'Windows Media Capture Profiles' dropdown menu (set to 'Windows Media 9 (50K) for Mobile Streaming'), 'Enable Pull' (checked) with 'Pull from Port' (7008), and 'Enable Push' (unchecked) with 'Push to Port' (80). It also has fields for 'Server', 'Alias', 'User Name', and 'Password', and an 'Enable Scripting' checkbox.
- Advanced Streaming Settings:** Contains 'SimulStream' (checked), 'Deinterlace' (Motion Adaptive), 'Motion Threshold' (Smooth, Value: 16), and 'Streaming to a File' (checked) with 'File Name' (D:\AVFiles\test.wmv) and 'Index the file' (checked).
- DRM Settings (Windows Media only):** Includes 'Enable DRM' (unchecked), 'Profile' (None), 'Description' (None), and 'Key' (N/A).

At the bottom, there are links for 'All Encoders', 'Delete Encoder', and 'Submit', along with a 'Bottom' link in the top right and a 'Top' link in the bottom right.

First select a Windows Media Capture Profile from the drop-down menu.

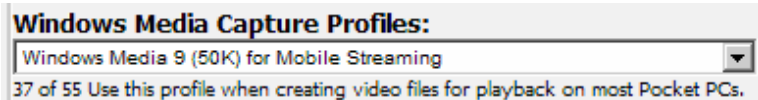

NOTE: Some *Windows Media Capture Profiles* have pre-defined video resolutions and input selections. When you select a *Windows Media Capture Profile*, verify that your current video and audio settings have not been modified. If they have been modified, simply change these settings back to their previous settings and click the **Submit button**.

When streaming audio and video, there are two methods of delivery, as follows:

- **Pull:** Using this method, the encoder begins to generate broadcast packets as soon as you start the encoding. However, it does not deliver the broadcast stream until Windows Media Server requests the stream. This method does not provide a secure connection to the server and should only be used if the encoder and server reside within the same network firewall.
- **Push:** Using this method, the encoder maintains a secure connection to Windows Media Server. This connection allows the encoder to pass a user name and password to authenticate access to the server.

To enable clients to pull the stream from the encoder, you set up a session and begin broadcasting directly from the encoder. Clients (Windows Media servers or players) can connect to the stream at any time by using the following URL format:

- `http://IP_address:port` (for Internet connections)
- `http://encoding_computer_name:port` (for LAN connections)

NOTE: The greater the number of direct connections to the encoder, the more system resources are required. We do not recommend having players connect directly to Encoder. Streaming servers should connect to the encoder and, in turn, players should connect to the servers.

Select the **Enable Pull** check box. Then, enter a port number that will be used by the server to pull the stream from Encoder.

NOTE: Be sure to enter a port number that is not already assigned to another encoder. If two encoders attempt to use the same port number, one or both encoders will fail to start.

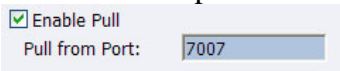

Select **Enable Push** and enter a port number that is not assigned to another encoder. Then, enter the server name or IP address, Alias (optional), user name, and password.

Enable Push

Push to Port:

Server :

Alias:

User Name:

Password:

You can also choose to output to file at the same time you are streaming to a server. However, you can set the server to archive the file and streaming, allowing the encoder to reserve its system resources for encoding. Refer to the Windows Media Server documentation for details.

Streaming to a file

Output to file Index the file

File Name:

... [default folder](#)

If you check **Index the file**, viewers will be able to direct access any point within the Windows Media® file using the Windows Media player. Indexing is also required for editing the Windows Media file using Microsoft Windows Media Utilities.

After you have input your settings, click the **Submit button** at the bottom of the page to save your changes.

Warning: If you click away to another Web page without first clicking **Submit**, your changes will be lost.



Niagara SCX Web Interface will then display the **All Encoders** list.

Encoders
This page allows you to perform encoder setup and removal.

Auto refresh page [Add Encoder](#)

GoStream Encoders | Total records : 8

Name	Description	Last Status	Streaming	Presets
Edit Del CIF_AVI	AVI Encoder Driver	OK	Stopped	
Edit Del CIF_F_350K	Flash Encoder	OK	Stopped	
Edit Del CIF_R_350K	Helix Producer Encoder	OK	Stopped	A
Edit Del CIF_R_768K	Helix Producer Encoder	OK	Stopped	
Edit Del CIF_W_350K	Windows Media Encoder	OK	Stopped	B
Edit Del CIF_W_768K	Windows Media Encoder	OK	Stopped	
Edit Del MOB_R_56K	Helix Producer Encoder	OK	Stopped	C

Deleting an Encoder Profile

You can also delete encoder profiles from the Cisco Digital Media 1000. It is valuable to remove encoders you will not use, as every encoder profile, regardless if active or idle, uses active memory.

NOTE: Once you delete a custom profile, you cannot restore it. It must be recreated.

NOTE: If you delete a default encoder profile, you can restore it by using the **Restore to Factory Settings** function.

NOTE: Running the **Restore to Factory Settings** will remove any custom encoder profiles you have created and load only the default encoder profiles.

To delete an encoder profile, you must access the **All Encoders** list in the **Niagara SCX Web Interface**.

Encoders
This page allows you to perform encoder setup and removal.

Auto refresh page [Add Encoder](#)

GoStream Encoders | Total records : 9

Name	Description	Last Status	Streaming	Preset
Edit Del CIF_AVI	AVI Encoder Driver	OK	Stopped	B
Edit Del CIF_FLV_512K	Flash Encoder	OK	Stopped	
Edit Del CIF_RV_512K	Helix Producer Encoder	OK	Stopped	
Edit Del CIF_WM_500K	Windows Media Encoder	OK	Stopped	
Edit Del QCIF_RV_56K	Helix Producer Encoder	OK	Stopped	C
Edit Del QCIF_WM_50K	Windows Media Encoder	OK	Stopped	A
Edit Del REAL BBC 256	Helix Producer Encoder	OK	Stopped	
Edit Del REAL BBC 56	Helix Producer Encoder	OK	Stopped	
Edit Del WME	Windows Media Encoder	OK	Stopped	

You can delete an encoder by clicking the **Del link** next to the encoder you wish to remove.

GoStream Encoders | Total records : 5

Name	Description	Last Status
Edit Del FLASH ENCODER	Flash Encoder	OK
Edit Del MPEG4 ENCODER	MPEG4 Encoder Driver	OK
Edit Del QCIF_RV_56K	Helix Producer Encoder	OK

Alternatively, you can click the **Edit link** to view the encoder profile, verify that it is the encoder that you wish to remove.

GoStream Encoders | Total records : 5

Name	Description	Last Status
Edit Del FLASH ENCODER	Flash Encoder	OK
Edit Del MPEG4 ENCODER	MPEG4 Encoder Driver	OK
Edit Del QCIF_RV_56K	Helix Producer Encoder	OK

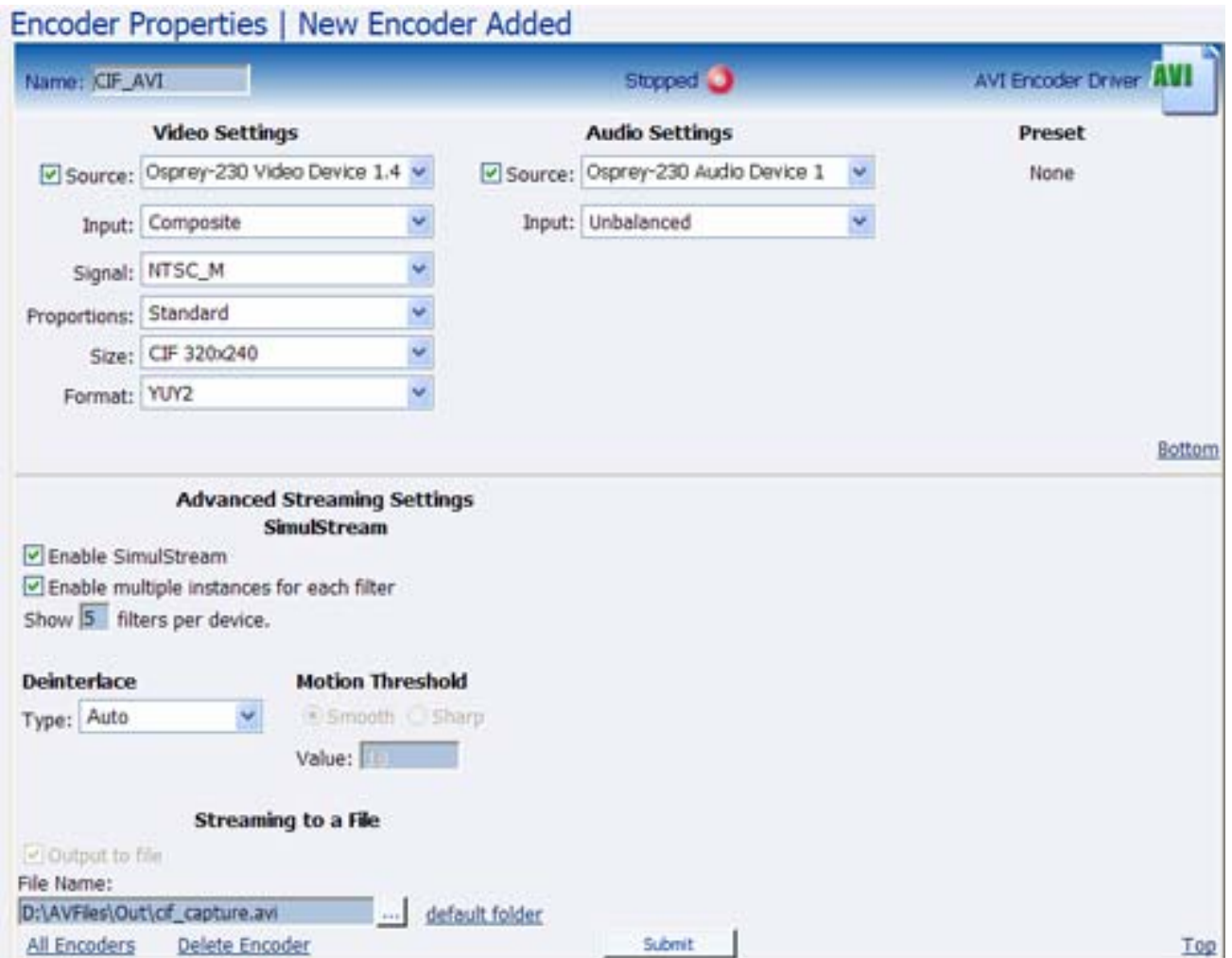

Then click the **Delete Encoder link** at the bottom of the page once you have verified that it is the encoder you want to delete.



My Encoder



The *My Encoder page* provides details on software versions, network name, serial number, and hard drive configurations. Most of the data on this page is for informational purposes and cannot be altered. However there are two fields that allow modifications. They are as follows:

- Computer Name
- Admin password

Computer Name

The *Computer Name field* contains the current network name for the Cisco Digital Media 1000. This is the same name that you typed into a Web browser to access the *Niagara SCX Web Interface*. You can change the Computer Name by clicking the *Click to change name link* next to this field.

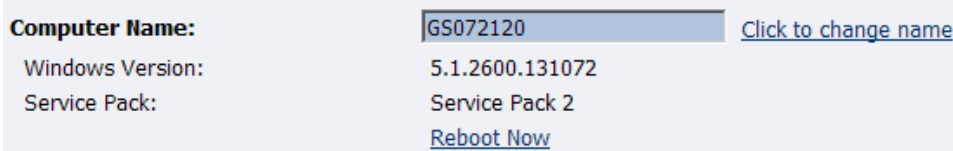

The screen will refresh and now the *Computer Name field* is an editable text field. Type in a new name for the encoder.

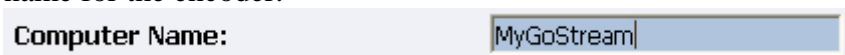

Then click the **Submit button** at the bottom of the page.



Note: Changing the computer name will require the system to be rebooted.

The page will refresh and you will be prompted to reboot the encoder. Your changes will not take effect until the system is restarted.

Click the **Reboot Now link** to restart the system and apply the Computer Name change.

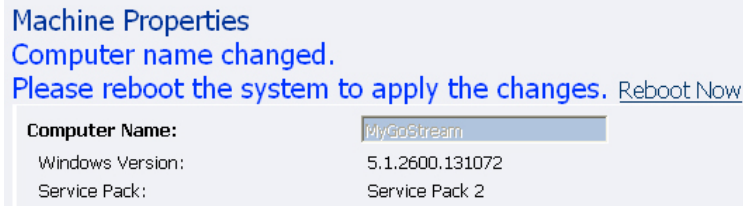

While the encoder is restarting, the following message will appear in the Web Interface.

The Web service is currently not available. Please wait for the service to be restarted and returned to normal service. This page will automatically refresh.

In Progress... System Reboot **Friday, September 5, 2007, 6:00:42 p.m.**

NOTE: The restart process takes approximately two minutes to complete.

When the encoder has restarted, you will be returned to the **Login screen**.

NOTE: If you close your Web browser and later want to log into the **SCX Web Interface**, you will need to use the new computer name you created to access the encoder.

Cisco Digital Media 1000 Properties

The **Encoder Properties section** has two fields; **User Name** and **Serial Number**. Only the **User Name field** allows modification, which changes the **User Password** from the factory default.

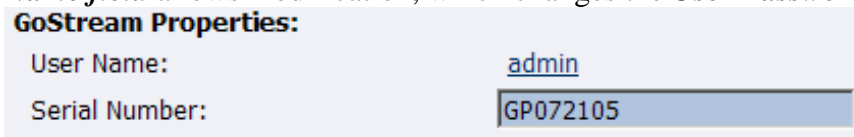

Changing the Login Password from the Factory Default

Click the **admin link** in the **User Name field**. You will be presented with a new screen that allows you to change your login password for the **SCX Web Interface**.

NOTE: You cannot change the **User Name** for the SCX Web Interface.

Type in your current password in the *Password field* and then type in the new password in both the *New Password* and *Confirm New Password fields*.

NOTE: The *SCX Web Interface password* is case sensitive.

Change your password for the GoStream web login.



Change Your Password

User Name:

Password:

New Password:

Confirm New Password:

[Back to home page](#)

Then click the *Change Password button*. You will then be presented with the results, which are shown below.

Change your password for the GoStream web login.

[Password Changed successfully, click to login](#)

NOTE: You will need to log back into the Web Interface with your new password.

Restoring the Login Password to the Factory Default

If you have forgotten or lost your password, you can restore the default password by running the *Restore Encoder Factory Defaults option*. For more information, see *Restore Encoder Factory Defaults* in the *System Configuration section* in the following sections.

Cisco Digital Media 1000 Alerts

The representation below provides you with a representation of a page that allows you to control how the encoder handles application alerts that may occur during streaming or other operations. The encoder can optionally send an email to multiple recipients and light the alarm light on the front panel of the encoder.

Alerts
This page allows you to control how GoStream handles application alerts that may occur during streaming or normal operations. GoStream can optionally send a single email or close a hardware contact on the dual dock for each condition selected below. Click to see the GoStream [Email address](#).

GoStream Alerts | records : 10

	Send Email	Light Alarm	Close Contact	Displayed Text	Description
Edit	<input type="checkbox"/>	<input checked="" type="checkbox"/>	<input type="checkbox"/>	Exception	
Edit	<input type="checkbox"/>	<input checked="" type="checkbox"/>	<input type="checkbox"/>	Encoder Error	
Edit	<input type="checkbox"/>	<input checked="" type="checkbox"/>	<input type="checkbox"/>	Undefined	
Edit	<input type="checkbox"/>	<input type="checkbox"/>	<input type="checkbox"/>	Encoder Started	
Edit	<input type="checkbox"/>	<input type="checkbox"/>	<input type="checkbox"/>	Encoder Stopped	
Edit	<input type="checkbox"/>	<input checked="" type="checkbox"/>	<input type="checkbox"/>	AlarmTest	
Edit	<input type="checkbox"/>	<input checked="" type="checkbox"/>	<input type="checkbox"/>	SCX service stopped	
Edit	<input type="checkbox"/>	<input type="checkbox"/>	<input type="checkbox"/>	SCX service started	
Edit	<input type="checkbox"/>	<input type="checkbox"/>	<input type="checkbox"/>	Warning	
Edit	<input type="checkbox"/>	<input checked="" type="checkbox"/>	<input type="checkbox"/>	High Temperature!	

Email Alert

You can optionally send an email alert to specific email address in the event of an application alarm. Checking **Send Email** will enable this feature. You must specify the email address to which an alert will be sent, along with your email server user name, password, and server name. For more information about configuring the encoder to send email alerts, see the **System Configuration section** in the following sections.

Alarm Light

Checking the **Light Alarm box** will instruct the encoder to light the front panel alarm light.

Edit Alert Settings

To edit the settings for each alert listed, click the **Edit link** in the row of the alert you want to modify.

Once you have made your modifications to the **alert settings**, click the **Update link** to enter your settings and return to the **encoder Alerts list**.

GoStream Alerts | records : 10

	Send Email	Light Alarm	Close Contact	Displayed Text	Description
Edit	<input type="checkbox"/>	<input checked="" type="checkbox"/>	<input type="checkbox"/>	Exception	
Update Cancel	<input type="checkbox"/>	<input checked="" type="checkbox"/>	<input type="checkbox"/>	Encoder Error	

View Alerts

All alerts defined on the *encoder Alerts page* are logged on the *View Alerts page* when those alerts occur. Once a user has cleared an alert using the *Help, or “i,” button* on the front panel of the encoder, the alert is cleared from the *View Alerts log page*.

Alerts | No GoStream alerts at this time.

Alternatively, the encoder system informs you of an alert when the *Alarm Indicator Light* on the front panel of the system turns red. When this occurs, to determine what the alert is, you must press the *Help, or “i,” button*, which will cycle the alert occurring.

Please see the *The Help, or “i,” button, the Niagara SCX Web Interface, and their Alert Settings section* set forth later in this document.

Network Properties

The *Network Properties page* provides detailed information on the encoder’s current network settings for the Network Interface Card (NIC). In the example below, the *Advanced Settings* on the *Primary WINS Server* and the *Secondary Wins Server* appear due to the encoder system running on Windows® servers.

Home Encoders Configuration Status Log Out

(TCP/IP) Network Properties

Network Card(s) Primary NIC
Description: Intel(R) PRO/100 VE Network Connection - Packet Scheduler Miniport

Obtain an IP address automatically
 Use the following IP information

IP Address: 172.16.1.127
Subnet Mask: 255.255.255.0
Default Gateway: 172.16.1.251
Preferred DNS Server: 172.16.1.3
Alternate DNS Server: 172.16.2.3

Advanced Settings on GP072105
MAC Address: 00:60:E0:04:D8:46
Primary WINS Server: 172.16.1.5
Secondary WINS Server: 172.16.1.12
Active Network Link: 

Submit Reset

Should the encoder system not be running on Windows servers, the screenshot below, or a similar screenshot, appears.

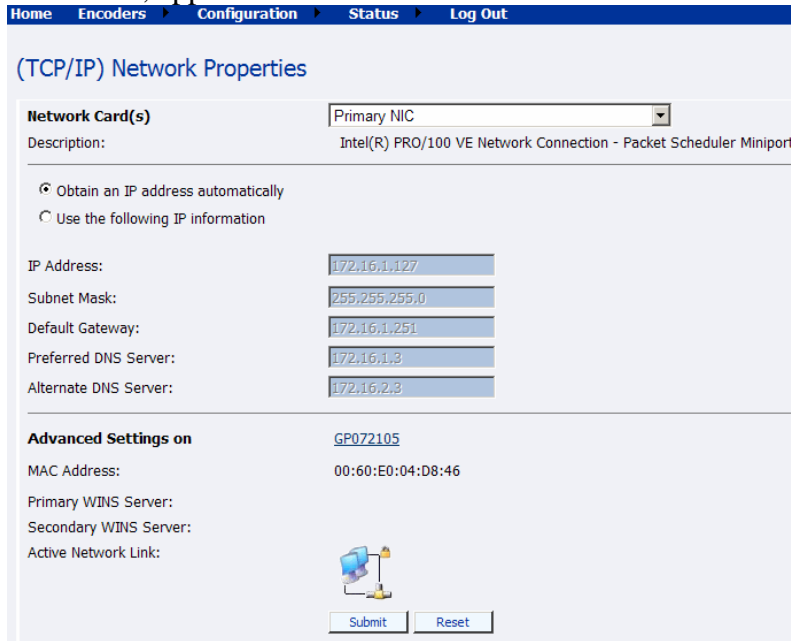

If the following screenshot appears, please note no Ethernet cable is attached from the encoder system into a server. Note the statement **Verify the network cable to enable network setting updates!** and the icon at the bottom of the screen indicating a disconnect.

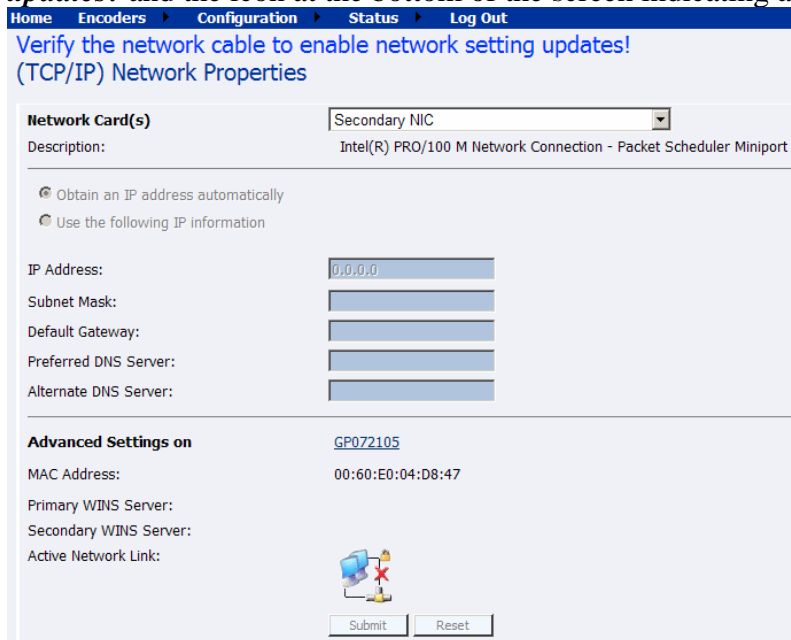

Network Card(s)

The encoder has two network connections: a primary connection and a secondary connection. To view the current properties for each card, select the card you wish to view from the drop-down menu in the *Network Card(s) field*.

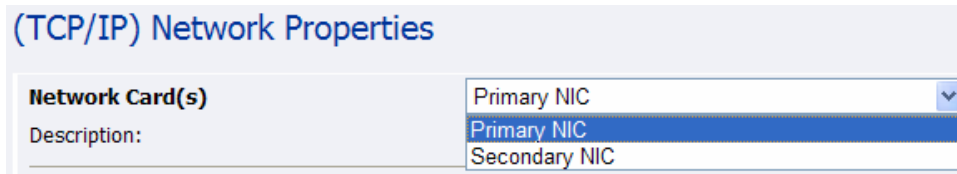

(TCP/IP) Network Properties

Network Card(s): Primary NIC
Description: Primary NIC
Secondary NIC

Advanced Settings (Network)

Advanced Settings provides the encoder network name, MAC Address and server IP address settings.



Advanced Settings on [GP072105](#)

MAC Address: 00:60:E0:04:D8:46

Primary WINS Server: 172.16.1.5



Secondary WINS Server: 172.16.1.12

Active Network Link: 

Submit Reset

The encoder network name is a link. If you click this link, you will be directed to the *My encoder page*. From this page you can change the encoder's network name. For more information, see the preceding section entitled *Computer Name*.

The *Active Network Link field* uses two icons to indicate whether the network interface card selected has a network connected.

Network Link Icon	Description
	The network link is detected.
	The network link is not detected.

System Configuration Settings

The *System Configuration Settings page* allows you to modify your encoder default system settings. You can configure email settings so that encoder can send an email to predefined email addresses whenever encoder encounters an alert condition. You can also customize the information that encoder displays on its front panel when the system is idle.

This page also provides the ability to restore your encoder to its original factory disk image returning all of the system settings to their original state. Using the *Factory Restore option* will remove all custom settings and takes approximately 10 minutes to complete.

Home Encoders Configuration Status Log Out

This page allows you to modify your GoStream default system settings.

Enter a valid email settings to have GoStream send emails for [alert conditions](#). Optionally select the information to show on the GoStream display when GoStream is idle. You can customize the idle screen text or use the default settings. [Restore GoStream Factory Defaults](#)

System Configuration Settings

Email Settings:

Send Emails To:

Email From:

Subject:

SMTP (Mail) Settings:

User Name:

Password:

SMTP Host: [Save and Send Test Email](#)

Idle Screen Information:

Cycle this information in the display when GoStream is idle.

Active IP Computer Name CPU
 Memory Hard Drive Temperature

Idle screen text:
Note: Each line in the display is 20 characters.

Line 1
 Line 2
 Line 3
 Line 4

*Default AV Folder:

High Temperature Alert: degrees Celsius. (view [Alert Configuration](#))

Restore Cisco Digital Media 1000 Factory Defaults

Click the *Restore Gostream Factory Defaults link* to start the process.

: the information to show on the GoStream display.

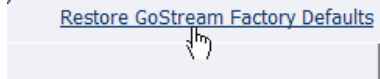

The screen below provides details, as you would be provided, as to the process you are about to execute, and allows you the opportunity to cancel the process.

Restore Factory Defaults

Restore to factory Defaults allows the rebuilding of the GoStream primary disk drive (C:) to be set to the original system defaults. This reconfigures the system and all files on the primary disk will be removed and the factory image reinstalled.

This option should only be selected if you are experiencing significant difficulties with your system or you wish to return to the factory defaults. Selecting this process will stop all running programs and take approximately 10 minutes to complete.

Do not power off or interrupt the system restore once started. A message on the GoStream LCD display will be left on the screen while the restoring executes and removed when finished. All services will automatically restart and allow you to set your personal settings with the menu or with this Web site when completed.

Continue with restoring the entire system back to Factory Defaults ?

Yes [Restore my system](#) back to the factory defaults or No, take me back to the [Home Page](#)

NOTE: Restore to Factory Defaults rebuilds the encoder primary disk drive (C:) with the original system image. All custom settings and any files saved to drive C: will be lost. This process cannot be reversed. However, you can manually re-enter your custom settings once the encoder restore process is completed.

NOTE: The default directory for saving your audio and video files is D:\AV Files\. When using the **Restore to Factory Defaults option**, only drive C: is re-imaged. All files and folders on drive D: are preserved. To ensure your personal files are not removed, always use the default directory – drive D – for storage of personal files.

Email Settings

If you are unfamiliar with setting up an SMTP email account for sending email, please contact your network administrator for assistance.

To configure **0 email settings**, you will need to enter the following information:

- The address to which to send the email (separate multiple email address with a comma)
- A valid email address from which the email comes
- A subject line for your email alert – required
- The SMTP (mail server) settings
 - User name for server access
 - Password (if required)
 - The name of the SMTP server

The screenshot shows a web interface for configuring system settings. At the top, there is a navigation bar with links for Home, Encoders, Configuration, Status, and Log Out. Below the navigation bar, a message states: "This page allows you to modify your GoStream default system settings." The main content area is titled "System Configuration Settings" and includes a link to "Restore GoStream Factory Defaults". Under the "Email Settings:" section, there are three input fields: "Send Emails To:", "Email From:", and "Subject:". The "Subject:" field contains the text "System Status Report on GP072105". Below the "Email Settings:" section is the "SMTP (Mail) Settings:" section, which includes three input fields: "User Name:", "Password:", and "SMTP Host:". A "Save and Send Test Email" button is located at the bottom right of the form.

NOTE: For security purposes, the *password for your account* will not be displayed once it has been entered into the *encoder settings*. However, although this field appears blank after you click the *Submit button*, the password information has been retained.

NOTE: If you change any information in this dialogue box, you will need to re-enter your SMTP password before clicking the *Submit button*. Not doing so will overwrite the previously entered password with a blank entry.

Once you have entered the information above, click the *Submit button* to save your changes. Please see the screenshot directly below.



You can test your settings by clicking the *Save and Send Test Email link*. The resulting page will report if the email was successfully sent or there was a send failure.

SMTP (Mail) Settings:

User Name:	<input type="text"/>	
Password:	<input type="password"/>	
SMTP Host:	<input type="text"/>	Save and Send Test Email

Idle Screen Information

This section allows you to modify the information that is displayed in the encoder LCD display on its front panel.

Check the boxes next to the information you wish to be displayed. This information is cycled as the LCD display alternates between status information and encoder information.

At the top of the LCD idle screen is the default message *System is Ready*. You can customize this message.

Idle Screen Information:

Cycle this information in the display when GoStream is idle.	<input checked="" type="checkbox"/> Active IP	<input checked="" type="checkbox"/> Computer Name	<input checked="" type="checkbox"/> CPU
	<input checked="" type="checkbox"/> Memory	<input checked="" type="checkbox"/> Hard Drive	<input checked="" type="checkbox"/> Temperature
Idle screen text: <small>Note: Each line in the display is 20 characters.</small>	<input type="text" value="GoStream is Ready"/>	Line 1	
	<input type="text"/>	Line 2	
	<input type="text"/>	Line 3	
	<input type="text"/>	Line 4	

Once you have entered the information above, click the *Submit button* to save your changes.



Default Directory Setting

NOTE: We strongly recommend that you do not alter the default directory setting unless you understand the risk of saving your files to a directory not located on drive D. If you save your files to another drive on the encoder, these files could be deleted if you use the **Restore to encoder Factory Defaults** feature.

NOTE: Only drive D on the encoder has available storage to save your files. This drive has approximately 30 Gigabytes of storage capacity.

NOTE: Drives C, E, and F are used strictly for encoder operational programs. Any modifications to these drives can permanently damage your system and void your warranty.

The Default AV Folder is the directory that the encoder stores AV files created whenever you select the **Save to File** option in an encoder profile. Refer to the **Save to File** option under the **AVI, Flash[®], Real, and Windows Media Encoder Properties** sections for information on setting an encoder profile to create an AV file.

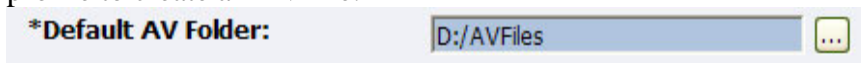

High Temperature Alert

You can enable an alert if the encoder reaches a predefined maximum temperature level. To set the level, select the drop-down menu.







The **Alert Configuration** links to the **encoder Alerts** page. Refer to the previous sections for information on setting the encoder Alerts.



EASE MENU (LCD DISPLAY)

This section provides the detail of the LCD menu tree. It is intended to be a complete reference to all levels and functions accessible using the encoder front panel LCD display.

It is designed to be a visual reference of the LCD screen including the front panel button action to move to the next screen. This section will utilize these graphical icons for the various button actions:

- Power On 
- Access Menu/Return to Previous 
- Enter/Execute Command 
- Move Pointer Up/Down 
- Start Encoder 
- Stop Encoder 
- Load Encoder 

Encode Menu

Encode Start

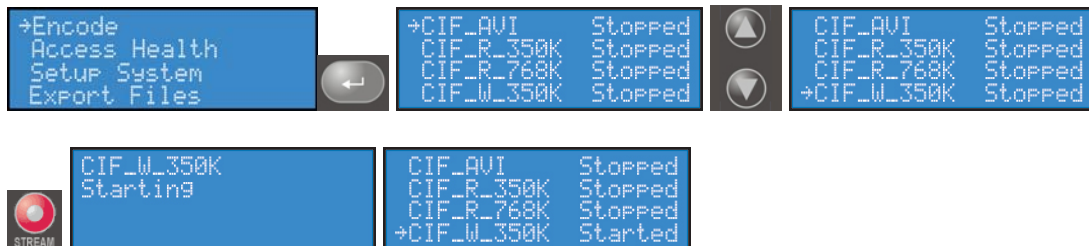

Encode Stop

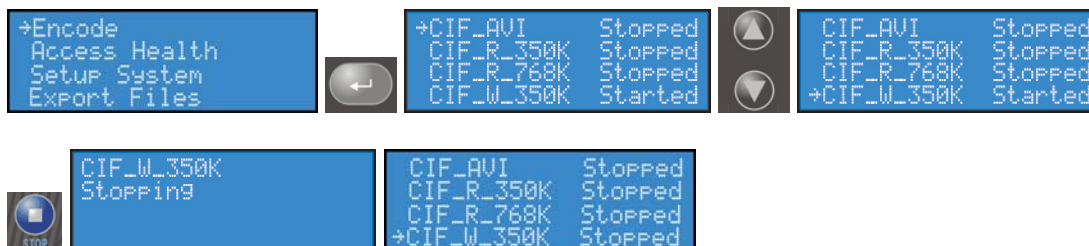

Encode Status

→Encode Access Health Setup System Export Files	→CIF_AVI Stopped CIF_R_350K Stopped CIF_R_768K Stopped CIF_W_350K Stopped	↑ ↓	CIF_AVI Stopped CIF_R_350K Stopped CIF_R_768K Stopped →CIF_W_350K Stopped
--	--	--------	--

CIF_W_350K AVI Encoder Driver Preset: Not Assigned State: Stopped
--

Access Health Menu

CPU Status

Encode →Access Health Setup System Export Files	→CPU Memory Temperature	CPU in use 48% PRESS ENTER
--	-------------------------------	--------------------------------------

→CPU Memory Temperature	→Encode Access Health Setup System Export Files
-------------------------------	--

Memory Available

Encode →Access Health Setup System Export Files	→CPU Memory Temperature	CPU →Memory Temperature
--	-------------------------------	-------------------------------

Available Memory Harddrive: 92.77% RAM: 308.00 MB PRESS ENTER	CPU →Memory Temperature	→Encode Access Health Setup System Export Files
--	-------------------------------	--

Temperature Status

→Encode Access Health Setup System Export Files	→CPU Memory Temperature	CPU Memory →Temperature
--	-------------------------------	-------------------------------

Current Temperature 39.75 C PRESS ENTER	→CPU Memory Temperature	→Encode Access Health Setup System Export Files
---	-------------------------------	--

Setup System Menu

Network Link Status

Encode Access Health →Setup System Export Files	→Network Time & Date Temperature Alarm Factory Restore	→Primary NIC Secondary NIC
--	---	-------------------------------



Network MAC Address



View Network Settings





Enable DHCP

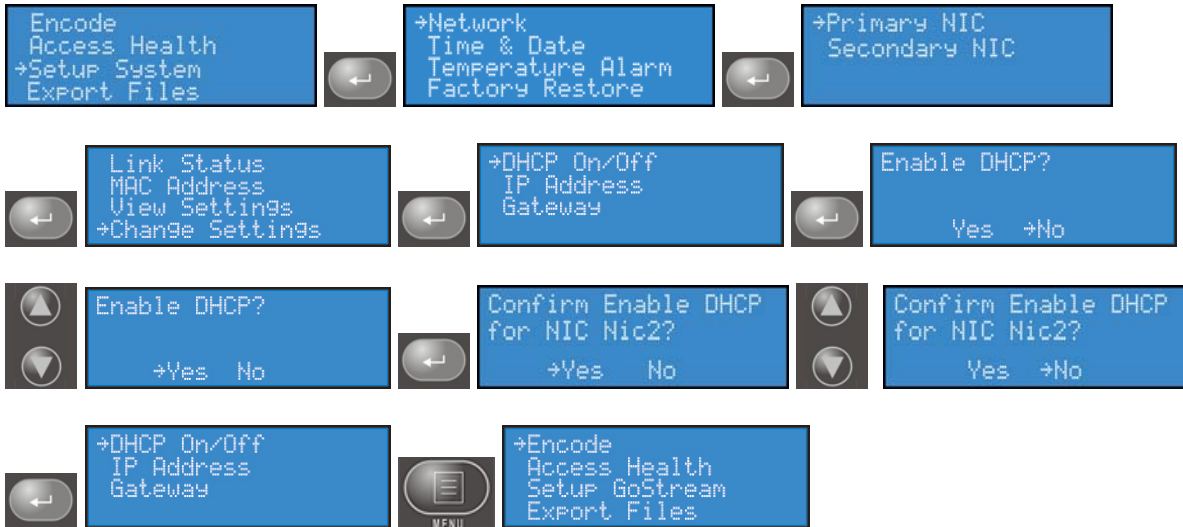



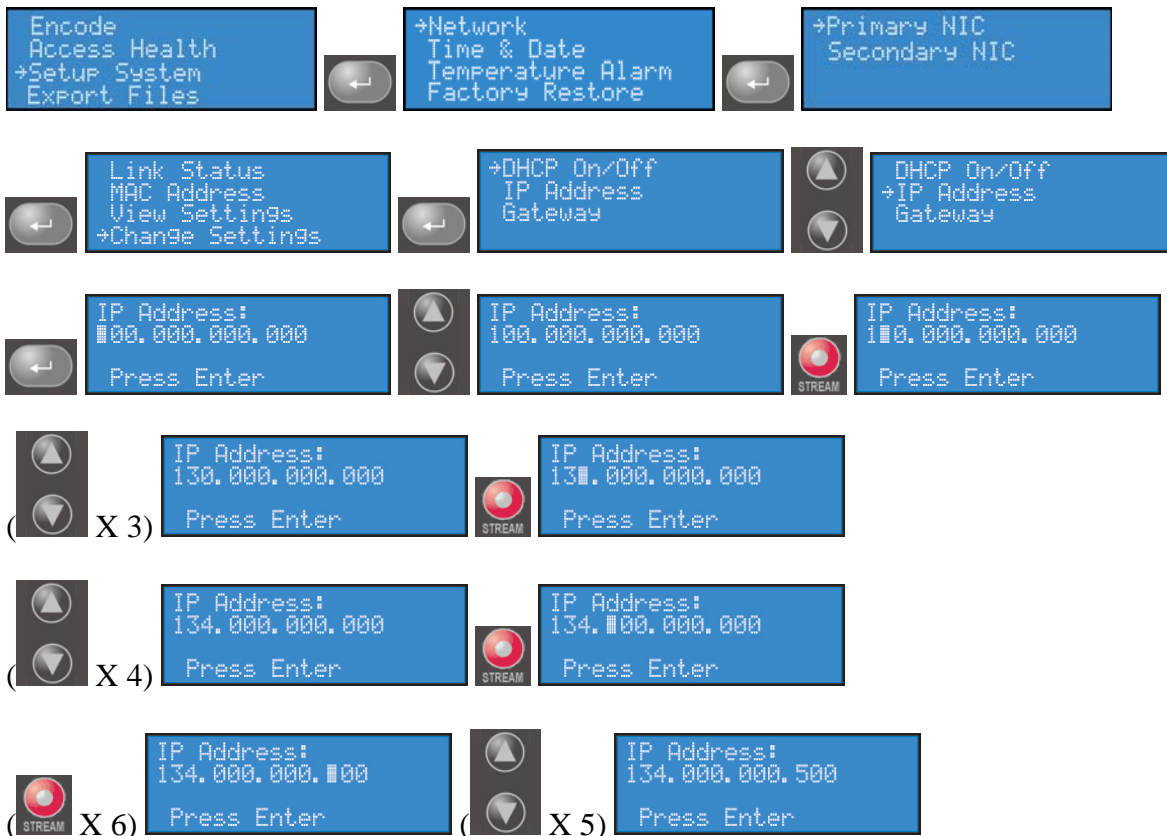

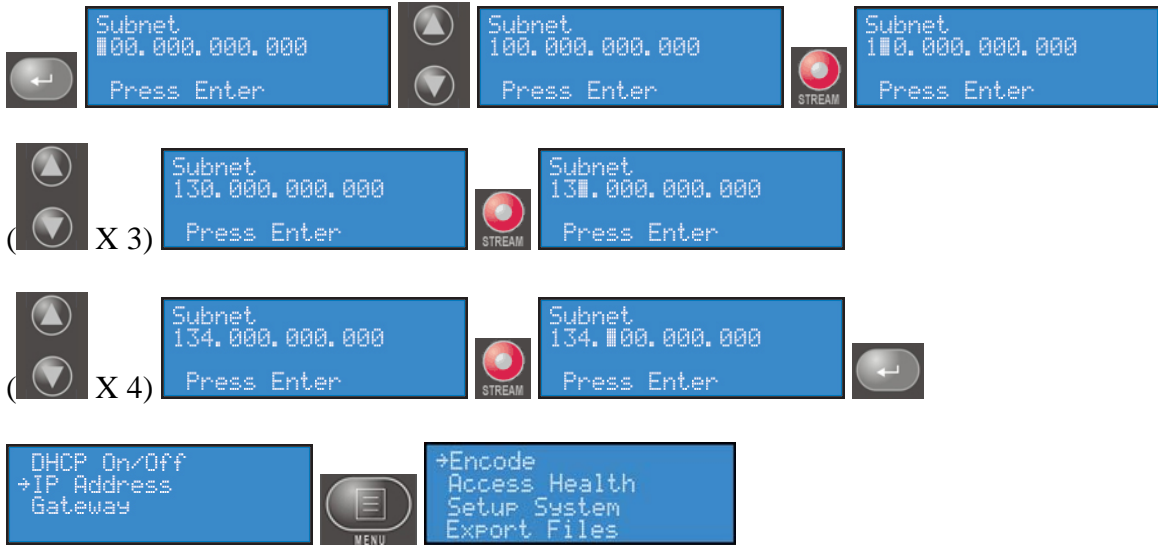

Set Static IP Addresses











Set Gateway Address



Gateway Address: 255.255.000.000 Press Enter	(↑ ↓ X 5)	Gateway Address: 255.255.000.000 Press Enter	
Gateway Address: 255.255.000.000 Press Enter	(↑ ↓ X 2)	Gateway Address: 255.255.200.000 Press Enter	
Gateway Address: 255.255.200.000 Press Enter	(↑ ↓ X 5)	Gateway Address: 255.255.250.000 Press Enter	
Gateway Address: 255.255.250.000 Press Enter	(↑ ↓ X 5)	Gateway Address: 255.255.255.000 Press Enter	
		Gateway Address: 255.255.255.000 Press Enter	
DHCP On/Off IP Address →Gateway		→Encode Access Health Setup System Export Files	

Set Date & Time

Encode Access Health →Setup System Export Files		→Network Time & Date Temperature Alarm Factory Restore	(↑ ↓)	Network →Time & Date Temperature Alarm Factory Restore	
→Date Time					
Enter Date MM-DD-YYYY 00-10-2006 Enter to Accept	(↑ ↓ X 5)	Enter Date MM-DD-YYYY 11-10-2006 Enter to Accept			
Enter Date MM-DD-YYYY 11-10-2006 Enter to Accept	(↑ ↓ X 15)	Enter Date MM-DD-YYYY 11-25-2006 Enter to Accept			
Enter Date MM-DD-YYYY 11-25-2006 Enter to Accept	(↑ ↓ X 2)	Enter Date MM-DD-YYYY 11-25-2008 Enter to Accept			
→Date Time	(↑ ↓)	Date →Time			

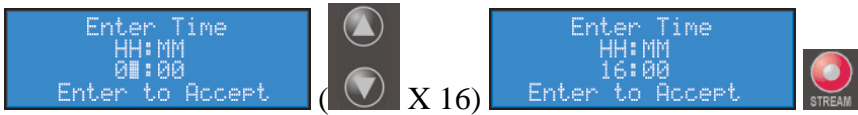

Setting Temperature Alarm

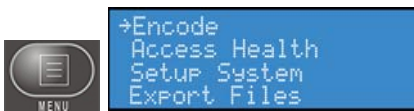
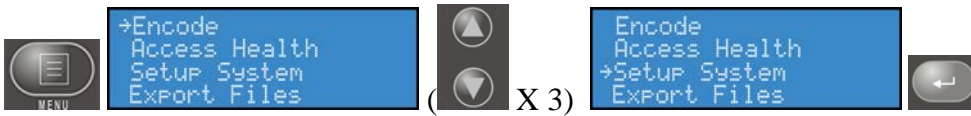

Factory Restore

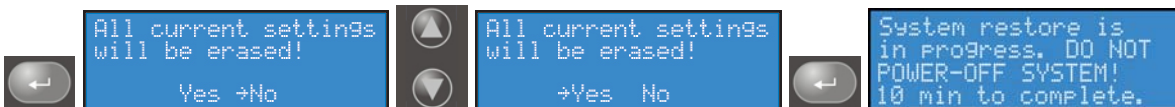
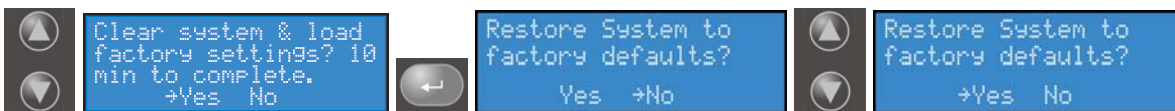
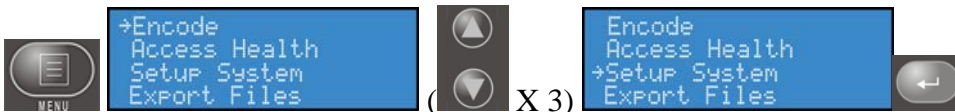

<10-minute delay>

Welcome to setup:
Set time, date, and
video format.
PRESS ENTER ...



Enter Date
MM-DD-YYYY
00-10-2006
Enter to Accept



X 5)

Enter Date
MM-DD-YYYY
11-10-2006
Enter to Accept



Enter Date
MM-DD-YYYY
11-10-2006
Enter to Accept



X 15)

Enter Date
MM-DD-YYYY
11-25-2006
Enter to Accept



Enter Date
MM-DD-YYYY
11-25-2006
Enter to Accept



X 2)

Enter Date
MM-DD-YYYY
11-25-2008
Enter to Accept



Enter Time
HH:MM
00:00
Enter to Accept



X 16)

Enter Time
HH:MM
16:00
Enter to Accept



Enter Time
HH:MM
16:00
Enter to Accept



X 25)

Enter Time
HH:MM
16:25
Enter to Accept



Select the video
format to use for
all encoders
PRESS ENTER ...



→NTSC
PAL



First time setup is
completed.
PRESS ENTER ...



Export Files Menu

Export to USB Drive

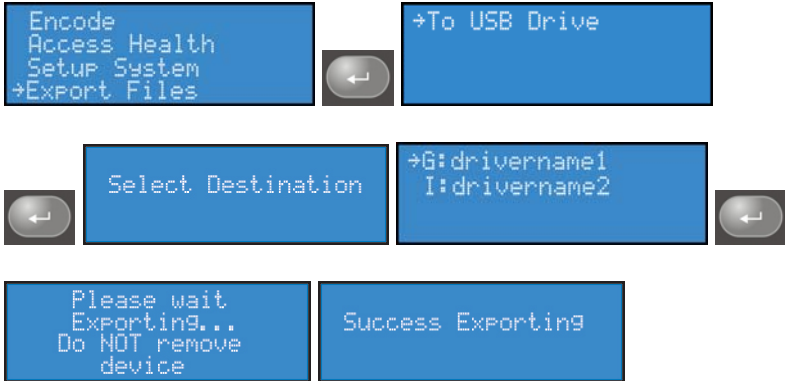

Shutdown Encoder

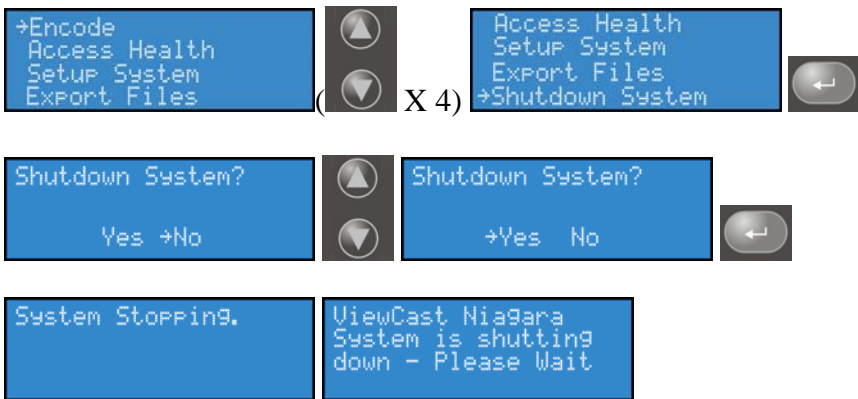

NIAGARA SCX WEB INTERFACE

The Cisco Digital Media 1000 includes the *Niagara SCX Web Interface*, which allows you to access the advanced system settings. The *Web Interface* also provides detailed settings and control over the encoder profiles installed on the encoder. This section details each setting and page of the *Niagara SCX Web Interface*.

Log In

The *Niagara SCX Web Interface* does not require software and works with any computer that has a current Web Browser and current operating software for Windows™, Macintosh™, and Linux™ machines. The encoder system must either reside on a shared IP network with the computer or can be directly connected to a Windows computer using an Ethernet cable (RJ45).

Open the Web browser on your computer and access the *Web Interface* by typing in the encoder network name. The network name of the encoder is also its serial number and can be obtained from the LCD readout during the power-up process.

The serial number is also located on the bottom of the encoder.

Enter the encoder name in the Web Browser, as shown below, and press *enter*.

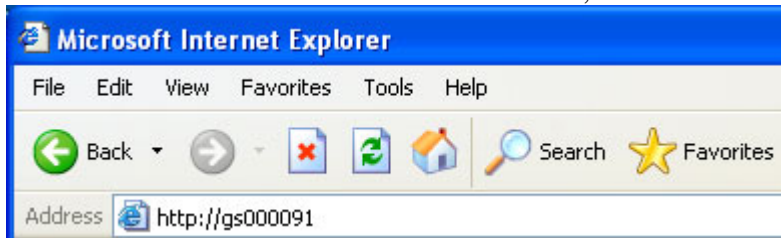

You will be prompted with a login screen requiring a *user name* and *password*.

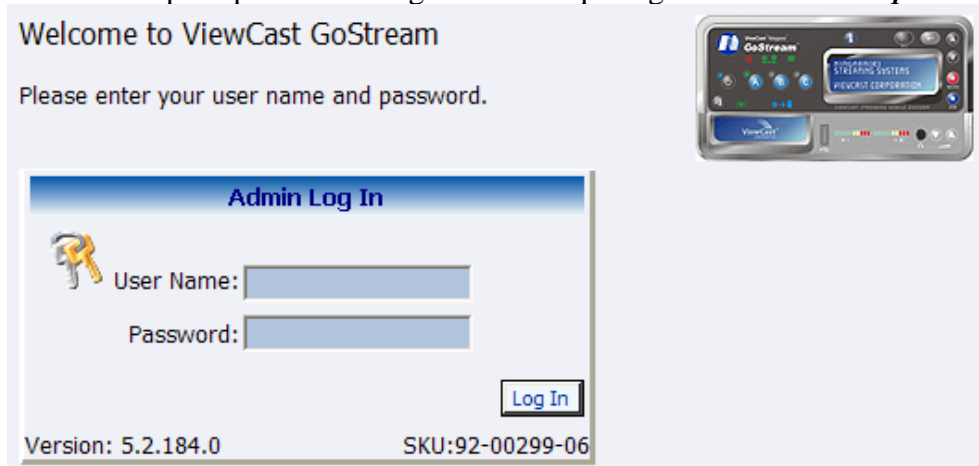

By default, the *user name* and *password* are *admin*.

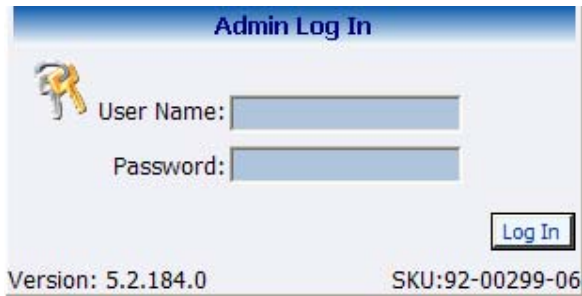

NOTE: If you cannot browse to the encoder using its machine name, type in the encoder IP address instead. This information is available by accessing the LCD menus on the front panel of encoder.

Home Page

The **Home Page** is the first page presented after you log into the **Niagara SCX Web Interface**. From this page, you can access the different pages for configuring, controlling, and monitoring the activities and alerts from encoder.



Menu Bar

The menu bar at the top of the **Home Page** is consistent and available throughout the Website.

With the exception of the **Home** and **Log Out** menu options in the menu bar at the top of the **Home Page**, the other options in the menu bar have drop-down menus. These drop-down menus appear within **Encoders**, **Configuration**, and **Status**. Each drop-down menu provides a list of additional options available.

Home

The **Home** title is an active link. Clicking this link will direct you to the **Home Page** of the **Website**.

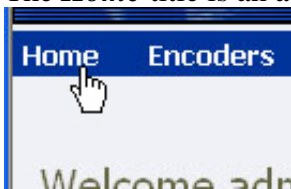

Encoders

The **Encoders** drop-down menu provides access to the following Web pages that provide the following information:

- **All Encoders** – Lists all of the encoding profiles loaded on the encoder and provides management of those profiles
- **Preset A** – Allows you to assign a loaded encoding profile to the **A button** on the front panel of the encoder
- **Preset B** – Allows you to assign a loaded encoding profile to the **B button** on the front panel of the encoder
- **Preset C** – Allows you to assign a loaded encoding profile to the **C button** on the front panel of the encoder

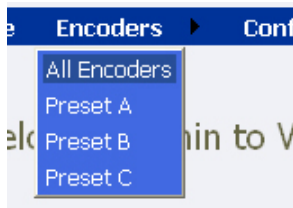

Configuration

The **Configuration** drop-down menu provides access to the following:

- **My encoder** – Provides details on the **Machine Properties** of the encoder including the Network Name, Serial Number, and all software versions installed
- **encoder Alerts** – Allows modification of the settings for each application alert that encoder could generate during normal operations
- **Network Properties** – Provides information on encoder network properties and addresses for both NIC ports and allows modification to these properties
- **System Configuration** – Allows modification of the system configuration including setup for email alerts from encoder whenever it encounters an operation error

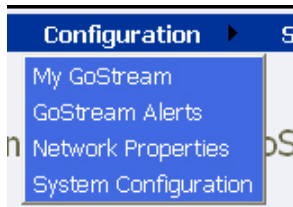

Status

The *Status* drop-down menu provides access to the following:

- **View Activity Log** – A list of all encoder activities with date and timestamp on each event
- **View Alert** – A list of encoder alerts with date and timestamp on each alert

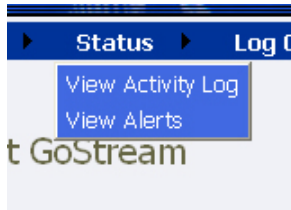

Log Out

The *Log Out option* executes user log out from the encoder and returns you to the *Website Log In screen*.



All Encoders

The *All Encoders Web page* provides a list of all of the encoder profiles loaded on the encoder. On this page, you can do the following:

- **View** all of the loaded and available encoder profiles
- **Start** and **Stop** each encoder individually
- **Access** the *Editing page* for an encoder
- **Delete** an encoder profile
- **Create** an encoder profile

Encoders				
This page allows you to perform encoder setup and removal.				
<input type="checkbox"/> Auto refresh page				Add Encoder
NiagaraPro Encoders Total records : 7				
Name	Description	Last Status	Streaming	Preset
Edit Del Flash	Flash Encoder	Encoder stopped	Stopped	
Edit Del Full AVI	AVI Encoder Driver	OK	Stopped	
Edit Del Full_Real_1Mb	Helix Producer Encoder	OK	Stopped	
Edit Del Full_WM_2Mb	Windows Media Encoder	OK	Stopped	
Edit Del WME	Windows Media Encoder	Encoder started	Started	
Edit Del WME2	Windows Media Encoder	Encoder stopped	Stopped	
Edit Del wme3	Windows Media Encoder	Stopped	Stopped	

The **Encoders** list has five titled columns, as follows:

- **Name** – Provides the name of the encoder profile (this name is displayed in the encoder front panel LCD display)
- **Description** – Defines the type of encoder which are AVI, Flash, Helix Producer, and Windows Media
- **Last Status** – Provides the activity of the encoder when the information on this page was last refreshed (for example, **Encoder started** or **Encoder failed to start**)
- **Streaming** – Provides a column of buttons that allow you to start or stop an encoder
- **Preset** – Provides information on the **EZStream button** assignment for each encoder (if this field is blank then the encoder is not assigned to a **EZStream button**)

Enabling the **Auto Refresh Page check box** at the top of the page will execute a refresh of this page every 10 seconds. This is useful when you are monitoring the encoder while another user is operating it.

Auto refresh page

Start Encoder

Press the red **Stream icon** located in the right column of the encoder you wish to start.

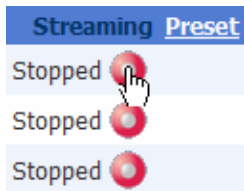

The Web page will automatically update with messages detailing the encoder start progress.

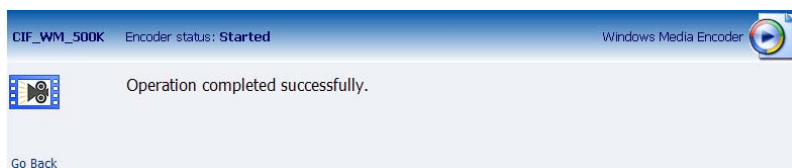
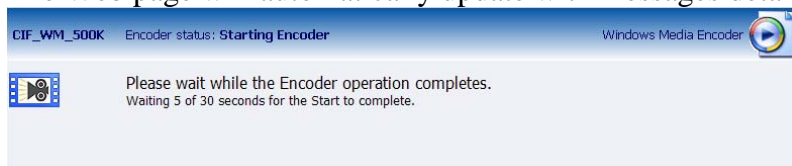

After the encoder has started successfully, the Web page will return to the *All Encoders page* with the encoder status updated to reflect *Started* mode.

Home Encoders Configuration Status Log Out

Encoders

This page allows you to perform encoder setup and removal.

Auto refresh page [Add Encoder](#)

GoStream Encoders | Total records : 7

Name	Description	Last Status	Streaming	Preset
Edit Del CIF_RV_512K	Helix Producer Encoder	OK	Stopped	
Edit Del CIF_WM_500K	Windows Media Encoder	Encoder started	Started	

Stop Encoder

Home Encoders Configuration Status Log Out

Encoders

This page allows you to perform encoder setup and removal.

Auto refresh page [Add Encoder](#)

GoStream Encoders | Total records : 7

Name	Description	Last Status	Streaming	Preset
Edit Del CIF_RV_512K	Helix Producer Encoder	OK	Stopped	
Edit Del CIF_WM_500K	Windows Media Encoder	Stopped	Stopped	

Press the blue *Stop* icon located in the right column of the encoder you wish to stop.

Home Encoders Configuration Status Log Out

Encoders

This page allows you to perform encoder setup and removal.

Auto refresh page [Add Encoder](#)

GoStream Encoders | Total records : 7

Name	Description	Last Status	Streaming	Preset
Edit Del CIF_RV_512K	Helix Producer Encoder	Encoder Stopped	Stopped	
Edit Del CIF_WM_500K	Windows Media Encoder	Encoder started	Started	

The Web page will automatically update with messages detailing the encoder stop progress.

CIF_WM_500K Encoder status: **Stopping Encoder** Windows Media Encoder

Please wait while the Encoder operation completes.
Waiting 5 of 30 seconds for the Stop to complete.

CIF_W_500K Encoder status: **Stopped** Windows Media Encoder

Operation completed successfully.

[Go Back](#)

After the encoder has started successfully, the Web page will return to the *All Encoders page* with the encoder status updated to reflect *Stopped* mode.

Encoders
This page allows you to perform encoder setup and removal.

Auto refresh page [Add Encoder](#)

GoStream Encoders | Total records : 7

Name	Description	Last Status	Streaming	Preset
Edit Del CIF_AVI	AVI Encoder Driver	Encoder Stopped	Stopped	
Edit Del CIF_FLV_512K	Flash Encoder	OK	Stopped	
Edit Del CIF_RV_512K	Helix Producer Encoder	OK	Stopped	
Edit Del CIF_WM_500K	Windows Media Encoder	OK	Stopped	
Edit Del MPEG4	MPEG4 Encoder Driver	Started	Started	
Edit Del QCIF_RV_56K	Helix Producer Encoder	OK	Stopped	
Edit Del QCIF_WM_50K	Windows Media Encoder	OK	Stopped	

Edit Encoder

To edit an encoder, click the *Edit link* in the first column.

GoStream Encoders | Total records : 7

Name	Description
Edit Del CIF_AVI	AVI Encoder Driver OK
Edit Del CIF_R_350K	Helix Producer Encoder OK
Edit Del CIF_R_768K	Helix Producer Encoder OK

The properties page for that encoder will be displayed.

Video & Audio Settings

The properties page for each encoder type uses the same *Video* and *Audio Settings* except for the added color space setting for AVI and Flash.

Home Encoders > Configuration > Status > Log Out

Encoder Properties

Name: Stopped Windows Media Encoder

Video Settings	Audio Settings	Preset
<input checked="" type="checkbox"/> Source: <input type="text" value="Osprey-230 Video Device 1.5"/>	<input checked="" type="checkbox"/> Source: <input type="text" value="Osprey-230 Audio Device 1"/>	None
Input: <input type="text" value="Composite"/>	Input: <input type="text" value="Unbalanced"/>	
Signal: <input type="text" value="NTSC_M"/>		
Proportions: <input type="text" value="Standard"/>		
Size: <input type="text" value="CIF 320x240"/>		

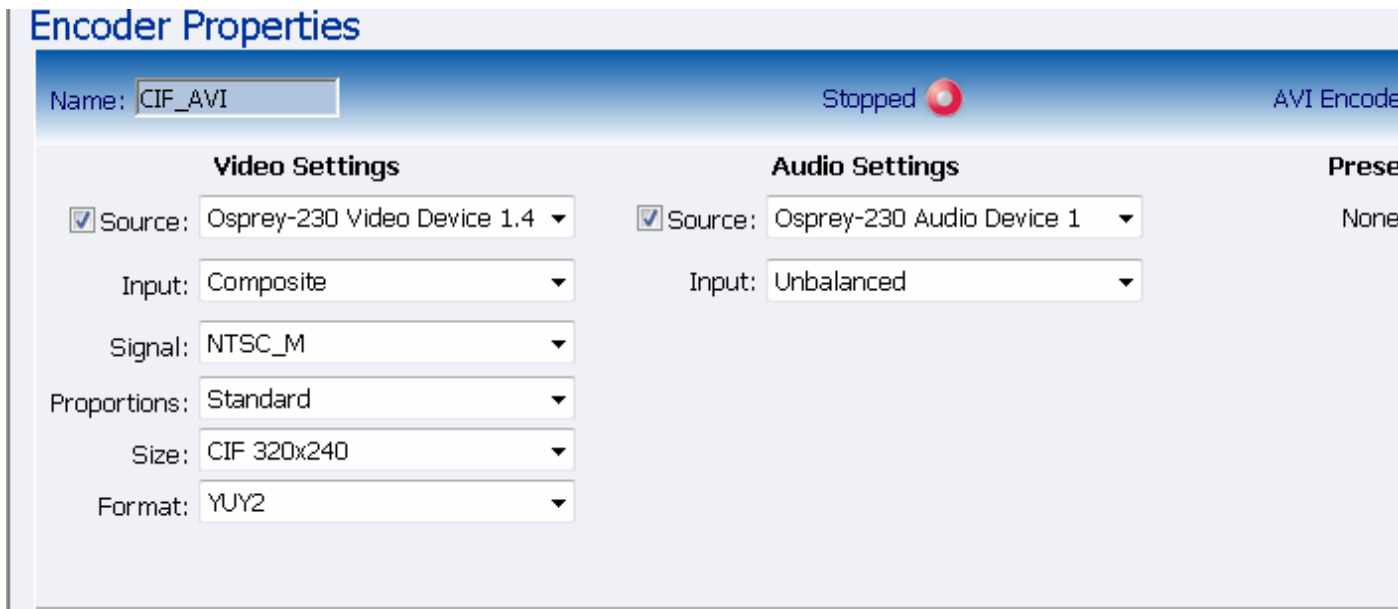

NOTE: The preceding image has an added color space in the form of a field entitled *Format*.

You enable or disable video and/or audio by clicking the check box next to *Source*: When enabled, the *Source*, *Input*, *Signal*, *Proportions*, *Size*, and *Input fields* can be edited.

Source: This field displays a drop-down list of devices available on the encoder. The encoder is a single channel encoder so there is only one physical set of audio and video inputs can be used at any one time. However, you can capture multiple streaming formats and resolutions simultaneously from this one set of video inputs. Video source is seen as multiple inputs denoted by incrementing decimal values. They appear in this manner:



By default, all of the CIF resolution encoders are set to Video Device 1.1 and all of QCIF resolution encoders are set to Video Device 1.2.

Set **Input** for both video and audio to match the video and audio inputs on the back of the encoder to which you connected your video and audio source. This would be either **Composite** or **S-Video** for video input and **Balanced** or **Unbalanced** for audio input.

When you performed the **First Start Setup**, you determined if your video signal was NTSC or PAL. The **Signal field** adds granularity for regional NTSC, PAL, and SECAM settings. If you are uncertain which setting applies, refer to the owner's manual for the video source that you have connected to the encoder.

The proportion setting uses the term **Standard**, meaning square pixels for a VGA monitor and **CCIR-601** meaning elongated pixels for a television monitor. Choose the setting that reflects the type of display on which your content will be viewed. For example, if you will be streaming your video on the Internet to be viewed on a computer monitor, select **Standard**. Selecting the incorrect setting can make the streaming video appear distorted.

The **size field** refers to the pixel size of the encoded video. The standard sizes are as follows:

- Full for full screen video
- CIF for video scaled from full size to 1/4 size
- QCIF for video scaled from full size to 1/4 of CIF size

NOTE: The **encoder size field setting** should be not greater than CIF resolution.

You can also specify a custom size for your video. This is useful when capturing video to be played on a mobile video device that requires a non-standard size for compatibility. If you select **Custom** from the drop-down menu, two additional fields will appear allowing to type in the exact size you want the resulting video to be.

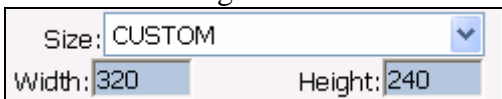

A screenshot of a video settings interface. It shows a 'Size' dropdown menu set to 'CUSTOM'. Below it, two input fields are visible: 'Width: 320' and 'Height: 240'.

NOTE: The Custom Setting is not available with the Flash video codec.

NOTE: If you specify a video size that is not compatible with the color space of your source video, encoder will automatically correct the size to the closest compatible setting when you click the **Submit button**. The color space format setting is only available in AVI and Flash encoder properties and appears as an additional field under the **Size setting**.

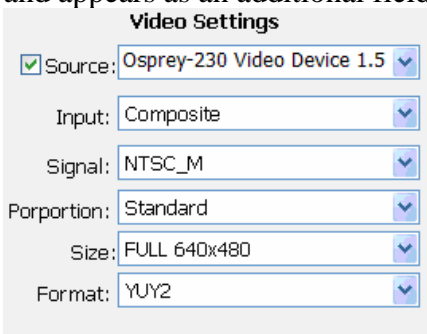

A screenshot of the 'Video Settings' panel. It includes a checked 'Source' dropdown set to 'Osprey-230 Video Device 1.5', an 'Input' dropdown set to 'Composite', a 'Signal' dropdown set to 'NTSC_M', a 'Porportion' dropdown set to 'Standard', a 'Size' dropdown set to 'FULL 640x480', and a 'Format' dropdown set to 'YUY2'.

Now that you have completed all of the *Video* and *Audio settings*, you can proceed to the *encoder type settings* at the bottom of the page. As previously stated, these settings will vary according to the encoder type.

AVI Encoder Settings

Encoder Properties | New Encoder Added

Name: Stopped AVI Encoder Driver

Video Settings	Audio Settings	Preset
<input checked="" type="checkbox"/> Source: <input type="text" value="Osprey-230 Video Device 1.4"/>	<input checked="" type="checkbox"/> Source: <input type="text" value="Osprey-230 Audio Device 1"/>	None
Input: <input type="text" value="Composite"/>	Input: <input type="text" value="Unbalanced"/>	
Signal: <input type="text" value="NTSC_M"/>		
Proportions: <input type="text" value="Standard"/>		
Size: <input type="text" value="CIF 320x240"/>		
Format: <input type="text" value="YUY2"/>		

[Bottom](#)

Advanced Streaming Settings

SimulStream

Enable SimulStream
 Enable multiple instances for each filter
Show filters per device.

Deinterlace

Type:

Motion Threshold

Smooth Sharp
Value:

Streaming to a File

Output to file
File Name: [...](#) [default folder](#)

[All Encoders](#) [Delete Encoder](#) [Top](#)

AVI is an uncompressed audio and video storage format and therefore has only the ability to save to a file. You can type in a unique name for the generated AVI file and modify the directory path to where the file will be stored. Clicking the **Default Folder link** will insert the path of the default folder for file storage on the encoder. By default, the path is d:\AVFILES\.

NOTE: We do not recommend that you store files in any other directory on the encoder. This directory provides approximately 30 gigabytes of data storage, which is not available on any other internal hard drive on encoder.

Once you save your file to the encoder internal hard drive, we recommend that you move it to another external storage device such as a USB drive or a network drive.

After you have input your settings, click the **Submit button** at the bottom of the page to save your changes.

Warning: If you click away to another Web page without first clicking **Submit**, your changes will be lost.



Flash Encoder Settings

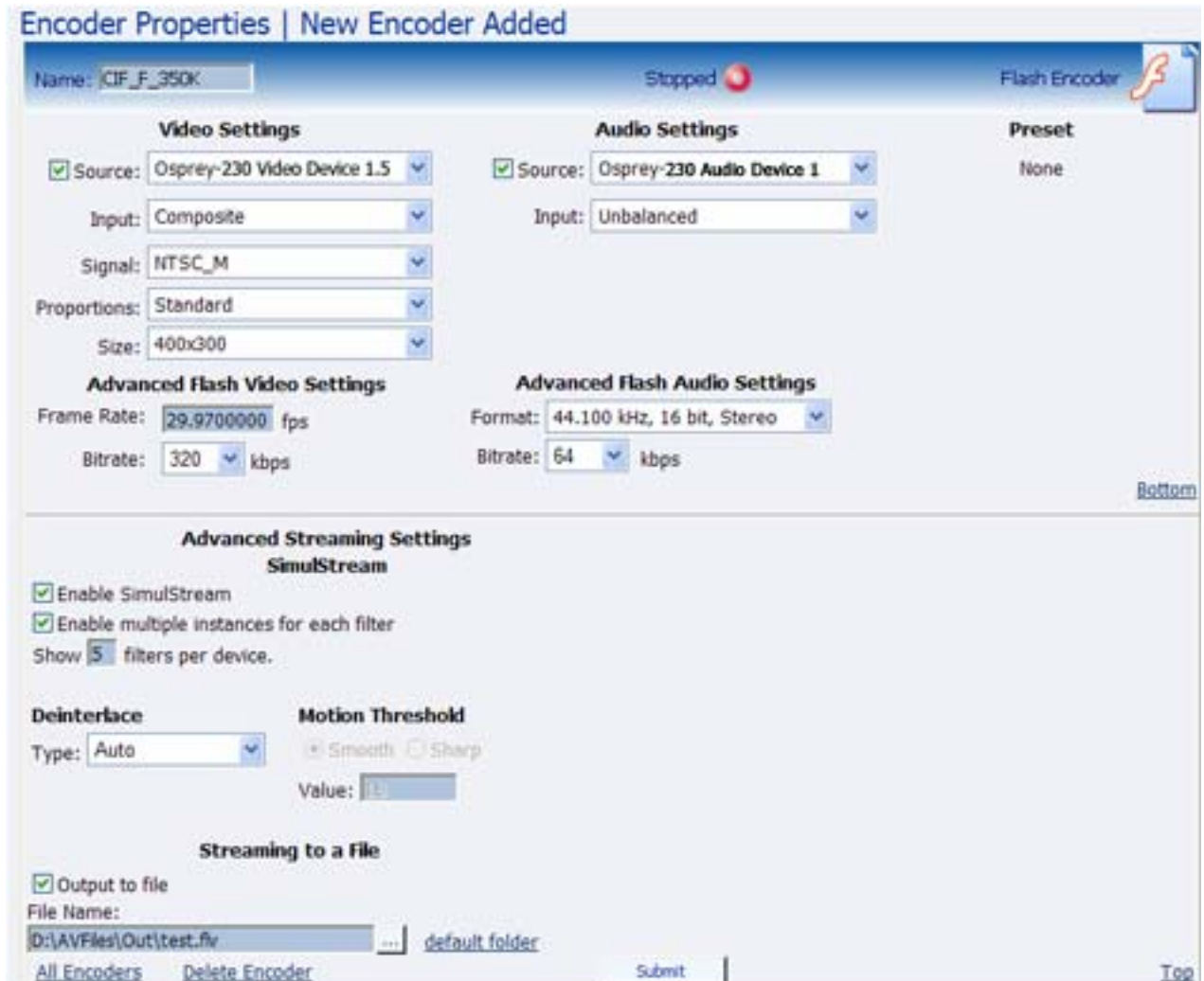

The Flash encoder settings are similar to the AVI settings for saving the audio and video to a file. However, Flash adds some additional frame and bit rate controls. The frame rate changes the frames per second that the video will be encoded. The audio format setting can be used to modify the audio frequency and changes stereo to mono. The bit rate settings pertain to the amount of data per second the audio and video are captured. Decreasing the bit rate for both or either will decrease the playback viewing quality.

The Flash encoder creates a Flash format audio and video file. You can type in a unique name for the Flash file (.flv).

After you have input your settings, click the **Submit button** at the bottom of the page to save your changes.

Warning: If you click away to another Web page without clicking **Submit**, your changes will be lost.



MPEG-4 Encoder Settings

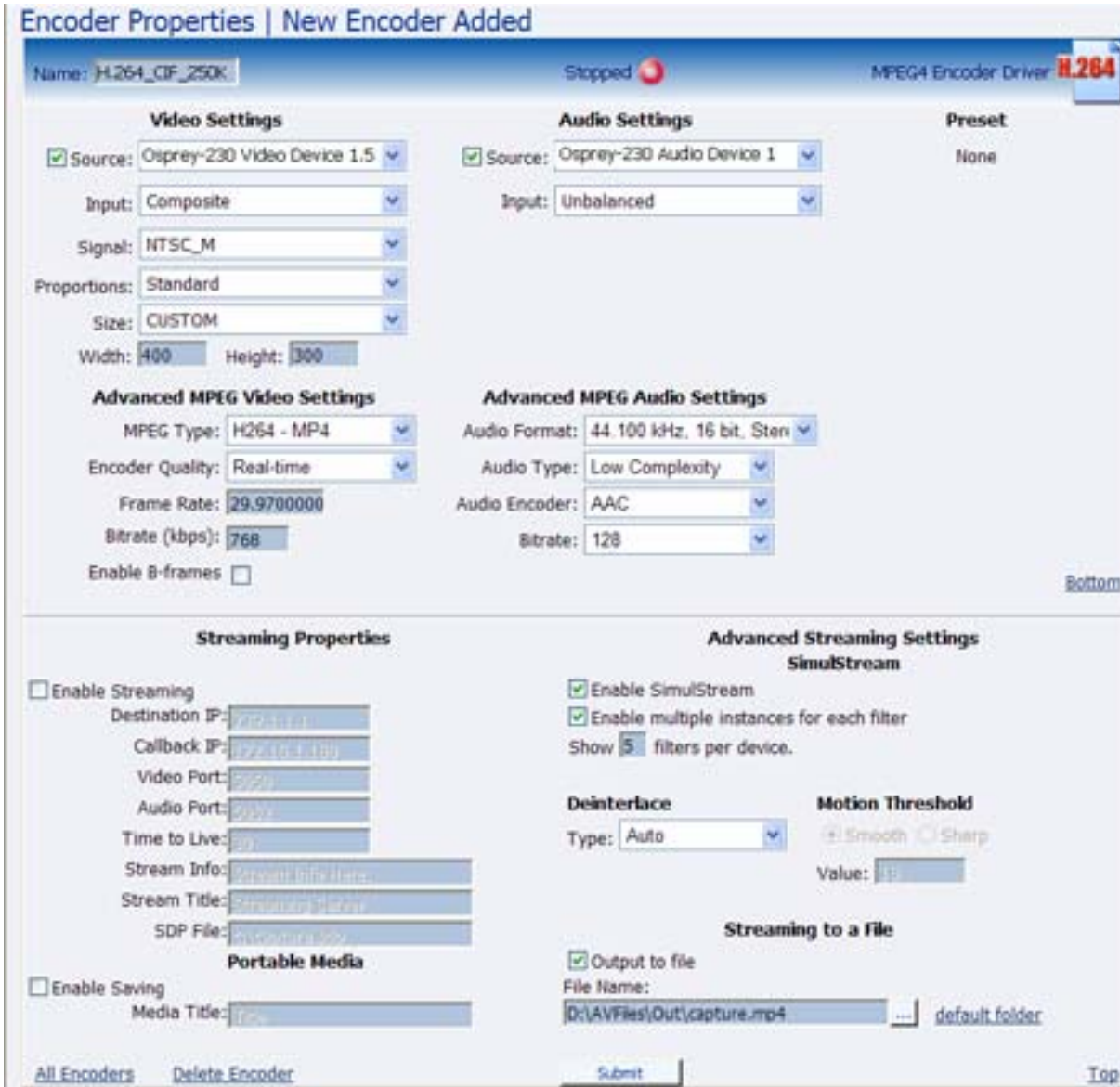

The image shows a web interface for configuring an MPEG-4 encoder. The title is "Encoder Properties | New Encoder Added". The encoder name is "H.264_CIF_250K" and it is currently "Stopped". The interface is divided into several sections:

- Video Settings:** Source: Osprey-230 Video Device 1.5, Input: Composite, Signal: NTSC_M, Proportions: Standard, Size: CUSTOM, Width: 400, Height: 300.
- Audio Settings:** Source: Osprey-230 Audio Device 1, Input: Unbalanced.
- Advanced MPEG Video Settings:** MPEG Type: H264 - MP4, Encoder Quality: Real-time, Frame Rate: 29.9700000, Bitrate (kbps): 768, Enable B-frames: .
- Advanced MPEG Audio Settings:** Audio Format: 44.100 kHz, 16 bit, Stereo, Audio Type: Low Complexity, Audio Encoder: AAC, Bitrate: 128.
- Streaming Properties:** Enable Streaming. Destination IP: 224.0.0.1, Callback IP: 224.0.1.100, Video Port: 2220, Audio Port: 2221, Time to Live: 90, Stream Info: Streaming to file, Stream Title: Streaming to file, SDP File: Streaming to file.
- Advanced Streaming Settings:** Enable SimulStream, Enable multiple instances for each filter, Show 5 filters per device.
- Deinterlace:** Type: Auto.
- Motion Threshold:** Smooth, Sharp, Value: 10.
- Streaming to a File:** Output to file, File Name: D:\AVFiles\Out\capture.mp4, default folder.
- Portable Media:** Enable Saving, Media Title: .

At the bottom, there are links for "All Encoders", "Delete Encoder", "Submit", and "Top".

NOTE: The preceding image is an example of saving to a file. MPEG files cannot be saved to a file and streamed simultaneously.

Encoder Properties | New Encoder Added

Name: H.264_CIF_250K Stopped MPEG4 Encoder Driver H.264

Video Settings	Audio Settings	Preset
<input checked="" type="checkbox"/> Source: Osprey-230 Video Device 1.5	<input checked="" type="checkbox"/> Source: Osprey-230 Audio Device 1	None
Input: Composite	Input: Unbalanced	
Signal: NTSC_M		
Proportions: Standard		
Size: CUSTOM		
Width: 400 Height: 300		
Advanced MPEG Video Settings	Advanced MPEG Audio Settings	
MPEG Type: H264 - MP4	Audio Format: 44.100 kHz, 16 bit, Ster	
Encoder Quality: Real-time	Audio Type: Low Complexity	
Frame Rate: 29.9700000	Audio Encoder: AAC	
Bitrate (kbps): 768	Bitrate: 128	
Enable B-frames <input type="checkbox"/>		

[Bottom](#)

Streaming Properties	Advanced Streaming Settings
<input checked="" type="checkbox"/> Enable Streaming	<input checked="" type="checkbox"/> Enable SimulStream
Destination IP: 239.1.1.1	<input checked="" type="checkbox"/> Enable multiple instances for each filter
Callback IP: 172.16.1.180	Show 5 filters per device.
Video Port: 5050	
Audio Port: 5052	
Time to Live: 30	
Stream Info: Stream Info Here.	Deinterlace
Stream Title: Streaming Server	Type: Auto
SDP File: c:\capture.sdp	Motion Threshold
<input type="checkbox"/> Enable Saving	Smooth Sharp
Media Title:	Value: 10
	Streaming to a File
	<input type="checkbox"/> Output to file
	File Name: D:\Video\Output\Encoder\mp4...

[Top](#)

[All Encoders](#) [Delete Encoder](#) [Submit](#)

NOTE: The preceding image is an example of streaming. MPEG files cannot be saved to a file and streamed simultaneously.

Encoder Settings Web Interface

The encoder software MPEG-4 compression engine provides H.263, MPEG-4 Part 2 SP/ASP, and H.264/MPEG-4 Part 10 Baseline encoding functionality. This product provides the capabilities to encode streams for Internet video, mobile phones, set top boxes and create media files for other MPEG-4 compatible devices such as iPods®.

The Niagara SCX Web Interface provides options for basic and advanced settings for the video and audio options of MPEG-4 available with the encoder.

The figure below illustrates the screen you will see after creating an encoder through the Niagara SCX Web Interface.

The screenshot displays the 'Encoder Properties | New Encoder Added' web interface. At the top, the encoder name is 'H.264_CF_250K', the status is 'Stopped', and the driver is 'MPEG4 Encoder Driver H.264'. The interface is divided into several sections:

- Video Settings:** Source: Osprey-230 Video Device 1.5, Input: Composite, Signal: NTSC_M, Proportions: Standard, Size: CUSTOM, Width: 400, Height: 300.
- Audio Settings:** Source: Osprey-230 Audio Device 1, Input: Unbalanced.
- Advanced MPEG Video Settings:** MPEG Type: H264 - MP4, Encoder Quality: Real-time, Frame Rate: 29.9700000, Bitrate (kbps): 768, Enable B-frames: .
- Advanced MPEG Audio Settings:** Audio Format: 44.100 kHz, 16 bit, Stereo, Audio Type: Low Complexity, Audio Encoder: AAC, Bitrate: 128.
- Streaming Properties:** Enable Streaming. Fields for Destination IP, Callback IP, Video Port, Audio Port, Time to Live, Stream Info, Stream Title, and SDP File.
- Advanced Streaming Settings SimuStream:** Enable SimuStream, Enable multiple instances for each filter, Show 5 filters per device.
- Deinterlace:** Type: Auto, Motion Threshold: Value: 10.
- Streaming to a File:** Output to file, File Name: D:\AVFiles\Out\capture.mp4 default_folder.
- Portable Media:** Enable Saving, Media Title: [Field].

Navigation links at the bottom include 'All Encoders', 'Delete Encoder', 'Submit', and 'Top'.

The *Advanced MPEG Video Settings* provide you with the ability to choose the *MPEG Type* required for your output. As set forth in the figure and descriptions of the *MPEG Types* set forth below, these include the following:

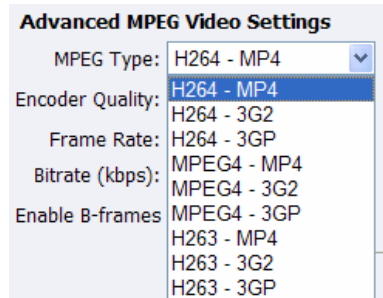

H.264 – MP4

H.264, MPEG-4, Part 10, or AVC (Advanced Video Coding) was designed for very high-data compression while maintain better quality than its predecessor, H.263. It was also created to address a broad range of applications from low bit rate to high bit rate and from low resolution such as cell phones to high resolution such as broadcast.

The encoder's H.264 is Baseline Profile.

H.264 – 3G2

This setting will create an H.264 stream stored in a 3G2 container.

H.264 – 3GP

This setting will create an H.264 stream stored in a 3GPP container.

MPEG4 – MP4

MPEG-4 is the basic MP4 compression which can be used for Web (streaming media) and mobile devices. Use this compression setting if you are experiencing compatibility issues with your playback software or device when using H.263 or H.264.

MPEG4 – 3G2

This setting will create an MPEG-4 stream stored in a 3G2 container.

MPEG4 – 3GP

3GP is a multimedia container format defined by the Third Generation Partnership Project (3GPP) for use on 3G mobile phones. It stores video streams such as MPEG-4 or H.264 and audio streams such as AMR or AAC.

There are two defined standards for this format which are:

- 1) 3GPP for GSM based mobile phones
- 2) 3GPP2 for CDMA based mobile phones

This setting will create an MPEG-4 stream stored in a 3GPP container.

H.263 – MP4

MPEG-4, Part 2, or H.263, is designed for situations where low bit rate and low resolution are mandated by other conditions of the applications, like network bandwidth or device size. Examples of video applications for H.263 are cell phones, some low end video conferencing systems, and surveillance systems. H.263 is important for legacy handheld devices that do not support H.264.

NOTE: By default, encoder's H.263 uses Simple Profile unless you select the "Enable B Frames" option. If B frames are enabled, then the resulting stream will be Advanced Simple Profile.

H.263 – 3G2

This setting will create an H.263 stream stored in a 3G2 container.

H263 – 3GP

This setting will create an H.263 stream stored in a 3GPP container.

Also included under **Advanced MPG Video Settings** are drop-down boxes for **Encoder Quality**, ranging from **Real-time** to **Highest**, along with **Frame Rate** and the **Bitrate (kbps)**.

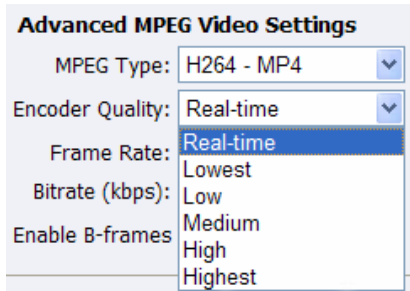

The screenshot shows the 'Advanced MPEG Video Settings' dialog box. It contains several settings: 'MPEG Type' is set to 'H264 - MP4'; 'Encoder Quality' is set to 'Real-time'; 'Frame Rate' is set to 'Real-time'; 'Bitrate (kbps)' is set to 'Low'; and 'Enable B-frames' is set to 'High'. A dropdown menu is open for 'Encoder Quality', showing options: 'Real-time', 'Lowest', 'Medium', 'High', and 'Highest'.

NOTE: The **Video/Encoder Quality** setting is currently not active and will not affect the results of the encoding stream or file.

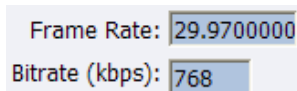

The screenshot shows two input fields: 'Frame Rate' with the value '29.9700000' and 'Bitrate (kbps)' with the value '768'.

NOTE: Some players, such as Quicktime[®] player, are not compatible with streams that include B frames. If your resulting stream has quality issues on playback, try disabling B frames to ensure compatibility with most players.

The **Advanced MPG Audio Settings**, provide you with several **Audio Formats**, **Audio Types**, **Audio Encoders**, and **Bitrates** from which to choose. These choices include several options as to audio sampling, and whether the audio is to be encoded monophonically (mono) or stereo.

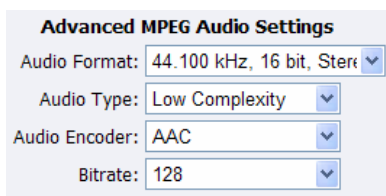

The screenshot shows the 'Advanced MPEG Audio Settings' dialog box. It contains several settings: 'Audio Format' is set to '44.100 kHz, 16 bit, Ster'; 'Audio Type' is set to 'Low Complexity'; 'Audio Encoder' is set to 'AAC'; and 'Bitrate' is set to '128'.

Advanced MPEG Audio Settings

Audio Format: 44.100 kHz, 16 bit, Stere

Audio Type: 11.025 kHz, 8 bit, Mono
11.025 kHz, 8 bit, Stereo

Audio Encoder: 11.025 kHz, 16 bit, Mono
11.025 kHz, 16 bit, Stereo

Bitrate: 22.050 kHz, 8 bit, Mono
22.050 kHz, 8 bit, Stereo
22.050 kHz, 16 bit, Mono
22.050 kHz, 16 bit, Stereo
33.075 kHz, 8 bit, Mono
33.075 kHz, 8 bit, Stereo
33.075 kHz, 16 bit, Mono
33.075 kHz, 16 bit, Stereo
44.100 kHz, 8 bit, Mono
44.100 kHz, 8 bit, Stereo
44.100 kHz, 16 bit, Mono
44.100 kHz, 16 bit, Stereo

The **Audio Type** setting is only related to **AAC Encoding**. If you select **AMR** in the **Encoder field**, this setting is not used. The **Audio Type** field provides you with a drop-down box, which includes two choices, as follows:

Main – This format is the same as LC (above), but adds backward prediction.

Low Complexity (LC) – The simplest and most widely used and support AAC audio format.

Advanced MPEG Audio Settings

Audio Format: 44.100 kHz, 16 bit, Stere

Audio Type: Low Complexity

Audio Encoder: Main
Low Complexity

Bitrate: 128

NOTE: Depending on the player on which the resulting stream will be heard, either choice will use a specific set of tools to encode the audio stream. You should make your choice based on the requirement of the playback software or device. The most widely supported format is LC profile.

The **Audio Encoder settings** provide you with a drop-down box, which includes two choices, as follows:

AAC (Advanced Audio Coding) is a standardized, lossy compression and encoding scheme for digital audio. AAC achieves better audio quality than MP3 and has been named a standard by the Motion Picture Experts Group (MPEG)

AMR (Adaptive Multi-Rate Narrow-Band) is an audio data compression scheme optimized for speech coding. AMR was adopted as the standard narrowband speech codec by 3GPP and is widely used in GSM.

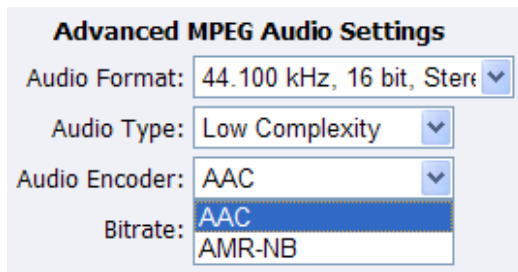

The image shows a screenshot of a software interface titled "Advanced MPEG Audio Settings". It contains four dropdown menus:

- Audio Format: 44.100 kHz, 16 bit, Stereo
- Audio Type: Low Complexity
- Audio Encoder: AAC
- Bitrate: AAC (highlighted), AMR-NB

NOTE: When you select AMR Encoder for audio, the audio will automatically be encoded using 8 kHz mono for playback on cell phones. The **Audio Bitrate** drop-down box provides you with several choices, as can be seen in the figure below.

Advanced MPEG Audio Settings

Audio Format: 44.100 kHz, 16 bit, Stereo

Audio Type: Low Complexity

Audio Encoder: AAC

Bitrate: 128

- 8
- 10
- 12
- 14
- 16
- 20
- 24
- 28
- 32
- 40
- 48
- 56
- 64
- 80
- 96
- 112
- 128
- 160
- 192
- 224
- 256
- 320

The Web interface for the encoder includes options for *Streaming Properties* and *Advanced Streaming Properties*. As to the broadcast type you choose, you have the option to check the *Enable Streaming* box. Please see the following section entitled *Real Encoder (Helix)* for a more detailed description of enabling pull. Another option provides you the abilities to *Save to Portable Media* and provide a *Media Title*.

<p>Streaming Properties</p> <p><input checked="" type="checkbox"/> Enable Streaming</p> <p>Destination IP: 239.1.1.1</p> <p>Callback IP: 172.16.1.177</p> <p>Video Port: 5050</p> <p>Audio Port: 5052</p> <p>Time to Live: 30</p> <p>Stream Info: Stream Info Here.</p> <p>Stream Title: Streaming Server</p> <p>SDP File: c:\capture.sdp</p> <p>Portable Media</p> <p><input type="checkbox"/> Enable Saving</p> <p>Media Title: Title</p>	<p>Advanced Streaming Settings</p> <p>SimulStream</p> <p><input checked="" type="checkbox"/> Enable SimulStream</p> <p><input checked="" type="checkbox"/> Enable multiple instances for each filter</p> <p>Show 5 filters per device.</p> <p>Deinterlace</p> <p>Type: Motion Adaptive</p> <p>Motion Threshold</p> <p><input checked="" type="radio"/> Smooth <input type="radio"/> Sharp</p> <p>Value: 17</p> <p>Streaming to a File</p> <p><input type="checkbox"/> Output to file</p> <p>File Name: D:\AVFiles\Out\capture.mp4 default folder</p>
---	---

[All Encoders](#) [Delete Encoder](#)

Under the *Advanced Streaming Settings* feature, you have the options to output to a file while streaming, or output only to a file. You must type in a unique name and location for this file.

Streaming to a file

Output to file

File Name:

D:\AVFiles\Out\capture.mp4 ... default folder

Submit

NOTE: Remember the file name is referenced to the encoder system, not to the system running SCX Explorer.

When SCX Manager and SCX Explorer are not on the same computer, always start your browse for files at **My Network Places** and work down or enter the entire file pathname beginning with the system name (e.g., \\fileserver\c\videos). If you simply enter a file name, you may inadvertently browse your local computer when the media file resides on the remote computer.

To stream your MPEG-4 content, select **Enable Streaming**. Set the appropriate streaming properties.

NOTE: The default settings will enable multicast streaming. If this is not desired, change the IP address for Group to the IP address of the server to which you want to stream from the encoder.

The **Save sdp file field** will require a name and destination path for the resulting SDP file created when the stream is started. If you are streaming to a Helix[®], a Quicktime, or a Darwin server, refer to its respective documentation or online message boards for setup details specific for the individual streaming server.

NOTE: You can stream point-to-point by selecting a share destination directory for the saved SDP file. Remember to disable multicasting by entering in the IP address of the PC to which you want to stream.

For example, if you want another PC to view the stream, save the SDP file to a share folder on the local drive. The other PC can open the SDP file and the stream can be played in a Quicktime or other MPEG-4 compatible streaming player. Since MPEG-4 encoding can be CPU intensive, it is not recommend that you view the stream on the same system as the encoder unless you have a very powerful system (dual-core processors or better). Doing so may overtax the host CPU which will cause video quality degradation and encode session failure.

After you have input your settings, click the **Submit button** at the bottom of the Web interface page to save your settings.



NOTE: If you click away to another Web page without first clicking **Submit**, your changes will be lost.

Real Encoder Settings (Helix)

The screenshot displays the 'Encoder Properties | New Encoder Added' window for a 'Real Producer' encoder. The interface is divided into several sections:

- Video Settings:** Source is 'Osprey-5X0 Video Device 1.6', Input is 'Composite', Signal is 'NTSC_M', Proportions is 'Standard', and Size is 'QCIF 160x120'.
- Audio Settings:** Source is 'Osprey-5X0 Audio Device 1', Input is 'Unbalanced'.
- Preset:** Set to 'None'.
- Streaming Properties:** 'Enable Streaming' is checked. Broadcast Method is 'Legacy Push (ver 8.x, 7.x, G2)'. Transport is 'UDP'. Server Address, Port/Port Range (4040), Multicast Address, Listen Address (Automatic), Stream Name, Path, User Name, Password, and Frame Rate (15) are all empty text boxes. Video Quality is 'Normal Motion Video', Audio Content is 'Voice with Background Music', and Video Noise Filter is 'Off'. There are checkboxes for 'De-Interlace filter' and 'Inverse Telecine'.
- Advanced Streaming Settings:** 'Enable SureStream' is unchecked. Under 'Audience Selection', several options are unchecked, including '100% Quality Download (VBR)', '128k Dual ISDN', '12k Substream for 28k Dial-up', '150k LAN', '16k Substream for 28k Dial-up', and '1M Download (VBR)'. Under 'SimulStream', 'Enable SimulStream' and 'Enable multiple instances for each filter' are checked, with 'Show 5 filters per device'. Under 'Deinterlace', Type is 'Auto'. Under 'Motion Threshold', 'Smooth' is selected and the value is 10. Under 'Streaming to a file', 'Output to file' is unchecked, and the File Name field is empty.

Buttons at the bottom include 'All Encoders', 'Delete Encoder', 'Submit', and 'Top'.

Real (Helix) is both a storage format and a streaming format. Besides the ability to output to a file, the Real Encoder can stream to a Helix Server. The settings for the Real Encoder include the ability to adjust parameters for connecting and streaming to the server.

Broadcast Method: Legacy Push (ver 8.x, 7.x, G2)

Broadcast Method: There are several different broadcast types for streaming Real format video to a Helix Server. They are as follows:

- **Push, Account-Based Login (Helix Server)**
 - Account-based, push broadcasting allows you to send a stream to Helix Server version 9 or later. In this method, encoder maintains a monitoring connection to Helix Server. This connection allows it to pass a user name and password to authenticate access to the server. Helix Server uses this connection to send statistics about the broadcast stream back to encoder.
- **Push, Password-Only (Helix Server)**
 - Unlike account-based broadcasting, password-only broadcasting does not establish a monitoring connection. It therefore incurs less network overhead, but it receives no feedback from Helix Server. This broadcast method allows you to send a live stream to Helix Server version 9 or later. You must set up the server as a receiver in a splitting arrangement, however. Please refer to the Helix Server documentation included with the Helix Server for details.
- **Push, Multicast (Helix Server)**
 - In a multicast, encoder can deliver the same broadcast stream to any number of Helix Servers without increasing its outgoing bandwidth. The Helix Servers will need to be pre-configured for a multicast from encoder. Refer to your Helix Server documentation for details.
- **Pull (Helix Server)**
 - In pull broadcasting, encoder begins to generate broadcast packets as soon as you start the encoding. However, it does not deliver the broadcast stream until Helix Server requests the stream, which occurs when the first RealPlayer user requests the broadcast. Pull broadcasting thereby saves bandwidth between encoder and Helix Server when no one is viewing the broadcast. This broadcast method allows you to send a stream to Helix Server version 9 or later.
- **Legacy Push (8.x, 7.x, G2)**
 - The legacy push method is similar to the account-based push method. It does not use a monitoring connection to provide server feedback and statistics, however, and is not as robust a broadcast method as account-based push. Use this broadcast method only when sending a broadcast stream to a server that predates Helix Server version 9, such as RealSystem Server G2, 7, or 8.

Transport Protocol: When you use a push broadcast method, you specify whether to use UDP or TCP when delivering the broadcast stream to Helix Server. UDP is the preferred protocol because of the lower network overhead. But you may want to use TCP when delivering the broadcast over a lossy environment.

Transport: UDP TCP

For the **Server Address field**, enter the IP address or DNS name of the Helix Server used for the broadcast, such as 207.188.7.176 or helixserver.example.com.

Server Address:

For the **Port/Port Range fields**, specify the HTTP port on Helix Server. The default value is port 80, which is the server's default HTTP port. If multicasting, indicate the range of ports on the Helix Server receivers where the broadcast packets will be sent. encoder and Helix Server negotiate the actual ports to use once the broadcast begins. The default range is 30001 to 30020.

Port/Port Range:

If using a **Multicast Address**, enter the multicast address for the broadcast stream in the **Multicast Address field**. It must be in the range 224.0.0.0 to 239.255.255.255.

Multicast Address:

In the **Stream Name field**, enter a name for the broadcast stream. This name resembles a clip name and should use the appropriate extension, either .rm for a constant bit rate stream or .rmvb for a variable bit rate stream. This name appears in the broadcast URL.

Stream Name :

The **Path (optional) field** specifies a virtual path, which can be used for archiving or splitting on Helix Server. Use a simple name followed by a forward slash, such as news/.

Path(optional):

In the **User Name** and **Password fields**, enter the user name and password defined in each Helix Server receiver definition. The broadcast connection fails if the value is incorrect.

User Name:
Password:

The next series of fields activate the Real Encoder's filters to improve video and audio quality. These filter settings will depend upon the type of content that you are streaming and your subjective preference. We recommend that you experiment with these settings and view their results on a test capture.

Video Quality:
Audio Content:
Video Noise Filter:
 De-Interlace filter
 Inverse Telecine

The encoder features integrated de-interlacing and inverse telecine filters that automatically apply when needed. This allows the encoder to perform at maximum efficiency. We recommend that you do not enable the Real Encoder deinterlace and inverse telecine filters since applying filters multiple times can produce undesirable results and consume additional system resources.

Advanced Streaming Settings

Audience Selection Enable SureStream

<input type="checkbox"/> 100% Quality Download (VBR)	<input type="checkbox"/> 5M Download (VBR)
<input type="checkbox"/> 128k Dual ISDN	<input type="checkbox"/> 5M Multichannel (VBR)
<input type="checkbox"/> 12k Substream for 28k Dial-up	<input type="checkbox"/> 5M Surround Stereo (VBR)
<input type="checkbox"/> 150k LAN	<input type="checkbox"/> 64k Single ISDN
<input type="checkbox"/> 16k Substream for 28k Dial-up	<input type="checkbox"/> 70% Quality Download (VBR)
<input type="checkbox"/> 1M Download (VBR)	<input type="checkbox"/> 750k Download (VBR)

Select all [Unselect all](#)

Enable SureStream: SureStream allows you to encode the broadcast stream for multiple audiences. However, each primary stream or substream you choose increases the processor load during encoding and adds to the outgoing bandwidth requirements. With SureStream enabled, you can choose the 56k Dial-up audience and the 128k Dual ISDN audience, for example. With SureStream enabled, the encoding may require twice as much processing power.

Regardless of whether or not you enable SureStream, you must choose at least one **Audience Selection** for your stream.

You can also choose to output to a file while streaming or output only to a file. In the **File Name field**, type in a unique name for the file.

Streaming to a file

Output to file

File Name:

D:\AVFiles\Out [default folder](#)

NOTE: If you use the same name as a current file, the current file will be overwritten.

After you have input your settings, click the **Submit button** at the bottom of the page to save your changes.

Warning: If you click away to another Web page without first clicking **Submit**, your changes will be lost.

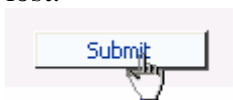

Windows Media Encoder Settings

Windows Media is both a storage format and a streaming format. Besides the ability to output to a file, the Windows Media encoder can stream to a Windows Media Server. The settings for Windows Media encoder include the ability to set parameters for connecting and streaming to the server.

Encoder Properties

Name: Stopped Windows Media Encoder

Video Settings **Audio Settings** **Preset**

Source: Source: None

Input: Input:

Signal:

Proportions:

Size:

[Bottom](#)

Streaming Properties **Advanced Streaming Settings**

Windows Media Capture Profiles:

37 of 55 Use this profile when creating video files for playback on most Pocket PCs.

Enable Pull
 Pull from Port:

Enable Push
 Push to Port:
 Server :
 Alias:
 User Name:
 Password:

Enable Scripting

Enable SimulStream
 Enable multiple instance for each filter
 Show filters per device.

Deinterlace **Motion Threshold**

Type: Smooth Sharp
 Value:

Streaming to a File

Output to file Index the file
 File Name: [default folder](#)

Enable DRM **DRM Settings** (Windows Media only)

Profile:

Description: None
 Key: N/A

Note: Changing the capture profile may change the current video height/width settings as well as the audio/video input capture selection.

[All Encoders](#) [Delete Encoder](#) [Top](#)

First select a *Windows Media Capture Profile* from the drop-down menu.

NOTE: Some *Windows Media Capture Profiles* have pre-defined video resolutions and input selections. When you select a *Windows Media Capture Profile*, verify that your current video and

audio settings have not been modified. If so, simply change these settings back to their previous selection and click the **Submit button**.

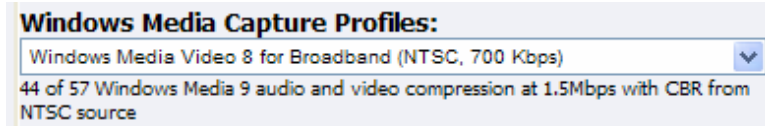

When streaming audio and video, there are two methods of delivery:

- **Pull:** Using this method, the encoder begins to generate broadcast packets as soon as you start the encoding. However, it does not deliver the broadcast stream until Windows Media Server requests the stream. This method does not provide a secure connection to the server and should only be used if the encoder and server reside within the same network firewall.
- **Push:** In this method, the encoder maintains a secure connection to Windows Media Server. This connection allows it to pass a user name and password to authenticate access to the server.

To enable clients to pull the stream from encoder, you simply set up a session and begin broadcasting directly from encoder. Clients (Windows Media servers or players) can connect to the stream at any time by using the following URL format:

- `http://IP_address:port` (for Internet connections)
- `http://encoding_computer_name:port` (for LAN connections)

NOTE: The greater the numbers of direct connections to the encoder, the more system resources are required. It is not recommend having players connect directly to encoder. Streaming servers should connect to encoder and in turn, players should connect to the servers.

Select the **Enable Pull** check box. Then enter a port number that will be used by the server to pull the stream from encoder.

NOTE: Be sure to enter a port number that is not already assigned to another encoder. If two encoders are starting that use the same port number, one or both encoders will fail to start.

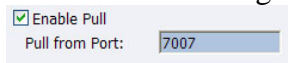

Select **Enable Push** and enter a **port number** that is not assigned to another encoder. Then enter the **server name** or **IP address**, **Alias** (optional), **user name**, and **password**.

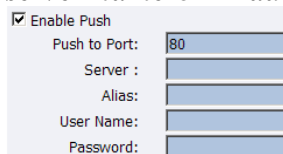

You can also choose to output to file at the same time you are streaming to a server. However, you can set the server to archive the file and streaming allowing encoder to reserve its system resource for encoding. Refer to the Windows Media Server documentation for details.

If you check ***Index the file***, viewers will be able to direct access any point within the Windows Media file using the Windows Media player. Indexing is also required for editing the Windows Media file using Microsoft Windows Media Utilities.

Streaming to a File

Output to file Index the file

File Name:

D:\AVFiles\Full_WM_Capture ... default folder

After you have input your settings, click the ***Submit button*** at the bottom of the page to save your changes.

Warning: If you click away to another Web page without first clicking ***Submit***, your changes will be lost.



Digital Rights Management (DRM) for Windows Media

You can protect your content using a technology called Digital Rights Management (DRM). Niagara SCX allows you to encrypt your content with DRM technology while you are encoding. You can apply DRM while encoding to a file and when broadcasting a stream. Users will be required to obtain a license to play the content. This license contains the key to unlock the content and the rights that govern its use.

NOTE: Licenses are issued by a third-party license provider, so you must set up an account with a third-party license provider to protect your content.

Niagara SCX automatically detects any available DRM profiles imported on the encoding system. If there are no DRM profiles installed, the DRM functions in Niagara SCX are disabled. In order to enable the DRM function in Niagara SCX, you must do the following:

- 1) Set up an account with a third-party license provider and create a DRM profile.
- 2) Import the DRM profile using the Windows Media Encoder application included with Niagara Streaming Systems or available as a free download from Microsoft Corporation (<http://www.microsoft.com>).
- 3) Restart the encoding system on which Niagara SCX is installed, allowing the software to auto-detect and enable its DRM functions.

Importing a DRM Profile

If you have not already done so, set up an account with a licensed provider and create a DRM profile. Once the DRM profile is created, you must use Windows Media Encoder to import the profile on the encoding system.

Windows Media Encoder is included in Niagara Streaming Systems that have Niagara SCX version 5.0 or later installed. To access the desktop of the encoder, use Windows Remote Desktop Connection on a computer that resides on the same network.

IMPORTANT: When connecting to an encoder using a *Remote Desktop Connection*, it is extremely important that you set the *Local Resources* to *Leave at remote computer* before connecting to the system.

To set this appropriately, open *Remote Desktop Connection*.

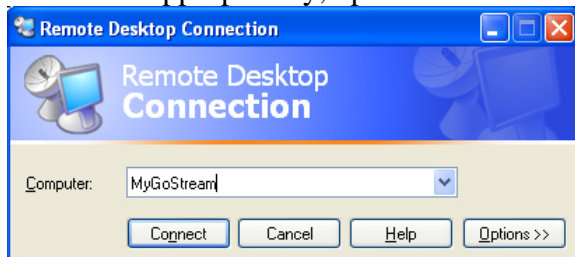

Click the **Options button** so the settings tabs are viewable. Click the **Local Resources** tab. Under the **Remote computer sound setting**, change the drop-down selection to the **Leave at remote computer option**.



You may then enter the **user name** and **password** to access the encoder.

The user name is **encoder** and the password is **password** for connecting to encoder using remote desktop.

IMPORTANT: When exiting from **Remote Desktop Connection**, **DO NOT LOG OUT**. Instead, **DISCONNECT** from the encoder. This allows its internal programs to continue running.

Next, complete the following steps:

- Copy the DRM profiles to a protected location on the encoding system to ensure they will not be accidentally removed or erased. We recommend that you create a new directory on the D drive on the encoder and use this directory to store your DRM profiles.

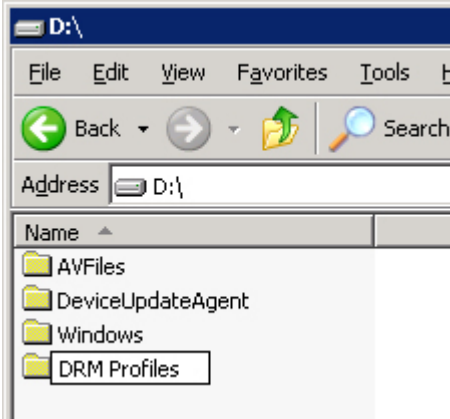

- Start the Windows Media Encoder application on encoder. When the New Session Wizard appears, click the **Cancel** button.

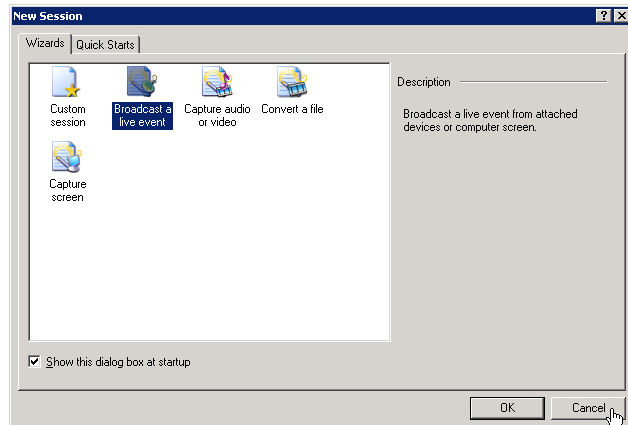
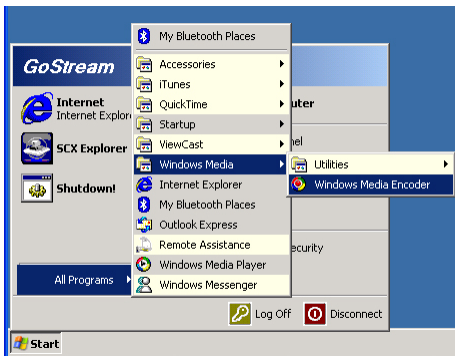

- Click the **Properties** button under the top menu bar.

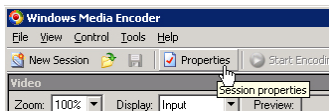

- Click the *Security tab*.

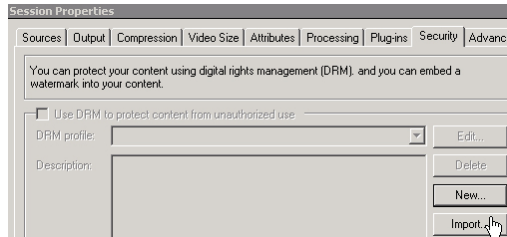

- Click the *Import button* and browse to the location of the DRM profiles on the system's hard drive. Select the DRM profile you wish to import and click the *Open option*.

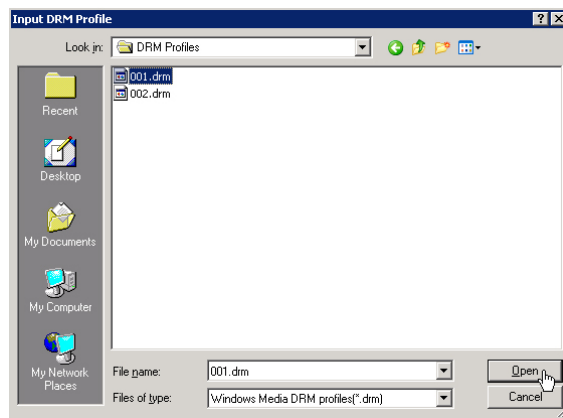

- Repeat this process for each DRM profile you wish to import.
- Exit from the Windows Media Encoder application when finished. If you are asked if you want to save your encoding session, select the *No option*.
- Disconnect Remote Desktop Connection from encoder. Do not log out.



- Restart encoder.

Setting a DRM Profile in SCX Web Interface

To set the DRM Profile using encoder's SCX Web Interface, complete the following steps:

- Either add or edit an existing Windows Media Encoder from the *All Encoders page*.

- To enable DRM, select the **Enable check box** and select the **DRM profile** you wish to apply from the **DRM Settings** drop-down menu.

Streaming to a File

Output to file Index the file default folder

Enabled

DRM Settings (Windows Media only)

Profile: SyncCast - Unlimited Play

Description: buy key for unlimited playback. 12.99

Key:

Note: Changing the capture profile may change the current video height/width settings as well as the audio/video input capture selection.

NOTE: When you enable DRM, Niagara SCX will automatically change the **Windows Media Capture Profile setting** to a **DRM-compatible Windows Media 9 setting**. You might need to adjust this setting after you enable DRM.

After you have input your settings, click the **Submit button** at the bottom of the page to save your changes.

Warning: If you click away to another Web page without first clicking **Submit**, your changes will be lost.



Niagara SCX Web Interface will then display the **All Encoders** list.

Home Encoders Configuration Status Log Out

Encoders
This page allows you to perform encoder setup and removal.

Auto refresh page [Add Encoder](#)



GoStream Encoders | Total records : 8

Name	Description	Last Status	Streaming	Preset
Edit Del CIF_AVI	AVI Encoder Driver	OK	Stopped	
Edit Del CIF_F_350K	Flash Encoder	OK	Stopped	
Edit Del CIF_R_350K	Helix Producer Encoder	OK	Stopped	
Edit Del CIF_R_768K	Helix Producer Encoder	OK	Stopped	
Edit Del CIF_W_350K	Windows Media Encoder	OK	Stopped	
Edit Del CIF_W_768K	Windows Media Encoder	OK	Stopped	
Edit Del MOB_R_56K	Helix Producer Encoder	OK	Stopped	
Edit Del MOB_W_50K	Windows Media Encoder	OK	Stopped	

Delete an Existing Encoder

To delete an existing encoder listed, click the **Del link** next to the name of the encoder you wish to remove. The encoder profile with its settings will be immediately removed from encoder.

GoStream Encoders | Total records : 5



Name	Description
Edit Del FLASH ENCODER  Flash Encoder OK	
Edit Del MPEG4 ENCODER  MPEG4 Encoder Driver OK	
Edit Del QCIF_RV_56K  Helix Producer Encoder OK	

Alternatively, you can click the **Edit link** to view the encoder profile, verify that it is the encoder that you wish to remove.

GoStream Encoders | Total records : 5

Name	Description
Edit Del FLASH ENCODER  Flash Encoder OK	
Edit Del MPEG4 ENCODER  MPEG4 Encoder Driver OK	
Edit Del QCIF_RV_56K  Helix Producer Encoder OK	

Encoder Properties | New Encoder Added

Name: Stopped  AVI Encoder Driver 

Video Settings	Audio Settings	Preset
<input checked="" type="checkbox"/> Source: Osprey-230 Video Device 1.4	<input checked="" type="checkbox"/> Source: Osprey-230 Audio Device 1	None
Input: Composite	Input: Unbalanced	
Signal: NTSC_M		
Proportions: Standard		
Size: CIF 320x240		
Format: YUY2		

[Bottom](#)

Advanced Streaming Settings

SimulStream

Enable SimulStream
 Enable multiple instances for each filter
Show filters per device.

Deinterlace	Motion Threshold
Type: Auto	<input checked="" type="radio"/> Smooth <input type="radio"/> Sharp
	Value: <input type="text" value="10"/>

Streaming to a File

Output to file
File Name: ... default folder

[All Encoders](#) [Delete Encoder](#) [Top](#)

Then click the **Delete Encoder link** at the bottom of the page once you have verified that it is the encoder you want to delete.

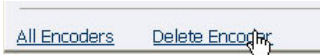

NOTE: You cannot restore a deleted encoder. You must recreate the encoder using the **Add Encoder link** at the top right-hand corner of the **All Encoders page**.

Create an Encoder

The encoder by default has encoding profiles loaded and ready for use. You can create a new encoder for your custom streaming requirements.

Click the **Add Encoder link** in the upper right corner of the screen.

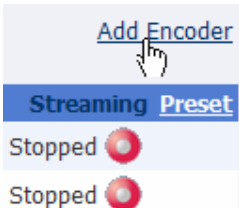

On the next screen, select the encoder type from the drop-down menu. There are four different types of encoders installed in the encoder:

- **AVI** – An uncompressed audio and video file format
- **Flash** – An audio and video file format typically embedded in Flash-authored interactive content
- **RealVideo** – An audio and video file and streaming format
- **Windows Media**® – An audio and video file and streaming format

After you have made your selection, give the encoder a unique name. Keep in mind that only the first 11 characters of the encoder can be displayed on the encoder LCD display. Click the **Add Encoder button** when finished.

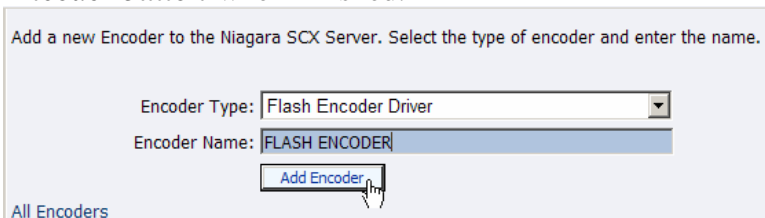

You then return to the **All Encoders page**. The new encoder you created is added to the encoder list. You can then edit that encoder by clicking the **Edit link** next to the encoder name. Read previous section entitled the **Edit Encoder** for information on how to edit the encoder you just created.

Encoders
This page allows you to perform encoder setup and removal.

Auto refresh page [Add Encoder](#)

GoStream Encoders | Total records : 6

Name	Description	Last Status	Streaming	Preset
Edit Del AVI	AVI AVI Encoder Driver	OK	Stopped	
Edit Del FLASH ENCODER	Flash Encoder	OK	Stopped	
Edit Del MPEG4 ENCODER	MPEG4 Encoder Driver	OK	Stopped	A
Edit Del QCIF_RV_56K	Helix Producer Encoder	OK	Stopped	C
Edit Del REAL 1	Helix Producer Encoder	Started	Started	
Edit Del REAL 2	Helix Producer Encoder	Started	Started	

Encoder Preset (A, B, & C)

The encoder provides one-button streaming via the *EZStream buttons* located on the front panel of the system. By default, these buttons are not assigned to an encoder. The *Niagara SCX Web Interface* is used to configure each button to a specific encoder. The controls to configure these buttons are located in the *Encoder Preset A*, *Encoder Preset B*, and *Encoder Preset C* pages.

When you access the *Encoder Preset A page*, you are presented with the configuration option for the *EZStream A button*. On this page is a graphic representation of the front panel of the encoder. The *A button* is highlighted on this graphic, which sets forth that you are actively assigning an encoder to this corresponding *EZStream button*.

Encoder Preset A

This page allows setting the GoStream Encoder Presets. A preset is a quick way to select a specific Encoder. There are three presets on the front panel A, B and C. Click on the **A**, **B** or **C** buttons below or select from the menu to switch between each preset.

When an Encoder is assigned to a preset button, pressing the button on the GoStream panel will allow for quick easy starting or stopping of the encoder. Select an Encoder for the preset or select 'None' to deactivate the GoStream> preset button. When no encoder assignment is made, pressing the GoStream button will show a message reminding you that no Encoder has been defined.

Select Encoder:



This page presents a *Select Encoder field* and a link at the bottom of the page to view the *View All Encoders page*. If an encoder has been assigned to the *Preset*, then you will also be presented with an *Edit link* next to the *View All Encoders link*.

Select Encoder

The *Select Encoder field* provides a drop-down menu, which presents the complete list of all encoders available on the encoder.

Select Encoder:

- None
- CIF_AVI
- CIF_R_350K
- CIF_R_768K
- CIF_W_350K
- CIF_W_768K
- MOB_R_56K
- MOB_W_50K

To assign an encoder select an encoder from the list and click the *Submit button*.

Select Encoder:

The Web page will update the **Preset A EZStream button** and report success in the form of a dialog box such as the one shown directly below.

Encoder Preset : A updated successfully

Encoder Preset A

This page allows setting the GoStream Encoder Presets. A preset is a quick way to select a specific Encoder. There are three presets on the front panel A, B and C. Click on the **A**, **B** or **C** buttons below or select from the menu to switch between each preset.

When an Encoder is assigned to a preset button, pressing the button on the GoStream panel will allow for quick easy starting or stopping of the encoder. Select an Encoder for the preset or select 'None' to deactivate the GoStream preset button. When no encoder assignment is made, pressing the GoStream button will show a message reminding you that no Encoder has been defined.

Select Encoder:

By clicking on the **B** and **C buttons** on the encoder graphic, you can assign encoders to those **EZStream buttons** in the same way.



NOTE: It is not possible to assign the same encoder to two **EZStream buttons** simultaneously. If an encoder is already assigned to a button and you assign it to another button, encoder will remove the association to the previous button in favor of the most current request.

View All Encoders

After assigning encoders to the **A**, **B**, and **C buttons**, the **Presets column** on the **All Encoders page** is update to reflect these changes. To view these changes, click the **All Encoders link** at the bottom of the page.



Edit Preset Encoder Profile

After assigning encoders to the **EZStream buttons**, you can access the encoder editing page by clicking the **edit button** at the bottom of the **Preset page**.

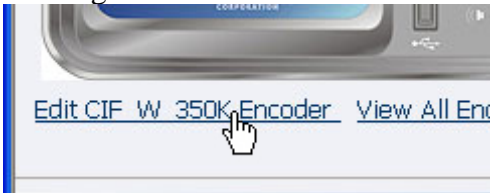

My GoStream

The *My GoStream* page provides details on *software versions*, *network name*, *serial number*, and *hard drive configurations*. Most of the data on this page is for informational purposes and cannot be altered. However, there are two fields that allow modifications. They are as follows:

- Computer Name
- Admin password



Computer Name

The *Computer Name field* contains the current network name for the Cisco Digital Media 1000. This is the same name that you typed into a Web browser to access the *Niagara SCX Web Interface*. You can change the *Computer Name* by clicking the *Click to change name link* next to this field.

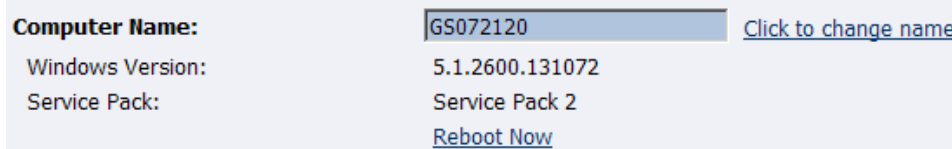

The screen will refresh and now the *Computer Name field* is an editable text field. Type in a new name for the encoder.

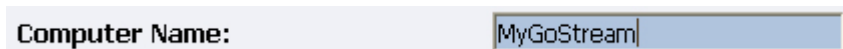

Next, click the *Submit button* at the bottom of the page.

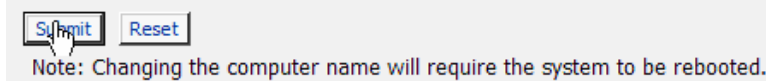

The page will refresh and you will be prompted to reboot the Encoder. Your changes will not take effect until the system is restarted.

Click the **Reboot Now link** to restart the system and apply the Computer Name change.

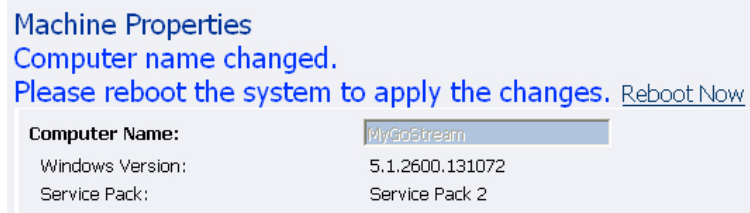

The screenshot shows a 'Machine Properties' dialog box with the following text: 'Computer name changed. Please reboot the system to apply the changes. Reboot Now'. Below this, there is a table of system information:

Computer Name:	MyGoStream
Windows Version:	5.1.2600.131072
Service Pack:	Service Pack 2

While the Encoder is restarting, the following message will appear in the Web Interface.

The Web service is currently not available. Please wait for the service to be restarted and returned to normal service. This page will automatically refresh.

In Progress... System Reboot **Friday, September 5, 2007, 6:00:42 p.m.**

NOTE: The restart process takes approximately two minutes to complete.

When Encoder has restarted, you will be returned to the **Login screen**.

NOTE: If you close your Web browser and later want to log into the **SCX Web Interface**, you will need to use the new computer name you created to access Encoder.

Cisco Digital Media 1000 Properties

The Encoder **Properties section** has two fields, those being the **User Name** and **Serial Number fields**. Only the **User Name field** allows modification, which changes the **User Password** from the factory default.

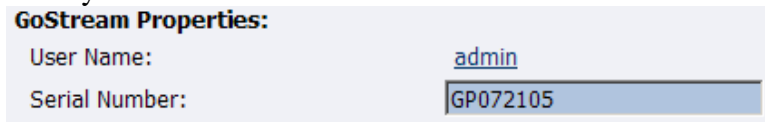

The screenshot shows a 'GoStream Properties' dialog box with the following fields:

User Name:	admin
Serial Number:	GP072105

Changing the Login Password from the Factory Default

Click the **admin link** in the **User Name field**. You will be presented with a new screen that allows you to change your login password for the **SCX Web Interface**.

NOTE: You cannot change the **User Name** for the **SCX Web Interface**.

Type in your current password in the *Password field* and then type in the new password in both the *New Password* and *Confirm New Password fields*.

NOTE: The *SCX Web Interface password* is case sensitive.

Change your password for the GoStream web login.



Change Your Password

User Name:

Password:

New Password:

Confirm New Password:

[Back to home page](#)

Then click the *Change Password button*. You will then be presented with the results in the form of a dialog box such as the one shown directly below.

Change your password for the GoStream web login.



[Password Changed successfully, click to login](#)

NOTE: You will need to log back into the Web Interface with your new password.

Restoring the Login Password to the Factory Default

If you have forgotten or lost your password, you can restore the default password by running the *Restore Encoder Factory Defaults option*. For more information, see *Restore Encoder Factory Defaults* in the *System Configuration section* in the following sections.

Cisco Digital Media 1000 Alerts

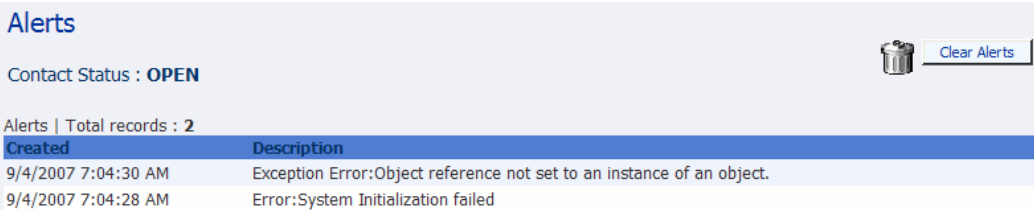

Alerts

Contact Status : OPEN

Alerts | Total records : 2

Created	Description
9/4/2007 7:04:30 AM	Exception Error:Object reference not set to an instance of an object.
9/4/2007 7:04:28 AM	Error:System Initialization failed

This page allows you to control how the encoder handles application alerts that may occur during streaming or other operations. The encoder can optionally send an email to multiple recipients and light the alarm light on the front panel of the encoder.

Email Alert

You can optionally send an email alert to specific email address in the event of an application alarm. Checking *Send Email* will enable this feature. You must specify the email address to which to send and your email server user name, password, and server name. For more information about

configuring Encoder to send email alerts, see the *System Configuration section* in the following sections.

Alarm Light

Checking the *Light Alarm box* will instruct the encoder to light the front panel alarm light.

Edit Alert Settings

To edit the settings for each alert listed, click the *Edit link* in the row of the alert you which to modify.

Once you have made your modifications to the alert settings, click the *Update link* to enter your settings and return to the Encoder *Alerts list*.

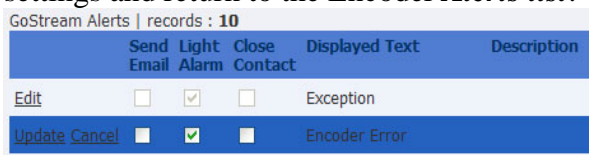

GoStream Alerts records : 10				
	Send Email	Light Alarm	Close Contact	Description
Edit	<input type="checkbox"/>	<input checked="" type="checkbox"/>	<input type="checkbox"/>	Exception
Update Cancel	<input type="checkbox"/>	<input checked="" type="checkbox"/>	<input type="checkbox"/>	Encoder Error

Please see the *The Help, or “i” Button, the Niagara SCX Web Interface, and their Alert Settings* later in this user guide.

Network Properties

The *Network Properties* page provides detailed information on the encoder's current network settings for the Network Interface Card (NIC). In the example below, the *Advanced Settings* on the *Primary WINS Server* and the *Secondary Wins Server* appear due to the Encoder system running on Windows® servers.

The screenshot shows the configuration page for a Secondary NIC. The network card is identified as 'Secondary NIC' with a description of 'Intel(R) PRO/1000 PM Network Connection - Packet Scheduler Miniport'. The IP configuration is set to 'Use the following IP information' with the following values: IP Address: 172.16.1.168, Subnet Mask: 255.255.255.0, Default Gateway: 172.16.1.251, Preferred DNS Server: 172.16.1.3, and Alternate DNS Server: 172.16.2.3. The Advanced Settings section shows a link 'CG072501', MAC Address: 00:60:E0:04:C5:D8, Primary WINS Server: 0.0.0.0, and Secondary WINS Server: 0.0.0.0. The Active Network Link is shown as a computer icon with a network cable. There are 'Submit' and 'Reset' buttons at the bottom.

Should the encoder system not be running on Windows servers, the screenshot below, or a similar screenshot, will appear.

The screenshot shows the configuration page for a Primary NIC. The network card is identified as 'Primary NIC' with a description of 'Intel(R) PRO/100 VE Network Connection - Packet Scheduler Miniport'. The IP configuration is set to 'Obtain an IP address automatically'. The Advanced Settings section shows a link 'GP072105', MAC Address: 00:60:E0:04:D8:46, Primary WINS Server, and Secondary WINS Server. The Active Network Link is shown as a computer icon with a network cable. There are 'Submit' and 'Reset' buttons at the bottom.

If the following screenshot appears, please note no Ethernet cable is attached from the encoder system into a server. Note the statement **Verify the network cable to enable network setting updates!** and the icon at the bottom of the screen indicating a disconnect.

Home Encoders Configuration Status Log Out

Verify the network cable to enable network setting updates!
(TCP/IP) Network Properties

Network Card(s) Secondary NIC
Description: Intel(R) PRO/100 M Network Connection - Packet Scheduler Miniport

Obtain an IP address automatically
 Use the following IP information

IP Address: 0.0.0.0
Subnet Mask:
Default Gateway:
Preferred DNS Server:
Alternate DNS Server:

Advanced Settings on GP072105
MAC Address: 00:60:E0:04:D8:47
Primary WINS Server:
Secondary WINS Server:
Active Network Link:

Submit Reset

Network Card(s)

Encoder has two network connections, a primary connection and a secondary connection. To view the current properties for each card, select the card you wish to view from the drop-down menu in the Network Card(s) field.

(TCP/IP) Network Properties

Network Card(s) Primary NIC
Description: Primary NIC
Secondary NIC

Advanced Settings (Network)



Advanced Settings provides the encoder *network name*, *MAC Address* and *server IP address settings*.

Advanced Settings on GP072105
MAC Address: 00:60:E0:04:D8:46
Primary WINS Server: 172.16.1.5
Secondary WINS Server: 172.16.1.12
Active Network Link:

Submit Reset

The encoder network name is a link. If you click this link, you will be directed to the **My Encoder page**. From this page you can change the encoder's *network name*. For more information, see the preceding section entitled **Computer Name**.

The Active Network Link: This field uses two icons to indicate whether the network interface card selected has a network connected.

Network Link Icon	Description
	The network link is detected.
	The network link is not detected.

System Configuration Settings

The *System Configuration Settings* page allows you to modify your encoder default system settings. You can configure email settings so that the encoder can send an email to predefined email addresses whenever the encoder encounters an alert condition. You can also customize the information that the encoder displays on its front panel when the system is idle.

This page also provides the ability to restore your encoder to its original factory disk image returning all of the system settings to their original state. Using the *Factory Restore option*, will remove all custom settings and takes approximately 10 minutes to complete.

Home Encoders Configuration Status Log Out

This page allows you to modify your GoStream default system settings.

Enter a valid email settings to have GoStream send emails for [alert conditions](#). Optionally select the information to show on the GoStream display when GoStream is idle. You can customize the idle screen text or use the default settings. [Restore GoStream Factory Defaults](#)

System Configuration Settings

Email Settings:

Send Emails To:

Email From:

Subject:

SMTP (Mail) Settings:

User Name:

Password:

SMTP Host: [Save and Send Test Email](#)

Idle Screen Information:

Cycle this information in the display when GoStream is idle.

Active IP Computer Name CPU
 Memory Hard Drive Temperature

Idle screen text:
Note: Each line in the display is 20 characters.

Line 1
 Line 2
 Line 3
 Line 4

***Default AV Folder:**

High Temperature Alert: degrees Celsius. (view [Alert Configuration](#))

Restore Encoder Factory Defaults

Click the *Restore Encoder Factory Defaults link* to start the process.

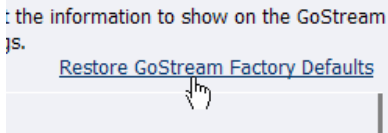

The next screen gives details of the process that you are about to execute and allows you the opportunity to cancel the process.

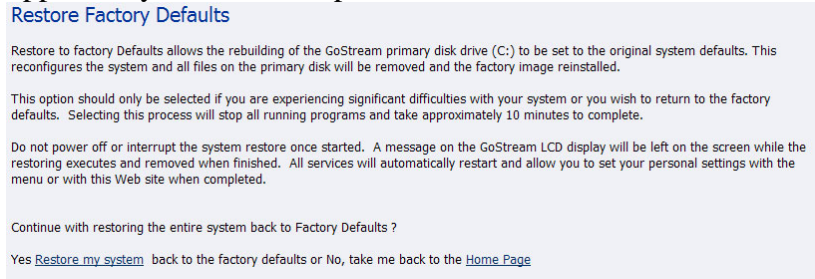

NOTE: Restore to Factory Defaults rebuilds the encoder primary disk drive (C:) with the original system image. All custom settings and any files saved to drive C will be lost. This process cannot be reversed but you can manually re-enter your custom settings once the encoder restore process is completed.

NOTE: The default directory for saving your audio and video files is D:\AV Files\. When using the *Restore to Factory Defaults option*, only drive C: is re-imaged. All files and folders on drive D: are preserved. To ensure your personal files are not removed, always use the default directory – drive D – for storage of personal files.

Email Settings

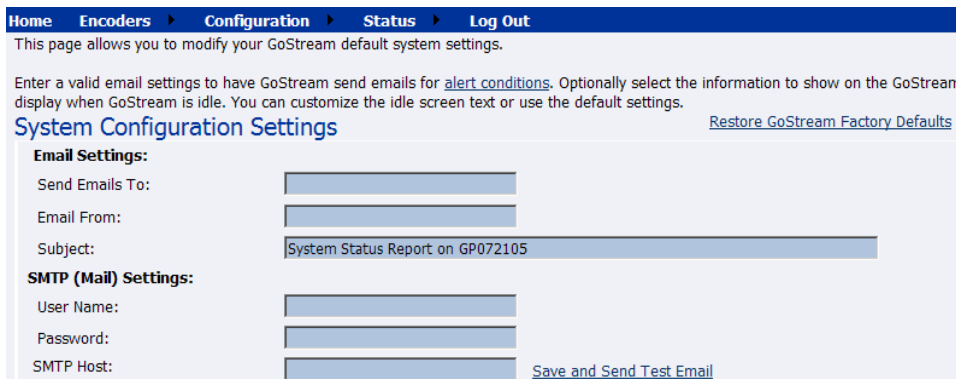

If you are unfamiliar with setting up an SMTP email account for sending email, please contact your network administrator for assistance.

To configure the encoder *email settings*, you will need to enter the following information:

- The address to which to send the email (separate multiple email address with a comma)
- A valid email address from which the email comes
- A subject line for your email alert – required
- The SMTP (mail server) settings
 - User name for server access
 - Password (if required)
 - The name of the SMTP server

NOTE: For security purposes, the password for your account will not be display once it has been entered into the *Encoder settings*. Even though this field will appear blank after you click the *Submit button*, the password information has been retained.

NOTE: If you change any information on this page, you will need to re-enter your SMTP password before clicking the *Submit button*. Not doing so will overwrite the previously entered password with a blank entry.

Once you have entered the information above, click the *Submit button* to save your changes.



You can then test your settings by clicking the *Save and Send Test Email link*. The page will report if the email was successfully sent or if it failed to send.

SMTP (Mail) Settings:

User Name:	<input type="text"/>
Password:	<input type="password"/>
SMTP Host:	<input type="text"/>

[Save and Send Test Email](#)

Idle Screen Information

Refer to the LCD Character Chart in the Appendix for a list of characters supported by the encoder LCD display.

This section allows you to modify the information that is displayed on the front panel display of the encoder LCD.

Check the boxes next to the various information that you want displayed. This information is cycled as the LCD display alternates between *status information* and *encoder information*.

At the top of the LCD idle screen is the default message *System is Ready*. You can customize this message.

Idle Screen Information:

Cycle this information in the display when GoStream is idle.

<input checked="" type="checkbox"/> Active IP	<input checked="" type="checkbox"/> Computer Name	<input checked="" type="checkbox"/> CPU
<input checked="" type="checkbox"/> Memory	<input checked="" type="checkbox"/> Hard Drive	<input checked="" type="checkbox"/> Temperature

Idle screen text:
Note: Each line in the display is 20 characters.

GoStream is Ready	Line 1
	Line 2
	Line 3
	Line 4

Once you have entered the information above, click the **Submit button** to save your changes.



Default Directory Setting

NOTE: We strongly recommended that you do not alter this default setting unless you understand the risk of saving your files to a directory not located on drive D. If you save your files to another drive on the encoder, these files could be deleted if you use the *Restore to Encoder Factory Defaults feature*.

NOTE: Only drive D on the encoder has available storage to save your files. This drive has approximately 30 Gigabytes of storage capacity.

NOTE: Drives C:, E, and F: are used strictly for encoder operational programs. Any modifications to these drives can permanently damage your system and void your warranty.

The Default AV Folder is the directory that encoder stores AV files created whenever you select the *Save to File option* in an encoder profile. Refer to the *Save to File option* under *AVI, Flash, Real*, and the *Windows Media Encoder Properties section* for information on setting an encoder profile to create an AV file.

***Default AV Folder:**

High Temperature Alert

You can enable an alert if the encoder reaches a predefined maximum temperature level. To set the level, select the drop-down menu.

The *Alert Configuration links* to the *Encoder Alerts page*. Refer to the previous sections for information on setting the *Encoder Alerts*.

High Temperature Alert: degrees Celsius. (view [Alert Configuration](#))

View Activity Log

The *Activity Log* records all operational activity such as general activities that include starting an encoder or stopping an encoder. The *Activity Log* includes activities that generate warnings and errors.

You can view these activities by filters showing only the *General activities*, the *Warning activities* or the *Error activities*.

Click the *Clear Activity Log button* to remove all entries.

NOTE: Once an activity has been cleared from the log, it cannot be retrieved.

Activity Log

View Activity Types: 

Activity Log | Total records : 2 

Created	Type	Description
5/22/2006 6:41:33 AM	General	CIF_W_350K Stopped
5/22/2006 6:41:31 AM	General	CIF_W_350K Stopping

View Alerts

All alerts defined on the *Encoder Alerts page* are logged on the *View Alerts page* when those alerts occur. Once a user has cleared the alert using the *Help, or “i,” button* on the front panel of the Encoder, the alert is cleared from the *View Alerts log page*.

Alerts | No GoStream alerts at this time.

Alternatively, the encoder system informs you of an alert when the *Alarm Indicator Light* on the front panel of the system turns red. When this occurs on the encoder system, to determine what the alert is, you must press the *Help, or “i,” button*, which will cycle the alert occurring.

Please see the *The Help, or “i,” button, the Niagara SCX Web Interface, and their Alert Settings section* set forth later in this document.

The Help, or “i” Button, the Niagara SCX Web Interface, and Alert Settings

The *Help button, or “i,” button*, on the front panel of the encoder, as stated above, allows you to view the alerts currently occurring in the encoder. Directly below is a diagram of the *Help, or “i,” button*, which is located on the front panel of the encoder. The *Help, or “i,” button* allows you to view alerts of many types that can occur on the encoder based on the types of alerts you request of the system to notify you.

NOTE: An alert is not necessarily an indication of a fault occurring. You might want to be made aware of changes in the system, which have nothing to do with errors that could occur on a Cisco Digital Media 1000.

For example, you might want a notification set to signal you as to when an encoder has started or when as to when an encoder has stopped.

To view alerts occurring, you have a choice to view the alerts through use of the Cisco Digital Media 1000 or the Niagara SCX Web Interface. If you use the Web Interface, the following is the first page of the Niagara SCX Web Interface you will see to **View Alerts**.

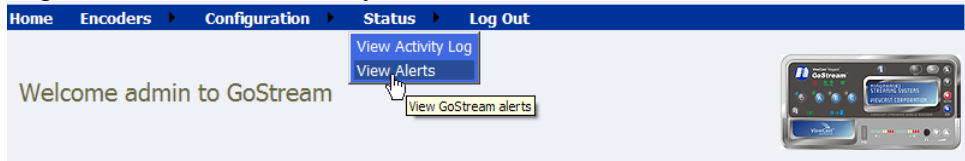

Any alerts will appear on the Niagara SCX Web Interface, as follows:

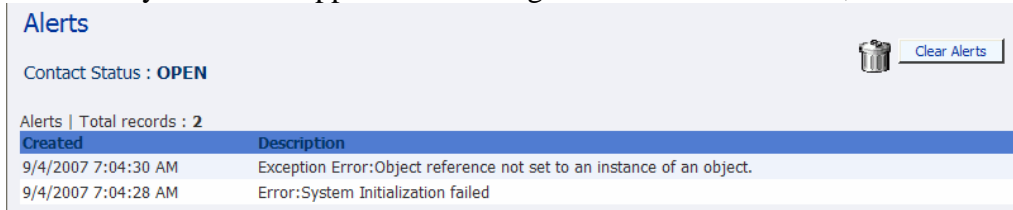

Alerts will be available for viewing on the Niagara SCX Web Interface until you clear them by clicking on the **Clear Alerts button**.



To see any alerts, you must have previously set the system to notify you of the alerts by choosing **GoStream Alerts**.

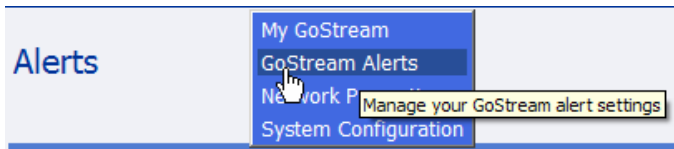

This will bring you to the following screen. To set the alerts for which you want to be notified, you must click a notification method next to the type of alert. You can be notified of alerts, such as the ones indicated below, i.e., exceptions, encoder errors, encoders started, encoders stopped, alarm tests, SCX service stopped, SCX service started, and high temperature alerts, in addition to other alerts you set yourself.

Alerts
 This page allows you to control how GoStream handles application alerts that may occur during streaming or normal operations. GoStream can optionally send a single email or close a hardware contact on the dual dock for each condition selected below. Click to see the GoStream [Email address](#).

GoStream Alerts | records : 10

	Send Email	Light Alarm	Close Contact	Displayed Text	Description
Edit	<input type="checkbox"/>	<input checked="" type="checkbox"/>	<input type="checkbox"/>	Exception	
Edit	<input type="checkbox"/>	<input checked="" type="checkbox"/>	<input type="checkbox"/>	Encoder Error	
Edit	<input type="checkbox"/>	<input checked="" type="checkbox"/>	<input type="checkbox"/>	Undefined	
Edit	<input type="checkbox"/>	<input type="checkbox"/>	<input type="checkbox"/>	Encoder Started	
Edit	<input type="checkbox"/>	<input type="checkbox"/>	<input type="checkbox"/>	Encoder Stopped	
Edit	<input type="checkbox"/>	<input checked="" type="checkbox"/>	<input type="checkbox"/>	AlarmTest	
Edit	<input type="checkbox"/>	<input checked="" type="checkbox"/>	<input type="checkbox"/>	SCX service stopped	
Edit	<input type="checkbox"/>	<input type="checkbox"/>	<input type="checkbox"/>	SCX service started	
Edit	<input type="checkbox"/>	<input type="checkbox"/>	<input type="checkbox"/>	Warning	
Edit	<input type="checkbox"/>	<input checked="" type="checkbox"/>	<input type="checkbox"/>	High Temperature!	

To set your *System Configuration Settings* as to how you want to receive your alerts, please see the figure below. Click on *System Configuration*.

The screenshot shows a navigation bar with the following items: Home, Encoders, Configuration, Status, and Log Out. The 'Configuration' menu is expanded, showing sub-items: My GoStream, GoStream Alerts, Network Properties, and System Configuration. The 'System Configuration' item is highlighted with a mouse cursor, and a tooltip below it reads 'Manage your GoStream system settings'. The background text of the page is partially visible, including 'This page allows you to n...', 'default system settings.', 'Enter a valid email setting...', 'nd emails for alert condition', and 'display when GoStream is... the idle screen text or use'.

See your Network Administrator to set your email configurations if you decide to receive email alerts.

Alternatively, the encoder informs you of an alert when the **Alarm Indicator Light** on the front panel of the system turns red. When this occurs on the encoder, to determine what the alerts are, you must press the **Help, or “i,” button**, which will cycle the alerts occurring. The following screen showing an alert might look as follows:



Alerts will cycle the information in the display when the encoder is idle until all alerts have been identified, then the screen will return to its normal system cycling, and the alerts will not be shown again on the encoder.