









Cisco GainStar Line Extender
Module and Strand Housings with
Integrated Reverse Amplifier
Module
Installation and Operation Guide

For Your Safety

Explanation of Warning and Caution Icons

Avoid personal injury and product damage! Do not proceed beyond any symbol until you fully understand the indicated conditions.

The following warning and caution icons alert you to important information about the safe operation of this product:

-  You may find this symbol in the document that accompanies this product. This symbol indicates important operating or maintenance instructions.
-  You may find this symbol affixed to the product. This symbol indicates a live terminal where a dangerous voltage may be present; the tip of the flash points to the terminal device.
-  You may find this symbol affixed to the product. This symbol indicates a protective ground terminal.
-  You may find this symbol affixed to the product. This symbol indicates a chassis terminal (normally used for equipotential bonding).
-  You may find this symbol affixed to the product. This symbol warns of a potentially hot surface.
-  You may find this symbol affixed to the product and in this document. This symbol indicates an infrared laser that transmits intensity-modulated light and emits invisible laser radiation or an LED that transmits intensity-modulated light.

Important

Please read this entire guide. If this guide provides installation or operation instructions, give particular attention to all safety statements included in this guide.

Notices

Trademark Acknowledgments

Cisco and the Cisco logo are trademarks or registered trademarks of Cisco and/or its affiliates in the U.S. and other countries. To view a list of cisco trademarks, go to this URL: <http://www.cisco.com/go/trademarks>.

Third party trademarks mentioned are the property of their respective owners.

The use of the word partner does not imply a partnership relationship between Cisco and any other company. (1110R)

Publication Disclaimer

Cisco Systems, Inc. assumes no responsibility for errors or omissions that may appear in this publication. We reserve the right to change this publication at any time without notice. This document is not to be construed as conferring by implication, estoppel, or otherwise any license or right under any copyright or patent, whether or not the use of any information in this document employs an invention claimed in any existing or later issued patent.

Copyright

© 2010, 2014 Cisco and/or its affiliates. All rights reserved. Printed in the United States of America.

Information in this publication is subject to change without notice. No part of this publication may be reproduced or transmitted in any form, by photocopy, microfilm, xerography, or any other means, or incorporated into any information retrieval system, electronic or mechanical, for any purpose, without the express permission of Cisco Systems, Inc.

Contents

Important Safety Instructions vii

Introduction 1

| | |
|---|---|
| Description..... | 3 |
| GainStar Line Extender Characteristics | 3 |
| Power Supply | 3 |
| Input and Output Ports..... | 3 |
| Configuration | 4 |
| Test Points | 4 |
| AC Shunt Power Directors | 4 |
| GainStar Line Extender Ordering Information | 4 |
| Accessories | 5 |
| Customer Installable Accessories for the GainStar Line Extender | 5 |
| GainStar Line Extender Test Points..... | 6 |
| GainStar Line Extender Accessories..... | 7 |
| Block Diagrams | 8 |

Installation and Configuration 9

| | |
|--|----|
| Before You Begin..... | 10 |
| Required Tools | 10 |
| Torque Specifications | 10 |
| GainStar Line Extender Module Cover | 11 |
| Housing Dimensions | 12 |
| Opening the Line Extender Housing | 13 |
| To Open the Line Extender Housing | 13 |
| Attaching the Coaxial Connectors..... | 14 |
| To Prepare the Line Extender Module for Connector Installation | 14 |
| To Connect the RF Connector Pin | 16 |
| Installing the Housing..... | 17 |
| To Install the Housing on a Strand (Aerial) | 17 |
| To Install the Housing in a Pedestal..... | 18 |
| Installing the Accessories..... | 19 |
| To Install the Attenuator Pads | 19 |
| To Install the Equalizers..... | 20 |
| To Set up RF Output Port | 21 |
| System Power | 23 |
| System Power (44 to 90 VAC) | 23 |
| AC Shunt..... | 24 |
| System Power (100 to 240 VAC) | 25 |

| | |
|--|----|
| Closing the Line Extender Housing | 26 |
| To Close the Line Extender Housing | 26 |
| Torquing Sequence | 26 |

Balancing and Setup **27**

| | |
|---|----|
| Preparing for Forward Path Balancing | 28 |
| Before You Begin..... | 28 |
| Balancing the Forward Path | 29 |
| Introduction..... | 29 |
| To Verify the Forward Input Level | 29 |
| To Determine the Output Tilt | 30 |
| To Set Up the Output Tilt | 31 |
| To Set Up the Forward Output Level | 32 |
| Balancing the Reverse Path | 34 |
| Introduction..... | 34 |
| To Set Up the Reverse Input Level..... | 34 |
| To Set Up the Reverse Output Level..... | 35 |
| To Set Up the Equalizer Values for Reverse Path | 36 |

Troubleshooting **39**

| | |
|---|----|
| Equipment..... | 40 |
| No Forward RF Signal..... | 41 |
| No Forward RF Signal Troubleshooting Table..... | 41 |
| Low or Degraded Forward RF Signal | 42 |
| Low or Degraded Forward RF Signal Troubleshooting Table | 42 |
| No Reverse RF Signal | 43 |
| No Reverse RF Signal Troubleshooting Table | 43 |
| Low or Degraded Reverse RF Signal | 44 |
| Low or Degraded Reverse RF Signal Troubleshooting Table | 44 |
| No Power Supply | 46 |
| No Power Supply..... | 46 |
| Boot Color Table..... | 47 |

Customer Support Information **49**

Appendix A Technical Information **51**

| | |
|--|----|
| Forward Cable Equalizer | 52 |
| 1 GHz Forward Cable Equalizer Loss Table | 52 |
| Forward Inverse Cable Equalizer | 53 |
| 105 MHz Inverse Equalizer Loss Table..... | 53 |
| Reverse Cable Equalizer | 54 |
| 85 MHz Reverse Cable Equalizer Loss Table..... | 54 |

GainStar Line Extender Accessories Part Numbers..... 56

Important Safety Instructions

Read and Retain Instructions

Carefully read all safety and operating instructions before operating this equipment, and retain them for future reference.

Follow Instructions and Heed Warnings

Follow all operating and use instructions. Pay attention to all warnings and cautions in the operating instructions, as well as those that are affixed to this equipment.

Terminology

The terms defined below are used in this document. The definitions given are based on those found in safety standards.

Service Personnel - The term *service personnel* applies to trained and qualified individuals who are allowed to install, replace, or service electrical equipment. The service personnel are expected to use their experience and technical skills to avoid possible injury to themselves and others due to hazards that exist in service and restricted access areas.

User and Operator - The terms *user* and *operator* apply to persons other than service personnel.

Ground(ing) and Earth(ing) - The terms *ground(ing)* and *earth(ing)* are synonymous. This document uses *ground(ing)* for clarity, but it can be interpreted as having the same meaning as *earth(ing)*.

Electric Shock Hazard

This equipment meets applicable safety standards.



WARNING:

To reduce risk of electric shock, perform only the instructions that are included in the operating instructions. Refer all servicing to qualified service personnel only.

Electric shock can cause personal injury or even death. Avoid direct contact with dangerous voltages at all times.

Know the following safety warnings and guidelines:

- Only qualified service personnel are allowed to perform equipment installation or replacement.
- Only qualified service personnel are allowed to remove chassis covers and access any of the components inside the chassis.

Equipment Placement



WARNING:

Avoid personal injury and damage to this equipment. An unstable mounting surface may cause this equipment to fall.

To protect against equipment damage or injury to personnel, comply with the following:

- Install this equipment in a restricted access location (access restricted to service personnel).
- Make sure the mounting surface or rack is stable and can support the size and weight of this equipment.

Strand (Aerial) Installation



CAUTION:

Be aware of the size and weight of strand-mounted equipment during the installation operation.

Ensure that the strand can safely support the equipment's weight.

Pedestal, Service Closet, Equipment Room or Underground Vault Installation



WARNING:

Avoid the possibility of personal injury. Ensure proper handling/lifting techniques are employed when working in confined spaces with heavy equipment.

- Ensure this equipment is securely fastened to the mounting surface or rack where necessary to protect against damage due to any disturbance and subsequent fall.
- Ensure the mounting surface or rack is appropriately anchored according to manufacturer's specifications.
- Ensure the installation site meets the ventilation requirements given in the equipment's data sheet to avoid the possibility of equipment overheating.
- Ensure the installation site and operating environment is compatible with the equipment's International Protection (IP) rating specified in the equipment's data sheet.

Connecting to Utility AC Power

Important: If this equipment is a Class I equipment, it must be grounded.

- If this equipment plugs into an outlet, the outlet must be near this equipment, and must be easily accessible.

- Connect this equipment only to the power sources that are identified on the equipment-rating label, which is normally located close to the power inlet connector(s).
- This equipment may have two power sources. Be sure to disconnect all power sources before working on this equipment.
- If this equipment **does not** have a main power switch, the power cord connector serves as the disconnect device.
- Always pull on the plug or the connector to disconnect a cable. Never pull on the cable itself.

Connection to Network Power Sources

Refer to this equipment's specific installation instructions in this manual or in companion manuals in this series for connection to network ferro-resonant AC power sources.

AC Power Shunts

AC power shunts may be provided with this equipment.

Important: The power shunts (where provided) must be removed before installing modules into a powered housing. With the shunts removed, power surge to the components and RF-connectors is reduced.



CAUTION:

RF connectors and housing seizure assemblies can be damaged if shunts are not removed from the equipment before installing or removing modules from the housing.

Grounding (Utility AC Powered Equipment in Pedestals, Service Closets, etc.)

This section provides instructions for verifying that the equipment is properly grounded.

Safety Plugs (USA Only)

This equipment is equipped with either a 3-terminal (grounding-type) safety plug or a 2-terminal (polarized) safety plug. The wide blade or the third terminal is provided for safety. Do not defeat the safety purpose of the grounding-type or polarized safety plug.

To properly ground this equipment, follow these safety guidelines:

- **Grounding-Type Plug** - For a 3-terminal plug (one terminal on this plug is a protective grounding pin), insert the plug into a grounded mains, 3-terminal outlet.

Note: This plug fits only one way. If this plug cannot be fully inserted into the outlet, contact an electrician to replace the obsolete 3-terminal outlet.

Important Safety Instructions

- **Polarized Plug** - For a 2-terminal plug (a polarized plug with one wide blade and one narrow blade), insert the plug into a polarized mains, 2-terminal outlet in which one socket is wider than the other.

Note: If this plug cannot be fully inserted into the outlet, try reversing the plug. If the plug still fails to fit, contact an electrician to replace the obsolete 2-terminal outlet.

Grounding Terminal

If this equipment is equipped with an external grounding terminal, attach one end of an 18-gauge wire (or larger) to the grounding terminal; then, attach the other end of the wire to a ground, such as a grounded equipment rack.

Safety Plugs (European Union)

- **Class I Mains Powered Equipment** – Provided with a 3-terminal AC inlet and requires connection to a 3-terminal mains supply outlet via a 3-terminal power cord for proper connection to the protective ground.

Note: The equipotential bonding terminal provided on some equipment is not designed to function as a protective ground connection.

- **Class II Mains Powered Equipment** – Provided with a 2-terminal AC inlet that may be connected by a 2-terminal power cord to the mains supply outlet. No connection to the protective ground is required as this class of equipment is provided with double or reinforced and/or supplementary insulation in addition to the basic insulation provided in Class I equipment.

Note: Class II equipment, which is subject to EN 50083-1, is provided with a chassis mounted equipotential bonding terminal. See the section titled **Equipotential Bonding** for connection instructions.

Equipotential Bonding

If this equipment is equipped with an external chassis terminal marked with the IEC 60417-5020 chassis icon () , the installer should refer to CENELEC standard EN 50083-1 or IEC standard IEC 60728-11 for correct equipotential bonding connection instructions.

General Servicing Precautions



WARNING:

Avoid electric shock! Opening or removing this equipment's cover may expose you to dangerous voltages.



CAUTION:

These servicing precautions are for the guidance of qualified service personnel only. To reduce the risk of electric shock, do not perform any servicing other than that contained in the operating instructions unless you are qualified to do so. Refer all servicing to qualified service personnel.

Be aware of the following general precautions and guidelines:

- **Servicing** - Servicing is required when this equipment has been damaged in any way, such as power supply cord or plug is damaged, liquid has been spilled or objects have fallen into this equipment, this equipment has been exposed to rain or moisture, does not operate normally, or has been dropped.
- **Wristwatch and Jewelry** - For personal safety and to avoid damage of this equipment during service and repair, do not wear electrically conducting objects such as a wristwatch or jewelry.
- **Lightning** - Do not work on this equipment, or connect or disconnect cables, during periods of lightning.
- **Labels** - Do not remove any warning labels. Replace damaged or illegible warning labels with new ones.
- **Covers** - Do not open the cover of this equipment and attempt service unless instructed to do so in the instructions. Refer all servicing to qualified service personnel only.
- **Moisture** - Do not allow moisture to enter this equipment.
- **Cleaning** - Use a damp cloth for cleaning.
- **Safety Checks** - After service, assemble this equipment and perform safety checks to ensure it is safe to use before putting it back into operation.

Electrostatic Discharge

Electrostatic discharge (ESD) results from the static electricity buildup on the human body and other objects. This static discharge can degrade components and cause failures.

Take the following precautions against electrostatic discharge:

- Use an anti-static bench mat and a wrist strap or ankle strap designed to safely ground ESD potentials through a resistive element.
- Keep components in their anti-static packaging until installed.
- Avoid touching electronic components when installing a module.

Fuse Replacement

To replace a fuse, comply with the following:

- Disconnect the power before changing fuses.
- Identify and clear the condition that caused the original fuse failure.
- Always use a fuse of the correct type and rating. The correct type and rating are indicated on this equipment.

Important Safety Instructions

Batteries

This product may contain batteries. Special instructions apply regarding the safe use and disposal of batteries:

Safety

- Insert batteries correctly. There may be a risk of explosion if the batteries are incorrectly inserted.
- Do not attempt to recharge 'disposable' or 'non-reusable' batteries.
- Please follow instructions provided for charging 'rechargeable' batteries.
- Replace batteries with the same or equivalent type recommended by manufacturer.
- Do not expose batteries to temperatures above 100°C (212°F).

Disposal

- The batteries may contain substances that could be harmful to the environment
- Recycle or dispose of batteries in accordance with the battery manufacturer's instructions and local/national disposal and recycling regulations.



廢電池請回收

- The batteries may contain perchlorate, a known hazardous substance, so special handling and disposal of this product might be necessary. For more information about perchlorate and best management practices for perchlorate-containing substance, see www.dtsc.ca.gov/hazardouswaste/perchlorate.

Modifications

This equipment has been designed and tested to comply with applicable safety, laser safety, and EMC regulations, codes, and standards to ensure safe operation in its intended environment. Refer to this equipment's data sheet for details about regulatory compliance approvals.

Do not make modifications to this equipment. Any changes or modifications could void the user's authority to operate this equipment.

Modifications have the potential to degrade the level of protection built into this equipment, putting people and property at risk of injury or damage. Those persons making any modifications expose themselves to the penalties arising from proven non-compliance with regulatory requirements and to civil litigation for compensation in respect of consequential damages or injury.

Accessories

Use only attachments or accessories specified by the manufacturer.

Electromagnetic Compatibility Regulatory Requirements

This equipment meets applicable electromagnetic compatibility (EMC) regulatory requirements. Refer to this equipment's data sheet for details about regulatory compliance approvals. EMC performance is dependent upon the use of correctly shielded cables of good quality for all external connections, except the power source, when installing this equipment.

- Ensure compliance with cable/connector specifications and associated installation instructions where given elsewhere in this manual.

EMC Compliance Statements

Where this equipment is subject to USA FCC and/or Industry Canada rules, the following statements apply:

FCC Statement for Class A Equipment

This equipment has been tested and found to comply with the limits for a Class A digital device, pursuant to Part 15 of the FCC Rules. These limits are designed to provide reasonable protection against harmful interference when this equipment is operated in a commercial environment.

This equipment generates, uses, and can radiate radio frequency energy and, if not installed and used in accordance with the instruction manual, may cause harmful interference to radio communications. Operation of this equipment in a residential area is likely to cause harmful interference in which case users will be required to correct the interference at their own expense.

Industry Canada - Industrie Canadienne Statement

This apparatus complies with Canadian ICES-003.
Cet appareil est conforme à la norme NMB-003 du Canada.

GENELEC/CISPR Statement with Respect to Class A Information Technology Equipment

This is a Class A equipment. In a domestic environment this equipment may cause radio interference in which case the user may be required to take adequate measures.

1

Introduction

Overview

The GainStar Line Extender Platform addresses the needs of today's broadband networks, provides superior performance and reliability combined with a user-friendly layout.

This chapter introduces the GainStar Line Extender with Integrated Reverse Amplifier Module and describes its main components, configuration options, and accessories.

Purpose

This guide provides instructions for installing, configuring, setting up, and troubleshooting the GainStar Line Extender with Integrated Reverse Amplifier Module.

Who Should Use This Document

This document is intended for authorized service personnel who have experience working with similar equipment. The service personnel should have appropriate background and knowledge to complete the procedures described in this document.

Qualified Personnel



WARNING:

Allow only qualified and skilled personnel to install, operate, maintain, and service this product. Otherwise, personal injury or equipment damage may occur.

Only appropriately qualified and skilled personnel should attempt to install, operate, maintain, and service this product.

Scope

This guide discusses the following topics:

- Description of the GainStar Line Extender with Integrated Reverse Amplifier Module
- Installing and Configuring the GainStar Line Extender with Integrated Reverse Amplifier Module
- Balancing and Setup of the GainStar Line Extender with Integrated Reverse Amplifier Module Forward and Reverse Signal Paths
- Troubleshooting the GainStar Line Extender with Integrated Reverse Amplifier Module
- Customer Support Information
- Description of the Configuration Options and Accessories

Document Version

This is the third release of this guide.

In This Chapter

| | |
|------------------------|---|
| ■ Description..... | 3 |
| ■ Accessories..... | 5 |
| ■ Block Diagrams | 8 |

Description

The GainStar Line Extender is available in the following forward bandwidths.

- 1 GHz

The GainStar Line Extender is available in the following reverse/forward path splits.

- 85/105 MHz

The GainStar Line Extender is composed of a base and a lid. The base houses the RF mainboard, the power supply, and also contains the Line Extender cover.

The following chapters provide a detail description of the GainStar Line Extender components.

GainStar 85/105 Line Extender Characteristics

The GainStar Line Extender has the following characteristics.

- Can be set up for 1 GHz performance
- Selectable single or dual outputs with the onboard signal director
- Standard plug-in attenuators are used to adjust the gain and equalization settings
- Surge-resistant circuitry ensures resistance to high voltage transients (6 kV)
- Thermal RF control minimizes gain movement over temperature
- 10 A current capacity (steady state) and 15 A surge survivability
- Outdoor housing is IP68 dustproof and watertight
- Strand and pedestal mount housing configurations are available
- All ports accept PG11 connectors or 5/8" connectors using provided adapters
- RoHS 6/6 compliant

Power Supply

The available input power voltage for the GainStar Line Extender is 44 VAC to 90 VAC or 100 VAC to 240 VAC.

Input and Output Ports

The GainStar Line Extender has one input port and one or two output ports. The number of output ports is determined by the signal director or directional coupler.

Configuration

The GainStar Line Extender is configured with the following items:

- Forward Interstage Attenuator
- Forward Output Equalizer with Attenuator
- Forward Output Attenuator
- Signal Director or Directional Coupler
- Reverse Equalizer with Attenuator (Not included in forward only configuration)

Test Points

There are four RF test points on the GainStar Line Extender.

AC Shunt Power Directors

The GainStar Line Extender has three AC shunt power directors located near the ports of the GainStar Line Extender. These power directors are used to direct AC current to and from the GainStar Line Extender input and output ports.

GainStar Line Extender Ordering Information

The GainStar Line Extender can be ordered by accessing the Cisco Commerce Workspace tool at <https://cisco-apps.cisco.com/cisco/psn/commerce>. Please consult with your Account Representative, Customer Service Representative, or System Engineer to determine the best configuration for your particular application.

Accessories

Customer Installable Accessories for the GainStar Line Extender

The following table lists the customer installable accessories and their part numbers.

Note: All GainStar Line Extender accessories are unique to the GainStar product line.

| Accessory | Part Number | Quantity |
|-------------------------------|--|---|
| Attenuator Pad | 4036021 (0 dB) through 4036041 (20 dB), 0 dB through 20 dB in 1 dB increments | 1 required for forward input 1 required for reverse input (Not included in forward only configuration) 1 required for reverse output (Not included in forward only configuration) |
| Forward Cable EQ 1 GHz | 4034453, 0 to 4 dB 4034454, 5 to 9 dB 4034455, 10 to 14 dB | 1 required for forward input; 1 pad also required and plugged into EQ |
| Forward Inverse EQ 105 MHz | GS-FIEQ-105-00-04, 0 to 4 dB GS-FIEQ-105-05-09, 5 to 9 dB GS-FIEQ-105-10-14, 10 to 14 dB | |
| Reverse Cable EQ 85 MHz | GS-REQ-85-00-05, 0 to 5 dB GS-REQ-85-06-10, 6 to 10 dB | 0 to 5 dB EQ (GS-REQ-85-00-05) and 0 dB pad (4036021) are provided - other values must be ordered. (Not included in forward only configuration) |

When upgrading from forward only to a forward and reverse configuration, the Reverse EQ with Pad, Reverse input Pad, and Reverse output Pad accessories are required in GainStar Line Extender.

GainStar Line Extender Test Points

The following diagram shows the GainStar Line Extender module test points.

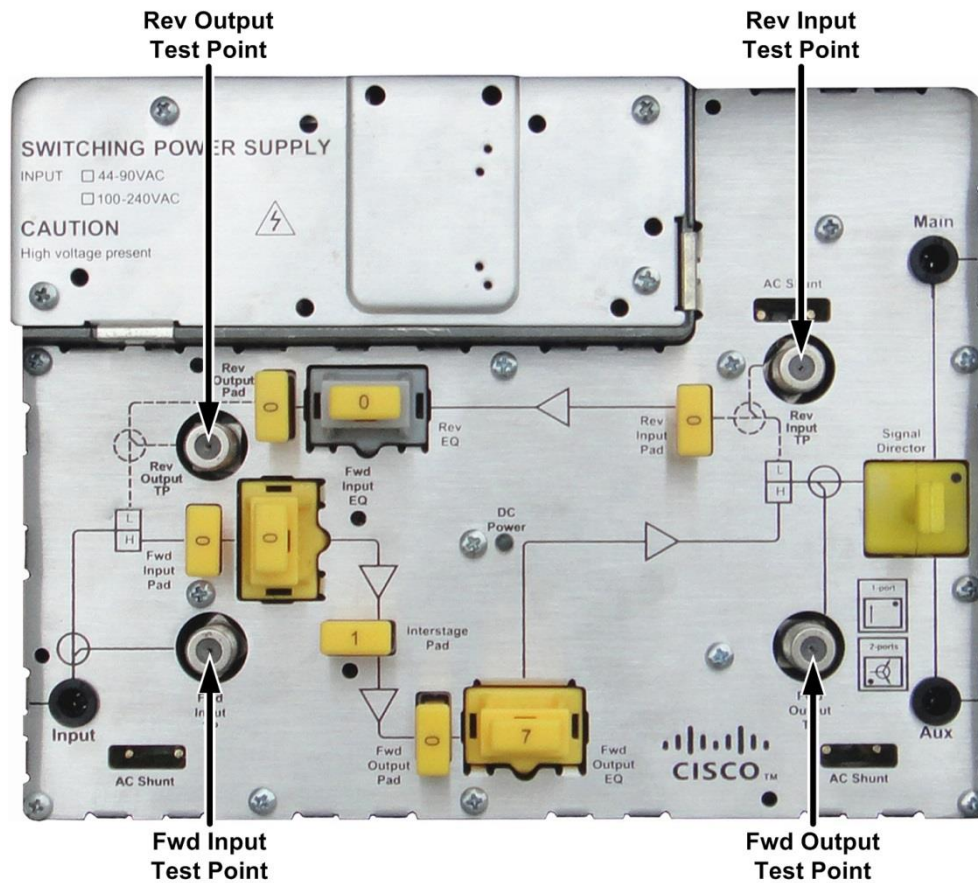

Note:

- The Forward input RF test point attenuates the forward input signal by 20 dB.
- The Reverse output RF test point attenuates the reverse output signal by 20 dB.
- If the signal director is installed, the Forward output RF test point attenuates the forward output signal by 20 dB (single output) or 16.5 dB (dual outputs), and the Reverse input RF test point attenuates the reverse input signal by 20 dB (single input) or 23.5 dB (dual inputs).
- If the DC8 directional coupler is installed, the Forward output RF test point attenuates the forward output signal by 20 dB (single output) or 12.2 dB (Aux port output) /18.0 dB (Main port output), and the Reverse input RF test point attenuates the reverse input signal by 20 dB (single input) or 28.4 dB (Aux port input) /21.8 dB (Main port input).
- If the DC12 directional coupler is installed, the Forward output RF test point attenuates the forward output signal by 20 dB (single output) or 8 dB (Aux port output) /18.5 dB (Main port output), and the Reverse input RF test point attenuates the reverse input signal by 20 dB (single input) or 32.6 dB (Aux port input) /21.0 dB (Main port input).

GainStar Line Extender Accessories

The following diagram shows the accessory locations for the GainStar Line Extender module.

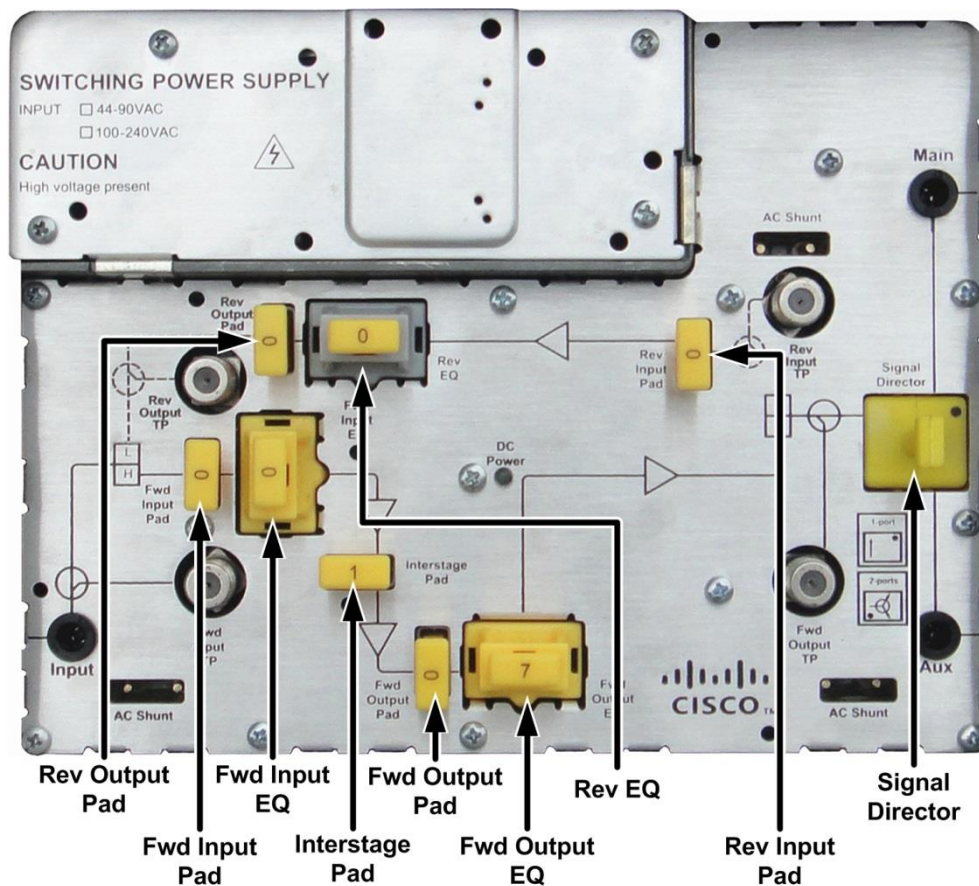

Block Diagrams

The following block diagram shows the forward and reverse path of the GainStar Line Extender.

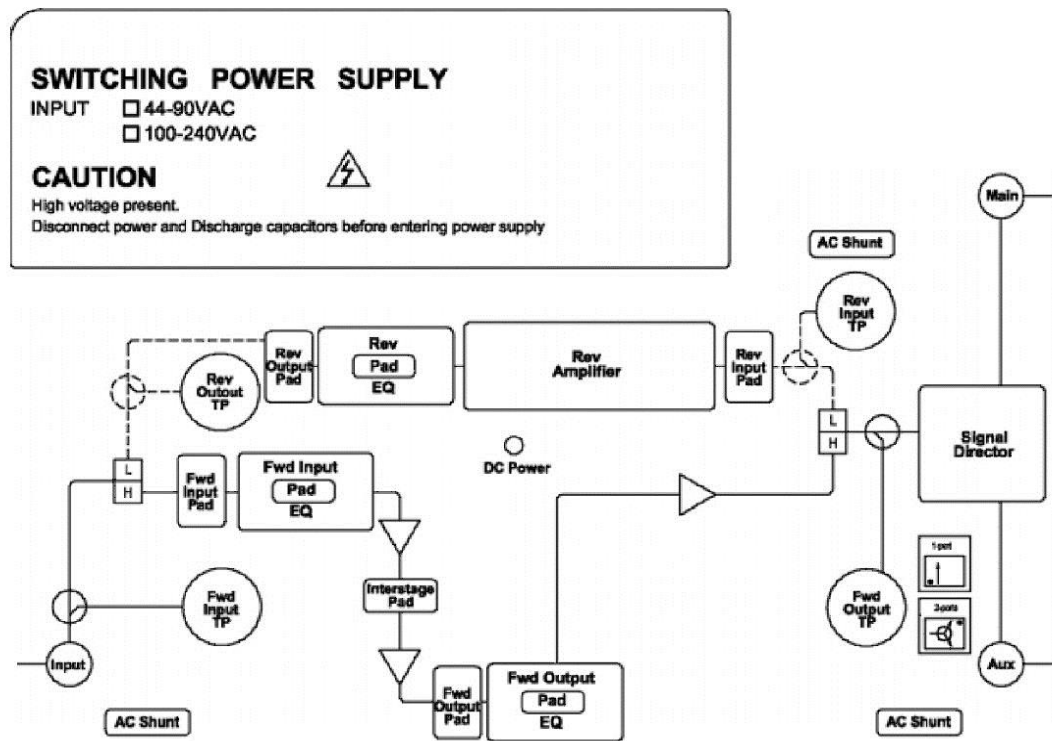

2

Installation and Configuration

Introduction

This chapter provides instructions for installing and configuring the GainStar Line Extender in your cable system.

In This Chapter

| | |
|---|----|
| ■ Before You Begin..... | 10 |
| ■ Opening the Line Extender Housing | 13 |
| ■ Attaching the Coaxial Connectors..... | 14 |
| ■ Installing the Housing..... | 17 |
| ■ Installing the Accessories..... | 19 |
| ■ System Power | 23 |
| ■ Closing the Line Extender Housing | 26 |

Before You Begin

The procedures in this chapter assume that you have completed the following:

- Prepared the installation site
- Located the coaxial cable, with or without the pin-type coaxial connectors mounted on the cable







Required Tools

Before you start, make sure that you have the following tools:

- Torque wrench with a 1/2-inch socket
- Cross screwdriver
- Heavy-duty wire cutters or snips
- Torque wrench set

Torque Specifications

The following table lists the torque specifications for the GainStar Line Extender.

| Fastener | Torque Specification | Illustration |
|-------------------------------------|-------------------------------|---|
| Housing closure bolts | 6.8 Nm to 9.0 Nm |  |
| Housing grounding screw | 0.9 Nm to 1.0 Nm |  |
| Housing plugs test point port plugs | 6.8 Nm to 9.0 Nm |  |
| RF PG11 to 5/8" adapter | 12.0 Nm to 16.0 Nm |  |
| Strand clamp mounting bracket bolts | 6.8 Nm to 9.0 Nm |  |
| RF F-Cable Connector | Per manufacturer instructions |  |
| HardLine Cable Connector | Per manufacturer instructions |  |

GainStar Line Extender Module Cover

The GainStar Line Extender module has aluminum cover attached. To perform normal field maintenance, the cover does not have to be removed.

Housing Dimensions

The diagram below shows the dimensions, in inches and millimeters, of the GainStar Line Extender housing with a standard lid. Use these measurements to calculate clearance requirements for your installation.

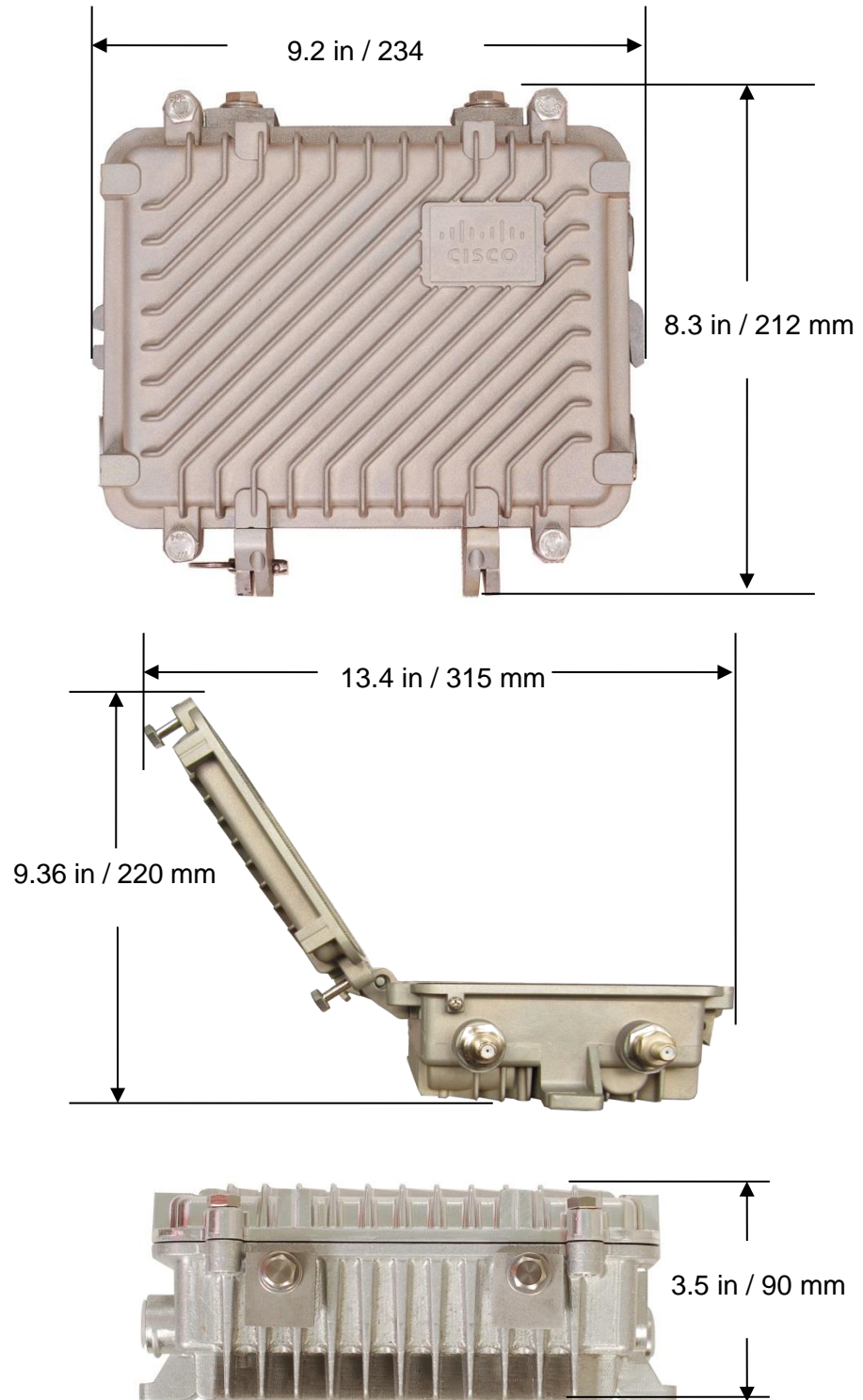

Opening the Line Extender Housing

To Open the Line Extender Housing

Complete the following steps to open the GainStar Line Extender housing.

Important: Before unscrewing the housing bolts, make sure the removable hinge locking pin is in place. The hinge locking pin prevents separation of the lid from the base.

- 1 Loosen the housing closure bolts on the housing lid.

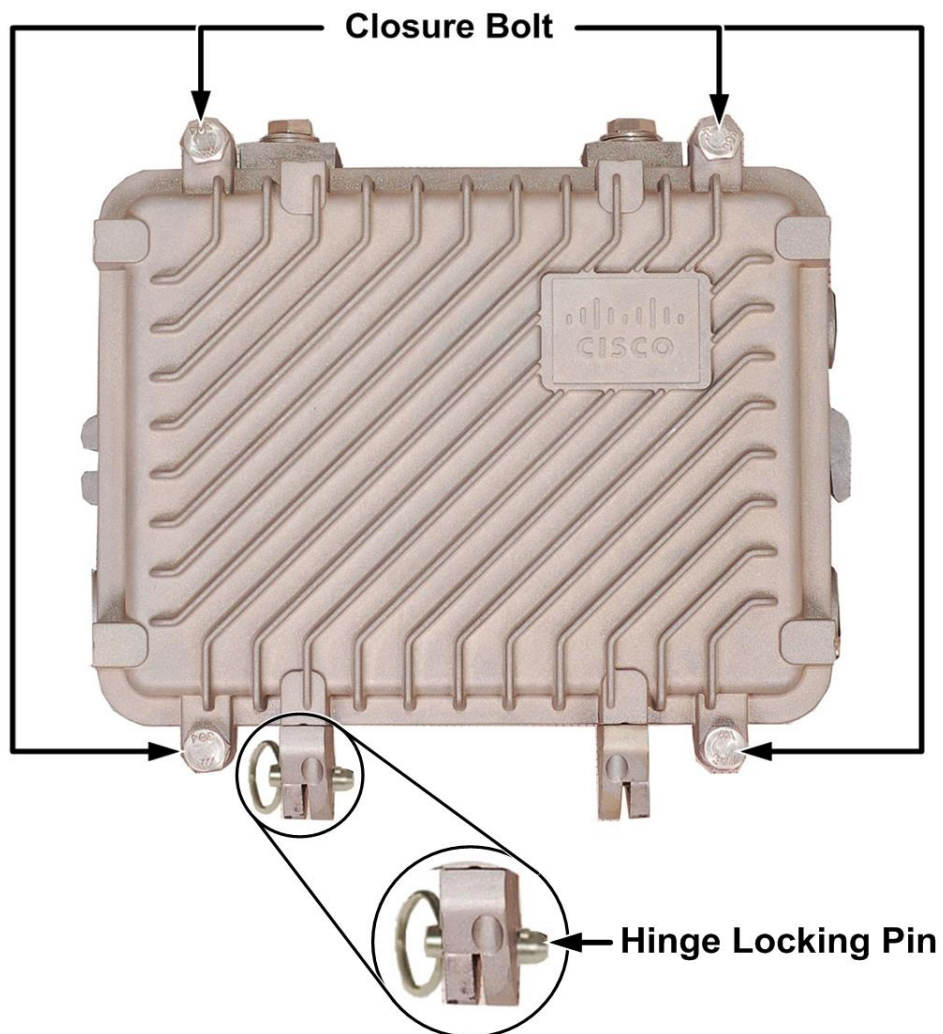

- 2 Open the housing.

Note: The closure bolts should remain attached to the housing.

Attaching the Coaxial Connectors

To Prepare the Line Extender Module for Connector Installation

Complete the following steps to trim longer pins.

- 1 Loosen the RF connector bolts.

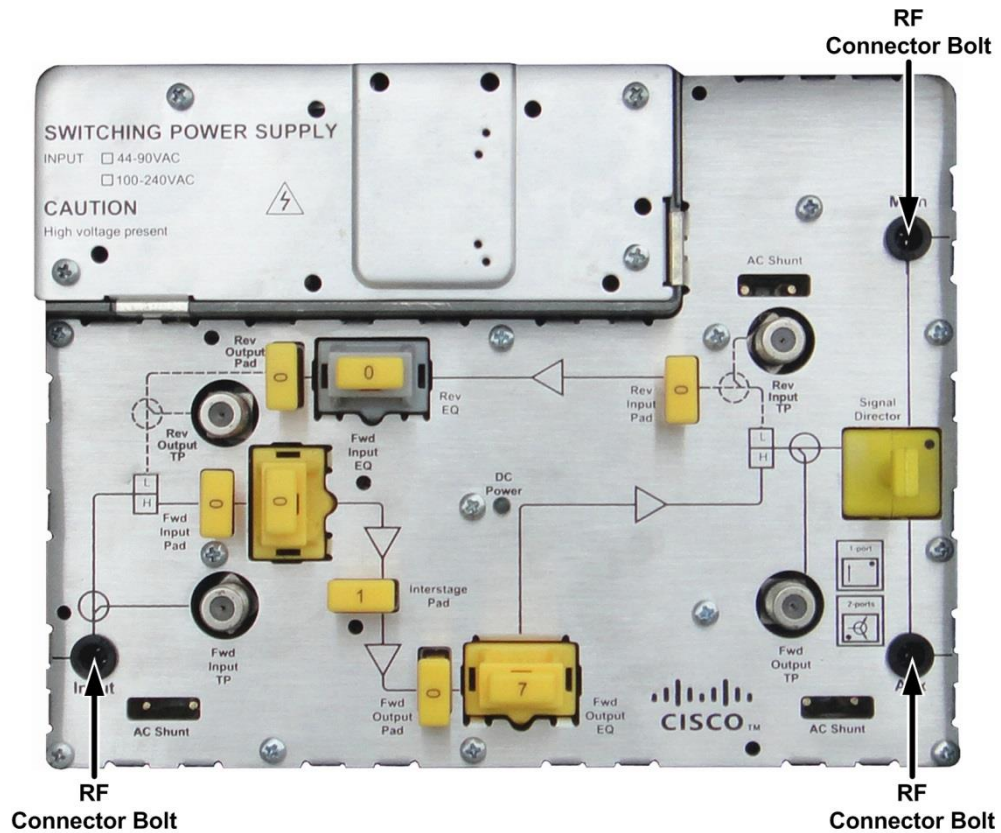

- 2 The GainStar Line Extender requires pin-type connectors for all RF connections. The 5/8" RF connector will be needed for pins extending from 33 mm to 35 mm (1.3 in. to 1.4 in). The PG11 RF connector will be needed for pins extending 29 mm to 31 mm (1.1 in. to 1.2 in). You must trim longer pins before inserting them into the housing. If the center conductor pin extends beyond the STRIP line on the housing, trim the pin flush to the STRIP line. The following diagram shows a visual guide of the center conductor trim length.

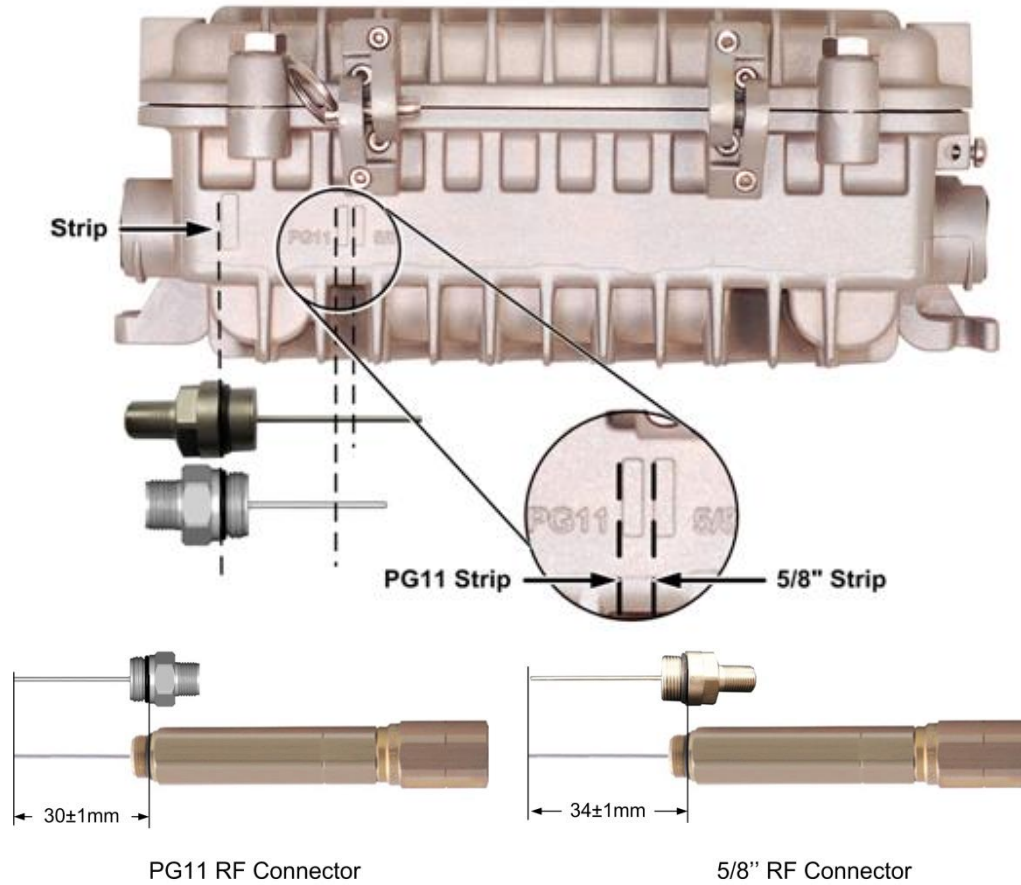

To Connect the RF Connector Pin

Complete the following steps to connect the RF connector pin to the GainStar Line Extender housing.

- 1 Begin this procedure with the GainStar Line Extender housing open.
- 2 If the center conductor pin extends beyond the STRIP line on the housing, trim the pin with heavy-duty wire cutters.
- 3 If the RF connector is PG11, go to Step 4. If the RF connector is 5/8", screw the RF cable connector adapter onto the housing before proceeding to Step 4.
- 4 Insert the appropriate RF connector into the desired RF port. Tighten the connector nut according to the manufacturer specifications.
- 5 Tighten the RF F-Cable connector bolt from 0.9 Nm to 1.0 Nm.
- 6 Repeat steps 2 through 4 for each RF port used.
- 7 Check for the presence of RF at unused port.
 - a If RF is present, insert a 75 Ohm terminator into the port and tighten per manufacturer specifications.
 - b If RF is not present, insert a housing plug into the port and tighten from 6.8 Nm to 9.0 Nm.
- 8 Proceed to Installing the Housing.

Installing the Housing

To Install the Housing on a Strand (Aerial)

Complete the following steps to install the housing on a strand (aerial). The housing does not need to be opened for strand installation.

Important: The minimum strand diameter should be 5/16 inch.



CAUTION:

Be aware of the size and weight of the housing while strand mounting. Ensure that the strand can safely support the weight of the housing.

- 1 Loosen the strand clamp bolts.
- 2 Lift the housing to the proper position on the strand.
- 3 Slip the strand clamps over the strand and finger-tighten the clamp bolts. This allows additional movement of the housing as needed.
- 4 Move the housing as needed to install the coaxial cable and connectors. See the diagram below.

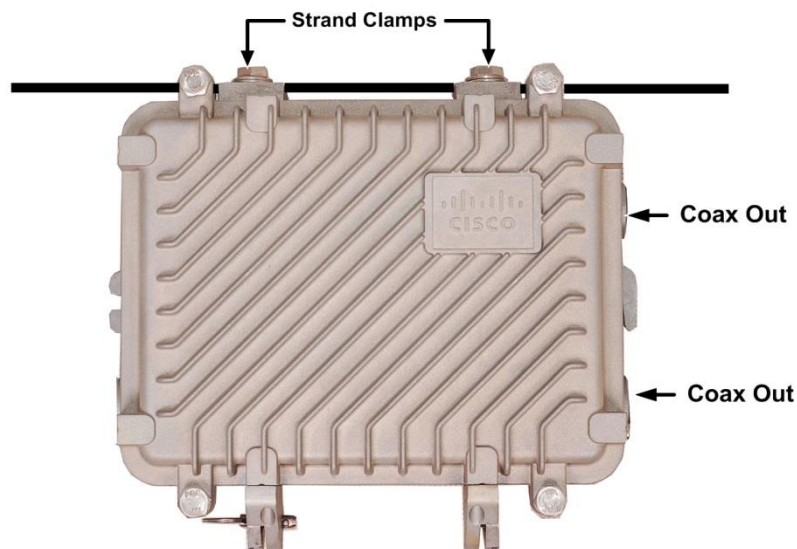

- 5 Using a 1/2-inch torque wrench, tighten the strand clamp bolts from 6.8 Nm to 9.0 Nm. Make sure there is good mechanical contact between the strand and the housing.

Note: A slight tilt of the housing face is normal. Cable tension will cause the housing to hang more closely to vertical.

- 6 Connect the coaxial cable to the pin connector according to connector manufacturer specifications.
- 7 Proceed to Installing the Accessories.

To Install the Housing in a Pedestal

Complete the following steps to install the housing on a pedestal.

- 1 Drill two 3/8" holes in the mounting plate with 127 mm or 215.9 mm distance. The thickness of the metal plate is 10 to 15 mm.
- 2 Lift the housing to the proper position on the wall or box.
- 3 Align the pedestal mounting holes on the bottom of the housing with the two holes drilled in the metal plate and insert the bolts into the two threaded mounting holes.

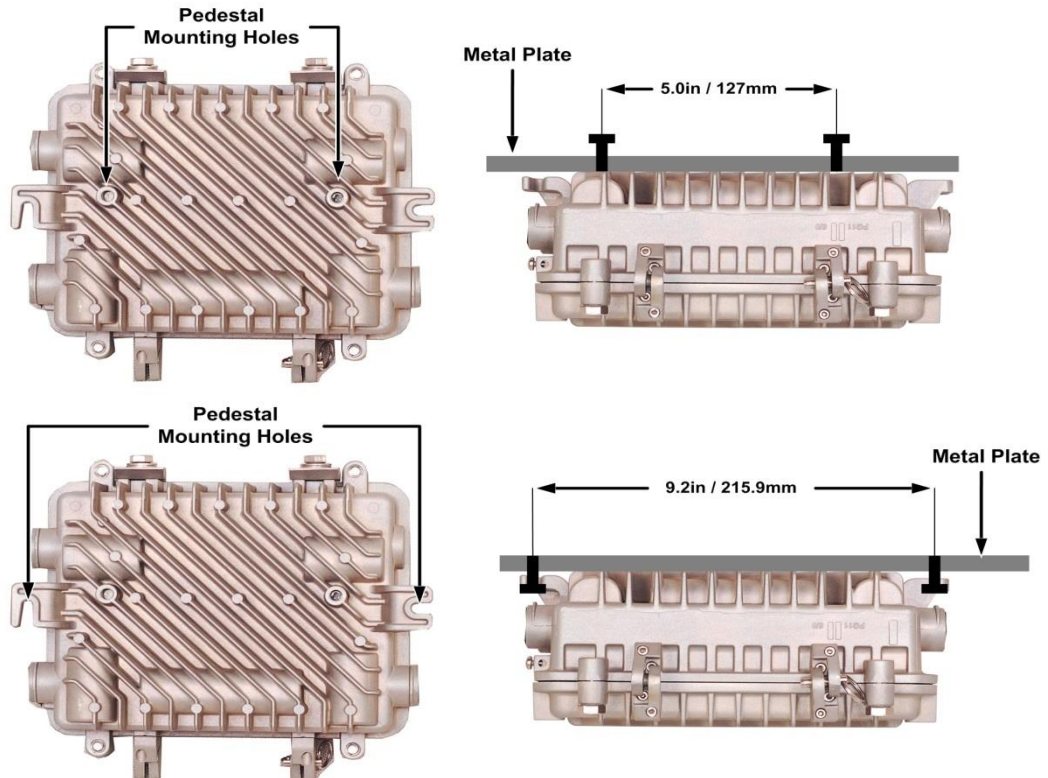

- 4 Using a 1/2-inch torque wrench, tighten the pedestal clamp bolts from 6.8 Nm to 9.0 Nm.
- 5 Connect the coaxial cable to the pin connector according to connector manufacturer specifications.
- 6 Proceed to Installing the Accessories.

Installing the Accessories

To Install the Attenuator Pads

Complete the following steps to install the attenuator pads in the GainStar Line Extender.

Note: For the best results, follow this installation procedure exactly.

- 1 Start this procedure with the housing open. Refer to *Opening the Line Extender Housing*.

Note: These accessories can be installed without removing the cover.

- 2 Install the pad(s) specified by the design print in the appropriate pad slot(s).

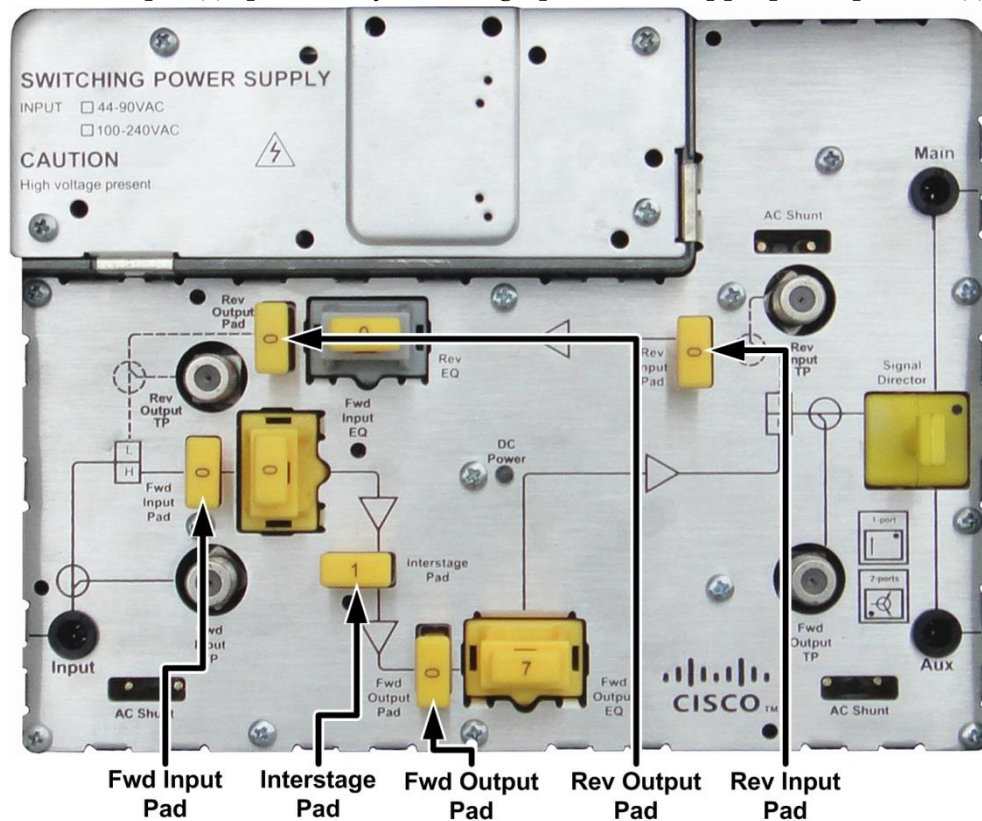

Note:

- Be sure that all the pins on the attenuator pad bottom align with the pin holes in the attenuator pad slot, allowing the attenuator pad to be installed flat against the GainStar Line Extender module.
 - The forward output pad and forward interstage pad (1 GHz: 1 dB) are installed at the factory to set the operational gain of the station. Do not change these pads in the field unless required by system design.
- 3 Install other options or accessories as desired.

To Install the Equalizers

Complete the following steps to install the equalizers in the GainStar Line Extender.

Note: For the best results, follow this installation procedure exactly.

- 1 Start this procedure with the housing open. Refer to *Opening the Line Extender Housing*.

Note: These accessories can be installed without removing the cover.

- 2 Install the forward input equalizer specified by the design print in the forward input equalizer slot. Or, install the correct inverse equalizer specified by the design print for your system in the forward input equalizer slot. Equalizer values can be set up by adjusting the pad. Detailed instructions on tilt value set up can be found on page 31. For a list of available accessory pad values and part numbers, see *Technical Information*.

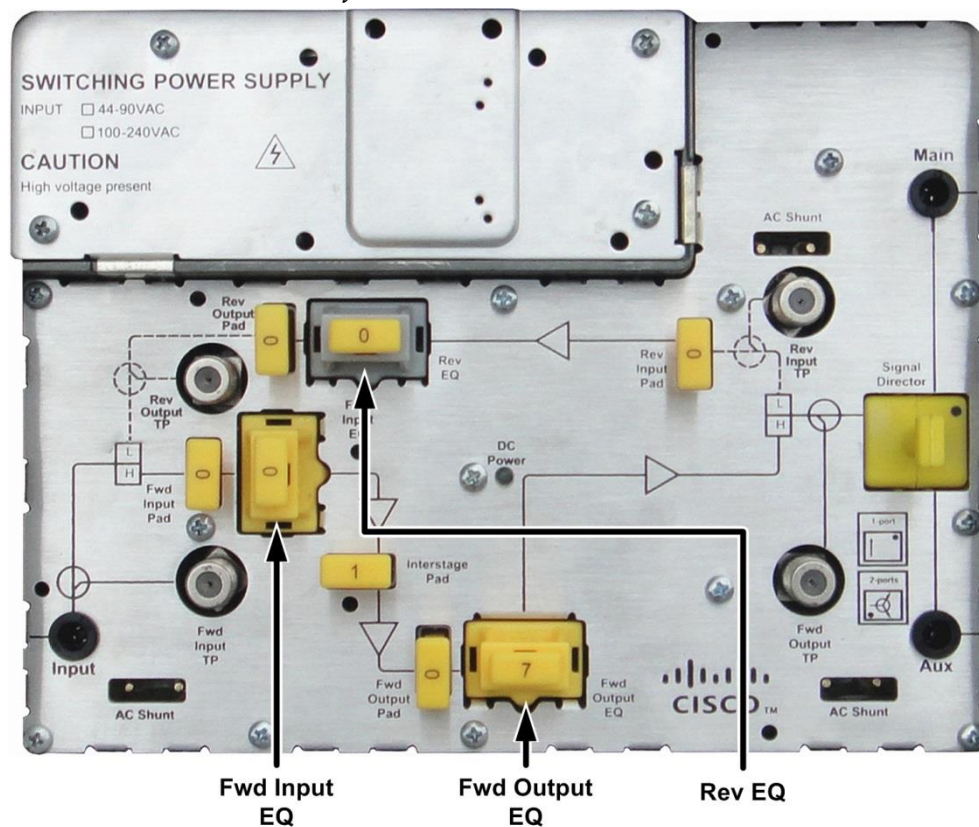

Note:

- Be sure that all the pins on the forward input equalizer or inverse equalizer bottom align with the pin holes in the equalizer slot, allowing the equalizer to be installed flat against the GainStar Line Extender module.
- The forward output equalizer and pad (1 GHz: 7 dB) are factory installed, and should not be changed in the field.
- The forward output equalizer and an on-board equalizer combine to generate the total internal tilt for the station.



- 3 Install the reverse equalizer specified by the design print in the reverse equalizer slot. The default factory reverse tilt is set at 0 dB. For the exact location of the reverse equalizer, refer to the accompanying illustration. For a list of available reverse equalizers, see *Technical Information*.
- 4 Install other options or accessories as desired.

To Set up RF Output Port

Follow these steps to test the GainStar Line Extender.

- 1 Factory default is one Main output port.
- 2 Before powering up the GainStar Line Extender, make sure all the accessories are installed and properly seated.
- 3 Make sure the unit is properly connected to the power supply. Refer to *System Power*.
- 4 For one High-level output, RF output Main is the active port. For two outputs, both the RF output Main and RF output Aux are the active ports. Make sure a Signal Director (SD) or Directional Coupler is installed in the position marked "Signal Director" on the GainStar Line Extender.

The specifications of the Signal Director and the Directional Coupler are listed in the table below.

| Item | Illustration | Description |
|--------------------------|---|---|
| Signal Director |  | Controls one or two RF outputs. The Aux port output level has the same value as the Main port output level. |
| DC8 Directional Coupler |  | Controls one or two RF outputs. In the forward path, the typical attenuations are 7.8 dB (Aux port output level) and 2.0 dB (Main port output level); in the reverse path, the typical attenuations are 8.4 dB (Aux port output level) and 1.8 dB (Main port output level). |
| DC12 Directional Coupler |  | Controls one or two RF outputs. In the forward path, the typical attenuations are 12.0 dB (Aux port output level) and 1.5 dB (Main port output level); in the reverse path, the typical attenuations are 12.8 dB (Aux port output level) and 1.0 dB (Main port output level). |

Installation and Configuration

The following diagram shows the position and the usage of the Signal Director and the Directional Coupler.

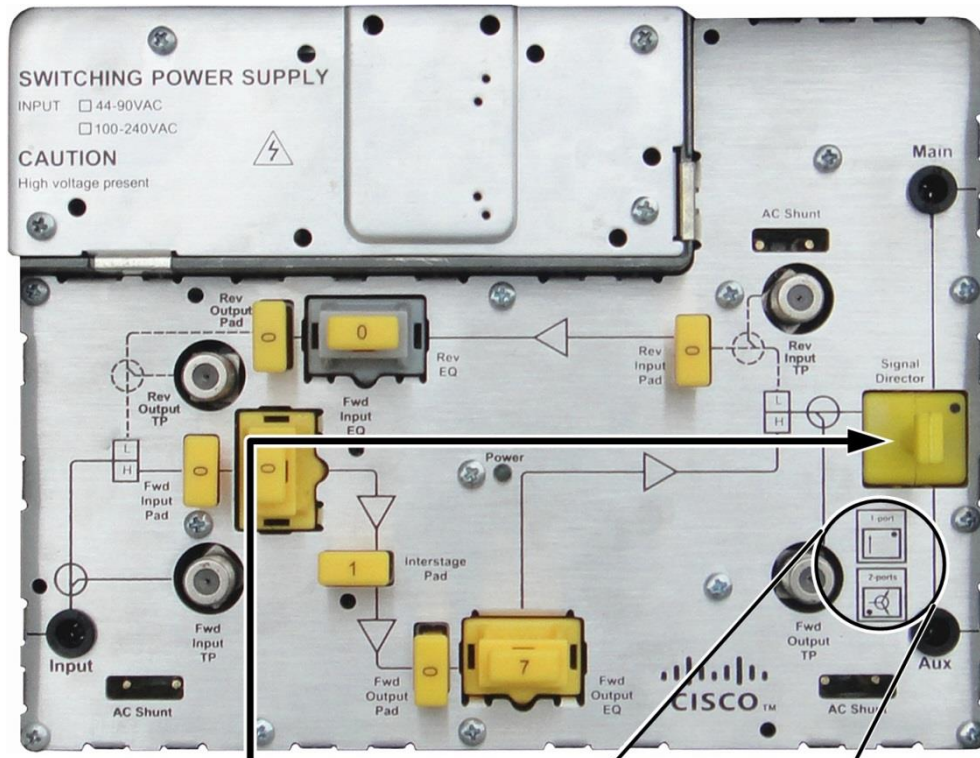

Signal Director or Directional Coupler

A black dot is printed on the Signal Director and the Directional Coupler. The position of this black dot determines the number of the active ports in the GainStar Line Extender (See the enlarged part in the diagram above). If the black dot is at the top-right corner, only the RF output Main is the active port. If the black dot is at the bottom-left corner, both the RF output Main and RF output Aux are the active ports. When installing the Signal Director and the Directional Coupler, the number of the active RF output ports is decided by the user according to the specific application requirement.

System Power

System Power (44 to 90 VAC)

The GainStar Line Extender draws AC power from the coaxial cable. This AC power comes from an external AC power supply.



CAUTION:

RF connectors and housing seizure assemblies can be damaged if AC shunt power directors are not removed from the GainStar Line Extender before installing.

Power can come from the input or output ports, and each GainStar Line Extender can pass or block AC power flow on any port without affecting the RF continuity. However, at least one port must pass AC power to bring power into the GainStar Line Extender.

To set the power direction, install AC shunt power directors for the ports through which you wish to pass AC.

Note: A red AC shunt power director is included in the unit. The red shunt is used to activate the port that supplies power. The red shunt should be removed before installing or removing the RF module from the housing.



CAUTION:

RF connectors and housing seizure assemblies can be damaged if AC shunt power directors are not removed from the GainStar Line Extender before installing or removing the GainStar Line Extender module from the housing.

Before powering up the GainStar Line Extender, make sure all accessories are installed and properly seated.

Important: The Main, Aux and RF input ports are the RF/ Power Ports.

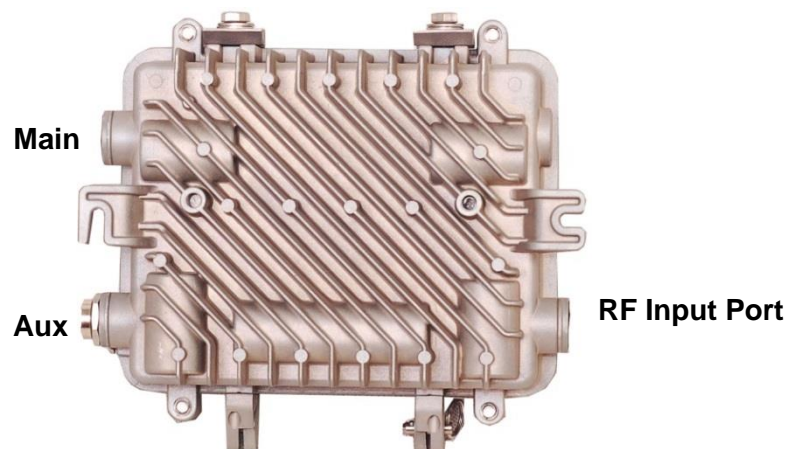

AC Shunt

Check the system maps to determine which AC Shunt should be inserted.

- 1 Open the housing. Refer to Opening the Line Extender Housing.
- 2 Plug the GainStar Line Extender power shunt (red and black) into the AC shunt locations. The red AC shunt indicates where the power goes into the GainStar Line Extender. The black AC shunt indicates where the power leaves the GainStar Line Extender. See table below as an example. The black AC shunt should be installed before the red AC shunt.
- 3 Close the housing. Refer to Closing the Line Extender Housing.

| AC Shunt | Main | Aux | RF input port |
|----------------------------|-------|-------|---------------|
| Powered from Main port | Red | Black | Black |
| Powered from Aux port | Black | Red | Black |
| Powered from RF input port | Black | Black | Red |

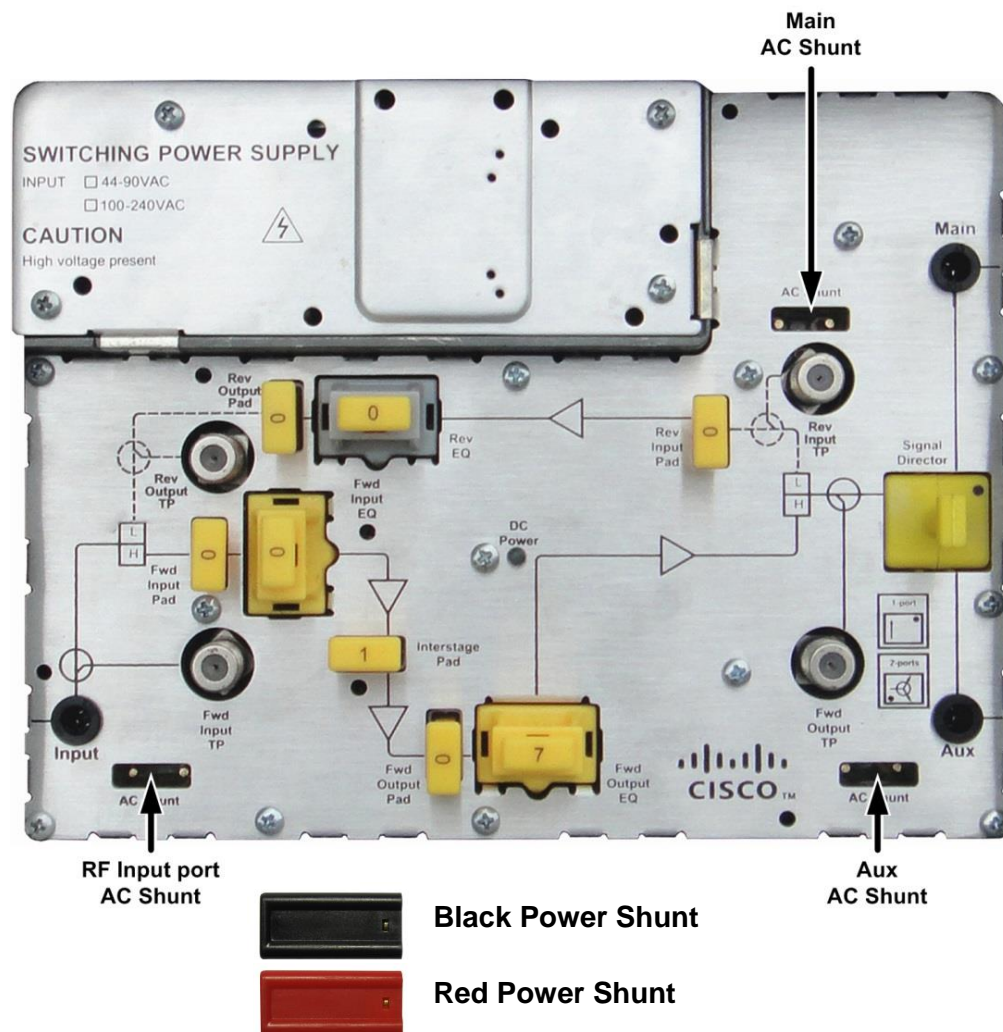

System Power (100 to 240 VAC)

The GainStar Line Extender can draw AC power from the local mains power.

The following information is applicable to the GainStar Line Extender powered by 100 to 240 VAC.

- Before powering up the GainStar Line Extender, make sure all accessories are installed and properly seated.

Note: There is no AC shunt for the GainStar Line Extender powered by 100 to 240 VAC.

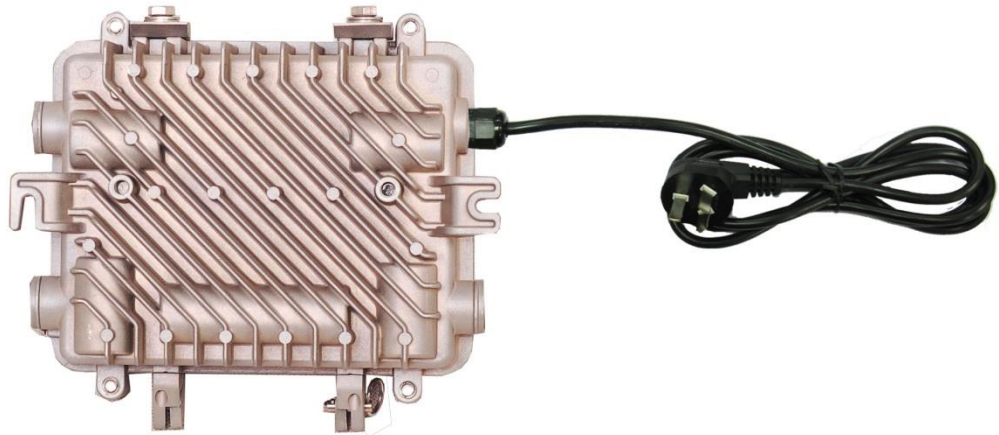

Closing the Line Extender Housing

To Close the Line Extender Housing

Complete the following steps to close the GainStar Line Extender housing.



CAUTION:

RF connectors and housing seizure assemblies can be damaged if AC shunt power directors are not removed from the GainStar Line Extender before installing.

- 1 Make sure that the housing gaskets are clean and in the correct position. Wipe off any excess dirt and debris.
- 2 Close the housing.
- 3 Lightly secure the four ½-inch closure bolts with a hex driver or ratchet.
- 4 Using a torque wrench, tighten the four closure bolts to 2.8 Nm.
Important: Tighten the closure bolts in the correct sequence as specified in *Torquing Sequence*.
- 5 Using the same pattern, tighten the housing closure bolts from 6.8 Nm to 9.0 Nm.

Torquing Sequence

The following diagram shows the proper torquing sequence for the housing closure bolts.



3

Balancing and Setup

Introduction

This chapter provides instructions for selecting and implementing the correct balancing method for the GainStar Line Extender in your cable system. Balancing sets the operating levels of the station to ensure proper performance.

Important: Use the information in this chapter to identify the equipment needed for balancing and to determine the correct forward path balancing method for your system installation.

In This Chapter

- Preparing for Forward Path Balancing 28
- Balancing the Forward Path 29
- Balancing the Reverse Path 34

Preparing for Forward Path Balancing

Before You Begin

Before you begin balancing, it is important to review and understand the following information. This information will show you which balancing process is appropriate for your GainStar Line Extender.

Before balancing, make sure that you have configured the GainStar Line Extender module according to the specifications in your design print and that the GainStar Line Extender has warmed up for approximately one hour. The table below shows the items needed for balancing.

| You need a ... | To ... |
|---|---|
| copy of the design print | determine expected input and output signal levels. |
| torque wrench with 1/2-inch socket | open and close the system amplifier housing. |
| spectrum analyzer or signal analysis meter capable of working with frequencies up to the highest design frequency | determine absolute and relative signal levels. |
| test point probe (part number 1010409) | access the test points. |
| 75 ohm coaxial cable with F-connectors on each end | connect the test point probe to the test equipment. |

Balancing the Forward Path

Introduction

Be sure to use the correct procedure for forward path balancing. Refer to *To Verify the Forward Input Level* for help in identifying the procedure that best fits your system installation and Line Extender type.

The forward section of the GainStar Line Extender performs conversion, amplification, equalization, and test point functions for the forward path signal.

To Verify the Forward Input Level

Complete the following steps to test the input signal level.

Important: You cannot balance the GainStar Line Extender without the proper input signals.

- 1 Connect the test equipment to the forward input test point shown in the illustration below.

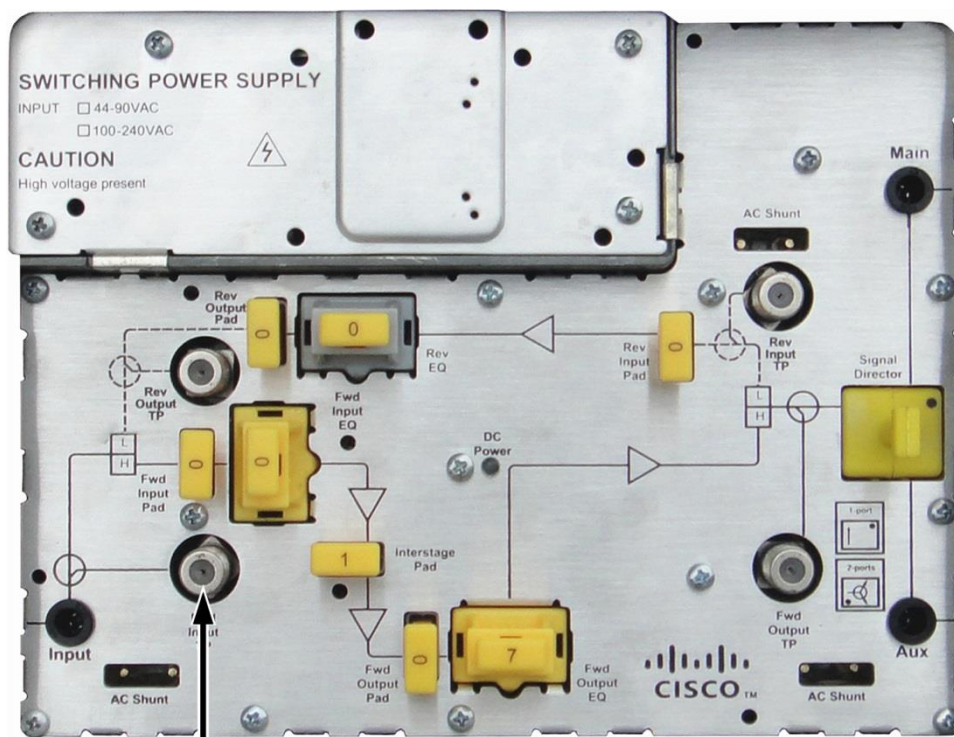

**Fwd Input
Test Point**

- 2 Measure the signal level at the following frequencies:
 - The lowest frequency specified in the system design
 - The highest frequency specified in the system design

Balancing and Setup

The RF input level recommended range is 8 dBmV to 12 dBmV. If the input level is higher than 12 dBmV, The CSO, CTB will deteriorate. You can replace the forward input pad with a higher value pad.

If the input level is less than 8 dBmV, The CNR will deteriorate. You can replace the forward input pad with a higher value pad.

- 3 Measure the forward input test point level, and compare this level with the design level. The test point attenuates input signals by 20 dB.
- 4 Are measured levels within the design limits?
 - a If yes, proceed to step 5.
 - b If no, or if no signals are present, find the problem before proceeding. You cannot balance the GainStar Line Extender without the proper input signals.
- 5 Remove the test probe from the forward input test point, leaving other equipment connectors in place.

To Determine the Output Tilt

Complete the following steps to determine the output tilt of the GainStar Line Extender.

- 1 Connect the test point probe to the forward output test point.

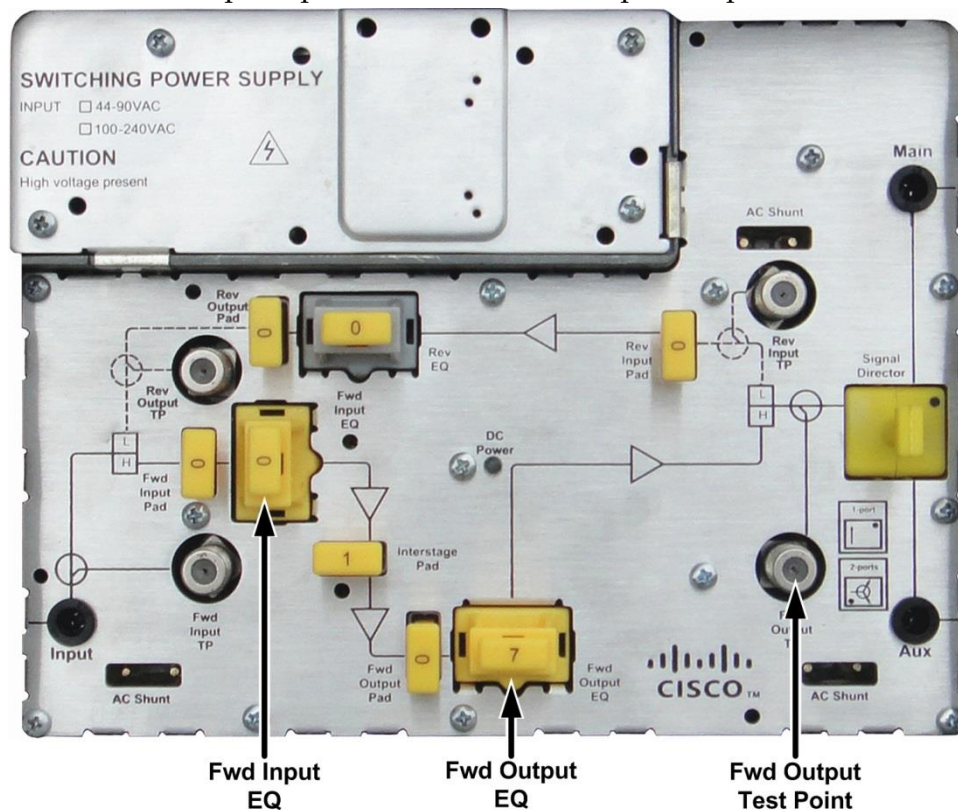

- 2 Consult the design print to find the proper output tilt.
- 3 Measure the output signal levels at the frequencies you used in *To Verify the Forward Input Level*.

- 4 To determine the actual output tilt, calculate the difference (in dB) between the levels of the lowest and highest specified frequencies.
- 5 Proceed to the next section, *To Set Up the Output Tilt*.

To Set Up the Output Tilt

1 GHz Equalizers

The forward output tilt can be adjusted using the Forward Equalizer (EQ). Each EQ has a range of values. The EQ value is set by installing the appropriate attenuator pad. There are three types of forward EQs for the 1 GHz Platform: 0 dB to 4 dB, P/N 4034453; 5 dB to 9 dB, P/N 4034454; and 10 dB to 14 dB, P/N 4034455. See the table below for the full range of configurations for the 1GHz EQs.



| Forward Equalization | Forward Equalizer | | Pad for Forward Equalizer | |
|----------------------|---|---------|-------------------------------|---------|
| | Description | PN | Description | PN |
| 0 dB | GS Fwd Cable EQ, 0 to 4 dB 1 GHz Platform | 4034453 | 0 dB 1 GHz Plug-In Attenuator | 4036021 |
| 1 dB | | | 1 dB 1 GHz Plug-In Attenuator | 4036022 |
| 2 dB | | | 2 dB 1 GHz Plug-In Attenuator | 4036023 |
| 3 dB | | | 3 dB 1 GHz Plug-In Attenuator | 4036024 |
| 4 dB | | | 4 dB 1 GHz Plug-In Attenuator | 4036025 |
| 5 dB | GS Fwd Cable EQ, 5 to 9 dB 1 GHz Platform | 4034454 | 5 dB 1 GHz Plug-In Attenuator | 4036026 |
| 6 dB | | | 6 dB 1 GHz Plug-In Attenuator | 4036027 |
| 7 dB | | | 7 dB 1 GHz Plug-In Attenuator | 4036028 |
| 8 dB | | | 8 dB 1 GHz Plug-In Attenuator | 4036029 |
| 9 dB | | | 9 dB 1 GHz Plug-In Attenuator | 4036030 |

Balancing and Setup

| | | | | |
|-------|---|---------|--------------------------------|---------|
| 10 dB | GS Fwd Cable EQ, 10 to 14 dB 1 GHz Platform | 4034455 | 10 dB 1 GHz Plug-In Attenuator | 4036031 |
| 11 dB | | | 11 dB 1 GHz Plug-In Attenuator | 4036032 |
| 12 dB | | | 12 dB 1 GHz Plug-In Attenuator | 4036033 |
| 13 dB | | | 13 dB 1 GHz Plug-In Attenuator | 4036034 |
| 14 dB | | | 14 dB 1 GHz Plug-In Attenuator | 4036035 |

- Increasing the equalizer value reduces the level at lower frequencies, relative to the level at 1 GHz.
- Decreasing the equalizer value increases the level at lower frequencies, relative to the level at 1 GHz.

Complete the following steps to select the proper forward input Equalizer value.

- 1 Compare the calculated input tilt in step 4 of *To Determine the Output Tilt* with the design tilt (on the design print).
- 2 Is the output tilt within ± 0.5 dB of the design tilt?
 - If the output tilt is within ± 0.5 dB of the design tilt, proceed to the next section, *To Set Up the Forward Output Level*.
 - If the output tilt is more than the design tilt, replace the forward input EQ with a lower value EQ.
 - If the output tilt is less than the design tilt, replace the forward input EQ with a higher value EQ.
- 3 Measure the output tilt again, and then return to step 1.

Note:

- The forward output equalizer is installed at the factory, and should not be changed in the field.
- The plug-in output equalizer and an on-board equalizer combine to generate the total internal tilt for the station.

To Set Up the Forward Output Level

After setting the tilt, complete the following steps to select the proper pad values for the GainStar Line Extender. The output level of the GainStar Line Extender is set by selecting the proper pad value.

- 1 Connect the test probe to the forward output test point.
- 2 Measure the output level at the highest design frequency, and compare it with the design level (on the design print).
 - 1000 MHz for 1000 MHz version

If the Signal Director is installed, add 20 dB (single output) or 16.5 dB (dual outputs) to the measured levels to get the true output levels.

If the DC8 Directional Coupler is installed, add 20 dB (single output) or 18.0 dB (Main port output) /12.2 dB (Aux port output) to the measured levels to get the true output levels.

If the DC12 Directional Coupler is installed, add 20 dB (single output) or 18.5 dB (Main port output) /8 dB (Aux port output) to the measured levels to get the true output levels.

- 3 Are the output levels within +/-0.5 dB of the design level?
 - If yes, proceed to step 5.
 - If the output level is more than the design output level, replace the forward input pad with a higher value pad.
 - If the output level is less than the design output level, replace the forward input pad with a lower value pad, and proceed to step 5.
- 4 Repeat steps 2 and 3 until the output level is correct.
- 5 Proceed to To Set Up the Reverse Input Level.

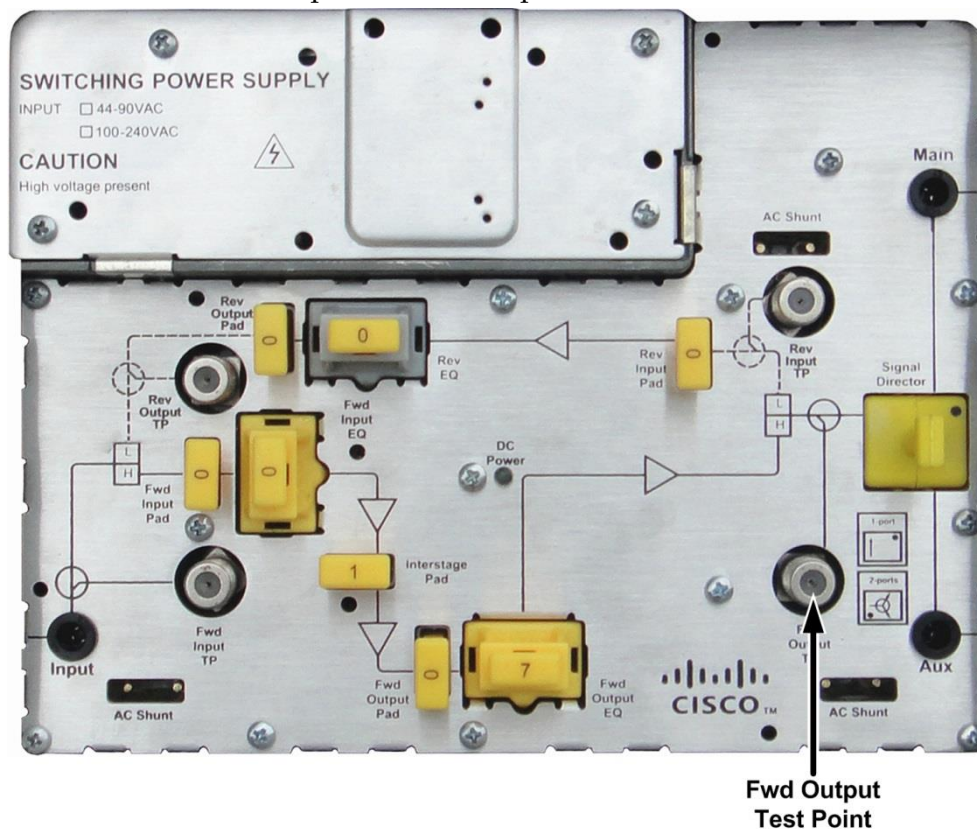

CAUTION:

The pad should be configured carefully to control the forward output level, otherwise, the output module damage may occur, which will result in the GainStar Line Extender distortion.

Balancing the Reverse Path

Introduction

This section describes reverse RF Line Extender cascade balancing. Balancing refers to the process of individually aligning reverse GainStar Line Extender station gain and tilt characteristics to achieve reverse GainStar Line Extender cascades that have optimum, repeatable transmission characteristics.

There are a variety of test equipment combinations that enable proper balancing of the reverse path. Regardless of the type of the equipment used, the balancing process is fundamentally the same.

To Set Up the Reverse Input Level

Complete the following steps to test the reverse input level.

Important: You cannot balance the GainStar Line Extender without the proper reverse input signals.

- 1 Connect the test equipment to the reverse input test point shown in the illustration below.

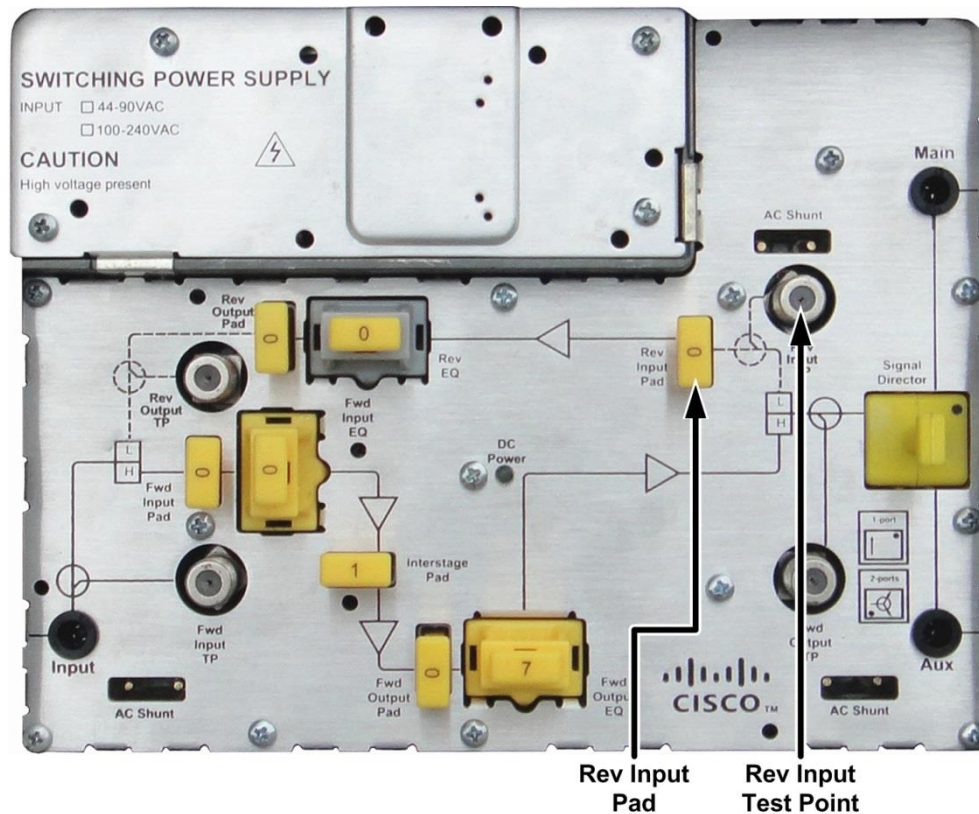

- 2 Measure the signal level. The recommended range is 5 dBmV/ch to 20 dBmV/ch.

- 3 Measure the input level, and compare it with the design level.
 If the Signal Director is installed, add 20 dB (single input) or 23.5 dB (dual inputs) to the measured levels to get the true input levels.
 If the DC8 Directional Coupler is installed, add 20 dB (single input) or 21.8 dB (Main port input) / 28.4 dB (Aux port input) to the measured levels to get the true input levels.
 If the DC12 Directional Coupler is installed, add 20 dB (single input) or 21.0 dB (Main port input) / 32.8 dB (Aux port input) to the measured levels to get the true input levels.
- 4 Are the input levels within the design limits?
 - If yes, proceed to step 5.
 - If no, or if no signals are present, find the problem before proceeding. You cannot balance the GainStar Line Extender without proper input signals.
- 5 Remove the test probe from the forward input test point, leaving other equipment connectors in place.

To Set Up the Reverse Output Level

Complete the following steps to test the reverse output level.

- 1 Connect the test equipment to the reverse output test point shown in the illustration below.

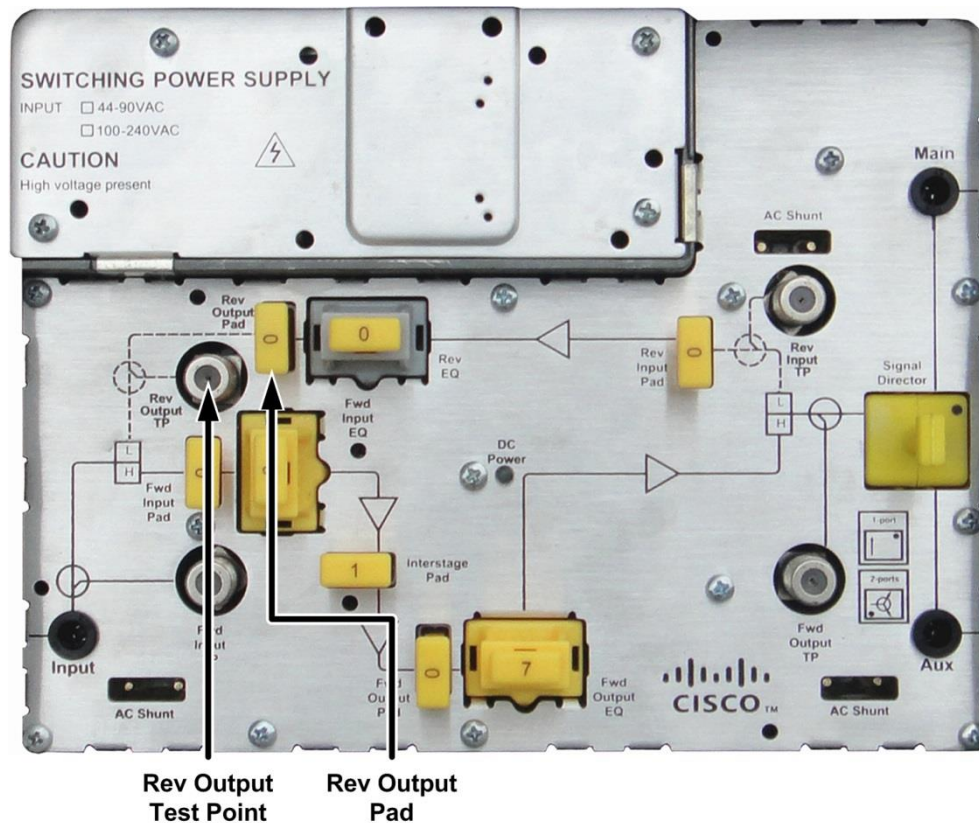

Balancing and Setup

- 2 Measure the output level, and compare this level with the design level. The test point attenuates output signals by 20 dB.
- 3 Is the measured output level within ± 0.5 dB of the design level?
 - If yes, proceed to step 5.
 - If the output level is more than the design output level, replace the reverse output pad with a higher value pad.
 - If the output level is less than the design level, replace the reverse output pad with a lower value pad.
- 4 Repeat steps 2 and 3 until the output level is correct.
- 5 Remove the test probe from the reverse output test point, leaving other equipment connectors intact.

To Set Up the Equalizer Values for Reverse Path

85 MHz Platform

The reverse output tilt can be adjusted using the Reverse Equalizer (EQ). Each EQ has a range of values. The EQ value is set by installing the corresponding attenuator pad. There are two types of reverse EQs for the 85 MHz Platform: 0 dB to 5 dB, P/N GS-REQ-85-00-05; 6 dB to 10 dB, P/N GS-REQ-85-06-10. See the table below for the full range of configurations for the 85 MHz Platform EQs.

| Reverse Equalization | Reverse Equalizer | | Pad for Reverse Equalizer | |
|----------------------|---|-----------------------------|--------------------------------|---------|
| | Description | PN | Description | PN |
| 0 dB * | GS Rev Cable EQ, 0 to 5 dB 85 MHz Platform | GS-REQ-85-00-05, 0 to 5 dB | 0 dB 1 GHz Plug-In Attenuator | 4036021 |
| 1 dB | | | 1 dB 1 GHz Plug-In Attenuator | 4036022 |
| 2 dB | | | 2 dB 1 GHz Plug-In Attenuator | 4036023 |
| 3 dB | | | 3 dB 1 GHz Plug-In Attenuator | 4036024 |
| 4 dB | | | 4 dB 1 GHz Plug-In Attenuator | 4036025 |
| 5 dB | | | 5 dB 1 GHz Plug-In Attenuator | 4036026 |
| 6 dB | GS Rev Cable EQ, 6 to 10 dB 85 MHz Platform | GS-REQ-85-06-10, 6 to 10 dB | 6 dB 1 GHz Plug-In Attenuator | 4036027 |
| 7 dB | | | 7 dB 1 GHz Plug-In Attenuator | 4036028 |
| 8 dB | | | 8 dB 1 GHz Plug-In Attenuator | 4036029 |
| 9 dB | | | 9 dB 1 GHz Plug-In Attenuator | 4036030 |
| 10 dB | | | 10 dB 1 GHz Plug-In Attenuator | 4036031 |

* The section in gray indicates factory default value.



Complete the following steps to select the proper reverse equalizer value.

- 1 Connect the test probe to the reverse output test point.

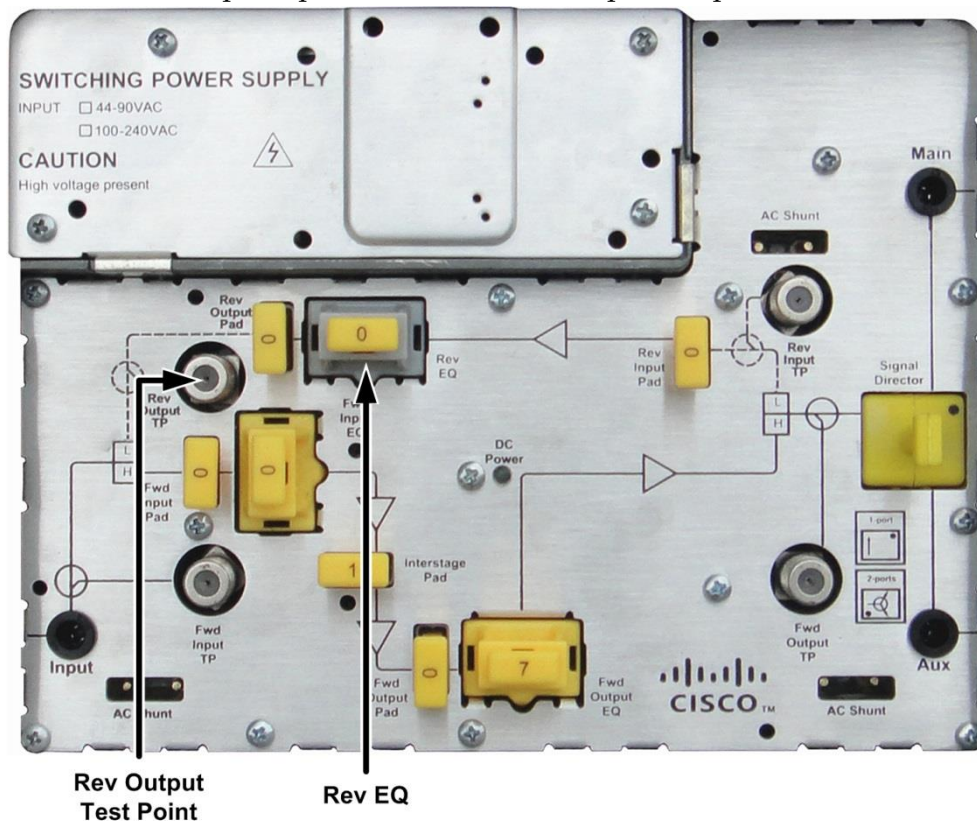

- 2 Compare the calculated tilt with the design tilt (on the design print).
- 3 Is the reverse output tilt within ± 0.5 dB of the design tilt?
 - If yes, proceed to the next section.
 - If the output tilt is more than the design tilt, replace the reverse EQ with a

Balancing and Setup

lower value EQ.

- If the output tilt is less than the design tilt, replace the reverse EQ with a higher value EQ.
- 4 Measure the output tilt again.

Note: The reverse equalizer is installed at the factory with 0 dB pad.

4

Troubleshooting

Introduction

This chapter describes the steps you may take to troubleshoot the GainStar Line Extender.

In This Chapter

| | |
|--|----|
| ■ Equipment..... | 40 |
| ■ No Forward RF Signal..... | 41 |
| ■ Low or Degraded Forward RF Signal..... | 42 |
| ■ No Reverse RF Signal..... | 43 |
| ■ Low or Degraded Reverse RF Signal..... | 44 |
| ■ No Power Supply..... | 46 |
| ■ Boot Color Table..... | 47 |

Equipment

The following equipment may be necessary to perform some troubleshooting procedures.

- Compressed air (also called “canned air”)
- Spectrum analyzer or field strength meter to measure RF levels
- Test point probe, part number 1010409, to access test points

No Forward RF Signal

The forward RF signal can be measured at the Line Extender module forward input and at the forward output test point.

No Forward RF Signal Troubleshooting Table

Before you begin troubleshooting for no forward RF signal, verify that the GainStar Line Extender is receiving the proper forward RF input signal from the upstream amplifier.

| Possible Cause | Solution |
|---|---|
| No forward RF signal at the forward input test point. | <p>Verify the connection of the RF Cable Connector.</p> <p>Verify that the line extender is receiving the proper forward RF input signal from the upstream amplifier.</p> <p>Important: You cannot balance the line extender without the proper forward RF input signal.</p> |
| There is forward RF signal at the forward input test point, but no signal at the forward output test point. | <p>Verify that all the proper accessories, pads, EQs, and signal directors (if applicable) are firmly installed in the correct locations.</p> <p>Verify that the accessories are firmly installed in the correct locations.</p> <p>Replace the RF mainboard.</p> |

Low or Degraded Forward RF Signal

The forward RF signal can be measured at the GainStar Line Extender module forward input and forward output main test point.

Low or Degraded Forward RF Signal Troubleshooting Table

Before you begin troubleshooting for a low or degraded forward RF signal, verify that the GainStar Line Extender is receiving the proper forward RF input signal from the upstream amplifier.

Important: You cannot balance the GainStar Line Extender without the proper forward RF input signal.

Make sure you have configured the GainStar Line Extender module according to the specifications in the design print, and the GainStar Line Extender has warmed up for approximately one hour.

Make sure you are using the proper tilt reference when setting levels. An 1 GHz design balanced at 550 MHz requires a corrected tilt reference to compensate for the difference in carrier levels between 550 MHz and 1 GHz. The tilt reference at 550 MHz is lower than the tilt reference at 1 GHz. Refer to the tilt charts in *Technical Information* for more information.

| Possible Cause | Solution |
|---|--|
| The forward RF signal is weak or degraded at the forward input test point. | <p>Verify that the line extender is receiving the proper forward RF input signal from the upstream amplifier.</p> <p>Important: You cannot balance the line extender without the proper forward RF input signal.</p> |
| The forward RF signal is normal at the forward input test point, but it is weak or degraded at the forward output test point. | <p>Verify that all the proper accessories, pads, EQs, and signal directors (if applicable) are firmly installed in the correct locations.</p> <p>Verify that the factory installed accessories are firmly installed in the correct locations.</p> <p>Replace the RF mainboard.</p> |

No Reverse RF Signal

The reverse RF signal can be measured at the GainStar Line Extender module reverse input and reverse output test point.

No Reverse RF Signal Troubleshooting Table

Before you begin troubleshooting for no reverse RF signal, verify that the GainStar Line Extender is receiving the proper reverse RF input signals from the downstream amplifiers at the GainStar Line Extender reverse input and reverse output test points.

Important: You cannot balance the GainStar Line Extender without the proper reverse RF input signals.

| Possible Cause | Solution |
|--|--|
| No reverse RF signal at the reverse input test point. | <p>Verify the connection of RF Cable Connector.</p> <p>Verify that the line extender is receiving the proper reverse RF input signals from the downstream amplifiers.</p> <p>Important: You cannot balance the line extender without the proper reverse RF input signals.</p> |
| There is proper reverse RF signal at the reverse input test point, but no signal at the reverse output test point. | <p>Verify that the line extender module is receiving the proper forward RF signal. Refer to <i>No Forward RF Signal</i>.</p> <p>Verify that all the proper accessories, pads, EQs, and signal director are firmly installed in the correct locations of GainStar Line Extender.</p> <p>Verify that the factory installed accessories are firmly installed in the correct locations.</p> <p>Verify that the 3-stage switch (if applicable) or its jumpers are properly and firmly installed.</p> <p>Replace the RF mainboard of GainStar Line Extender.</p> |

Low or Degraded Reverse RF Signal

The reverse RF signal can be measured at the GainStar Line Extender module reverse input and reverse output test points.

Low or Degraded Reverse RF Signal Troubleshooting Table

Before you begin troubleshooting for a low or degraded reverse RF signal, verify that the GainStar Line Extender is receiving the proper reverse RF input signals from the downstream amplifiers at the GainStar Line Extender module reverse input main test point.

Important: You cannot balance the GainStar Line Extender without the proper reverse RF input signals.

Make sure you have configured the GainStar Line Extender module according to the specifications in the design print, and that the GainStar Line Extender has warmed up for approximately one hour.

Make sure you are using the proper total tilt reference when setting receive levels.

Refer to the reverse equalizer charts in *Technical Information* for more information.

| Possible Cause | Solution |
|--|--|
| <p>Low or degraded reverse RF signal at the reverse input test point(s).</p> | <p>Verify that the line extender is receiving the proper reverse RF input signals from the downstream amplifiers.</p> <p>Important: You cannot balance the line extender without the proper reverse RF input signals.</p> |
| <p>There is proper reverse RF signal at the reverse input test point, but low or degraded signal at the reverse output test point.</p> | <p>Measure the main reverse input test point and the reverse output test point. Subtract the reverse amplifier gain and add the pad values and EQ insertion loss to verify proper reverse amplifier gain.</p> <p>Verify that all the proper accessories, pads, EQs, and signal directors (if applicable) are firmly installed in the correct locations of the GainStar Line Extender.</p> <p>Verify that the factory installed accessories are firmly installed in the correct locations.</p> <p>Verify that any unused RF ports are properly terminated.</p> <p>Use a spectrum analyzer to look at the reverse RF input signal spectral quality at each reverse input test point and compare it with the reverse RF output signal spectral quality.</p> |
| <p>Reverse RF signal still low or degraded.</p> | <p>If degradation is generated in the reverse amplifier, replace the RF mainboard of the GainStar Line Extender.</p> <p>If degradation is generated by the downstream amplifier reverse RF signal, troubleshoot the RF amplifier feeding this station.</p> <p>Replace the RF mainboard of the GainStar Line Extender.</p> |

No Power Supply

No Power Supply

Before you begin troubleshooting for the power supply, verify that the power supply is receiving power.

Important: You cannot balance the GainStar Line Extender without the proper power supply.

| Possible Cause | Solution |
|------------------|---|
| No Power supply. | Verify that the power supply is receiving power. Important: You cannot balance the GainStar Line Extender without the proper power supply. Replace the GainStar Line Extender Housing lid. |

Boot Color Table

This table shows the factory standard for boot color that applies to SC connectors.

| Connector Description | Boot Color |
|---------------------------------|------------|
| Ultra Polished, UPC | Blue |
| Angled polished, APC (standard) | Green |

Note: For instructions on maintaining fiber optic connectors, see *Cleaning Optical Connectors*.

5

Customer Support Information

If You Have Questions

If you have technical questions, call Cisco Services for assistance. Follow the menu options to speak with a service engineer.

Access your company's extranet site to view or order additional technical publications. For accessing instructions, contact the representative who handles your account. Check your extranet site often as the information is updated frequently.

A

Technical Information

Introduction

This appendix contains forward and reverse equalizer typical insertion loss at various frequencies.

In This Appendix

| | |
|--|----|
| ■ Forward Cable Equalizer | 52 |
| ■ Forward Inverse Cable Equalizer | 53 |
| ■ Reverse Cable Equalizer | 54 |
| ■ GainStar Line Extender Accessories Part Numbers..... | 56 |

Forward Cable Equalizer

1 GHz Forward Cable Equalizer Loss Table

| EQ Value (dB) | Part Number | Typical Insertion Loss (dB) at Various Frequencies (MHz) | | | | | | | | |
|---------------|-------------|--|------|------|-----|-----|-----|-----|-----|------|
| | | 54 | 77 | 86 | 550 | 600 | 650 | 750 | 870 | 1000 |
| 0 | 4034453 | 0.6 | 0.6 | 0.6 | 0.2 | 0.2 | 0.2 | 0.2 | 0.2 | 0.3 |
| 1 | | 1.6 | 1.6 | 1.6 | 0.7 | 0.7 | 0.6 | 0.5 | 0.5 | 0.6 |
| 2 | | 2.6 | 2.3 | 2.2 | 1.2 | 1.1 | 1.0 | 0.9 | 0.9 | 0.8 |
| 3 | | 3.6 | 3.5 | 3.5 | 1.6 | 1.5 | 1.4 | 1.2 | 1.0 | 0.9 |
| 4 | | 4.6 | 4.5 | 4.4 | 2.0 | 1.9 | 1.8 | 1.5 | 1.2 | 0.9 |
| 5 | 4034454 | 5.9 | 5.8 | 5.7 | 2.7 | 2.6 | 2.3 | 2.0 | 1.5 | 0.9 |
| 6 | | 6.8 | 6.7 | 6.7 | 3.1 | 2.9 | 2.6 | 2.2 | 1.6 | 0.9 |
| 7 | | 7.8 | 7.7 | 7.6 | 3.6 | 3.3 | 2.9 | 2.4 | 1.7 | 0.9 |
| 8 | | 8.8 | 8.7 | 8.6 | 4.0 | 3.7 | 3.2 | 2.6 | 1.8 | 0.9 |
| 9 | | 9.8 | 9.6 | 9.5 | 4.3 | 4.0 | 3.5 | 2.8 | 1.9 | 0.9 |
| 10 | 4034455 | 10.7 | 10.5 | 10.4 | 4.7 | 4.3 | 3.9 | 3.1 | 2.1 | 1.0 |
| 11 | | 11.7 | 11.5 | 11.4 | 5.0 | 4.6 | 4.1 | 3.2 | 2.1 | 1.0 |
| 12 | | 12.7 | 12.4 | 12.3 | 5.3 | 4.8 | 4.3 | 3.4 | 2.2 | 1.0 |
| 13 | | 13.6 | 13.3 | 13.2 | 5.5 | 5.0 | 4.5 | 3.5 | 2.2 | 1.0 |
| 14 | | 14.6 | 14.2 | 14.0 | 5.8 | 5.2 | 4.6 | 3.5 | 2.2 | 1.0 |

Forward Inverse Cable Equalizer

105 MHz Inverse Equalizer Loss Table

| EQ Value (dB) | Part Number | Typical Insertion Loss (dB) at Various Frequencies (MHz) | | | | | | |
|---------------|---------------------------|--|------|------|-------|-------|-------|-------|
| | | 105 | 550 | 600 | 650 | 750 | 862 | 1000 |
| 0 | GS-FIEQ -105-00-0 4 | 0.01 | 0.21 | 0.24 | 0.25 | 0.30 | 0.34 | 0.42 |
| 1 | | 0.39 | 0.96 | 1.02 | 1.05 | 1.14 | 1.24 | 1.44 |
| 2 | | 0.53 | 1.65 | 1.73 | 1.79 | 1.93 | 2.12 | 2.45 |
| 3 | | 0.56 | 2.37 | 2.47 | 2.53 | 2.73 | 2.98 | 3.40 |
| 4 | | 0.55 | 3.06 | 3.19 | 3.28 | 3.52 | 3.81 | 4.29 |
| 5 | GS-FIEQ -105-05-0 9 | 0.31 | 3.56 | 3.74 | 3.92 | 4.29 | 4.80 | 5.65 |
| 6 | | 0.29 | 3.96 | 4.17 | 4.39 | 4.84 | 5.44 | 6.43 |
| 7 | | 0.26 | 4.79 | 5.07 | 5.36 | 5.93 | 6.67 | 7.78 |
| 8 | | 0.24 | 5.03 | 5.38 | 5.72 | 6.41 | 7.26 | 8.57 |
| 9 | | 0.22 | 5.49 | 5.91 | 6.31 | 7.13 | 8.12 | 9.58 |
| 10 | GS-FIEQ -105-10-1 4 | 0.56 | 7.28 | 7.69 | 8.08 | 8.87 | 9.88 | 11.50 |
| 11 | | 0.54 | 7.83 | 8.30 | 8.75 | 9.63 | 10.68 | 12.30 |
| 12 | | 0.51 | 8.46 | 9.01 | 9.58 | 10.61 | 11.83 | 13.53 |
| 13 | | 0.49 | 8.85 | 9.49 | 10.11 | 11.29 | 12.61 | 14.41 |
| 14 | | 0.47 | 9.11 | 9.83 | 10.55 | 11.96 | 13.58 | 15.81 |

Reverse Cable Equalizer

85 MHz Reverse Cable Equalizer Loss Table

| EQ Value (dB) | Part Number | Typical Insertion Loss (dB) at Various Frequencies (MHz) | |
|---------------|-----------------|--|-----|
| | | 5 | 85 |
| 0 | GS-REQ-85-00-05 | 0.8 | 0.4 |
| 1 | | 1.8 | 0.5 |
| 2 | | 2.8 | 0.5 |
| 3 | | 3.8 | 0.5 |
| 4 | | 4.8 | 0.6 |
| 5 | | 5.8 | 0.6 |
| 6 | GS-REQ-85-06-10 | 6.5 | 0.7 |
| 7 | | 7.6 | 0.7 |
| 8 | | 8.7 | 0.8 |
| 9 | | 9.7 | 0.8 |
| 10 | | 10.7 | 0.8 |

GainStar Line Extender Accessories Part Numbers

The following table provides part numbers for the GainStar Line Extender accessories.

| Attenuator Pad Value | Part Number |
|--|--------------------|
| 0 dB 1 GHz Plug-In Attenuator | 4036021 |
| 1 dB 1 GHz Plug-In Attenuator | 4036022 |
| 2 dB 1 GHz Plug-In Attenuator | 4036023 |
| 3 dB 1 GHz Plug-In Attenuator | 4036024 |
| 4 dB 1 GHz Plug-In Attenuator | 4036025 |
| 5 dB 1 GHz Plug-In Attenuator | 4036026 |
| 6 dB 1 GHz Plug-In Attenuator | 4036027 |
| 7 dB 1 GHz Plug-In Attenuator | 4036028 |
| 8 dB 1 GHz Plug-In Attenuator | 4036029 |
| 9 dB 1 GHz Plug-In Attenuator | 4036030 |
| 10 dB 1 GHz Plug-In Attenuator | 4036031 |
| 11 dB 1 GHz Plug-In Attenuator | 4036032 |
| 12 dB 1 GHz Plug-In Attenuator | 4036033 |
| 13 dB 1 GHz Plug-In Attenuator | 4036034 |
| 14 dB 1 GHz Plug-In Attenuator | 4036035 |
| 15 dB 1 GHz Plug-In Attenuator | 4036036 |
| 16 dB 1 GHz Plug-In Attenuator | 4036037 |
| 17 dB 1 GHz Plug-In Attenuator | 4036038 |
| 18 dB 1 GHz Plug-In Attenuator | 4036039 |
| 19 dB 1 GHz Plug-In Attenuator | 4036040 |
| 20 dB 1 GHz Plug-In Attenuator | 4036041 |
| Plug-In 75 Ω Terminator 3 - PIN | 4036140 |
| 3-State Switch Jumper | 4034473 |
| Power Shunt(black) | 4034476 |
| Power Shunt(red) | 4034477 |
| Signal Director | 4034468 |
| DC8 Directional Coupler | GS-1G-DC-08 |
| DC12 Directional Coupler | GS-1G-DC-12 |
| Test point probe | 1010409 |



Americas Headquarters

Cisco Systems, Inc.
170 West Tasman Drive
San Jose, CA 95134-1706
USA

<http://www.cisco.com>

Tel: 408 526-4000

800 553-6387

Fax: 408 527-0883

This document includes various trademarks of Cisco Systems, Inc. Please see the Notices section of this document for a list of the Cisco Systems, Inc. trademarks used in this document. Product and service availability are subject to change without notice.

© 2010, 2014 Cisco and/or its affiliates. All rights reserved.

October 2014

First Published: 10/31/2014