



## ADMINISTRATOR GUIDE

Cisco Configuration Assistant Release 3.0(1)  
Smart Business Communications System  
Administrator Guide

Cisco and the Cisco Logo are trademarks of Cisco Systems, Inc. and/or its affiliates in the U.S. and other countries. A listing of Cisco's trademarks can be found at [www.cisco.com/go/trademarks](http://www.cisco.com/go/trademarks). Third party trademarks mentioned are the property of their respective owners. The use of the word partner does not imply a partnership relationship between Cisco and any other company. (1005R)

<b>Chapter 1: Cisco Configuration Assistant Basics</b>	<b>15</b>
What is Cisco Configuration Assistant?	16
System Requirements	17
Downloading and Installing CCA	18
Checking for CCA Application Updates	19
CCA Version Compatibility Checking	20
User Interface	20
Menu Bar	22
Toolbar	24
Feature Bar	26
CCA Desktop	27
Dashboard	28
Topology View	32
Topology Options	39
Annotations	41
Front Panel View	41
Device and Link Status Icons and Graphics	44
Applying and Saving the Configuration	47
Viewing and Managing Errors	48
Voice Warning Messages	49
Setting Preferences	51
System Message Notifications	57
Create or Modify System Notification	58

---

Using Online Help	59
Printing CCA Windows, Reports, and Graphs	61
<b>Chapter 2: What's New</b>	<b>63</b>
Current Release	63
Recent Releases	64
<b>Chapter 3: Getting Started with the Configuration</b>	<b>75</b>
Creating and Managing Customer Sites	76
About Customer Sites	76
Customer Site Planning	77
Creating a New Customer Site	80
Connection Options	82
Modify a Customer Site	83
Adding a Device to an Existing Customer Site	84
Viewing and Listing Devices in a Customer Site	84
Managing Customer Sites	85
Connecting to a Site or Standalone Device	85
Using CCA Setup Wizards	89
Which Wizard Should I Use and When?	89
Telephony Setup Wizard	92
Security Setup Wizard	95
Wireless Setup Wizard	98
Device Setup Wizard	100
SR520-T1 Configuration Utility	101
Phone VPN Setup Wizard	101
Video Monitor Setup Wizard	104
Backing Up and Restoring Device Configuration	112
Using CCA with Cisco Small Business Office Manager	114
Resources for Planning and Implementing Your SBCS Solution	115
Cisco Small Business Support Community	115

Cisco Smart Designs	116
Cisco UC540 and UC560 Platform Reference Guides	116
Cisco SBCS Features Supported Within CCA	116

### **Chapter 4: Device Properties 119**

Hostname	119
System Time	120
Modify System Time	123
Network Time Server	124
Synchronize System Time	125
Time Zone (SA500 Security Appliances Only)	126
HTTP Port	128
Users and Passwords	129
Create User	132
Modify User Password	133
Modify Enable Password	134
Remote Device Access (Telnet)	134
SNMP	134
Create or Modify SNMP Filter (ESW500 Series)	138
Create SNMP View	140
Modify SNMP View	140
Create SNMP Group	141
Modify SNMP Group	142
Create SNMP User	143
Modify SNMP User	144

### **Chapter 5: Port and Switch Settings 145**

Switch Port Settings	145
Modify Port Settings	151
Modify Port Descriptions	151
Filter	152

Smartports	152
Modify Port Roles	154
Port Roles Details	156
Suggested Smartports	156
VLANs	157
Create VLAN	160
VLAN Synchronization	161
Port Mirroring (ESW500 Series Switches)	162
Spanning Tree Protocol (CE520 Switches)	163
IGMP Snooping (CE520 Switches)	166
Modify IGMP Snooping	167
MAC Addresses (CE520 Switches)	168
Port Search Window (CE520 Switches)	169
EtherChannels (CE520 Switches)	171
Create Port Groups	174
Modify Port Group	175
<b>Chapter 6: Routing and Network Connections</b>	<b>177</b>
IP Addresses	177
Internet Connection	182
Modify Internet Connection	184
DHCP Server	187
Create DHCP Exclusion	190
Create DHCP Pool	190
Modify DHCP Pool	191
Create DHCP Binding	191
Modify DHCP Binding	192
Static Routing	192
Add Static Route	193

<b>Chapter 7: Wireless</b>	<b>195</b>
Configuring Secure Wireless Settings	195
Create or Modify WLAN SSID	206
Wireless Security Options for AP541N Devices	209
Wireless Security Options for UC500W and AP521 Devices	213
Convert to LAP (Lightweight Access Point)	217
Conversion Settings	219
Conversion Status	220
Wireless LAN Controller Configuration	221
Configuring Wireless Interfaces for a WLAN Controller	221
Viewing Wireless Client Status for a WLAN Controller	224
Configuring WLAN Users	225
DHCP Proxy	230
Wireless Controller Dashboard	231
Configure RADIUS Server Settings for WLAN Controllers	233
<b>Chapter 8: Security Features</b>	<b>235</b>
NAT (Network Address Translation)	235
Overview	236
NAT Window (IP Addresses Assigned via DHCP)	237
NAT Window (Static IP or PPPoE with Static IP)	238
VPN Server	241
VPN Remote	246
Add a Network	248
Add an Account	248
Firewall and DMZ	249
Create DMZ Service	252
Firewall—Edit ACL	253
Security Audit	253
Network Security Settings (CE520 Switches)	255
Add a MAC Address	258

Modify a MAC Address	259
SSL VPN	259
Configure Port Forwarding List	266
Add a User Account	267
Add Intranet Websites	268
Install SSL VPN Client Software Window	268
Intrusion Prevention System (IPS)	269
URL Filtering (SR500 Series)	273
<b>Chapter 9: Telephony System and Region Settings</b>	<b>275</b>
Voice System Initialization	275
Voice System Settings	276
Region Settings for Telephony	277
<b>Chapter 10: Voice Ports and Trunks</b>	<b>281</b>
FXS Ports	281
PSTN Trunks	283
Configuring FXO Port Settings	288
Setting	293
Description	293
SIP Trunks	296
Trunk Status	301
<b>Chapter 11: Users and Extensions</b>	<b>303</b>
Users and Phones	303
User Extensions	304
Floating Extensions	315
Extension Mobility	317
Analog Extensions	327
Configuring Phone Button Assignments	328



Voicemail and Notifications	345
Single Number Reach (SNR)	357
Adding an SNR User	360
Modifying an SNR User	361
System Speed Dials	362

**Chapter 12: Phone Groups 365**

Hunt Groups	365
Call Blast Groups	368
Call Pickup Groups	370
Paging Groups	372
Paging Group Dependency View	377

**Chapter 13: Voice Features 379**

Call Park	379
Creating or Editing a Call Park Slot	380
Conference	382
Conference Barge	385
Music on Hold (MoH)	391

**Chapter 14: Call Handling 393**

Schedules	393
Auto Attendant	396
Prerequisites	397
Auto Attendant Configuration	397
Prompt Management	401
Script Management	403
Basic Automated Call Distribution (ACD)	404
Overview	405
Before You Begin	406
Configure Basic ACD Service	406

Create/Edit Basic ACD Parameters	407
Members of Hunt Group	410
Hunt Group Report Parameters	410
Night Service	411
Night Service Phones	414
Live Record	414
T.37 Fax to Mail	416
Overview	416
Limitations	417
Prerequisites for Configuring T.37 Fax	418
Enabling T.37 Fax to Mail and Configuring Services	419
Configuring Mailboxes for Incoming Faxes	423

## **Chapter 15: Dial Plan** **425**

Incoming Dial Plan	425
Direct Dial to Internal User Extensions	427
Direct Dial to Auto Attendant, Groups, Operator	429
Outgoing Dial Plan	430
Add Caller ID for Internal Extensions	440
Trunk Group Parameters	441

## **Chapter 16: Site Management** **443**

Multisite Manager	443
Multisite Design Requirements and Guidelines	443
Multisite Configuration Procedures	449
Prerequisites for Multisite Configuration	450
Adding and Configuring Sites	451
Site Settings	457
Configuring DDNS	460
Configuring Quality of Service (QoS)	461
Exporting and Importing Sites	463
Modifying a Site After the Initial Configuration	464

Deleting a Site	465
Multisite Status Monitoring	465
Voice Features Supported Across Multiple Sites	467
Maximum Calls (Call Admission Control)	468

## **Chapter 17: Applications** **471**

General Settings	471
Authentication URL	472
Services Menu Access	473
Call Accounting	475
HTTPS Authentication	476
Smart Applications Manager	477
Application-Specific Configuration	478
Unified Messaging (IMAP)	479
Video Telephony	479
Cisco WebEx PhoneConnect	480
TimeCardView	493

## **Chapter 18: Maintenance** **497**

Cisco UC500 Software and Locale Packs	497
UC500 Software Packs	498
UC500 Locale Packs	498
Downloading U500 Software and Locale Packs	499
View Software Version Information and Device Properties	500
Software Upgrades	500
Device Firmware Upgrade	500
Installing Software on the UC500	503
Software Upgrade Status	505
Voicemail Upgrade (UC560)	506
License Management	509
License Management Actions	513
Upload License File	517

Restart/Reset Devices	518
How to Localize the UC500 (Non-US/English Locales)	519
File Management	520
Phone Load Management	524

**Chapter 19: Monitoring** **529**

Network	530
Port Statistics	530
Bandwidth Graphs	534
Link Graphs	536
Wireless Usage	540
T1/E1/BRI Status	541
DNS and Hosts	541
Security	541
VPN Status	542
Telephony	543
Inventory	546
Inventory Details	547
System Log	547
Multisite Status	547
Health	547
Health Details	548
Event Notification	550
Notification Filter	552
System Messages	552
System Messages Filter	553

**Chapter 20: Troubleshooting** **555**

Circuit Diagnostics (T1 Loopback)	555
Network Diagnostics	557
Ping	558

Trace	559
DHCP Bindings	559
System Status	560
WAN Debug Log (SR520-T1)	560
Telephony Diagnostics	562
Dialplan Test	562
SIP Trunk Registration	564
Voice Troubleshooting Log	566
Phone Debug Log	568
PCM Capture	570
SCCP Analog Phones	571
CUE Connectivity Diagnostics	573
Security Diagnostics	576
Firewall/NAT Debug Log	576
VPN Debug Log	578
Generic Debugs	580
IOS Exec Commands	581
CUE Exec Commands	581
Generating a System Troubleshooting Log	582
Links and Connectivity (CE520 Switches)	583

## **Appendix A: Where to Go From Here** **585**

## **Glossary** **587**



# Cisco Configuration Assistant Basics

Welcome to Cisco Configuration Assistant!

- Click [here](#) for instructions on using the help system.
- See [Getting Started with the Configuration, page 75](#) for instructions on creating customer sites and using built-in device configuration wizards.
- See [Resources for Planning and Implementing Your SBCS Solution, page 115](#) for information about SBCS support community and partner resources.

If you are new to Cisco Configuration Assistant (CCA), the information in these sections will help you get started:

- [What is Cisco Configuration Assistant?](#)
- [System Requirements](#)
- [Downloading and Installing CCA](#)
- [Checking for CCA Application Updates](#)
- [CCA Version Compatibility Checking](#)
- [User Interface](#)
- [Applying and Saving the Configuration](#)
- [Viewing and Managing Errors](#)
- [Voice Warning Messages](#)
- [Setting Preferences](#)
- [System Message Notifications](#)
- [Using Online Help](#)
- [Printing CCA Windows, Reports, and Graphs](#)

---

## What is Cisco Configuration Assistant?

Configuration Assistant is an application for managing Cisco Small Business Pro platforms and devices. Devices can be managed standalone or in device groups, called *customer sites*, from anywhere in your intranet. Using its graphical interface, you can

- Set up a Cisco Smart Business Communications System (SBCS)
- Configure port connections
- Configure the telephony features of your customer site
- Manage telephony licenses on IP voice devices
- Set up network address translation, virtual private networks, and firewalls
- Configure the wireless LAN features of your customer site, including wireless security and wireless guest access
- Manage and audit network security
- View the entire customer site on a topology map
- View the front panels of managed devices
- Monitor device status, bandwidth, and links
- See inventory and status reports
- Upgrade software on devices
- Restart devices and reset devices to factory default configuration
- Back and restore site configuration

To perform any of these tasks, you select the appropriate feature from the CCA feature bar, as shown in the **“Feature Bar”** section on page 26.



## System Requirements

The PC on which you install CCA must meet these minimum requirements.

### System Requirements

<p><b>Operating Systems Supported (Windows)</b></p>	<p>Microsoft Windows Vista Ultimate (32-bit or 64-bit edition) Microsoft Windows XP Professional, Service Pack 2 or later Microsoft Windows 7 (64-bit and 32-bit)</p> <p>You must have write permission to your home directory and to the CCA installation directory so that CCA can create the necessary log files and preference files.</p> <p>For PCs running Windows Vista and Windows 7, Administrator privileges are required in order to update, install, and use CCA.</p> <p>When using CCA, on PCs running Microsoft Windows 7, set the auto sleep function to Never. To change the PC's setting follow these steps:</p> <ul style="list-style-type: none"> <li>▪ Go to <b>Control Panel &gt; Power Options</b>. By default, it is set to Balanced.</li> <li>▪ Click <b>Change when computer sleeps</b></li> <li>▪ Increase "Put computer to sleep" from 15 minutes (default) to <b>Never</b></li> </ul>
<p><b>Mac OS Support (requires virtualization software)</b></p>	<p><b>Mac OS:</b> 10.5 and later</p> <p><b>Virtual OS:</b> Parallels Desktop 3.0 and later or VMware Fusion 1.0 and later</p> <p><b>Guest OS:</b> Microsoft Windows XP (Service Pack 2 or later), Microsoft Windows Vista Ultimate. CCA also supports remote control via Virtual Network Computing (VNC) clients.</p>
<p><b>Hardware</b></p>	<p>PC with FastEthernet or higher LAN port</p>
<p><b>Processor</b></p>	<p>1.8 GHz Intel Core 2 Duo or higher</p>

---

### System Requirements

<b>Disk Space</b>	400 MB recommended
<b>Memory</b>	1 GB minimum, 2 GB recommended
<b>Display</b>	Screen resolution: 1280 x 1024 or higher recommended
<b>Browser</b>	Microsoft Internet Explorer 8.0 or later is recommended, with Javascript enabled.  The Adobe Flash Player 10 or later plug-in for Microsoft Internet Explorer must also be installed (in addition to any other version of the Flash plug-in that you may have installed for different Web browsers).  Javascript must be enabled for the Microsoft Internet Explorer browser.

## Downloading and Installing CCA

To install CCA on your PC, follow these steps:

- 
- STEP 1** Go to this web address: [www.cisco.com/go/configassist](http://www.cisco.com/go/configassist).
- You must be a registered Cisco.com user, but you need no other access privileges.
- STEP 2** In the Support information box, click the **Download Software** link.
- STEP 3** If you are not already logged in, you will be redirected to the Cisco.com Log In page. Enter your Cisco.com username and password to log in.
- STEP 4** Find the CCA installer file, for example, `Cisco-config-assistant-win-k9-3_0-en.exe`.
- STEP 5** Download the CCA installer and run it. You can run the installer directly from the web if your browser offers this choice.

CCA is free; there is no charge to download, install, or use it.

When you run the installer, follow the onscreen instructions. On the final page, click **Configure these settings from the Advanced tab.Finish** to complete the installation.

If you are using an older version of CCA, use the Application Update feature to upgrade to the latest version. See the **“Checking for CCA Application Updates” section on page 19.**

After CCA is installed, choose **Start > All Programs > Cisco Configuration Assistant > Cisco Configuration Assistant** or use the installed shortcut to launch CCA.

Since CCA is not connected to a customer site or device, only a few menu items and the Connect window are available after you first launch CCA. When CCA is not connected to a device or customer site, the menu bar and toolbar support only the tasks that customize CCA itself. The feature bar, which usually lists device features, is empty.

To connect to a device or create a customer site, see **Creating and Managing Customer Sites, page 76** and **Connecting to a Site or Standalone Device, page 85.**

## Checking for CCA Application Updates

You can keep CCA up-to-date by searching for and installing updates on Cisco.com.

In order to use the auto-update feature, you must a Cisco.com login on Cisco.com.

You are prompted to search for an update if

- CCA finds a new device type or a device with upgraded software among the devices it manages.
- You set up a periodic search in the Preferences window and the time interval has expired.
- The version of CCA you are using is older than the version that was previously used to configure the device or customer site to which you are connecting.

You can also search for an update on demand by choosing **System > Application Updates** from the menu bar.

If CCA finds an update, you can read a description of its contents and decide whether to install it.

## CCA Version Compatibility Checking

When you launch CCA and connect to a device or customer site, and the version of CCA you are using is older than the version of CCA that was previously used to configure that device or customer site, the CCA Version Conflict dialog appears.

The message “The version of CCA that you are using is older than the previous version that was used to configure this device. This may cause errors. Cisco strongly recommends that you upgrade to CCA version X.x or later. Do you want to upgrade now?”

If you choose **Yes**, you are prompted to enter your Cisco.com username and password to access CCA application updates.

## User Interface

The CCA user interface makes it easy to manage networking features and to request services from CCA itself. These are the main parts of the user interface:

- **Menu bar.** The row of menus across the top of the CCA window. It offers application services, a list of open windows, and online help. To learn more about the menu bar, see [Menu Bar, page 22](#).
- **Toolbar.** The row of icons directly below the menu bar. They represent the most often used application services and most often configured networking features. To learn what each icon represents, see [Toolbar, page 24](#).

- **Workspace.** The main area of the CCA window—everything between the toolbar and the status bar. It has two parts, the feature bar and the CCA desktop.
- **Feature bar.** The scalable panel on the left side of the CCA workspace in which you select features to configure and tasks to perform. If you do not know the name of a feature, you can search for it. To learn more about the feature bar, see [Feature Bar, page 26](#).
- **Desktop.** The right side of the CCA workspace, in which the Dashboard, configuration windows, and wizards appear. You view reports here and enter information that configures networking features. To learn more about the desktop, see [CCA Desktop, page 27](#).
- **Status bar.** The bar at the bottom of the CCA window. When CCA starts up, the status bar appears and progresses to the right as the devices in the network are learned. The status bar also indicates when voice data is loading. When this process ends, CCA is ready to use.

It repeats this learning process for every network polling interval. If you lose connectivity to the customer site or standalone device the status bar shows *No connectivity*.

- **Topology view.** A map of your network and much more, depending on the options that you select in the view. To learn more, see [Topology View, page 32](#).
- **Front Panel view.** A hierarchical list of the devices in your network, a wiring-closet graphic of the devices, and the status of each device and its ports. To learn more, see [Front Panel View, page 41](#).

## Menu Bar

The menu bar has features to help you use CCA. The features are grouped into these menus: System, Window, and Help.

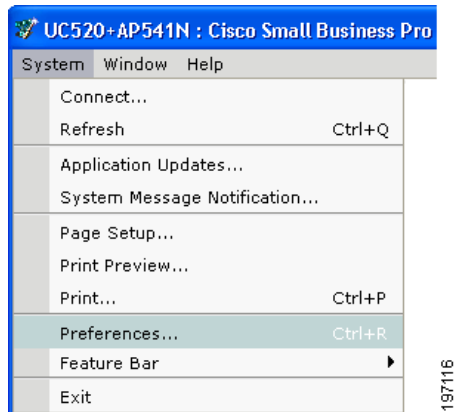

Menu	Feature	What You Can Do
<b>System</b>	Connect	Connect to a customer site or standalone device.
	Refresh	Refresh the Front Panel view and the Topology view by polling the site members.
	Application Updates	Check for application updates.
	System Message Notification	Receive email notifications of system messages.
	Page Setup, Print Preview, Print	Use standard printing options to print views, windows, and graphs.
	Preferences	Set CCA user preferences.
	Feature Bar	Set the feature bar viewing mode (Standard or Autohide).
<b>Window</b>	Choose a window from the list of open windows	Navigate to a window in a list of open windows.

Menu	Feature	What You Can Do
<b>Help</b>	Contents	See the help topic that introduces CCA.
	What's New?	See a list of the new features and enhancements that were added to CCA from release to release.
	Help For Active Window	See the help topic for the window or view that is active. You can also access help for the current window by pressing <b>F1</b> .
	Feedback	Send your feedback on CCA to Cisco.
	Startup Information	See a summary of new and changed features for the current release.
	Support Information	See how to contact the Small Business Support Center and how to generate a troubleshooting log file.
	About	See end user license information and the identifier for the version of CCA that you are using.

## Toolbar

The toolbar contains icons for the tasks that you perform most often. This table describes the actions that CCA takes when you click icons. Roll the mouse over the icons in the toolbar to display a tooltip that identifies each item.



Icon	Action
<b>Connect</b>	Opens the Connect window, where you identify a customer site or a standalone device for CCA to manage.
<b>Refresh</b>	Refreshes the Front Panel view and the Topology view by polling the customer site members. CCA updates the status of the devices and ports, and displays any new members.
<b>Print</b>	Sends a print file for a graph, a report, or online help selections to a printer.
<b>Preferences</b>	Opens the Preferences window, where you can set user preferences.
<b>Save Configuration</b>	Makes permanent the changes that you make to the device configuration; that is, your changes remain in effect after the device is powered off and powered on again.
<b>Users and Phones</b>	Opens the Users and Phones window, where you configure options for voice communication.
<b>VPN Server</b>	Opens the VPN Server window, where you configure a VPN server to send security policies to a device.
<b>Firewall and DMZ</b>	Opens the Firewall and DMZ window, where you configure a firewall or create a DMZ.
<b>Wireless Networks</b>	Opens the Wireless Networks window, where you configure security features on a WLAN controller and its associated access points.
<b>Smartports</b>	Opens the Smartports window, where you configure ports and devices by applying roles.



Icon	Action
<b>Switch Port Settings</b>	Opens the Switch Port Settings window, where you can view the status of ports on a selected device and modify port settings.
<b>Inventory</b>	Opens the Inventory window, which displays the inventory for the community—device types, serial numbers, IP addresses, and software versions—or the inventory for a single device.
<b>Health</b>	Opens the Health window, where you can monitor a number of device <i>health</i> measurements to avoid downtime and to ensure that your network is running efficiently.
<b>Event Notification</b>	Opens the Event Notification window, which describes network conditions that you should be aware of and that might require your action.
<b>Dashboard</b>	Opens the Dashboard window, which provides a graphical view of system health and status, including storage utilization on the UC500 flash, PoE utilization, temperature, events, voice mail, memory, and CPU utilization.
<b>Topology</b>	Opens the Topology view, which shows a network map of the community members, and much more, depending on the topology options that you choose.
<b>Front Panel</b>	Opens the Front Panel view, which shows a hierarchical list of the devices in the community, a wiring-closet graphic of the devices, and the status of each device and its ports.
<b>Legend</b>	Opens the online help to an explanation of the graphic conventions used in CCA.
<b>Help for Active Window</b>	Opens the online help to an explanation of the active window. If no window is active, the <i>Introduction</i> topic is shown.
<b>Feedback</b>	Opens a Web page where you can leave feedback on your experience with CCA.

You can also enter terms in field at the right of the toolbar and click **Search** to search the online help topics for the terms.

## Feature Bar

The feature bar is on the left side of the CCA desktop.

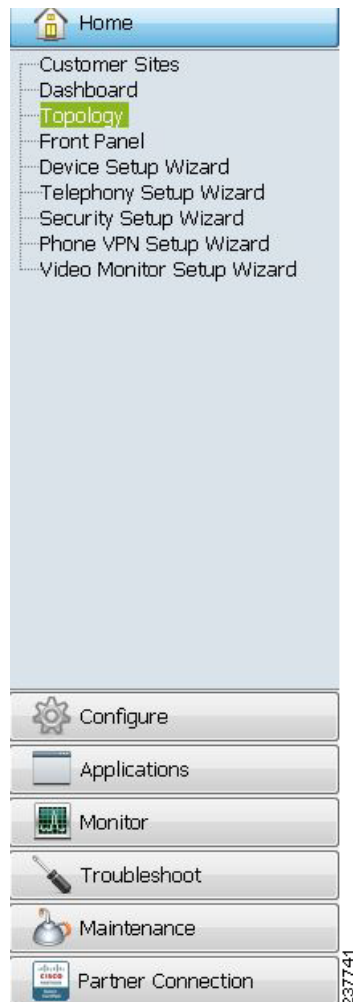

The features are grouped into these menus to identify categories of tasks:

- **Home**, for opening Dashboard, Topology, and Front Panel views, and running device, telephony, phone VPN, wireless, and other setup wizards.
- **Configure**, for configuring devices, ports, network routing, wireless LANs, security, and telephony features.
- **Applications**, for enabling and configuring setup options for Smart Applications or third-party applications.

- **Monitor**, for monitoring your network, viewing system and telephony status reports, and entering Cisco IOS and Cisco Unity Express (CUE) debug commands.
- **Troubleshoot**, for troubleshooting network and voice problems and creating logs that can be used by the Cisco Small Business Support Center to assist in troubleshooting and resolving system and network issues.
- **Maintenance**, for maintaining your network, upgrading software, managing licenses, managing phone loads, and managing files on the UC500.
- **Partner Connection**, for accessing the Cisco Small Business Support Community, UC500 product page, RSS feeds, UC500 software downloads, CCA VODs (video on demand), and the Partner Central site on Cisco.com.

When you select a feature on one of these menus, the content appears in a separate browser window.

### Standard Mode and Autohide Mode

The feature bar display can be set to standard mode or autohide mode:

- When the feature bar is in *standard mode*, you can narrow it to increase the space for windows on the CCA desktop. To do this, put the cursor on the right edge of the feature bar and drag the cursor to the left.
- When the feature bar is in *autohide* mode, it appears only when you move the cursor to the left edge of the CCA workspace. It disappears again when you move the cursor anywhere in the workspace outside the feature bar boundary.

To set the display mode for the feature bar, choose **System > Feature Bar** from the menubar and choose either **Standard Mode** or **Autohide Mode**.

## CCA Desktop

The CCA desktop is the focal point of the user interface. It is where you perform these tasks:

- Display the **Dashboard**, a graphical view of system health and status, including CPU utilization, PoE utilization, storage utilization on the UC500 flash, temperature, event alerts, VPN status, and voice mail.
- Display the **Topology View**, a network map of the customer site that CCA is managing. The view shows node information, link information, and neighboring devices.

- Display the **Front Panel View**, a picture of the front panels of the devices in the community. You can click the depicted devices and ports, and choose configuration options from a popup menu.
- Display setup wizards. Some setup wizards, such as the Telephony Setup Wizard, and the SR520-T1 Connectivity Wizard, are launched automatically when you connect to a device that is in factory default state.
- Enter information to configure networking features. You perform this task by using feature windows or guide-mode steps.
- Display reports and graphs. Look for the words Reports and Graphs in the menus on the feature bar. They accompany many of the networking and voice features offered there.

Launching a view by default when CCA connects to a device is preference that you can set. You can launch either view, both views, or neither. See [Setting Preferences, page 51](#).

## Dashboard

The Dashboard View requires Version 10.0.0.0 or later of the Adobe Flash Player and Microsoft Internet Explorer to be installed on the PC running CCA. Javascript must be enabled for the Microsoft Internet Explorer browser.

### Overview

The Dashboard displays in the main window area when you initially connect to a device or customer site with CCA. It provides an intuitive, at-a-glance, graphical display of system health and status for the Cisco Unified Communications 500 Series and other managed devices.

If you closed the Dashboard window, you can always re-open it by navigating to **Home > Dashboard**.

You can specify whether the Dashboard is automatically displayed when connected to the network. To access this setting, navigate to **System > Preferences**, click the General tab, and check or uncheck the **Show Dashboard When Connected to Network** option.

### Using the Dashboard

The Dashboard user interface consists of a series of windows and a palette from which you can drag and drop windows onto the main viewing area:

- Click **Show Palette** to display the palette. By default it is hidden.

- Use the left and right arrow buttons on the palette to cycle through available windows.
- Drag and drop or double-click icons on the palette to place windows on the display area.
- Position the mouse over items in the graphic display to view tooltips with numeric or percentage values.

Each Dashboard item window provides controls for:

- Minimizing and maximizing the window in the view
- Selecting a different device to view, if applicable
- Slideshow browsing mode, with pause and play controls

In slideshow mode, the display updates to display snapshot status information for each device at the specified browsing interval. If there is only one device, selecting slideshow mode has no effect on the display.

- Closing the window and moving it back to the palette
- Configuring window settings

For example, the Temperature dashboard window can be configured to display temperature in either degrees Celsius or Fahrenheit. Data refresh and slideshow browsing intervals can be configured for all windows.

To access configuration settings for dashboard windows, click the settings icon on the window bar.

Changes to the Dashboard view are saved across sessions.

## Available System Health and Status Displays

The table below lists and describes available system health and status windows.

Window	Description
<b>System Status</b>	<p>Displays general information for the selected device:</p> <ul style="list-style-type: none"> <li>▪ Hostname and device type</li> <li>▪ WAN IP address, subnet mask, and gateway IP address</li> <li>▪ DNS Server IP addresses</li> <li>▪ Cisco IOS version</li> <li>▪ Uptime</li> <li>▪ Date last updated</li> </ul>
<b>CPU Usage</b>	<p>Percentage of CPU capacity in use in the last 5 seconds, 1 minute, and 5 minutes for the selected device.</p>
<b>PoE Usage</b>	<p>Percent available and percent used power for PoE ports on the device.</p> <p>Position the mouse over the pie chart to view power consumption in Watts.</p> <p><b>NOTE</b> PoE usage is not currently displayed for ESW500 Series switches with PoE.</p>
<b>Flash Usage</b>	<p>Percent available and percent used storage for flash memory on the selected device.</p> <p>Position the mouse over the pie chart to view storage utilization in Mbytes.</p>
<b>Memory Usage</b>	<p>Percent available and percent used memory capacity for the selected device. Position the mouse over the pie chart to view memory allocation in Mbytes.</p>

Window	Description
<b>Events</b>	<p>Type and description for recent event notification alert messages.</p> <p>For more detail, navigate to <b>Monitor &gt; Event Notification</b>.</p> <p>You can also position the mouse over the event to view a tooltip with extended description and recommendation action.</p>
<b>Temperature</b>	<p>For devices that can measure precise temperature, temperature in degrees Celsius or degrees Fahrenheit.</p>
<b>Voicemail Status</b>	<p>Displays system and per-mailbox voicemail storage information and status, including:</p> <ul style="list-style-type: none"> <li>▪ Cisco Unity Express (CUE) version</li> <li>▪ Percent (%) used across the system</li> <li>▪ Per-mailbox information <ul style="list-style-type: none"> <li>- User ID/hunt group name associated with the mailbox</li> <li>- Extension</li> <li>- Type—Personal or GDM (General Delivery Mailbox)</li> <li>- Size—Amount of storage allocated, in minutes</li> </ul> </li> </ul>
<b>VPN Status</b>	<p>If EZVPN is configured, displays the public IP address, VPN IP address, and current status: Up - Active; Up - Idle, Up - No IKE, Down - Negotiating, or Down.</p> <p>VPN status can also be viewed by navigating to <b>Monitor &gt; Security &gt; VPN Status</b>.</p>
<b>Wireless Client (AP541N)</b>	<p>For a quick view of wireless client status, choose <b>Home &gt; Dashboard</b> to display the system dashboard, then drag and drop the Wireless Client item from the palette onto the main dashboard area. The Wireless Client dashboard item displays the MAC address, IP address, SSID, security type, and device type for associated wireless clients for AP541N access points. Wireless LAN controller status and AP521 status are not displayed on the dashboard.</p>

## Topology View

This view appears when you take any of these actions:

- Connect CCA to the devices that you want to manage.
- Choose **Home** > **Topology** on the feature bar.
- Click the Topology View icon on the toolbar.

### Overview

Use this view to see the topology of the devices that you manage and their connections. Use its parts—the **Toolbar**, the **Left Frame — Site Member Devices and Neighbors**, and the **Right Frame — Topology Map**—to perform **Tasks** that manipulate the view, save it, and give you information about the devices in it.

**NOTE** Cisco IP Communicator (CIPC) softphones are not displayed in the Topology view because there is no CDP (Cisco Discovery Protocol) information for softphones.

Right-click on icons in the Topology view to locating options for adding or removing a device from the customer site, opening the native device configuration utility, or performing other management tasks. See **Tasks, page 36**.

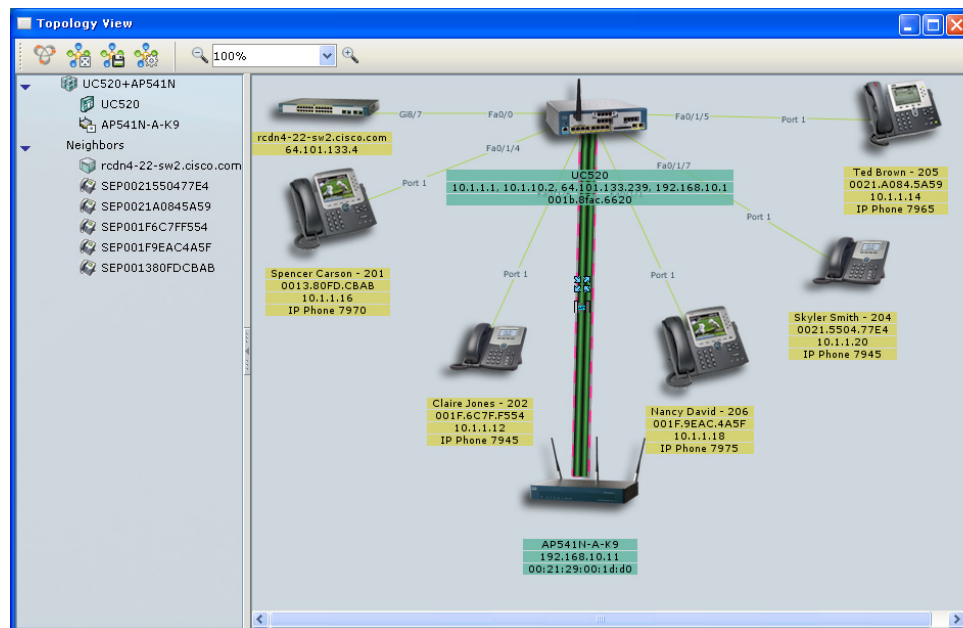



## Toolbar

The Topology view has its own toolbar. This table describes the actions that CCA takes when you use the toolbar options.



Option	How to Use It
<b>Discover Bonjour Devices</b>	Click to discover Cisco PVC2300 and WVC2300 video cameras and third-party printers with Bonjour support. Right-click on a Bonjour device and choose the Configuration Utility option to manage these devices using their built-in web management tools.
<b>Automatic Layout</b>	Click to redistribute the spacing and information in the view.
<b>Save Layout</b>	Click to save the locations of the devices in the topology map.
<b>Topology Options</b>	Click to launch the Topology Options window, in which you control what you see in the view. For example, you can control how much information is shown about links and nodes by using the check boxes on the <b>Show Information</b> tab. See <a href="#">Topology Options, page 39</a> .

Option	How to Use It
<b>Zoom Controls</b>	<p>Whenever the view is launched, the right frame appears at 100% magnification. To zoom out:</p> <ul style="list-style-type: none"> <li>▪ Click or hold down the “-” magnifier icon, or</li> <li>▪ Press “-” on the keyboard, or</li> <li>▪ Select a lower magnification from the drop-down list, or</li> <li>▪ Enter a number less than 100 in the text field.</li> </ul> <p>To zoom in again, use one of these methods:</p> <ul style="list-style-type: none"> <li>▪ Click or hold down the “+” magnifier icon.</li> <li>▪ Press “+” on the keyboard.</li> <li>▪ Select a higher magnification from the drop-down list.</li> <li>▪ Enter a higher number, up to 100, in the text field.</li> </ul>

You can choose any of the first three options from the menu that appears when you right-click anywhere in the background of the right frame.

### Left Frame — Site Member Devices and Neighbors

The left frame is a *tree diagram*. It shows an expanded list with the name of the customer site and each of the site members. There is also a list of neighbor devices of site members.



For a standalone device, the list shows only that device and its neighbors.

If you do not use a mouse, use the **Tab** key to select the tree, and then use the up and down arrow keys to move within it.

When you select a device in the tree view, the corresponding device is selected in the right frame, and the frame automatically scrolls to make the device visible.

## Device Status

The tree shows the status of devices by using these colors:

Color	Status
 Red	Down or not connected
 Green	Connected and operating
 Blue	Unknown

## Using the Popup Window

Right-clicking a device or pressing **Shift-F10** in the left frame opens a popup window. Its menu is a list of tasks—for example, viewing properties, changing the hostname, restarting a device, or seeing a bandwidth graph—that you can perform with the device. This is the same popup window that opens when you right-click a device in the right frame.

## Right Frame — Topology Map

The right frame is the *topology map*. It shows the links among the devices and gives link information. The rules that apply to it are the same as for the left frame:

- Its contents depend on whether you are managing a CCA customer site with multiple devices or a standalone device and whether you have asked to see neighboring devices in the Topology Options window.

- Right-click on a device icon in the Topology view to open windows for performing tasks with the selected device. You can also perform device-independent tasks that manipulate the view in this frame.

For example, the following menu is displayed when you right-click on the UC500 in the Topology view.

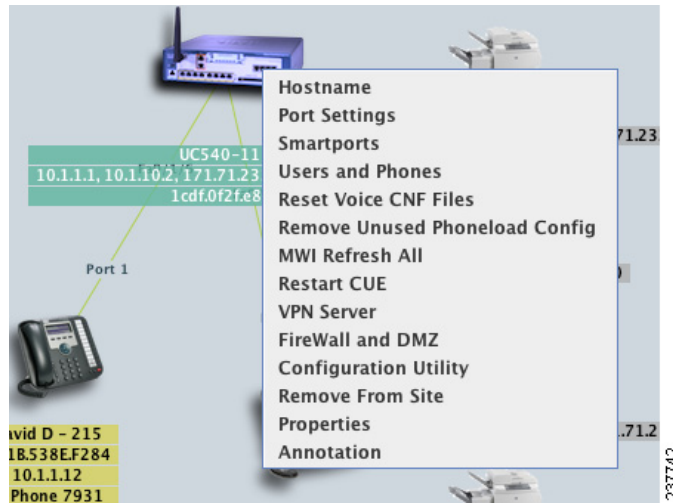

- Device status is shown by the same colors.

## Tasks

This table lists the tasks that you can perform from this view and tells you how to do them.

Task	How to Do It
<b>Rearranging the layout</b>	<p>To make devices, links, and information more visible in the view:</p> <ul style="list-style-type: none"> <li>▪ Drag devices to places that you prefer.</li> <li>▪ <i>Rubberband</i> devices that you want to move as a group; that is, hold down a mouse button, and draw a rectangle around them. When you drag one device, you then drag them all.</li> </ul>

Task	How to Do It
<b>Displaying device and link information</b>	<p>To display the properties of a device or link, right-click or double-click it, and choose <b>Properties</b> from the popup menu. The properties of a device are its name, type, IP address, MAC address, and the Cisco IOS release running on it. The properties of a link are the identities of the connected ports and the state of the link.</p> <p>To monitor the bandwidth that a device is using, right-click or double-click it, and choose <b>Bandwidth Graphs</b> from the popup menu. To monitor the use of a link, right-click or double-click it, and choose <b>Link Graphs</b> from the popup menu.</p>
<b>Showing VLANs</b>	<p>If you are managing multiple devices as part of a customer site, you can show VLAN links on the topology map. Click the options icon to open the Topology Options window, and use the <b>Show VLANs</b> tab.</p>
<b>Adding devices to a customer site</b>	<p>To add a device to a customer site, right-click or double-click any candidate, and choose <b>Add To Site</b> from the popup menu.</p>
<b>Removing devices from a customer site</b>	<p>To remove a device from a customer site, right-click any device, and choose <b>Remove From Site</b> from the popup menu.</p>
<b>Refreshing the view</b>	<p>When network polling is enabled, CCA periodically polls managed devices and re-displays the network topology when devices are removed or added. If you know that a change has occurred and you want to see the change between polling intervals, click the <b>Refresh</b> icon on the toolbar.</p> <p><b>NOTE</b> To enable or disable network polling and change the polling interval, use the Preferences window. See <a href="#">Setting Preferences, page 51</a>.</p>
<b>Resetting voice configuration (CNF) files</b>	<p>Choose <b>Reset Voice CNF Files</b> to have CCA regenerate the eXtensible Markup Language (XML) configuration files for IP phones so that they can refresh and recognize new settings. This may be needed after changing phone localization files.</p>

Task	How to Do It
<b>Removing unused voice configuration</b>	Choose <b>Remove Unused Voice Config</b> to remove phone load CLI that is not used from the configuration.
<b>Refreshing MWIs on all phones</b>	Choose <b>MWI Refresh All</b> to refresh the MWI (Message Waiting Indicator) on all phones to reflect the current state of voice mailboxes.
<b>Changing a hostname</b>	Right-click the device, choose <b>Hostname</b> from the popup window, and use the Hostname window.
<b>Annotating objects and links</b>	<p>You can add a field of text, referred to as an <i>annotation</i>, below devices and network clouds, and at the end points of links. An annotation is useful for displaying descriptive information that does not otherwise appear on the topology map.</p> <p>When you add a network cloud or link, the Annotation window opens. To annotate a device that is already on the map, right-click it, choose <b>Annotations</b> from the popup window, and use the Annotation window. See <a href="#">Annotations, page 41</a>.</p> <p>If you want to hide the annotations in the Topology view, open the Topology Options window, and uncheck <b>Annotations</b> on the <b>Show Information</b> tab.</p>
<b>Upgrading software</b>	<p>Drag and drop a software-image file from your PC to a device icon. (The device must be a member of the customer site.) The file can be on a mapped drive or a network drive, as well as on a local drive.</p> <p>To upgrade the software on more than one device at a time, use the Software Upgrade window.</p>
<b>Discovering Bonjour Devices</b>	Click the Bonjour icon on the Topology toolbar or right-click on the Topology view background and choose <b>Discover Bonjour Devices</b> to discover Cisco PVC2300 and WVC2300 video cameras and third-party printers with Bonjour support. Choose the Configuration Utility option to manage these devices using their built-in web management tools.

Task	How to Do It
<b>Adding a network cloud</b>	<p>Right-click the background of the topology map, and choose <b>Add Network Cloud</b> from the popup window. Give the cloud a label in the Annotation window that appears, and drag it to any map area that you like.</p> <p>You can change the label or remove the cloud by right-clicking it and choosing an action from the menu.</p>
<b>Adding a link</b>	<p>You can manually add a link to the map. Point at the node that you want to link from, press <b>Ctrl</b> and click, point to the node that you want to link to, and press <b>Ctrl</b> and click again. Then right click either node and choose <b>Add Link</b> from the popup window. A link is drawn between the nodes, and the Annotation window appears. In its fields, enter labels for the end points of the link.</p>

## Topology Options

This window appears when you select the Topology Options icon in the toolbar in the Topology view. Use the window to specify what you want to see in the Topology view.

Any device that runs the Cisco Discovery Protocol (CDP) will appear on the topology view. Not all of these devices can be managed with Configuration Assistant.

CCA has the ability to cross-launch the native device manager or configuration utility for certain devices, such as the SA500 Series secure routers and ESW500 Series switches. To launch the native device manager, right-click on the device in the Topology view and choose **Configuration Utility** from the drop-down list menu.

The window has these tabs:

- **Show Neighbors**, to select the neighbor devices that you want to see
- **Show Information**, to select the information about links and nodes that you want to see
- **Show VLANs**, to show VLAN links in the community and to select the colors that represent them

When you finish with the window, click **OK**.

## Show Neighbors

These check boxes control the neighbors that you can see:

- **IP Phones**—check to see full-featured telephones that provide voice communication over an IP network.
- **Other Neighbors**—check to see neighbor devices that are detected by CDP (Cisco Discovery Protocol) for example, access points and devices that CCA does not support as site members.

## Show Information

These check boxes control the information that is shown for links and nodes on the topology map:

- **Interface ID**—check to see the IDs of the interfaces to which the links are attached.
- **Actual Speed**—check to see the link speed information, as opposed to the administrative speed of a link.
- **Hostname**—check to see the hostnames of nodes.
- **IP Address**—check to see the IP addresses of nodes.
- **MAC Address**—check to see the MAC addresses of nodes.
- **Annotations**—check to see the annotations of links and nodes.

## Show VLANs

Follow these steps to show VLAN links on the topology map:

- 
- STEP 1** In the VLAN folder, click **Assign Color** for the VLAN whose links you want to highlight.
  - STEP 2** In the Color Selection window, click the highlighting color that you want to use, and click **OK**. The VLAN number moves above the VLAN folder to the list of VLANs that have a highlighting color. The **Assign Color** button becomes the **Modify Color** button and shows the color that you selected.
  - STEP 3** Check the box beside the VLAN number to turn on the highlighting color in the Topology view. If you uncheck the box later, the highlighting is turned off.
-



**Notes:**

- To change the highlighting color of a VLAN, click its **Modify Color** button, and select a different color in the Color Selection window.
- To remove the highlighting for a VLAN, click its **Remove Color** button. The VLAN's **Modify Color** and **Remove Color** buttons disappear, and the VLAN number returns to the VLAN folder with its **Assign Color** button.

**Annotations**

This window appears when you:

- Right-click a device on the topology map and choose Annotations in the popup menu.
- Add a network cloud.
- Add a link between nodes on the topology map; for example, between a device and a network cloud or between devices.

If you are annotating a node, enter descriptive information—for example, a device location—in the text field. The information appears below the node icon. If you are annotating a link, enter identifying information for each of the link endpoints. Click **OK** when you finish.

You can hide annotations on the topology map by unchecking Annotations on the Show Information tab of the Topology Options window.

**Front Panel View**

This view appears when you take any of these actions:

- Specify in the Preferences window that you want the Front Panel view to open when CCA is connected. See [Setting Preferences, page 51](#).
- Choose **Home > Front Panel** on the feature bar.
- Click the Front Panel View icon on the toolbar.

The view has two interrelated parts: the **Left Frame** and the **Right Frame**. Use them to **Select Devices** and to **Select Ports** so that you can check and change settings. You can also **Arrange Devices** in the view. To see the effect of changes, you can **Refresh the View**.

## Left Frame

The left frame is a tree diagram that shows member devices indented below a customer site name. Each device name has a box beside it. Check the box to see the front panel of the device in the right frame.

Not all devices have a front panel view. Also, unknown devices do not show a front panel view.

The tree diagram use these colors to show the device status:

- **Green.** The device is connected and operating.
- **Yellow.** A fault condition is detected. Move the mouse pointer over the device icon to see the fault-condition message.
- **Red.** The device is down or is not connected.

## Right Frame

The right frame displays the front panel view for the devices that you selected in the left frame. You see their ports and module slots as you would in a wiring closet.

## Select Devices

You can select a device in two ways:

- Click its front panel.
- Select the device icon in the tree diagram.

When you click a device, a yellow rectangle appears around it, showing that it is selected. To select multiple devices, hold down **Ctrl**, and click the devices that you want to select. To deselect a device, hold down **Ctrl**, and click the device that you want to deselect.

You can select a group of devices and then right-click a device to display a popup menu. Use the popup menu to check or change device settings. The popup menu options apply only to the selected devices. You can also use feature-bar options to check or change device settings. If a feature-bar option is not applicable to the selected devices, the selection is ignored.

## Select Ports

This table shows the options for selecting ports.

**NOTE** The ports on a WLAN controller cannot be selected.

If you want to...	Then...
Select a single port	Right- or left-click the port. Right-clicking pops up a menu as well.
Select all the ports on a device	Right-click any port, and choose <b>Select All Ports</b> from the popup menu.
Select multiple ports on the same device or on different devices	Use either of these methods: <ul style="list-style-type: none"> <li>▪ Hold down the <b>Ctrl</b> key, and click the ports that you want to select.</li> <li>▪ <i>Rubberband</i> the ports that you want to select; that is, hold down a mouse button and draw a rectangle around a group of ports. If you also hold down the <b>Ctrl</b> key, you can add non-adjacent groups of ports to the selection.</li> </ul>

To deselect a port, hold down the **Ctrl** key and click the port that you want to deselect.

When you right-click to select a single port, a popup menu appears. To see a popup menu when you select more than one port, you must right-click one of the ports. Use the popup menu to check or change port settings. The popup menu items apply only to the selected ports. You can also use feature-bar items to check or change port settings. If a feature-bar item is not applicable to the selected ports, the selection is ignored.

### Arrange Devices

You can change the order of the devices to reflect the physical setup in your wiring closet. To reposition a device, drag its icon in the tree diagram to a new position.

### Refresh the View

To refresh the Front Panel view, click the Refresh icon on the toolbar. This action is useful if you know that a change has occurred in the site and you want to see it immediately.

## Device and Link Status Icons and Graphics









This section explains the graphics and colors that appear on the Topology view, on the Front Panel view, and in the configuration windows. The explanations are divided into these categories:

- **Device Icons**
- **Device Status Icon and Label Colors**
- **Port Types**
- **Link Types**
- **Link Status**







### Device Icons

These device icons commonly appear in CCA views and windows.







- A device icon is red when the device is down.
- An Unknown device icon appears when CCA does not support a device or does not support the Cisco IOS version that the device is running.

Icon	Device	Icon	Device
	Customer Site		800 Series access router
	Unified Communications 500 Series Platform		IP phone
	Switch (ESW500 Series or Catalyst Express CE520)		Wireless LAN controller
	Autonomous Access Point		Lightweight Access Point





You might also see these icons in the topology map:

Icon	Device	Icon	Device
	Stack		Modular switch
	Layer 3 switch		LRE Switch
	Unknown		Network Cloud

### Device Status Icon and Label Colors











<b>Icon Color</b>	 Up	 Down	 Unknown
<b>Label Color</b>	 Member or Standalone Device	 Candidates	 Edge Device

### Port Types

 RJ-45	 RJ-45	 RJ-11
 Small form-factor pluggable (SFP) module (empty)		
 SFP fiber-optic module (LX, SX, ZX, CWDM, 100BASE-FX)		

## Link Types

**NOTE** The two pipes represent two or more links. If one pipe is gray and the other is green, one or more links are blocked, and one or more are up.

Icon/Link Type		Icon/Link Type	
	10 Mbit (blocked)		Gigastack
	100 Mbit		Trunk
	1 Gbit		Routed
	10 Gbit		Edge
	Etherchannel		Multiple Links
	Manually Added Link		

## Link Status

<b>Link color</b>	 Up	 Blocked
-------------------	--	---

---

## Applying and Saving the Configuration

The Save Configuration window appears when you exit CCA or choose **Configure > Save Configuration** on the feature bar.

### Overview

When a network device with Cisco IOS is running, it has two sets of configuration settings. One is its startup configuration, which is stored in flash memory. The other is its running configuration, which is stored in RAM. The device uses the running configuration to determine its behavior.

- When you click **OK** or **Apply** in a configuration window, you make changes to the running configuration. These changes go into effect immediately.
- When you choose **Configure > Save Configuration** or click **OK** when prompted to save the configuration on exit, you are saving changes to the startup configuration for the selected devices. This ensures that the changes are preserved if the device is restarted.

You can use CCA to save the running configuration as the startup configuration, which makes permanent any changes that you make to the running configuration.

Saving the running configuration does not save changes that you make in the Topology view. To save the settings in the Topology view, go to **Home > Topology** and choose **Save Layout** on the Topology view toolbar.

### Procedures

- To save the running configuration of a managed device to its startup configuration, select the device from the Hostname list and click **Save**.
- To save the running configurations of all the managed devices, select **All Devices** and click **Save**.

## Viewing and Managing Errors

CCA lets you know when you enter valid information by putting a green border around it.

- Any changed information appears in the status bar.
- When you apply a change, the green border disappears.

### Error Management

If you enter invalid information when configuring fields in CCA:

- You see a red border around the fields that contain errors.
- In tabbed windows, the number of errors on each tab is displayed in the tab heading in red.
- The error management bar automatically displays at the bottom of the window.

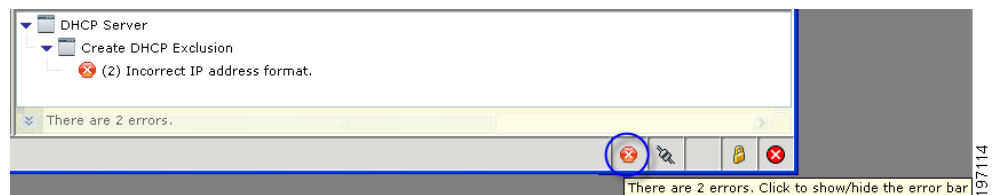

The error management bar provides a central location for viewing and handling errors as you enter and apply configuration in CCA.

All current errors in open windows are listed, along with the window name, associated dialog (if the error is displayed in a popup dialog), and the associated error message details. The total number of errors in all open windows is displayed at the bottom of the error management bar.

As you resolve errors, the error management bar updates to indicate that the error has been resolved. When all errors are resolved, it closes automatically.

When working with the error management bar:

- Click the arrow buttons in the window hierarchy to navigate the list of errors in each window.
- Click on an error message to bring the associated window into focus and highlight the field with the error.



- To resize the error management bar, left click and drag the mouse over the top border of the bar.
- To show or hide the error management bar, click the error icon at the bottom of the window.

If CLI Postview is enabled (see the Advanced tab in the Preferences dialog), the configuration commands sent to the UC500 or SR500 are displayed in a pop-up window. See [Setting Preferences, page 51](#).

## Voice Warning Messages

The Voice Warning Messages window is displayed when you attempt to access or configure voice features, but your system does not meet one or more required conditions.

Before continuing, make sure that the following conditions are met.

Warning Message	Required Action	Related Feature or Window
<p><b>Reset the system to factory default configuration</b></p>	<p>To run the Telephony Setup Wizard, you must first reset the UC500 to factory default configuration. This can take up to 20 minutes.</p> <p>To reset the UC500 to factory default configuration:</p> <ol style="list-style-type: none"> <li>1. From the feature bar on the left, choose <b>Maintenance &gt; Restart/Reset</b>.</li> <li>2. In the Restart/Reset window, select the Cisco UC500, check the <b>Reset to Factory Default Configuration</b> option, and click <b>OK</b>.</li> <li>3. When the reset is completed, re-launch the Telephony Setup Wizard.</li> </ol>	<p>Telephony Setup Wizard</p>
<p><b>Make sure that your PC is directly connected to a LAN port on the UC500</b></p>	<p>To run the Telephony Setup Wizard, the PC running CCA must be directly connected to a LAN port on the UC500 and obtain an IP address from the UC500 using DHCP.</p>	<p>Telephony Setup Wizard</p>

Warning Message	Required Action	Related Feature or Window
<p><b>Disable any third-party TFTP service running on your PC</b></p>	<p>If the feature that you are trying to access requires CCA to use the built-in TFTP or FTP service to transfer files to or from the UC500, you must first disable any other third-party TFTP or FTP services running on your PC before continuing.</p> <p>If you are using a Windows-based PC, you can use Windows Task Manager to locate these applications and close them. However, these services might not be shown on the Applications tab in the Task Manager.</p> <p>You can also open a command window on your PC and issue the <code>netstat</code> command to see if these services are running and identify them by executable name and process ID. For example:</p> <pre>c:\ netstat -a -b</pre> <p>Once you locate the third-party TFTP or FTP process, you can go to the Processes tab on the Windows Task Manager and manually shut it down by highlighting the process in the list and choosing <b>End Task</b>.</p> <p>For more information, consult the documentation for your operating system, TFTP application, or FTP application.</p> <p>If there are no third-party TFTP services running, check the firewall and network security settings on your PC to make sure that TFTP traffic is allowed between the PC and the UC500 or try restarting your PC to release TFTP ports from a prior CCA session.</p>	<p>Drag and drop files from PC onto the Topology View (Cisco IOS images, MoH files, Basic ACD scripts, Auto Attendant scripts</p> <p>Telephony Setup Wizard</p> <p>Configure &gt; Telephony &gt; Call Handling &gt; Auto Attendant</p> <p>Configure &gt; Telephony &gt; Call Handling &gt; Basic ACD</p> <p>Configure &gt; Telephony &gt; Users and Extensions &gt; System Speed Dial</p> <p>Maintenance &gt; Configuration Archive</p> <p>Maintenance &gt; Software Upgrade</p> <p>Maintenance &gt; License Management</p> <p>Maintenance &gt; Restart/Reset (Reset to Factory Defaults option only)</p>

## Setting Preferences

To configure preference settings for CCA:

- Choose **System > Preferences** on the menu bar.
- Click the Preferences icon on the toolbar.

### Overview

You can customize much of what CCA does. For example:

- Choose whether to display the Topology view, Front Panel view, or Dashboard windows when you connect to your network using CCA.
- Enable or disable network polling and specify how often CCA polls the devices it manages to provide up-to-date information.
- Specify how often to check Cisco.com for a newer version of CCA.
- Choose whether you want to use a proxy server to download CCA application updates from Cisco.com.
- Specify the location for archiving saved configurations on the devices that you manage.
- Specify options for system health monitoring.
- Enable or disable display of Cisco IOS commands sent to the router for telephony configuration changes (CLI Postview window).
- Choose whether or not the Cisco.wav file is played at startup.
- Choose the desktop background image.
- Enable or disable collection and upload of CCA usage activity to Cisco.
- Enable or disable the display of CLIs which are sent to the devices and the display of timestamp in the console window.

When you exit from CCA, your preferences are saved to your PC in a file named `.user_preferences`. It is stored in this location:

```
C:\Documents and Settings\<username>\.configuration assistant
```

You can copy it to other PCs.

The settings on each of the tabs in the Preferences window are explained in the next sections, with their defaults. If you change the defaults, click **Set Defaults** to restore them.

### General

On the General tab, you can set these polling and start-up preferences.

Setting	Description
<b>Enable Network Polling</b>	<p>By default, network polling is disabled.</p> <p>When this option is enabled, CCA periodically polls the network to determine device status and discover new devices. The polling information is used to refresh the Topology view, the Front Panel view, and many of the feature windows.</p> <p>When network polling is disabled, click the <b>Refresh</b> icon on the CCA toolbar to manually trigger network polling.</p>
<b>Network Polling Interval</b>	<p>When network polling is enabled, this setting specifies how often CCA polls the network. The default is 5 minutes. This setting is inactive when network polling is disabled.</p>
<b>LED Polling Interval</b>	<p>How often CCA polls the LEDs of the managed devices. At each interval, CCA displays interface and RPS information using colored LED icon in the Front Panel view. You can click the button on the left of the view to specify the kind of information that each color represents—link status, port speed, duplex state, or power state. The default is 3 minutes.</p>
<b>Graph Polling Interval</b>	<p>How often CCA queries the managed devices to obtain device- and link-utilization data. This information is used to update the link and the bandwidth graphs. The default is 5 seconds.</p>
<b>Show Topology View when connected to network</b>	<p>Whether the Topology view appears when CCA is connected to a device. It is checked by default.</p>

Setting	Description
<b>Show Front Panel View when connected to network</b>	Whether the Front Panel view appears when CCA is connected to a device. It is unchecked by default.
<b>Show Dashboard when connected to network</b>	Whether the Dashboard view appears when CCA is connected to a device. It is checked by default.

### Application Updates

Specify how often to search for a newer version of CCA.

In the **Check for application updates** list, choose **Monthly**, **Weekly**, or **Never**. If you choose **Never**, CCA makes no periodic checks. However, you can check on demand by choosing **System > Application Updates** on the menu bar.

### Proxy Servers

On this tab, you show whether you want to use proxy servers to communicate with Cisco.com to look for a newer version of CCA.

To upgrade CCA to a newer version, follow these steps.

- 
- STEP 1** Check **Enable proxy servers** to enable communications through proxy servers. When you check this box, you can use the other fields on the tab.
- STEP 2** Check **Use proxy servers to manage devices** to communicate with your network through proxy servers.
- STEP 3** To show that HTTP traffic will use a proxy server, enter these values in the **HTTP** fields:
- The IP address or hostname of the proxy server
 

You can use a hostname to identify a proxy server only if a DNS server has been set up to resolve the hostname.
  - The number of the HTTP port
- STEP 4** To show that HTTPS traffic will use a proxy server, enter the appropriate values in the **HTTPS** fields.
-

## Configuration Archive

On this tab, you set preferences for backing up a saved configuration on a device.

Follow these steps:

- 
- STEP 1** Check **Save configuration on the device before backup** if you want CCA to save the running configuration on the device before it backs it up as the saved configuration.
- STEP 2** In the **Backup Directory** field, replace the path that is used for backing up configurations if you want them to be backed up on some other path.
- 

## Health

Check the boxes for the health categories that you want CCA to monitor.

The **Health Polling Interval** determines how frequently you want updates to the measurements in the Health window and the Health Details window.

## Usage Activity

The usage activity tracking feature is designed to automatically provide feedback on how CCA is being used to deploy Cisco SBCS devices. The data shared by this feature helps Cisco to improve the quality of the software.

Usage activity tracking is enabled by default, as described in the End User License Agreement (EULA) for CCA. To view the EULA, choose **Help > About** from the CCA main menu and click the End User License Agreement link.

Uncheck the **Enable usage activity collection** option to disable collection and transmission of CCA usage data to Cisco.

When this option is enabled, only these usage activity statistics are collected:

- CCA version and internationalization
- Types of devices being managed by CCA
- Software version for each managed device (for example, Cisco IOS version, switch firmware version, and Cisco Unity Express (CUE) software version)
- User actions
  - Feature window launch
  - Tab navigation events in feature windows and dialogs

- When CCA applies a configuration to a device  
No details of the configuration are recorded, only that the user applied a change to the configuration.
- Public IP address of the PC on which CCA is installed and from which the data is sent.  
This is the WAN or Internet IP address maintained and allocated by your Internet Service Provider (ISP) to the router or firewall at your site.
- Timestamp for each event
- VLAN usage
  - Whether or not the default IP address is used for VLAN1 on the UC500 (192.168.10.x). CCA does not record the VLAN1 IP address; it only checks to see if the default value is being used.
  - Total number of VLANs
- Smartport usage: Type of Smartport roles applied
- VPN usage: Types of enabled VPNs (EasyVPN, SSL VPN, or site-to-site VPN). Phone VPNs are not tracked.
- SIP trunk usage
  - Whether or not SIP trunking is enabled
  - If enabled, the selected SIP trunk provider
- Wireless usage
  - Whether or not wireless is enabled
  - Type of wireless security used
  - Total number of SSIDs configured
- UC500 flash usage: Available flash space and total flash space in Mbytes

The following information is NOT collected:

- Customer names, addresses or other identifying information
- Product serial numbers or other unique identifiers
- Hostnames or IP addresses for devices that are behind the router or firewall at your site

- Phone numbers or any other information that could be used to uniquely identify a customer or VAR
- Cisco.com usernames or passwords
- Usernames or passwords configured on the device

Usage activity data is stored in a text file on the PC running CCA and is sent to a server hosted by Cisco on a per-session basis. After the information is sent, it is removed from the user's PC.

An Event Notification alert is generated each time usage activity data is sent.

### Logging

On the Logging tab, you can set the preferences for what information is displayed in the CCA log files and in the CCA Console window.

Setting	Description
<b>Logging Contents</b>	<p>These settings control display of CLI information in log files and timestamp information in the CCA Console window.</p> <ul style="list-style-type: none"> <li>▪ CLI information is displayed in CCA log files by default. This option is enabled by default at application launch. To disable display of CLI information in log files, uncheck the <b>Check Enable Display of CLI in Log</b> option. If the user exits CCA and relaunches it, this option will be enabled by default.</li> <li>▪ This option is enabled by default at application launch. To disable display of timestamp information in the CCA Console window, uncheck <b>Enable Display of Timestamp in Console</b> (to open the CCA Console window, press F2). If the user exits CCA and then relaunches it, this option will be enabled by default.</li> </ul>

### Advanced

Configure these settings from the Advanced tab.



Setting	Description
<b>Enable startup sound</b>	Check <b>Enable startup sound</b> if you want to hear the Cisco .wav file at startup.
<b>Enable CLI postview of IOS voice features</b>	Check <b>Enable CLI postview of IOS voice features</b> if you want to view a list of Cisco IOS commands sent to the router after configuration changes are made in a configuration window. The commands are displayed in a popup window after the changes are applied.
<b>Desktop Background Image</b>	To select a different background image click <b>Browse</b> and navigate to the location of the desired file on the local PC, then click <b>OK</b> or <b>Apply</b> .  Image types supported include .png and .jpg  If the image exceeds the desktop size it will be clipped. If the image is too small it will use a “Tile” style display.

## System Message Notifications

The System Message Notification window appears when you choose **System > System Message Notification** from the CCA menubar.

You can receive e-mail notifications of system messages that you want to know about. The system messages can be about any customer site events, from emergencies and alerts (severity levels 0 and 1) to informational or debugging messages (severity levels 6 and 7).

To activate this feature, you must:

- Enable an SMTP server to send e-mail notifications of system messages
- Create a notification name

To set up system message notifications, follow these steps.

- 
- STEP 1** In the **E-mail Server (SMTP)** field, enter the name of the SMTP server that will send out notifications.
- STEP 2** In the **Sender E-mail Address** field, enter an e-mail address for SMTP to show as the sender of the notifications. In SMTP terminology, this address is the return address.
- STEP 3** Click **Test E-mail** to test the connection between the SMTP server and the sender e-mail address. If the sender receives the test e-mail, the connection is verified.
- STEP 4** Click **Create** and use the Create Notification window. See [Create or Modify System Notification, page 58](#).

When you are done, the new notification name appears in the Notification List and its Active box is checked.

- STEP 5** Click **OK** or **Apply**.

---

To modify the information for a notification name, select the name, click **Modify**, and use the Modify Notification window.

To delete a notification name, select it, and click **Delete**.

## Create or Modify System Notification

This window appears when you click **Create** or **Modify** on the System Message Notification window. Use it to specify:

- A notification name
- The e-mail address of recipients
- The kinds of messages, by severity level, that the recipients want to know about

To create or modify a system notification, follow these steps:

- 
- STEP 1** Enter or edit the name in the **Notification Name** field.
- STEP 2** Enter or edit the e-mail address in the **E-mail Address** field. This is the address at which recipients will receive notifications.
- STEP 3** Specify the kinds of messages that the recipients want to know about by checking the boxes beside the severity levels of those messages.

Checking a severity level number higher than 3 might cause recipients to receive more notifications than they want.

**STEP 4** Click **OK**.

## Using Online Help

CCA online help displays in a separate Web browser window that provides:

- Toolbar with Back, Forward, and Home navigation buttons, Print PDF button, and Search text box
- Contents and Index links on the left
  - By default, the Contents list is displayed. Click the Index link to go to the help index.
  - Click the Book icons to expand and collapse the topic list.
  - While in the Index view, you can enter a word or phrase in the search box above the Index list to search the Index entries.
- Current help topic on the right

For best results, enable JavaScript in your Internet Explorer browser. If prompted in the Information Bar, choose the option to allow blocked content so that you can view and use the help navigation and interface controls.

### Access Online Help

To access online help:

- Click **Help** in a window or dialog
- Press **F1** to access help for the active window
- Choose one of these Help menu options from the menubar at the top of the main window:
  - **Contents**. Displays the introduction to CCA topic.
  - **What's New**. Displays links to information about new features in the current release and recent releases.

- **Help for Active Window.** Displays online help for the active window. If multiple windows are open, the active window is the window that currently has focus.

### Search Online Help

To search the online help, enter a word or phrase in the search box in the top right corner of the online help window, then click **Go**. Partial matches are supported, but wildcard search characters and patterns such as (\*) and (.) are not supported.

Once you click **Go**, the page updates to display the search results.

- Click on a topic link to display the topic that contains matches for the specified keyword. Matches are highlighted on that page.
- Click the icon to open the topic in a new window, allowing you to easily return to the search results page.

### Open a PDF of the Online Help

Click the **PDF** button on the Help window toolbar to open a PDF that contains the entire contents of the online help in PDF format.

This allows you to save or print a copy of the Help for offline viewing.

### Print Help Topics

Click the **Print** button on the Help window toolbar to print the current topic.

To print information in CCA windows, you can use the Java printing system. See [Printing CCA Windows, Reports, and Graphs, page 61](#).

---

## Printing CCA Windows, Reports, and Graphs

To print a CCA window, view, or graph, follow these steps.

- 
- STEP 1** Make sure that the object that you want to print is active.
- STEP 2** Choose **System > Print** from the menubar to send a print file to a printer.
- 

When you print a window, the printout is in a report format. In this format, none of the window information is truncated, as can happen if you use the **PrtSc** key to print the screen. The report format is also time-stamped, and pages are numbered.

### Notes

- The Telephony Setup Wizard, Wireless Setup Wizard, Multisite Manager, Video Monitor Setup Wizard, Security Setup Wizard, Phone VPN Setup Wizard, and Dashboard windows cannot be printed.
- If the object that you want to print becomes inactive because of a popup error message, you cannot print it until you close the error dialog and make it active again.
- To print a child window (a secondary window that opens when you click a button on the parent window), it must be open and active.
- When you print the Topology view or the Front Panel view, the Print Preview window (**System > Print Preview**) has a **Fit To Page** option. Check it if you want the view to be printed on a single page.



## What's New

For information about new features and supported devices in Cisco Configuration Assistant, see these topics:

- [Current Release, page 63](#)
- [Recent Releases, page 64](#)

## Current Release

### Release 3.0(1)

Release 3.0(1) of CCA is a maintenance release that resolves known issues found in CCA 3.0.

Feature	Description
<b>Voice Feature Configuration</b>	
<b>Extension Mobility Status</b>	<p>This is a new window for viewing Extension Mobility phone information, profile information, and status (<b>Monitor &gt; Telephony &gt; Extension Mobility Status</b>).</p> <p>This information is read-only; to configure these settings please see <a href="#">Extension Mobility, page 317</a>.</p>
<b>User Interface Changes and Enhancements</b>	
<b>Custom Desktop Background</b>	<p>Enables the user to specify a customer CCA desktop background image from the <b>System</b> menu chose <b>Preferences...</b> then click the <b>Advanced</b> tab).</p> <p>To configure additional preference settings for CCA please see <a href="#">Setting Preferences, page 51</a>.</p>

---

## Recent Releases

### Release 3.0

Release 3.0 of CCA is a major release of the software that includes these new features and user interface changes.

See the *Release Notes for Cisco Configuration Assistant Release 3.0* for a list of known issues that were resolved in this release and current information about UC500 software packs and locale packs.



Feature	Description.
<b>Device Support</b>	
<b>Cisco Model 69xx IP Phone Support</b>	CCA 3.0 supports configuration of Cisco Model 6901, 6911, 6921, 6941, and 6961 IP phones. Drag-and-drop phone firmware upgrades are also supported for these phones.
<b>Software and Locale Pack</b>	
<b>UC500 Software Pack Version 8.1.0 Support</b>	CCA 3.0 supports UC500 software pack version 8.1.0. For more information, see the <i>Release Notes for Cisco Configuration Assistant Version 3.0</i> . See <a href="#">UC500 Software Packs, page 498</a> .
<b>UC500 Locale Pack Support</b>	CCA 3.0 supports installation of localization files via UC500 locale packs. UC500 locale packs can be downloaded from Cisco.com at <a href="http://www.cisco.com/go/uc500swpk">www.cisco.com/go/uc500swpk</a> . Each locale pack contains phone language files, voice mail language files, network tones, and cadences for a given locale. See <a href="#">UC500 Locale Packs, page 498</a> .
<b>Voice Feature Configuration</b>	
<b>Extension Mobility</b>	Enable Extension Mobility (EM) and configure global site settings, EM user profiles, and EM phone profiles. This feature allows users to log in any EM phone and be able access line appearances, voice mailbox, and speed dials. See <a href="#">Extension Mobility, page 317</a> .
<b>Floating Extensions</b>	Add extensions that are not associated with a physical phone. See <a href="#">Floating Extensions, page 315</a> .
<b>Voicemail Notifications</b>	Globally enable notification of voice mail messages via email or phone and configure user notification settings. See <a href="#">Voicemail and Notifications, page 345</a> .
<b>T.37 Fax to Email</b>	Store T.37 faxes to voice mail and forward them as email attachments. <a href="#">T.37 Fax to Mail, page 416</a> .

Feature	Description.
<b>SNR Timeout</b>	Configure timeout settings for Single Number Reach (SNR). The SNR window is now located under <b>Configure &gt; Telephony &gt; Users and Extensions &gt; Users and Phones</b> . See <a href="#">Single Number Reach (SNR), page 357</a> .
<b>Call Park timeout and recall</b>	Specify timeout and recall settings for parked calls. See <a href="#">Call Park, page 379</a> .
<b>Call Hold Audible Alert</b>	You can set up an audible, repeating alert tone to notify the user when a call is placed on hold on a Cisco IP phone. See <a href="#">Call Hold Alert Tab, page 332</a> .
<b>FXO Port Details Settings</b>	Configure detailed FXO port settings for companding type, supervisory disconnect, battery reversal, audio, and timers. You can also copy port settings. See <a href="#">Configuring FXO Port Settings, page 288</a> .
<b>Live Record Beep Tone</b>	Configure beep tone duration and interval settings for Live Record. See <a href="#">Live Record, page 414</a> .
<b>Improved Bulk User and Phone Data Import</b>	Perform a bulk import of user and phone data from either the Telephony Setup Wizard or the Users and Phones window. The procedures for preparing and importing user data have changed from prior releases. See <a href="#">Importing Phone Data for Multiple Users (Bulk User Import), page 310</a> .
<b>Network Configuration</b>	
<b>Static NAT Mapping</b>	If the WAN connection is configured with a static IP address or PPPoE negotiated IP address, you can configure static NAT mappings. See <a href="#">NAT Window (Static IP or PPPoE with Static IP), page 238</a> .
<b>Modified VLAN Creation Steps</b>	The interface for creating and configuring VLANs has been modified. You configure IP addressing for VLANs from the VLAN window and set the default Voice LAN. See <a href="#">VLANs, page 157</a> .

Feature	Description.
<b>Maintenance</b>	
<b>Simplified UC500 Localization, Software Installation, and Upgrade</b>	A separate software installation wizard has been added for UC500 upgrades under <b>Maintenance &gt; Software Upgrade &gt; UC500</b> . The wizard simplifies the software installation process and provides improved localization support. See <a href="#">Software Upgrades, page 500</a> .
<b>Switch Between Primary and Alternate Phone/ VM Languages</b>	Region settings have been simplified. You can now switch between the primary and secondary languages installed on the UC500 without having to re-install CUE. See <a href="#">Region Settings for Telephony, page 277</a> and <a href="#">How to Localize the UC500 (Non-US/English Locales), page 519</a> .
<b>Upload and Download files to UC500 Flash</b>	The File Management window now provides options for uploading and downloading files to the UC500 flash. See <a href="#">File Management, page 520</a> .
<b>Enable or Disable Network Polling</b>	The General tab in the Preferences window now provides an option for enabling or disabling network polling. By default, this network polling is disabled. See <a href="#">General, page 52</a> .

Feature	Description.
<b>User Interface Changes and Enhancements</b>	
<b>Telephony Configuration Menu Changes</b>	<p>Menus under <b>Configure &gt; Telephony</b> have been reorganized and renamed. See <a href="#">Users and Phones, page 303</a>. These changes include the following items:</p> <ul style="list-style-type: none"> <li>▪ The Voice window has been renamed Users and Phones and is now located under <b>Configure &gt; Telephony &gt; Users and Extensions</b>. The System and Network tabs associated settings were removed from the Voice window. Voice system settings are now configured on the System Settings window under <b>Configure &gt; Telephony &gt; System</b>.</li> <li>▪ The Region window is now located under <b>Configure &gt; Telephony &gt; System</b>.</li> <li>▪ The Single Number Reach window is now located under <b>Configure &gt; Telephony &gt; Users and Extensions</b>.</li> <li>▪ The System Speed Dial window is now located under <b>Configure &gt; Telephony &gt; Users and Extensions</b>. Speed dials for user phones are now configured from the Users and Phones window.</li> <li>▪ The Voicemail window is now located under <b>Configure &gt; Telephony &gt; Users and Extensions</b>.</li> <li>▪ The Auto Attendant, Schedules, Basic ACD, Night Service, and Live Record windows are now located under <b>Configure &gt; Telephony &gt; Call Handling</b>.</li> <li>▪ The Analog Port Settings window has been renamed FXS Ports and is now located under <b>Configure &gt; Telephony &gt; Ports and Trunks</b>.</li> <li>▪ The Multisite Manager and Maximum Calls windows are now located under <b>Configure &gt; Telephony &gt; Site Management</b>.</li> </ul>

**Release 2.2(6)**

CCA 2.2(6) is a maintenance release that resolves known issues found in CCA 2.2(5) and provides support for the UC500 Software Pack version 8.0.5, which includes the Cisco Unity Express (CUE) voicemail software version 8.0.3.

For more information, see the *Release Notes for Cisco Configuration Assistant Version 2.2(6)*, available on Cisco.com.

### Release 2.2(5)

Release 2.2(5) of CCA adds support for these devices and contains the following feature enhancements and user interface changes.

See the *Release Notes for Cisco Configuration Assistant Release 2.0 and Later* for a list of known issues that were resolved in this release.

Feature	Description.
<b>UC500 Software Pack 8.0.4 support</b>	CCA 2.2(5) supports the UC500 8.0.4 software pack. For more information and software pack component versions, see the <i>Release Notes for Cisco Configuration Assistant Release 2.0 and Later</i> .
<b>Windows 7 Support (64-bit and 32-bit versions)</b>	CCA can now be used on PCs running the Microsoft Windows operating system. Both 64-bit and 32-bit versions are supported. For important limitations and caveats that apply to CCA and Windows 7, see the <i>Release Notes for Cisco Configuration Assistant Release 2.0 and Later</i> .  <b>NOTE</b> Windows 7 User Account Control (UAC) must be disabled in order for CCA drag-and-drop upgrades and file operations to work.
<b>CCA Version Compatibility Checking</b>	When you launch CCA, the CCA Version Conflict dialog appears if the version of CCA you are using is older than the version of CCA that was previously used to configure the system. You can either close the dialog or choose to upgrade to a newer version of CCA. See <a href="#">CCA Version Compatibility Checking, page 20</a> .
<b>New Devices Supported</b>	IP Phones. CCA 2.2(5) adds support for these Cisco Small Business IP Phone models: <ul style="list-style-type: none"><li>▪ Cisco SPA Model 525G2</li><li>▪ Cisco SPA300 Series, all models</li></ul> Drag-and-drop phone load upgrades are supported for these new phones.

Feature	Description.
<b>Dialable Intercom</b>	<p>You can now configure dialable intercoms using CCA. These are configured on the User Extensions tab in the Voice window (<b>Configure &gt; Telephony &gt; Users and Extensions &gt; Users and Phones</b>).</p> <p>For more information, see <a href="#">Dialable Intercom, page 339</a>.</p>
<b>Whisper Intercoms</b>	<p>You can now configure Whisper Intercoms using CCA. These are configured on the User Extensions tab in the Voice window (<b>Configure &gt; Telephony &gt; Users and Extensions &gt; Users and Phones</b>).</p> <p>For more information, see <a href="#">Whisper Intercom, page 341</a>. Whisper Intercom is available only phone phones that support octal lines.</p>
<b>Conference Barge, Privacy, and Shared Octo-Line Extensions</b>	<p>You can now configure Conference Barge with Privacy using CCA. cBarge and Privacy require shared octo-line extensions to be configured.</p> <p>cBarge and Privacy are configured in the Conference Barge window (<b>Configure &gt; Telephony &gt; Voice Features &gt; Conference Barge</b>). Shared octo-line extensions are configured on the User Extensions tab in the Voice window (<b>Configure &gt; Telephony &gt; Users and Extensions &gt; Users and Phones</b>).</p> <p>For more information, see <a href="#">Conference Barge, page 385</a>.</p>
<b>Enable or Disable Conference Join and Leave Tones</b>	<p>You can now enable or disable tones played when callers join or exit a multi-party conference. To access these settings, choose <b>Configure &gt; Telephony &gt; Voice Features &gt; Conference</b>. Multi-party conferencing must be enabled.</p>
<b>Combined Paging Groups</b>	<p>CCA now supports combined paging groups. This feature allows paging groups to be members of other paging groups. To access paging group configuration, choose <b>Configure &gt; Telephony &gt; Phone Groups &gt; Paging Groups</b> from the feature bar.</p> <p>For more information, see <a href="#">Paging Groups, page 372</a>.</p>

Feature	Description.
<b>Overlay Extension on CO Line</b>	<p>You can now configure an Overlay extension on a CO (Central Office) line using CCA.</p> <p>For more information, see <a href="#">Overlay Extension, page 337</a>.</p>
<b>CUE Connectivity Diagnostics</b>	<p>From the CUE Connectivity Diagnostics window (<b>Troubleshoot &gt; CUE Diagnostics &gt; CUE Connectivity Diagnostics</b>), you can check connectivity with the CUE module on the UC500, generate logs, and perform recovery tasks to place the module into a known state.</p> <p>For more information, see <a href="#">CUE Connectivity Diagnostics, page 573</a>.</p>
<b>PCM Capture</b>	<p>From the PCM Capture window (<b>Troubleshoot &gt; Telephony Diagnostics &gt; PCM Capture</b>), you can perform a PCM capture to troubleshoot audio issues such as poor voice quality, one-way audio, or no audio.</p> <p>For more information, see <a href="#">PCM Capture, page 570</a>.</p>
<b>SIP Trunk Registration Diagnostics</b>	<p>The SIP Trunk Registration window (<b>Troubleshoot &gt; Telephony Diagnostics &gt; SIP Trunk Registration</b>) displays SIP registration information and provides diagnostic tools for troubleshooting SIP trunk registration problems.</p> <p>For more information, see <a href="#">SIP Trunk Registration, page 564</a>.</p>
<b>New Default AA Script</b>	<p>The <code>aa_sbcs_v03.aef</code> script is now the default Auto Attendant script. This version of the AA script provides an option for transferring calls to a designated phone number if the caller does not choose an action after the main greeting is played three times.</p> <p>For more information, see <a href="#">Auto Attendant Configuration, page 397</a>.</p>

Feature	Description.
<b>Miscellaneous Telephony Feature Enhancements</b>	<p>You can now enable or disable blocking of restricted calls and set calling permissions for common area phone/Fax devices. These settings are configured on the Analog Extensions tab in the Voice window (<b>Configure &gt; Telephony &gt; Users and Extensions &gt; Users and Phones</b>).</p> <p>A <b>Use as Teleworker Phone</b> option has been added to the User Extensions tab. When this option is checked, Media Termination Point (MTP) is configured on the selected phone. See <a href="#">User Extensions, page 304</a>.</p> <p>An <b>Allow video calls</b> option has been added to the User Extensions tab in the Voice window for phones that support point-to-point video. When this option is checked, Cisco Unified Voice Advantage (CUVA) is enabled on the selected phone. See <a href="#">User Extensions, page 304</a>.</p> <p>You can now <b>edit the description that appears in the upper right corner of the display on IP phones</b>. For example, you can edit this setting to show the full DID (Direct Inward Dial) number of the phone. In prior releases, CCA always displayed the First and Last Name of the phone user in this area. This setting is configured on the User Extensions tab in the Voice window. See <a href="#">User Extensions, page 304</a>.</p> <p>CCA now provides the ability to <b>disable configuration of STCAPP feature-access codes</b> on SCCP-controlled analog phones. We recommend that you disable STCAPP feature access codes to avoid conflicts with feature access codes that are configured using the fac commands under telephony-service. To access this setting, choose <b>Troubleshoot &gt; Telephony Diagnostics &gt; SCCP Analog Phones</b>. Disabling STCAPP feature access codes does not affect feature access codes configured using the fac commands under telephony-service, which are always enabled. See <a href="#">SCCP Analog Phones, page 571</a>.</p>



Feature	Description.
<b>HLog softkey support for regular and Basic ACD hunt groups</b>	When a BACD hunt group, regular hunt group, or call blast group is configured, the HLog softkey is added to group member phones. Agents and hunt group members can now log in or out of a hunt group using the <b>HLog</b> softkey. The <b>HLog</b> softkey is displayed on hunt group member phones when an incoming call rings the member phone. Users can also access this softkey from the main phone screen by pressing the <b>more</b> softkey. The <b>HLog</b> softkey replaces the use of DnD (Do Not Disturb). DnD is less flexible, since it makes the subscriber generally unavailable for all calls, not just hunt group calls.



## Getting Started with the Configuration

Read the topics in this section to learn about how to use Cisco Configuration Assistant (CCA) to connect to a customer site or standalone device and get started with the configuration. These topics are covered:

- **Creating and Managing Customer Sites**
- **Connecting to a Site or Standalone Device**
- **Using CCA Setup Wizards**
  - **Which Wizard Should I Use and When?**
  - **Telephony Setup Wizard**
  - **Security Setup Wizard**
  - **Wireless Setup Wizard**
  - **Device Setup Wizard**
  - **SR520-T1 Configuration Utility**
  - **Phone VPN Setup Wizard**
  - **Video Monitor Setup Wizard**
- **Backing Up and Restoring Device Configuration**
- **Using CCA with Cisco Small Business Office Manager, page 114**
- **Resources for Planning and Implementing Your SBCS Solution**
- **Cisco SBCS Features Supported Within CCA**

## Creating and Managing Customer Sites

Read this section to learn about how to create and manage customer sites using CCA:

- [About Customer Sites](#)
- [Customer Site Planning](#)
- [Creating a New Customer Site](#)

### About Customer Sites

Create a customer site to manage multiple Cisco Smart Business Communications System (SBCS) devices in the same logical group, regardless of their physical locations and the software installed on the devices. You can create, modify, delete, and manage multiple customer sites.

The benefit of creating a customer site is that you can manage and monitor multiple devices such as a UC500 and SR500 in a single session without having to reconnect to each device separately. Using a customer site allows CCA to implement solution-level features, such as synchronizing VLANs across multiple platforms and multisite deployments.

A customer site can contain up to 25 connected network devices. Each device must have an assigned IP address. Cisco Configuration Assistant uses the automatic discovery capability of Cisco Discovery Protocol (CDP) and the Bonjour protocol to find eligible network devices and to add them to a site. If devices do not have CDP enabled, you can still create a site and manually add the devices.

With CCA, you can communicate securely with every member in a customer site. If a site member fails, you can continue to manage the other members.

Most types of network devices—routers, switches, wireless LAN controllers—can belong to a customer site. For a specific list of eligible devices, see the *Release Notes for Cisco Configuration Assistant*.

The following basic networking tasks are supported for customer site members, including routers and access points:

- Managing user access
- Upgrading software
- Saving a running configuration

- Backing up and restoring a configuration
- Managing the system time
- Getting system message notifications
- Changing the HTTP port number
- Getting an inventory report

### Customer Site Planning

This section describes the guidelines, requirements, and caveats that you should understand before you create a customer site.

#### Member and Candidate Characteristics

Members are network devices that belong to a customer site. *Candidates* are network devices that are not yet part of a customer site.

To join a customer site, a candidate device must

- Be supported by CCA
- Have an IP address that is reachable from the PC running CCA
- Have HTTP or HTTPS enabled on the default ports

Access to these ports must be open if the device is behind a firewall.

#### Customer Site Device Limits

The combined number of these device types cannot exceed 25:

- UC500 Series platforms (UC520, UC540, and UC560)
- Cisco Small Business Pro ESW500 Series switches (all models and SKUs)
- Cisco AP541N Wireless access points
- Catalyst Express CE520 switches
- Cisco 800 Series routers
- Cisco 870 Series router
- Cisco SR500 Series Secure Routers
- Cisco SA500 Series Security Appliances
- Cisco 526 Wireless Express Controllers

- Cisco AP521 Wireless Express autonomous access points. These are fully featured standalone access points that do not require a Cisco 526 Mobility Controller.

There is no limit on the number of IP phones or lightweight access points—access points managed by a WLAN controller—in a customer site. There is no limit on the number of customer sites that CCA can manage.

In addition to the overall limit of 25 devices, there are these device-type limits:

- Catalyst Express CE520 and Cisco Small Business Pro ESW500 Series switches—no more than 15.
- Cisco 800 Series routers plus Unified Communications 500 Series platforms—no more than five (5).
- Cisco 526 Wireless Express Controllers—no more than two (2).
- Cisco AP541N wireless access points and Cisco AP521 autonomous access points plus built-in HWIC access points—no more than ten (10).

If the overall limit or a device-type limit is exceeded, you cannot manage the customer site. You must remove devices until the limit is no longer exceeded.

### Automatic Device Discovery

Beginning with the IP address for a starting device and the port numbers for HTTPS and HTTP, CCA uses Cisco Discovery Protocol (CDP) to compile a list of customer site candidates that are within four CDP hops of the starting device. Cisco Configuration Assistant can discover candidate and member devices across multiple networks and VLANs if they have valid IP addresses. See the **“Member and Candidate Characteristics” section on page 77** for a list of requirements that network devices must meet to be discovered.

**IMPORTANT** Do not disable CDP on candidates, members, or any network devices that you might want CCA to discover.

You can edit the list of discovered devices to fit your needs and to add them to the customer site. If CCA does not discover a network device, you can manually add the device.

For instructions on adding discovered devices to a customer site or manually adding devices to a customer site, see the **“Adding a Device to an Existing Customer Site” section on page 84**.

### Customer Site Names

When you create a customer site, CCA requires that you assign a name to it. The name can contain up to 64 alphanumeric characters and is not case sensitive.

### Hostnames

You can edit the default hostname for a customer site member. This is useful if you are configuring a multisite deployment or if there are multiple devices of the same type, for example, AP54 1N access points or switches. To edit the hostname of a managed device, go to **Configure > Device Properties > Hostname**.

### Passwords

When connecting to a customer site, CCA prompts you for each unique password that has already been assigned for members of the site. Cisco Configuration Assistant attempts to use these passwords to connect to other devices. You are prompted for a password only if the previously entered password does not work for a device.

**IMPORTANT** For Cisco IOS devices, the enable password for the device must be the same as the password used to log in to the device using CCA.

For example, if a customer site has ten members, and five members share one password and the other five share a different password, CCA prompts you twice, once for each password. Cisco Configuration Assistant does not save the passwords to your PC, so it prompts you for the passwords each time that you attempt to connect to a site.

### Communication Protocols

Cisco Configuration Assistant uses HTTPS, HTTP, Telnet, and SSH to communicate with devices. It tries to use HTTPS when discover neighboring devices and when devices are manually added to a customer site. If HTTPS fails, it tries HTTP.

The HTTPS port is fixed at 443; the HTTP port defaults to 80. You can specify a different HTTP port when you create a customer site. Afterward, you use the HTTP Port window to change the HTTP port. The port settings for both HTTPS and HTTP must be the same for all the members of a customer site.

### Customer Site Information

Cisco Configuration Assistant saves all individual device information, such as the IP address, the hostname, and the communication protocol, to your local PC. When CCA connects to a customer site, it uses the locally saved data to rediscover the member devices.

If you try to use a different PC to manage an existing customer site, none of the member device information is available. You need to create the customer site again and add the same member devices.

## Creating a New Customer Site

The Create New Customer Site window appears when you click **Add New Site** from the Customer Sites tab in the Customer Sites window or the Connect window.

If you are new to CCA or are creating a customer site for the first time, see [Creating and Managing Customer Sites, page 76](#) to learn more about the purpose and benefits of creating customer sites to manage devices using CCA.

Use this window to create a new customer site and discover devices that you can add to a customer site.

### Procedures

To create a new customer site, follow these steps.

---

**STEP 1** In the **Customer Site Information** section, enter a site name and description for the customer site.

The site name can be up to 64 characters long. You can use the characters A-Z, a-z, 0-9, - (hyphen), and \_ (underscore).

In the optional **Site Description** field, enter your company name, your organization name, or any other identifying text. The text appears as part of the recommended SSID (Service Set Identifier) when you create an SSID for your network.

**STEP 2** *Optional.* Click **Connection Options** if you want to

- Enter an HTTP port number (because the devices in the customer site do not use the default port of 80).
- Specify the access mode for discovering devices and connecting to the customer site for the first time. The default is **Read-only** if you are already connected to site whose access mode is **Read-only**; otherwise, it is **Read/Write**.



See [Connection Options, page 82](#).

- STEP 3** In the **Add Devices to Site** section, choose either **Specify a Device IP Address** or **Discover Devices**.
- To discover and add a single, standalone device to the site, choose **Specify a Device IP Address**, then enter the IP address of the device that you want CCA to discover.
  - To discover and add multiple devices at the site, choose **Discover Devices**. This table lists the options displayed in the **Discover Devices** menu, explains additional settings, and describes what CCA discovers and displays in the **Devices** table.

Option	What to Enter	What CCA Displays
<b>Discover Devices &gt; Using a Starting IP Address</b>	The IP address of a device with neighbors that you want to add to your site	Information about the device that you identified and about the neighbors that Cisco Discovery Protocol discovered by using a hop count of 4
<b>Discover Devices &gt; On a Subnet</b>	An IP address and a subnet mask that identify a subnet whose devices you want to add to your site	Information about the devices that it discovers on the subnet
<b>Discover Devices &gt; Within a Range of IP Addresses</b>	The start and end IP addresses whose range delimits the devices that you want to add to your site	Information about the devices that it discovers in the IP address range

**STEP 4** Click **Start**.

**STEP 5** When the discovery begins, the **Start** button becomes a **Stop** button. Click it any time that you want to interrupt the discovery process.

See [Automatic Device Discovery, page 78](#) for more information about the device discovery process.

**STEP 6** Enter login credentials for each device when prompted. You may also be prompted to accept security certificates for some devices.

**IMPORTANT** For Cisco IOS devices, the enable password for the device must be the same as the password used to log in to the device using CCA.

For more information, see [Passwords, page 79](#).

**NOTE** After three failed authentication attempts, the device icon is displayed in Red in the Topology view with the message “Unreachable: Authorization Failed.” To retry the connection, choose **System > Connect**. You are prompted to close the session and restart CCA.

**STEP 7** If CCA does not discover a device that you want in your customer site, try Step 3 again with a different **Discover** option.

**STEP 8** Find the rows in the Devices table for the devices that you *do not* want to add to the customer site, and uncheck them.

Up to 25 devices can be selected for a customer site. There are also limits on the number of certain device types that can be in a customer site. See [Customer Site Device Limits, page 77](#).

IP phones do not need to be explicitly added to a customer site.

**STEP 9** Click **OK** to add the selected devices to the customer site.

The new customer site is listed on the Customer Sites tab.

---

## Connection Options

This window appears when you click **Connection Options** in the Create New Customer Site window or the Modify Customer Site window.

- When you create a customer site and discover devices using a starting IP address, subnet, or range of IP addresses, CCA first uses HTTPS protocol to connect. If connection via HTTPS fails, CCA retries the connection using HTTP.
- When you use the Hostname/IP Address option to connect to a single device, CCA connects to the device using the protocol selected in the Advanced Options tab. The default is HTTPS.
- On subsequent connections to a customer site or standalone device, CCA uses the same protocol that was used during device discovery.

You can modify the **HTTP Port** field only if you are creating a customer site. The field must contain the number of the HTTP port that CCA will use to communicate with devices in the community.

If you enter an HTTP port number other than 80, the default, add and configure the port before you add any devices to the site. To change the port number afterward, use the HTTP Port window.

The port number used for HTTPS connections cannot be changed; it must be 443.

You can select an access mode and a privilege level only if you are creating a customer site. Your selection is used when discovering devices and connecting to the site for the first time.

Click **OK** when you are finished with this window.

### Modify a Customer Site

This window appears when you select a customer site and click **Modify** on the Customer Sites tab in the Connect window or the customer sites window.

From the Modify a Customer Site window, you can add or remove devices to or from a customer site. You can also

- Click **Advanced** to enter a new HTTP port number if the HTTP port for the devices in the customer site changes.
- Enter or modify your company name, your organization name, or other identifying text in the **Site Description** field. The text appears as part of the recommended SSID (service set identifier) when you create an SSID for your network.

### Procedures

To add or remove devices to a customer site, follow these steps.

- 
- STEP 1** From the **Discover** list, choose an option. Then fill in the fields below the list, and click **Start**. See [Creating a New Customer Site, page 80](#) for information about the options for discovering and adding devices to a site.
- STEP 2** When the discovery begins, the **Start** button becomes a **Stop** button. Click it any time that you want to interrupt the discovery process.
- STEP 3** If CCA does not discover a device that you want in your customer site, try Step 1 again with a different **Discover** option.

- 
- STEP 4** Find the rows in the Devices table for added devices that you *do not* want in the customer site, and uncheck them. Up to 25 devices can be in a customer site. There are also limits on the number of certain device types that can be in a customer site. See [Customer Site Device Limits, page 77](#) for more information.
  - STEP 5** To remove devices that are already in the customer site, uncheck the entries for them in the Devices table.
  - STEP 6** Click **OK** to save your changes and close the window.
  - STEP 7** Choose **Home > Topology View** to open the Topology view. Icons of the newly discovered devices are displayed in the Topology view.
  - STEP 8** To add a new device to an existing customer site, right-click on the icon in the Topology view and choose **Add to Site** from the pop-up menu.
- 

## Adding a Device to an Existing Customer Site

You can also add a device to an existing customer site. To do this, right-click a candidate icon in the Topology view, and select **Add to Site**. You are prompted to enter the administrator username and password to authenticate.

## Viewing and Listing Devices in a Customer Site

Follow these steps to view and list devices in a customer site and verify that the site contains the expected devices:

- 
- STEP 1** Choose **Home > Topology** to display the Topology view.
  - STEP 2** Choose **Monitor > Inventory** to display an inventory of the devices in the customer site.  
  
This summary includes device model numbers, serial numbers, software versions, IP information, and location.
  - STEP 3** Choose **Home > Front Panel** to display the Front Panel view.
  - STEP 4** Choose **Home > Dashboard** to display the system dashboard view.
-

### Managing Customer Sites

To manage customer sites, choose **Home** > **Customer Sites** from the feature bar.

From the Customer Sites window you can see a list of existing customer sites, create customer sites, modify customer sites, and delete customer sites.

#### Procedures

- To create a customer site, click **Add a New Site** to open the Create New Customer Site window. See [Creating a New Customer Site, page 80](#).
- To modify a customer site, select the customer site from the list and click **Modify Site** to open the Modify Customer Site window. See [Modify a Customer Site, page 83](#).
- To delete a customer site, select the customer site from the list and click **Delete Site**.

When you are done with this window, click **OK**.

## Connecting to a Site or Standalone Device

When you launch CCA, two windows open: the Cisco Configuration Assistant main window, which contains the user interface, and the Connect window.

You can also open the Connect window by choosing **System** > **Connect** from the menu bar.

Cisco Configuration Assistant starts in disconnected mode; that is, it is not connected to a customer site or a standalone device. In this mode, you see the menu bar in the CCA window but only a small number of items in the feature bar. The feature bar is created and populated with device features only when CCA is connected.

The following sections describe how to use each of the tabs in the Connect window:

- [Customer Sites Tab, page 86](#)
- [Hostname/IP Address Tab, page 88](#)
- [Advanced Options Tab, page 88](#)

### Customer Sites Tab

To manage and configure multiple devices on your network in a single session, create a customer site.

**TIP** If you are new to CCA or are creating a customer site for the first time, see [Creating and Managing Customer Sites, page 76](#) to learn more about the purpose and benefits of creating customer sites to manage devices using CCA.

From the Customer Sites tab, you can:

- Create a new customer site and connect to it
- Connect to an existing customer site by selecting it from a list.
- Modify or delete an existing customer site.

To create and connect to a new customer site, follow these steps.

- 
- STEP 1** Select the Customer Sites tab in the Connect window and click Add a New Site. The Create a New Customer site dialog appears.
- STEP 2** Complete the fields in the Create a New Customer Site dialog, discover devices, and add devices to the site as described in the section [Creating a New Customer Site, page 80](#).
- STEP 3** Once you have successfully created the customer site, it is displayed in the list of sites on the Customer Sites tab in the Connect window.
- STEP 4** Click **Connect**.

When you connect to a customer site, CCA displays an Authentication: Device dialog that prompts you for each unique password that has been assigned to members of that site.

- STEP 5** Enter login credentials for each device when prompted. You may also be prompted to accept security certificates for some devices.

**IMPORTANT** For Cisco IOS devices, the enable password for the device must be the same as the password used to log in to the device using CCA.

For more information, see [Passwords, page 79](#).

**NOTE** After three failed authentication attempts, the device icon is displayed in Red in the Topology view with the message “Unreachable: Authorization Failed.” To retry the connection, choose **System > Connect**. You are prompted to close the session and restart CCA.

When you have successfully authenticated, a CCA session is established. Only one session at a time can run on a PC.

When you are connected to the customer site, the status bar at the bottom of the window displays the message “**Discovering topology**” while CCA discovers devices and builds the Topology view. See [Topology View, page 32](#).

After the network topology information has been loaded, any voice configuration data on the system is read in. The status bar at the bottom of the page displays the message “**Loading voice-related data.**”

Wait until voice configuration data is finished loading before you can open any Voice or Telephony feature-related windows.

Devices that are part of the site are listed in the left frame of the Topology view (switches, access points, and so on). IP phones and devices that are not part of the customer site are listed under Neighbors in the left frame. Although IP phones are listed under Neighbors, they are configured through CCA.

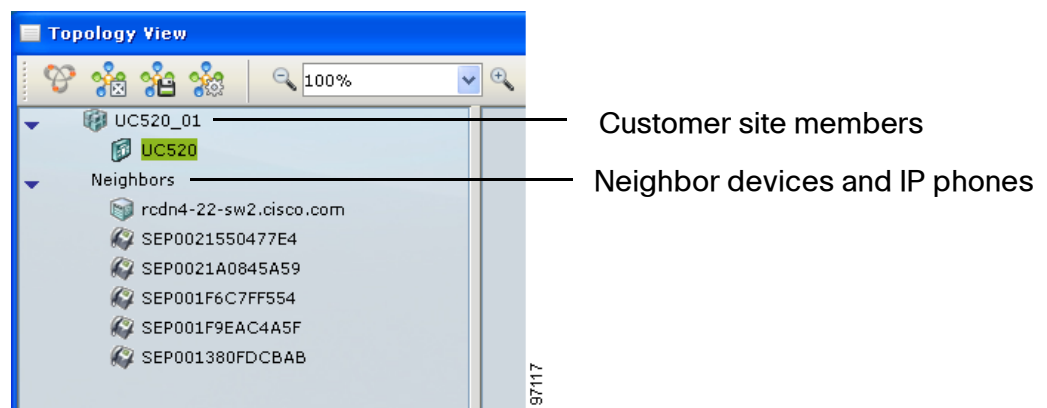

To end a session, close the CCA main window, or choose **System > Exit**. You will be prompted to save any configuration changes made during that session to a single device or to all devices.

To modify settings for an existing site, select a customer site from the list and click **Modify**. See [Modify a Customer Site, page 83](#).

To delete a customer site, select the customer site from the list and click **Delete**.

---

### Hostname/IP Address Tab

Use the Hostname/IP address tab when you want to connect to and manage a single, standalone device by specifying its hostname or IP address.

To connect to a single device, follow these steps.

- 
- STEP 1** Click the **Hostname/IP Address** tab, enter or select a hostname or IP address to connect to the device
  - STEP 2** Click **Connect**.
  - STEP 3** Enter the administrator username and password for authentication.

**IMPORTANT** For Cisco IOS devices, the enable password for the device must be the same as the password used to log in to the device using CCA.

When you have successfully authenticated, a CCA session is established. Only one session at a time can run on a PC.

**NOTE** After three failed authentication attempts, the device icon is displayed in Red in the Topology view with the message “Unreachable: Authorization Failed.” To retry the connection, choose **System > Connect**. You are prompted to close the session and restart CCA.

---

### Advanced Options Tab

On the **Advanced Options** tab, you can choose whether to grant **Read/Write** permission for this connection.

When you choose Read/Write, you have permission to configure networking features with CCA. Otherwise, select Read Only and choose an access level, from 1 to 15.

The default access mode is Read/Write.



## Using CCA Setup Wizards

In addition to the expert mode configuration GUI, CCA provides several setup wizards to assist you in configuring Cisco SBCS solutions, features, and devices.

To access CCA setup wizards, choose **Home** on the CCA feature bar.

Some wizards are only available if the required devices are members of the customer site to which you are connected. For example, if the customer site does not have wireless capabilities, the Wireless Setup Wizard option is not displayed.

See the following sections:

- [Which Wizard Should I Use and When?, page 89](#)
- [Telephony Setup Wizard, page 92](#)
- [Security Setup Wizard, page 95](#)
- [Wireless Setup Wizard, page 98](#)
- [Device Setup Wizard, page 100](#)
- [SR520-T1 Configuration Utility, page 101](#)
- [Phone VPN Setup Wizard, page 101](#)
- [Video Monitor Setup Wizard, page 104](#)

### Which Wizard Should I Use and When?

Each of the CCA setup wizards is designed to automate configuration and maintenance for specific devices, features, and types of deployments. Available setup wizards are summarized in the following table.

Wizard	What this wizard does	When to use this wizard	To learn more
<b>Telephony Setup Wizard</b>	<p>For a Cisco SBCS/UC500 system, the Telephony Setup wizard configures basic WAN and LAN settings, system locale, telephony system settings, voice trunks (except SIP trunks), voice ports, Auto Attendant, schedules, phone users and extensions, inbound call routing, and hunt groups.</p> <p>The wizard supports all UC500 platforms. If the UC500 is behind an SR500 Series secure router or SA500 security appliance, the wizard automatically adjusts static routes and ACLs and removes the firewall on the UC500.</p>	<p>Use this wizard for first-time setup only. This wizard requires a UC500 with factory default configuration.</p> <p>Run the Telephony Setup Wizard <i>before</i> running other CCA setup wizards.</p> <p>If an SR520-T1 secure router provides the WAN connection, you must also run the SR520-T1 Configuration Utility. Run the SR520-T1 Configuration Utility <i>before</i> running the Telephony Setup Wizard. See <a href="#">SR520-T1 Configuration Utility, page 101</a>.</p> <p>For SR520 ADSL/Ethernet secure routers and SA500 Series Secure routers, configure the WAN connection before running the Telephony Setup Wizard.</p>	<a href="#">Telephony Setup Wizard, page 92</a>
<b>Security Setup Wizard</b>	<p>The Security Setup wizard is used for configuring data-only small business deployments with an SA500 Series Security Appliance as the WAN edge device, along with Cisco Small Business Pro switches and wireless access points.</p> <p>This wizard configures basic WAN, LAN, and wireless network setting on the SA500 Series Security Appliance. It also automates trunk configuration for attached Cisco Small Business Pro ESW500 Series or CE520 switches and synchronizes wireless profiles on SA500 integrated and external AP54 1N access points that are members of the same customer site.</p>	<p>Use this wizard for first-time setup of an SA500 data deployment.</p> <p>You can also re-run the wizard to update these settings for an existing deployment.</p> <p>This wizard also supports a <i>staging mode</i> that allows you to pre-configure settings without the SA500 and other devices physically connected to the network. In staging mode you can export and import the configuration to and from a local file before applying the final configuration.</p> <p>Run this wizard <i>before</i> configuring security features with the SA500 Configuration Utility.</p>	<a href="#">Security Setup Wizard, page 95</a>
<b>Device Setup Wizard</b>	<p>The Device Setup wizard provides instructions for connecting and configuring basic device settings such as hostname and IP address so that they can be managed by CCA.</p> <p>These devices are supported:</p> <ul style="list-style-type: none"> <li>Cisco Catalyst Express CE520 switches</li> <li>Cisco AP521 autonomous access points</li> <li>Cisco WLC526 wireless LAN controllers</li> <li>Cisco SR520 ADSL/Ethernet secure routers</li> </ul>	<p>Use this wizard for first-time setup of these devices from their factory default configuration.</p>	<a href="#">Device Setup Wizard, page 100</a>

Wizard	What this wizard does	When to use this wizard	To learn more
<b>Wireless Setup Wizard</b>	<p>The Wireless Setup Wizard configures and synchronizes wireless network and profile settings for voice-over-wireless deployments or data-only wireless deployments with multiple access points.</p> <p>The wizard supports UC500 integrated APs, AP521 autonomous access points, SPA525G and SPA525G2 IP phones operating in wireless-G mode, and AP541N APs.</p>	<p>Use this wizard for first-time setup and synchronization of wireless profiles for wireless voice and data deployments with SPA525G IP phones and supported APs.</p> <p>You can re-run the wizard to update wireless network and profile settings.</p>	<a href="#">Wireless Setup Wizard, page 98</a>
<b>Phone VPN Wizard</b>	<p>The Phone VPN Setup Wizard configures VPN client settings on Cisco SPA525G or SPA525G2 IP phones to be deployed for use at remote sites.</p> <p>The Phone VPN Setup wizard cannot be used in deployments where the UC500 is behind an SA500 Security Appliance.</p>	<p>Run this wizard at the main site to automate phone VPN client configuration for SPA525G IP phones that will be deployed at remote sites.</p> <p>You can re-run the wizard to update or remove existing VPN configuration from phones.</p> <p>It is recommended that you run the Telephony Setup wizard <i>before</i> running the Phone VPN wizard.</p>	<a href="#">Phone VPN Setup Wizard, page 101</a>
<b>Video Monitor Setup Wizard</b>	<p>The Video Monitor Setup wizard configures camera settings and associates Cisco PVC2300/WVC2300 Series Business Internet Video Cameras with SPA525G and SPA525G2 IP phones. This enables users to monitor video from these cameras using the built-in video monitor on the SPA525G and SPA525G2 IP phones.</p>	<p>This wizard can be used for first-time setup of the video monitoring feature on SPA525G phones and Cisco PVC2300/WVC2300 Series IP cameras.</p> <p>You can re-run the wizard to update an existing installation.</p> <p>Run the Telephony Setup Wizard <i>before</i> running the Video Monitor Setup wizard.</p>	<a href="#">Video Monitor Setup Wizard, page 104</a>
<b>Multisite Manager</b>	<p>Use the Multisite Manager to configure and manage Cisco SBCS multisite voice and data deployments.</p>	<p>Use the Multisite Manager for first-time configuration of a Cisco SBCS multisite deployment. Existing out-of-band multisite configurations are not recognized by CCA.</p> <p>You can also use the Multisite Manager to add, remove, or edit sites or to update settings for an existing deployment.</p> <p>It is recommended that you run the Telephony Setup wizard <i>before</i> running the Multisite Manager.</p>	<a href="#">Multisite Manager, page 443</a>

## Telephony Setup Wizard

To launch the Telephony Setup wizard, choose **Home > Telephony Setup Wizard** from the feature bar. If the UC500 at the customer site is in factory default configuration, this wizard is launched automatically.

The Telephony Setup Wizard walks you through the steps required to configure a basic telephony solution.

The wizard is intended for initial installations and for cases in which you want to reset the Cisco UC500 to factory defaults and completely replace the current configuration.

These settings are configured through the wizard:

- Basic network settings such as WAN connection type
- Phones, users, and primary extensions
- Hunt groups and blast groups
- Trunk settings (ISDN BRI, ISDN PRI, and analog trunks) and phone numbers
- Locale-specific dial plan
- Inbound call routing
- Business schedules
- Auto Attendant actions and prompts

When you launch the Telephony Setup Wizard, CCA detects the number of software licenses installed and the currently installed UC500 software pack and/or Cisco IOS software version.

The Telephony Setup Wizard also supports bulk import of user and phone data. For information about how to prepare the data for import, see [Importing Phone Data for Multiple Users \(Bulk User Import\), page 310](#).

Buttons for accessing the CCA expert mode Software Upgrade and License Management windows are provided to allow you to perform software and/or license upgrades before continuing with the wizard. Clicking these buttons closes the wizard.

### Before You Begin

Before running the Telephony Setup Wizard

- If the PC running CCA has more than one network interface (for example, a dual-NIC for wired and wireless network connection), make sure that only one is enabled.
- Disable any third-party firewall or TFTP services on the PC running CCA.
- Check the firewall and network security settings on your PC to make sure that TFTP traffic is allowed between the PC and the UC500.
- Ensure that the PC running CCA is directly connected to a LAN port on the UC500 and has obtained an IP address from the UC500 using DHCP.
- Make sure that the UC500 system is at factory default configuration.
- For non-US locales, download and install localization files in the appropriate location.
- Make sure that you have gathered all the information listed on the Welcome page of the wizard.
- If the UC500 will be behind an SA500 Series Security Appliance or SR500 Series Secure Router, connect the UC500 WAN to the SA500 or SR500 LAN before running the Telephony Setup Wizard.

### Using the Telephony Setup Wizard

To access this wizard from the feature bar, navigate to **Home > Telephony Setup Wizard**.

The configuration you set up via the wizard is not applied until the final page of the wizard. To go back to previously visited pages of the configuration:

- Use the **Back** button.
- Use the navigation panel on the left side of the page to go to specific pages within a configuration section.
- Use the Summary page links, then click **Resume** to return to the summary page.

If the changes you make affect other settings configured through the wizard, navigation menu items highlighted in Red indicate errors that must be corrected before continuing.

Once you click **Apply Configuration**, the settings chosen in the wizard are applied. If you exit the wizard before applying the configuration, all settings entered through the wizard are discarded.

After the initial configuration is established through the wizard and you have verified that basic networking and voice features are working properly, continue configuring additional network, security, and voice features through the main Cisco Configuration Assistant GUI.

### Next Steps

These telephony features are not configured through the Telephony Setup wizard:

- Calling permissions for individual phones (call permissions are unrestricted for phones added through the wizard)
- Call blocking for individual phones (call blocking is disabled for phones added through the wizard)
- Intercoms, shared lines, overlays, and octal lines
- Monitor mode and Watch mode lines
- SIP trunk interface
- Basic ACD (automatic call distribution)
- Multi-party conferencing (Ad Hoc/Meet-Me)
- Night service
- Custom outgoing dial plan numbers
- Trunk groups and priorities
- System speed dials
- Paging groups
- Call Pickup groups
- Call Park extensions
- Conferencing
- Extension Mobility

See the CCA online help or other sections in this guide for information about how to configure these features in expert mode using CCA.

## Security Setup Wizard

To launch the Security Setup Wizard, choose **Home > Security Setup Wizard** from the feature bar.

**NOTE** The Security Setup Wizard is intended for use in data-only deployments with SA500 Series Security Appliances, ESW500 Series switches, and AP541 access points. If you are deploying a UC500 telephony solution, run the Telephony Setup Wizard to set up the network.

The Security Setup Wizard can be used for first-time set-up or to edit existing configuration, as described in these sections:

- [Overview](#)
- [Staging the Configuration](#)
- [Downloading and Installing the Latest Firmware for SA500, ESW500, and AP541N Devices](#)
- [Using the Security Setup Wizard](#)
- [Next Steps](#)

### Overview

Cisco SA500 Series Security Appliances provide WAN connectivity, routing, firewall, security, remote access, and wireless access for small business networks.

The Security Setup Wizard guides you through the steps required to configure wireless network settings for a Cisco SA500 Series Security Appliance in a small business data-only network. The wizard also synchronizes wireless profile information for integrated SA500 wireless and AP541N access points that are members of the CCA customer site.

When you apply the configuration through the wizard, CCA automatically sets up 802.1q trunking and synchronizes wireless LAN (WLAN) data and guest profile settings for connected Cisco Small Business Pro devices such as ESW500 Series switches and AP541N access points.

### Staging the Configuration

If CCA detects that the customer site that you are connected to does not contain an SA500, the wizard automatically runs in staging mode.

In staging mode, you can pre-configure settings and save your progress at any point in the wizard by choosing **Export Configuration to File**. To resume configuration, re-run the wizard and choose **Import Configuration From File**.

Once the equipment is available and you are connected to the customer site, re-launch the wizard, import your previously saved configuration, make any needed changes, and apply the configuration.

### Downloading and Installing the Latest Firmware for SA500, ESW500, and AP541N Devices

If you are connected to a CCA customer site with an SA500, the current SA500 device firmware version is displayed. Version 1.1.21 or later of the SA500 firmware is required.

To obtain the latest firmware from Cisco.com, follow these links. A Cisco.com login is required.

- Software downloads for SA500 Security Appliances are available at [www.cisco.com/go/sa500software](http://www.cisco.com/go/sa500software).
- For ESW500 Series switches, a link to the software downloads is available at [www.cisco.com/go/esw500help](http://www.cisco.com/go/esw500help). Click the **Resources** tab and choose the Firmware link under **Firmware and Release Notes**.
- For AP541N access points, software downloads are available at [www.cisco.com/go/ap500software](http://www.cisco.com/go/ap500software).

When you have finished downloading the software, click the **Upgrade Software** button in the wizard or choose **Maintenance > Software Upgrade** from the feature bar in CCA to open the CCA Software Upgrade window.

Follow the instructions in the CCA online help to upgrade firmware for these devices. See [Software Upgrades, page 500](#).

### Using the Security Setup Wizard

To launch the wizard, choose **Home > Security Setup Wizard** from the feature bar.

Follow the onscreen instructions in the wizard to configure these settings:

- Administrator password (for security reasons, this must be changed from the default cisco password)



- Timezone, daylight savings time option, and NTP servers

You cannot directly set the system time on the SA500. Therefore, an NTP server is required. The default servers (0.us.pool.ntp.org and 1.us.pool.ntp.org) are scoped to the United States, rather than the global zone.

- WAN connection (DHCP, Static IP, or PPPoE)
- Data VLAN
- Static routes
- Wireless guest network
- Wireless SSID, VLAN ID, and profile information for data and guest networks.

When you apply the configuration, the wizard synchronizes these wireless profile settings with the integrated SA520W access point and all AP54 1N access points on the network. To be synchronized, these access points must be members of the CCA customer site to which you are connected.

Existing configuration is replaced with the new configuration.

WPA2 security with TKIP + CCMP encryption is automatically configured for the wireless security type.

You can re-run the wizard at any time to modify these settings.

### Next Steps

When you have completed the Security Setup Wizard, you can right-click on the SA500 icon in the Topology view and choose **Configuration Utility** to run the Web-based SA500 management software.

From the SA500 Configuration Utility you can configure security features for the customer site, such as firewall and DMZ, URL filtering, Intrusion Prevention System (IPS), port forwarding, and SSL VPN. These features are not configured through CCA.

Cisco ProtectLink Gateway is a hosted security service that blocks spam and filters URLs to prevent unwanted content from passing into your business network. Follow the instructions in the *Cisco SA500 Series Security Appliances Administration Guide* to obtain an Activation Code and enable ProtectLink services on the SA500. To learn more, visit [www.cisco.com/go/protectlink](http://www.cisco.com/go/protectlink).

For more information, see the *Cisco SA500 Series Security Appliances Administration Guide*, available on Cisco.com at the following URL:

[www.cisco.com/go/sa500](http://www.cisco.com/go/sa500)

Click the **Resources** tab and scroll to the **Technical Documentation** section to locate the administration guide and other relevant links.

## Wireless Setup Wizard

To launch the Wireless Setup wizard, choose **Home > Wireless Setup Wizard** from the feature bar. The Wireless Setup Wizard menu option is only available if the customer site to which you are connected has wireless capability.

- **Overview**
- **Before You Begin**
- **Using the Wireless Setup Wizard**

### Overview

Use the Wireless Setup Wizard to automate configuration of wireless settings for multiple access points or to configure Cisco SBCS voice-over-wireless solutions with Cisco SPA525G or SPA525G2 IP phones operating in wireless-G mode. Wireless network and profile settings are synchronized among access points and SPA525G and SPA525G2 phones that are members of the customer site. All UC500 models are supported.

These wireless devices are supported:

- Integrated UC500 access points
- Cisco Small Business Pro AP54 1N access points
- Cisco AP521 autonomous access points

**IMPORTANT** If clustering is enabled for AP54 1N access points that are part of a CCA customer site, do not run the Wireless Setup Wizard to configure these access points.

If you are using Cisco AP54 1N access points with SPA525G/SPA525G2 phones, follow the SBCS deployment guidelines described in the *Cisco SBCS 2.0 Voice Over Wireless Deployment Guide*. This guide is available on Cisco.com at the following URL:

[www.cisco.com/en/US/docs/voice\\_ip\\_comm/sbcs/deployment\\_guides/voice\\_over\\_wireless/sbcs\\_20\\_vowifi\\_deployment\\_guide.pdf](http://www.cisco.com/en/US/docs/voice_ip_comm/sbcs/deployment_guides/voice_over_wireless/sbcs_20_vowifi_deployment_guide.pdf)

Cisco Model 7921 and 7925 phones can be used with SBCS 2.0 voice over wireless solutions that use AP54 1N access points. However, the Wireless Setup Wizard does not automatically synchronize wireless profile settings for these phones.

If you are using older Cisco AP 521 autonomous access points with SPA525G/SPA525G2 IP phones, follow the reference designs and guidelines specified in the *Cisco SPA525G Wireless Deployment Guide for Cisco SBCS*. This guide is available on Cisco.com at the following URL:

[www.cisco.com/en/US/docs/voice\\_ip\\_comm/sbcs/deployment\\_guides/spa525g\\_phone/sbcs\\_spa525g\\_wireless\\_deployment\\_guide.pdf](http://www.cisco.com/en/US/docs/voice_ip_comm/sbcs/deployment_guides/spa525g_phone/sbcs_spa525g_wireless_deployment_guide.pdf)

### Before You Begin

Your system must meeting the following requirements:

- CCA version 2.2(2) or later is required for AP54 1N support via the Wireless Setup Wizard.
- SPA525G IP phones must be running firmware version 7.1.3 or later
- UC500 software pack 7.0 or later
- AP54 1N access points must be running firmware version 1.8.0 or later.
- SPA525G/SPA525G2 phones that will be connected wirelessly must have a Model PA100 external power supply.

Before running the Wireless Setup wizard, you must

- Gather the following information: SSIDs and passwords (pre-shared keys) that you want to use for the wireless data, voice, and guest networks.
- Connect any external access points (AP54 1Ns or AP52 1s) to the UC500.
- Connect any SPA525G/SPA525G2 phones directly to the LAN side of the UC500 for wireless profile synchronization.
- Create a CCA customer site for the UC500, phones, and access points.
- Connect to the customer site and verify that the external access points are members of the customer site.

### Using the Wireless Setup Wizard

To run the Wireless Setup Wizard, connect to the customer site you created and choose **Home > Wireless Setup Wizard** from the feature bar.

Follow the onscreen instruction to configure these settings:

- Enable wireless mode on the SPA525G/SPA525G2 phones.
- Configure SSIDs, passwords (pre-shared keys), for wireless data and voice networks.
- Choose whether or not to enable SSID broadcast.
- Enable the guest network, if needed, and configure the SSID, password (pre-shared key), and choose whether to enable SSID broadcast.

The following notes apply to VLAN IDs configured by the Wireless Setup Wizard:

- The voice network VLAN ID is set to 1 (the value reserved by CCA).
- The data network VLAN ID is set to 100 (the value reserved by CCA).
- The guest network VLAN ID is set to 25 (the value reserved by CCA).
  - If the cisco-guest SSID already exists on a device in the customer site and its VLAN ID is not set to 25, the existing cisco-guest SSID is deleted and re-created, and its VLAN ID is set to 25.
  - If the cisco-guest SSID already exists on a device in the customer site and its VLAN ID is already set to 25, its configuration is not modified.

The wizard automatically configures QoS settings on AP541N access points and WPA2-PSK encryption for wireless security. You do not need to specify these options.

You can re-run the wizard at any time to modify these settings. Each time you run the wizard, it overwrites existing values with the new settings.

## Device Setup Wizard

New devices or devices that have been reset to their factory defaults must be set up. Use the Device Setup Wizard to make these devices ready for CCA to manage. To start the wizard, choose **Home > Device Setup Wizard** on the feature bar. Follow the step-by-step onscreen instructions to set up the device.

**NOTE** The Cisco SR520-T1 secure router has its own setup utility, the SR520-T1 Configuration Utility. This setup utility is launched automatically if the SR520-T1 device is connected to a UC500 and is at factory default configuration. See [SR520-T1 Configuration Utility, page 101](#).

You can configure these devices using the Device Setup Wizard:

- Cisco SR520 ADSL/Ethernet secure routers
- Cisco CE520 switches
- Cisco AP521 autonomous access points
- Cisco WLC526 wireless LAN controller

The Cisco AP54 1N Dual-band Single-radio wireless access point cannot be configured through the Device Setup Wizard.

### SR520-T1 Configuration Utility

If your site includes an SR520-T1 Secure Router and the SR520-T1 is at factory default state, choose **Home > SR520-T1 Configuration Utility** to:

- Set up the T1 WAN connection
- Modify the default the LAN0 IP address during the initial setup (*optional*)
- View diagnostic information and execute ping tests to verify connectivity
- Upgrade SR520-T1 software

For important information about prerequisites and step-by-step procedures, see the *Cisco Small Business Pro SR520-T1 Secure Router Quick Start Guide* and the *UC500 and SR520-T1 Secure Router Setup* application note, available on Cisco.com.

Once you have configured the T1 connection, use CCA in expert mode to configure additional settings and features such as NAT, Firewall and DMZ, administrator accounts, DNS, hostname, NTP, SNMP, static routes, and licensed security features (IPS, SSL VPN, and URL filtering).

### Phone VPN Setup Wizard

**NOTE:** The Phone VPN Setup wizard cannot be used in deployments where the UC500 is behind an SA500 Security Appliance.

To launch the Phone VPN Setup Wizard, choose **Home > Phone VPN Setup Wizard** from the feature bar. The Phone VPN Setup Wizard menu item is only available if the customer site to which you are connected contains at least one SPA525G or SPA525G2 IP phone.

- **Overview**

- **Before You Begin**
- **Launching and Using the Phone VPN Setup Wizard**
- **Enabling the Phone VPN at the Remote Site**
- **Modifying Phone VPN Settings After the Initial Installation**

### Overview

Use the Phone VPN Setup Wizard to configure VPN client settings on Cisco SPA525G or SPA525G2 IP phones to be deployed for use at remote sites.

- **At the office** — Connect the IP phones to the UC500, configure user extensions using CCA, and run the wizard to configure VPN client settings on the phone and set up VPN user accounts on the server. Once configured, the phone can be unplugged and sent to the remote site.
- **At the remote site** — The remote user connects the phone to the network at the remote site and enables the VPN client on the phone. The phone initiates a connection to the UC500 over a secure VPN tunnel using the pre-configured settings. Once connected to the VPN, the phone appears just like any other phone at the main site, and calls between the main site and the remote site go over the VPN.

You can re-run the Phone VPN Setup wizard as needed to add, edit or remove phone VPN client settings on phones, for example, to re-deploy a phone at the main site, configure additional VPN-enabled phones, or change the user associated with the phone.

### Before You Begin

Before launching the Phone VPN Setup Wizard, your system must meet the following requirements:

- SSL VPN Server and Anyconnect client settings must be configured for the site. If SSL VPN is not configured, you are asked to configure it before continuing.

A static IP address for the WAN connection is required for SSL VPN server configuration. Also, you must enable Full Tunnel mode and install the SSL VPN Anyconnect client package for Microsoft Windows. Split Tunnel mode is not supported for phone VPN.

- All IP phones to be configured for VPN must have the latest phone firmware installed. Version 7.4.2 or later is required.

- The IP phones must be powered on and connected to the UC500 through a LAN port on the UC500 or through a switch or wireless AP that is connected to the UC500.
- When calculating the total number of simultaneous VPN connections required for a customer site, be sure to include the VPN connections that are used for IP phone VPNs.

The UC520 and UC540 platforms support a maximum of 10 simultaneous VPN connections. The UC560 platform supports a maximum of 20 simultaneous VPN connections.

- The IP phones must be registered to the UC500 and display an extension.
- Basic network and telephony settings must be configured for the customer site, using either the Telephony Setup Wizard or the CCA expert mode GUI.
- For ease-of-use, user extension settings such as phone user ID, password, and phone buttons should be configured before running the VPN Phone Setup wizard. This is recommended, but not required. User extension settings can still be edited after you run the Phone VPN Setup Wizard.

### Launching and Using the Phone VPN Setup Wizard

To launch the Phone VPN Setup Wizard, choose **Home > Phone VPN Setup Wizard**.

The wizard discovers SPA525G and SPA525G2 IP phones connected to the UC500 and displays the MAC address, extension, and phone user ID to help you identify the phones.

Follow the on-screen instructions in the wizard to select phones and enter a VPN username and password for the VPN account to associate with the phone.

As each phone is configured, the Status column updates to indicate success or failure. If the configuration fails for a phone, the wizard continues with the next phone in the list.

### Enabling the Phone VPN at the Remote Site

At the remote site, the phone user must follow these steps to set up their IP phone and connect it to the VPN.

---

**STEP 1** Connect the IP phone to power.

**STEP 2** Connect the phone to the network at the remote site (home or remote office).

**STEP 3** Wait for the phone to initialize and obtain an IP address from the network at the remote site.

The phone automatically connects to the VPN server.

If you do not want the phone to automatically connect to the VPN server, set the **Connect on Bootup** option on the SPA525G/SPA 525G2 IP phone to **OFF**. To access this setting, press the **settings** button on the phone and go to **Information and Settings > Network Configuration > VPN**.

For more information on the Cisco SPA525G/SPA525G2 IP phones, go to this URL:  
[www.cisco.com/go/500phones](http://www.cisco.com/go/500phones)

---

### Modifying Phone VPN Settings After the Initial Installation

You can re-run the Phone VPN wizard to configure VPN settings for additional supported IP phones, edit existing VPN settings, or remove VPN settings from the configuration for phones.

To remove existing VPN configuration from phones, re-run the Phone VPN Setup Wizard and deselect (uncheck) those phones in the list of available phones before applying the configuration.

## Video Monitor Setup Wizard

To access the Video Monitor Setup Wizard, choose **Home > Video Monitor Setup Wizard** from the feature bar.

The Video Monitor Setup Wizard menu item is only available if the customer site to which you are connected has at least one SPA525G or SPA525G2 IP phone and one Cisco PVC2300 or WVC2300 Business Internet Video Camera.

- **Overview**
- **Before You Begin**
- **Preparing IP Cameras and Phones for Video Monitoring**
- **Launching and Using the Phone VPN Setup Wizard**
- **Configuring PVC2300/WVC2300 Video Settings**
- **Viewing Video on SPA525G/SPA525G2 IP Phones**
- **Modifying Video Monitor Settings After the Initial Installation**



### Overview

The Video Monitor Setup wizard guides you through the steps required to configure camera settings and associate Cisco 2300 Series Business Internet Video Cameras with SPA525G/SPA525G2 IP phones. This enables users to monitor video from the cameras using the built-in camera viewer on the SPA525G/SPA525G2 IP phones.

Each SPA525G/SPA525G2 IP phone can receive video from up to four (4) Cisco 2300 Series Business Internet Video Cameras. Model PVC2300 (wired, PoE) and WVC2300 (wireless, non-PoE) cameras are supported.

The following limitations apply to video monitoring on SPA525G/SPA525G2 IP phones:

- While monitoring video from the SPA525G/SPA525G2 phone, the phone can still make and receive calls. However, inbound calls do not change the display focus, and the only visual indication will be a flashing light associated with the line being called. To answer inbound calls, simply press the line button.
- If you are viewing video on the phone, the video application stops when you make an outbound call and does not automatically resume.
- There is no audio integration between the IP phone and the cameras.
- You cannot simultaneously enable the VPN client and video monitoring on SPA525G/SPA525G2 phones.
- Door Access Control from the SPA525G/SPA525G2 phone using the GPIO ports on the back of the camera is not supported.

### Before You Begin

Before launching the Video Monitor Setup wizard, make sure that your system meets these requirements:

- Basic network and telephony settings are configured for the customer site, using either the Telephony Setup Wizard or the CCA expert mode GUI.
- Cisco SPA525G/SPA525G2 IP phones must be running phone firmware version 7.4.3 or later and must be members of the CCA customer site to which you are connected. See [Preparing IP Cameras and Phones for Video Monitoring, page 108](#).

- The Cisco 2300 Series Business Internet Video Cameras must be running camera firmware version 1.1.1.4 or later and must be members of the CCA customer site to which you are connected. The cameras must be assigned a static IP address.

If you are using WVC2300 (wireless, non-PoE) cameras, the default SSID (ciscosb) and wireless profile settings must be configured to match those on the access points and the UC500.

For information about where to download the latest camera firmware and how to upgrade camera firmware, see [Preparing IP Cameras and Phones for Video Monitoring, page 108](#).

- The PC running CCA must be connected to a CCA customer site that contains the UC500, SPA525G/SPA525G2 IP phones, and Cisco PVC2300/WVC2300 Series cameras.

### Launching and Using the Video Monitor Setup Wizard

**STEP 1** When all of the cameras are added to the customer site, choose **Home > Video Monitor Setup Wizard** to start the wizard.

**STEP 2** Follow the onscreen instructions in the wizard to configure camera settings and associate IP phones with the cameras.

- a. For each camera in the list, you can edit the camera name and location description, specify a username and password, and specify an extension to call.

The username and password configured through the wizard provides administrative access to the camera by CCA for creating accounts with Monitor privileges on the cameras that are used by the IP phones. The phone number specified in the **Extn to Call** field is the extension or phone number that is dialed when a phone user presses the **Call** softkey on their IP phone while viewing video from the camera.

- b. Associate SPA525G/SPA525G2 IP phones with IP cameras. Each IP phone can be associated with up to four (4) cameras.

**STEP 3** Review the settings and apply the configuration.

The video cameras and associated IP phones are restarted after the configuration is applied.

**IMPORTANT** Follow the instructions in the section [Configuring PVC2300/WVC2300 Video Settings, page 107](#) to configure video settings for the cameras that will be sending video to the phones.

---

### Configuring PVC2300/WVC2300 Video Settings

You must change the MJPEG video settings on the WVC2300/PVC2300 cameras to the format required for SPA525G integration.

For each camera, perform these steps to configure the video settings.

---

**STEP 1** From the Topology view in CCA, right-click on the camera icon and choose Configuration Utility.

**STEP 2** From the left navigation menu in the camera configuration utility, choose **Audio/Video > Video**.

**STEP 3** In the **MJPEG Settings** section, configure these settings:

**Resolution:** 320\*240

**Max Frame Rate:** 10 fps

**Video Quality Control:** Select **Fixed Quality** and set it to **Normal**.

**STEP 4** Save the configuration and exit the PVC2300/WVC2300 Configuration Utility.

**IMPORTANT** The MJPEG settings for the camera cannot be changed if the camera is integrated with the SPA525G/SPA525G2 phone. Changing these settings will prevent the video stream from being displayed on the phone.

---

### Viewing Video on SPA525G/SPA525G2 IP Phones

Once the phones and cameras have restarted, follow these steps to view video on the SPA525G IP phones.

---

**STEP 1** On the SPA525G/SPA525G2 IP phone, press the **settings** button.

**STEP 2** Use the up and down arrow keys on the phone to navigate to Information and **Settings > Video Monitoring** and click the center select button.

- STEP 3** Choose a camera from the list and click the **Monitor** softkey.
- STEP 4** When the phone is connected to the camera and displays video, press the **Call** softkey to dial the phone extension you configured through the wizard.

---

### Modifying Video Monitor Settings After the Initial Installation

To add or remove phones and cameras or change settings, you can re-run the wizard.

If wireless IP cameras are used, they must be configured with the same SSID as the data network on the UC500 and access points. Wireless SSID settings can be edited using the PVC2300/WVC2300 Configuration Utility or by using CCA in expert mode. Choose **Configure > Wireless > WLANs (SSIDs)** from the feature bar to access these settings in CCA.

You can also view or modify camera device properties such as users and passwords using CCA.

### Preparing IP Cameras and Phones for Video Monitoring

See these sections for information updating camera and IP phone firmware and preparing phones and cameras for video monitoring:

- [Obtaining the Latest SPA525G/SPA525G2 Phone Firmware](#)
- [Setting Up Cisco 2300 Series Business Internet Cameras](#)

#### Obtaining the Latest SPA525G/SPA525G2 Phone Firmware

Version 7.4.3 or later of the SPA525G phone firmware is required for enabling video on SPA525G phones. Version 7.4.5 or later of the SPA525G2 phone firmware is required for SPA525G2 phones.

Version 7.4.3 of the SPA525G phone firmware is provided in the UC500 software pack version 8.0.1. To obtain the SPA525G software, you can either install the 8.0.1 software pack on the UC500 or download the SPA525G version 7.4.3 or later phone firmware from Cisco.com and use the drag-and-drop method to upload the firmware to the UC500.

The SPA525G2 phones are shipped from the factory with version 7.4.5 phone firmware installed.

### Setting Up Cisco 2300 Series Business Internet Cameras

Follow these steps to set up and prepare Cisco 2300 Series Business Internet Video Cameras for use with the CCA Video Monitor Setup wizard. You will need to

- Unpack and set up the camera hardware.
- Download the latest camera firmware from Cisco.com.
- Connect your PC to each camera and run the Setup CD that ships with the camera to configure basic settings.
- Assign a static IP address and upgrade the firmware on each camera.
- For WVC2300 (wireless) IP cameras, you must configure the wireless network SSID settings cameras to match those on the data SSID for access points and the UC500.
- Create a CCA customer site and add the cameras to the site so that you can use CCA to configure video monitoring on Cisco SPA525G/G2 IP phones.

---

**STEP 1** Download version 1.1.1.4 or later of the Cisco 2300 Series Business Internet Video Cameras to the PC running CCA.

Version V1.1.1.4 or later of the camera firmware is required.

This software is available on Cisco.com in the following locations:

- Cisco PVC2300 and WVC2300 product pages (Cisco.com U.S. site only).
  - **PVC2300:** [www.cisco.com/go/pvc2300software](http://www.cisco.com/go/pvc2300software)
  - **WVC2300:** [www.cisco.com/go/wvc2300software](http://www.cisco.com/go/wvc2300software)

On the Resources tab, scroll down to the Firmware section and click **Download Firmware and Accept License Agreement for Cisco PVC2300 Business Internet Video Camera - Audio/PoE**, or  
or,

**Download Firmware and Accept License Agreement for Cisco WVC2300 Wireless-G Business Internet Video Camera - Audio.**

The files are named PVC2300\_Firmware.zip and WVC2300\_Firmware.zip.

- Cisco Software Download Center (requires Cisco.com login), at  
<http://www.cisco.com/public/sw-center/index.shtml>

In the Select a Product Category box, choose **Security > Cisco Physical Security > Cisco Small Business Video Surveillance Cameras (Linksys Business Series)** and select the camera model.

**STEP 2** Unzip the camera firmware files that you downloaded: **PVC2300\_Firmware.zip**, **WVC2300\_Firmware.zip**.

When upgrading the camera firmware using CCA, you will need the **WVC2300 FW\_V111R04.bin** file or the **PVC2300 FW\_V111R04.bin** file, depending on the camera model you are using.

**STEP 3** Unpack and set up the camera hardware as described in the *Cisco PVC2300, WVC2300 Business Internet Video Camera with Audio Quick Start Guide*. This guide is available on Cisco.com at the following URL:

[http://www.cisco.com/en/US/products/ps9944/prod\\_installation\\_guides\\_list.html](http://www.cisco.com/en/US/products/ps9944/prod_installation_guides_list.html)

**STEP 4** Connect the cameras to the UC500 as described in the *Quick Start Guide* and apply power.

The Cisco PVC2300 camera can be connected to a PoE port on the UC500 or ESW500 Series switch. The Cisco WVC2300 camera uses a power adapter that is supplied with the camera.

**STEP 5** Follow the instructions in the *Cisco PVC2300, WVC2300 Business Internet Camera with Audio Administration Guide* for using the Setup CD to install the software and configure basic network settings.

- Accept the license agreement
- Log in as administrator (admin/admin is the default login).
- Configure basic camera settings (camera name, description, time zone, date, and time).
- On the Network Settings page of the Setup program, choose **Fixed IP Address** for the configuration type and enter a static IP address to use for the camera (192.168.10.x).

By default, the PVC2300 and WVC2300 cameras use DHCP to obtain an IP address. However, a static IP address must be configured on the cameras to ensure that IP address of the camera always matches the camera IP address configured on the phones. The Video Monitor Setup wizard reads in the IP address configured on the cameras.

- Confirm your settings and exit the setup wizard.

- If you are configuring WVC2300 (wireless, non-PoE) cameras, follow the instructions in the camera administration guide for configuring wireless settings. The wireless network name (SSID) and security settings configured on the cameras must match the SSID settings for the data network on the access points and UC500.

- STEP 6** Upgrade the camera firmware for each camera. Firmware version 1.1.1 or later is required.
- a. From a PC connected to the local network (LAN), launch a web browser and connect to the camera using the static IP address you assigned to the camera (for example, 192.168.10.21).
  - b. Log in as administrator.
  - c. Click **Setup** on the toolbar.
  - d. Click **Administration > Firmware**. The current version is displayed. If the version is prior to 1.1.1.4, click **Upgrade** and follow the onscreen instructions.
  - e. When prompted to choose an upgrade file, browse to the **WVC2300 FW\_V111R04.bin** file or the **PVC2300 FW\_V111R04.bin** file on your local PC, depending on the camera model you are using.
  - f. Repeat these steps for each camera.

**STEP 7** If you have not already done so, launch CCA and create a CCA customer site.

**STEP 8** With the PC running CCA connected to the UC500 LAN, connect to the customer site that contains the UC500.

**STEP 9** Choose **Home > Topology** to display the Topology view.

If the cameras you are connecting have already been upgraded to the correct software, they are displayed in the Topology view.

**STEP 10** Click the Refresh icon in the Topology view, then right click on each camera and choose **Add to Site**.

You are now ready to launch the Video Monitor Setup Wizard. See [Launching and Using the Video Monitor Setup Wizard, page 106](#).

## Backing Up and Restoring Device Configuration

To access backup and restore options, choose **Maintenance > Configuration Archive** from the feature bar.

### Overview

This section provides instructions for backing up the startup configuration of all devices or a single managed device to your PC or a network drive and how to restore a previously backed up configuration.

In addition to the startup configuration, these files and directories on the UC500 flash are also backed up and restored:

- System speed dial configuration
- vlan.dat file (VLAN configuration)
- Directories on the flash for BACD prompts, phone desktop images, media (Music On Hold files), and ringtones
  - flash:bacdprompts/
  - flash:Desktops/
  - flash:ringtones/
  - flash:media/

If the UC500 being backed up still has a flat directory structure retained from a prior release, only the startup configuration, VLAN configuration, and speed dials are backed up and restored.

### Procedures

This section covers these topics:

- [To Back Up a Configuration, page 113](#)
- [To Restore a Configuration from a Backup, page 113](#)
- [Backup Preferences, page 114](#)



---

#### To Back Up a Configuration

Follow these steps to back up the startup configuration of managed device or all devices:

- 
- STEP 1** From the Configuration Archive window, click the **Back Up** tab.
  - STEP 2** From the Hostname list, select **All Devices** or the device with the startup configurations that you want to back up.
  - STEP 3** In the **Backup Note** text area, enter any information that will later help you to identify a backed-up configuration as the one that you want to restore.
  - STEP 4** Click **Back Up**.

Configuration backups are archived to the directory shown in the Backup Directory field, and the event is recorded on the Restore tab.

**TIP** You can delete archived configurations that accumulate in the backup directory. The default directory is C:\Documents and Settings\*username*\.configuration assistant\backups.

- STEP 5** Click **OK**.

---

#### To Restore a Configuration from a Backup

**IMPORTANT** You can only restore a configuration to the same UC500 hardware on which you performed the backup. Configuration migration between two separate UC500 systems is not supported.

To restore a previously backed up configuration to the startup configuration of a managed device, follow these steps:

- 
- STEP 1** In the Configuration Archive window, select the device in the Hostname list that you want to restore to.
  - STEP 2** Click a button to determine the range of backed-up configurations shown in the Back-Up Configurations list.

The top button displays only the backed-up configurations from the device that you selected. The middle button displays the backed up configurations from the device that you selected and from any other devices in your customer site of the same device type. The bottom button displays all the backed-up configurations in the backup directory.

**STEP 3** From the Backed-Up Configurations list, select a configuration to restore.

Look at the contents of the Backup Note text area to confirm that the selected configuration is really the one that you want.

**STEP 4** Click **Restore**.

**STEP 5** Click **Restart** to restart the device after a configuration has been restored to it.

---

### Backup Preferences

To back up to a different directory, click **Preferences** from the Configuration Archive window or choose **System > Preferences** from the feature bar.

In the Preferences window, choose the Configuration Archive tab and enter a different path and directory.

The tab also has an option to automatically save the running configuration before you back up. If you do not select it, CCA prompts you to save the running configuration if it differs from the startup configuration.

## Using CCA with Cisco Small Business Office Manager

Cisco Small Business Office Manager is a no-cost desktop application that is designed for a small business office administrator or IT person. Office Manager provides the office administrator or IT person with the ability to independently perform routine operational tasks for the Cisco Smart Business Communications System.

A Cisco partner configures the system, using CCA, then customizes the Cisco Office Manager application and leaves it behind, enabling the site administrator to modify the system's voice and user settings, easily see video streams from IP cameras, and view network status. Cisco partners can work with their customers to determine what features the site administrator will be able to control.

For product information and a link to download the Office Manager software, visit [www.cisco.com/go/officemanager](http://www.cisco.com/go/officemanager)

Office Manager installation documentation is avail at the following URL:

[www.cisco.com/en/US/products/ps11199/prod\\_installation\\_guides\\_list.html](http://www.cisco.com/en/US/products/ps11199/prod_installation_guides_list.html)

## Resources for Planning and Implementing Your SBCS Solution

These resources are provided by Cisco for planning and implementing your SBCS solution:

- [Cisco Small Business Support Community, page 115](#)
- [Cisco Smart Designs, page 116](#)
- [Cisco UC540 and UC560 Platform Reference Guides, page 116](#)

### Cisco Small Business Support Community

The Cisco Small Business Support Community site provides resources to assist VARs and Partners with design, implementation, and maintenance for Cisco SBCS platforms.

To access the Cisco Small Business Support Community:

- From within CCA, choose **Partner Connection > SB Support Community**, or
- Open a Web browser and go to this URL:  
[www.cisco.com/go/smallbizsupport](http://www.cisco.com/go/smallbizsupport)

These resources include:

- Support areas organized around a product, technology, or country  
To go to the Cisco Smart Business Communications System/UC500 support area, select **Support Areas > Voice and Conferencing > SBCS/UC500**.
- Discussion forums (requires a Cisco.com login to post messages, but not to read messages)
- Training resources, including a library of support video on demand (VOD) and tutorials
- Links to Cisco support resources:
  - Sales support tools
  - Design and deployment tools
  - Configuration guides and application notes
  - UC500 software downloads

- SBCS warranty information
- Small & Medium Business (SMB) University

## Cisco Smart Designs

Cisco's SBCS Smart Design documents provide best practices for network solution design and implementation. These simplified and pre-tested networking solutions are intended to minimize complexity and risk while maximizing partner success. A Partner login is required for access.

Visit this URL to view SBCS Smart Design documents:

[www.cisco.com/go/partner/smartdesigns](http://www.cisco.com/go/partner/smartdesigns)

## Cisco UC540 and UC560 Platform Reference Guides

To learn more about the capabilities and features of the Model UC540 and UC560 platform, refer to the following guides, available on Cisco.com.

- *Cisco Unified Communications 500 Series Model 560 for Small Business: Platform Reference Guide*

[www.cisco.com/en/US/prod/collateral/voicesw/ps6788/vcallcon/ps7293/reference\\_guide\\_c07-566560.html](http://www.cisco.com/en/US/prod/collateral/voicesw/ps6788/vcallcon/ps7293/reference_guide_c07-566560.html)

- *Cisco Unified Communications 500 Series Model 540 for Small Business: Platform Reference Guide*

[www.cisco.com/en/US/prod/collateral/voicesw/ps6788/vcallcon/ps7293/C78-557768-00\\_540\\_platform\\_reference\\_guide\\_DS\\_v2a.html](http://www.cisco.com/en/US/prod/collateral/voicesw/ps6788/vcallcon/ps7293/C78-557768-00_540_platform_reference_guide_DS_v2a.html)

These platform reference guides cover part numbers, available interfaces and modules, licensing, basic call center capabilities, voice resource utilization for conferencing and transcoding, localization support, and hardware specifications for the UC540 and UC560 models.

## Cisco SBCS Features Supported Within CCA

The *Cisco Smart Business Communications System Feature Reference Guide* provides guidance to partners on the features that can be configured using the latest releases of CCA. The information is categorized by Voice, Switching, Wireless, and Security.

---

This guide is available on the Resources tab on the main Cisco Smart Business Communications product page ([www.cisco.com/go/sbcs](http://www.cisco.com/go/sbcs)). From within CCA, you can choose **Partner Connection > SBCS Feature Guide** to access the guide.



# Device Properties

This section covers configuration of these device properties:

- **Hostname**
- **System Time**
- **Time Zone (SA500 Security Appliances Only)**
- **HTTP Port**
- **Users and Passwords**
- **Remote Device Access (Telnet)**
- **SNMP**

## Hostname

To modify the hostname for a device:

- Choose **Configure > Device Properties > Hostname** on the feature bar.
- Right-click on a device in the Topology view and choose **Hostname** from the popup menu.

### Overview

You can give a hostname to an unnamed member of a customer site, or you can change its hostname.

The hostname is displayed in system prompts and in the drop-down Hostname menu in CCA configuration windows.

The name change does not take effect immediately. A message in the status bar shows when the change has occurred.

### Procedures

To modify the hostname for a device, follow these steps:

- 
- STEP 1** In the **Hostname** list, select the device whose name you want to change.
  - STEP 2** If you selected a device from the Topology view before opening the Hostname window, the Hostname is preset to your selection.
  - STEP 3** In the **New Hostname** field, enter a unique name for the device. The maximum length of a hostname is 31 characters.
  - STEP 4** Click **OK**. The Topology view is redisplayed with the new name shown for the device.
  - STEP 5** Save the configuration (**Configure > Save Configuration**).
- 

## System Time

To configure system time settings, choose **Configure > Device Properties > System Time**.

**IMPORTANT** You cannot set system time options for the SA500 from this window. To configure time zone and NTP server settings for the SA500, choose **Configure > Device Properties > Time Zone**. See [Time Zone \(SA500 Security Appliances Only\)](#), page 126.

### Overview

From the System Time window, you can

- Manually configure the time and daylight saving time on your network devices,
- Configure NTP (Network Time Protocol) so that the devices request time updates from an NTP server, or
- Synchronize the time on devices to the PC time or to the system time on a particular device.



Generally, you do not need to set the system clock if the system is synchronized by an outside timing mechanism such as NTP. If no other time source is available, you should manually set the time. The time specified is relative to the configured time zone.

See these sections for instructions:

- [Display the Current Time](#)
- [Set the System Time](#)
- [Synchronize System Time](#)
- [Configure NTP](#)

### Display the Current Time

The System Time window automatically displays the current time: hours (in 24-hour format), minutes, time zone, month, date, and year for all the devices in a community.

Here are some examples of date/time formats:

- Month, date, and year: **August/2/2005**.
- Hours and minutes: **9:00** (for 9 a.m.) or **13:00** (for 1 p.m.).
- Time zone: **(GMT -10:00) Hawaii**, meaning it is 10 hours behind Greenwich Mean Time.

### Set the System Time

From the System Time window, you can:

- Manually set or modify the time on one or more devices.
- Synchronize the time across devices in a customer site.

To manually set or modify the system time on a device:

---

**STEP 1** Select the row for the device.

**STEP 2** Select the month, day, year, hour and minutes from the drop-down lists in the cells of the row.

Your hour selection must be based on 24-hour format. For example, for 9 a.m., enter **09**; for 1 p.m., enter **13**; for midnight, enter **24**.

---

**STEP 3** Select the correct time zone from the drop-down lists.

The full range of Universal Time Coordinated (UTC) offsets is supported. UTC is the same as Greenwich Mean Time. The offset (difference between UTC and the time zone of the switch) can be a negative or positive number.

For example, Pacific Standard Time has an offset of -8 hours, meaning it is 8 hours behind UTC. Each time zone is displayed with the UTC offset and the major cities or states in that region.

**STEP 4** Select **Automatic Daylight Saving Adjustment** to configure automatic daylight saving time.

Automatic daylight saving is only supported in the U.S.A, Australia, Canada, and Europe, and it begins on the day and time that is set in the local region.

**STEP 5** Click **OK**.

---

To manually set or modify the system time on multiple devices:

---

**STEP 1** Select the rows for the devices.

**STEP 2** Click **Modify**.

**STEP 3** Complete the Modify System Time window, and click **OK** to save your changes. See [Modify System Time, page 123](#).

**STEP 4** Click **Apply** in the System Time window to put your changes in effect.

**STEP 5** Click **Refresh** to update the window.

---

### Synchronize System Time

To synchronize the time settings across devices in a community:

---

**STEP 1** Click **Sync** to synchronize all the devices in the site. To synchronize specific devices, select the rows of the devices and click **Sync**.

**STEP 2** Complete the Synchronize System Time window, and click **OK** to save your changes. See [Synchronize System Time, page 125](#).

---

**STEP 3** Click **Apply** in the System Time window to put your changes in effect.

**STEP 4** Click **Refresh** to update the System Time window.

---

### Configure NTP

To configure an NTP server:

---

**STEP 1** In the System Time window, click NTP.

**STEP 2** Complete the fields in the Network Time Server window. See [Network Time Server, page 124](#).

**STEP 3** Click **Apply** to put your changes in effect.

**STEP 4** Click **Refresh** to update the System Time window.

---

For more information, see these topics:

- [Modify System Time, page 123](#)
- [Synchronize System Time, page 125](#)
- [Network Time Server, page 124](#)

### Modify System Time

This window appears when you select one or more devices and click **Modify** in the System Time window.

**NOTE** If you selected multiple devices that have different settings, the fields for those settings appear blank. If the selected devices have the same settings, the settings appear.

---

**STEP 1** In the **Date and Time** area, select the correct month, day, and year from the drop-down lists.

**STEP 2** Select the correct hour and minutes from the drop-down lists.

Your hour selection must be based on 24-hour format. For example, for 9:00 a.m., enter **09**; for 1:00 p.m., enter **13**.

**STEP 3** Select the correct time zone from the drop-down lists.

---

The full range of Universal Time Coordinated (UTC) offsets is supported. UTC is the same as Greenwich Mean Time. The offset (difference between UTC and the time zone of the switch) can be a negative or positive number.

For example, Pacific Standard Time has an offset of -8 hours, meaning it is 8 hours behind UTC. Each time zone is displayed with the UTC offset and the major cities or states in that region.

- STEP 4** Select **Enable** from the drop-down list to configure automatic daylight saving time. Select **Disable** to disable automatic daylight saving time.

Automatic daylight saving is only supported in the U.S.A., Canada, Australia, and Europe, and it begins on the day and time that is set in the local region.

- STEP 5** When you have made your changes, click **OK**. The System Time window appears.

---

## Network Time Server

This window appears when you click **NTP** in the System Time window.

Use this window to configure the NTP (Network Time Protocol) client if you want it to regularly send time-of-day requests to an NTP server. The NTP server then synchronizes the client system clock to the server clock when the device requests it.

To enhance security, you can configure NTP authentication. When NTP authentication is set, the device updates the time only if a server provides the correct authentication. For authentication to work properly, you must first obtain the key information from the server administrator and enter it in the NTP Authentication fields.

To configure devices to receive time updates from an NTP server and to configure NTP authentication:

- 
- STEP 1** In the **IP Address** field, enter the IP address of the time server.
- STEP 2** *Optional:* In the **Key ID** field, specify the authentication key to use when sending packets to the server. Enter a number from 1 to 4294967295.
- STEP 3** *Optional:* In the **Key Value** field, enter the secret key. Enter up to 32 printable characters, excluding spaces, !, ", #, \$, }, |, and ~.
- STEP 4** *Optional:* In the **Encryption Type** field, enter the number used to encrypt the key value. Enter a number from 1 to 4294967295.

- 
- STEP 5** Click **OK** to close the Network Time Server window and return to the System Time window.
- 

## Synchronize System Time

This window appears when you click **Sync** or when you select one or more devices and click **Sync** in the System Time window.

### Overview

This window displays the current time on the PC.

You can synchronize the system time on selected devices to the current time on the PC, or you can synchronize to the system time of a specific device. You can also overwrite the time zone setting on the selected devices.

For example, if you synchronize the system time of a device in New York with the time setting of a device in San Jose that has a time of 1 p.m. (PST), after the synchronization takes place, the device in New York displays the new time setting of 4 p.m. EST. However, if you select the checkbox **Overwrite Local Time Zone**, the device in New York has the new time setting of 1 p.m. PST (the same as the device in San Jose). The local time is overwritten.

### Procedures

To synchronize the system time on selected devices to the current time on the PC:

- 
- STEP 1** Select **Sync to PC**.
- STEP 2** Select **Overwrite Local Time Zone** setting if you want to overwrite the local time zone setting in the selected devices.
- STEP 3** Click **OK** to save changes and to return to the System Time window.
-

To synchronize the system time on selected devices to the system time of a specific device:

- 
- STEP 1** Select **Sync to Device**.
  - STEP 2** Select the device (that you want to use synchronize with) from the pull-down list.
  - STEP 3** Select **Overwrite Local Time Zone** setting if you want to overwrite the local time zone setting in the selected devices.

Click **OK** to save changes and to return to the System Time window.

---

## Time Zone (SA500 Security Appliances Only)

The Time Zone Management window displays when you choose **Configure > Device Properties > Time Zone** from the feature bar. This option is available only if you are connected to a standalone SA500 Series Security Appliance or one is present in the CCA customer site.

### Overview

From the Time Zone Management window, you can:

- Set the Time Zone on the SA500
- Choose whether you want to automatically adjust for daylight savings time
- Specify whether to use the default NTP servers for system time updates or enter up to 2 custom NTP servers
- View the current time on the SA500

You cannot manually set a system time on the SA500.

## Procedures

To manage Time Zone settings on the SA500, complete the settings as described in the following table, then click **OK** or **Apply**.

Setting	Description
<b>Hostname</b>	Hostname of the SA500 you are configuring. The default is SA500.
<b>Time Zone</b>	<p>Select the correct time zone from the drop-down lists.</p> <p>The full range of Universal Time Coordinated (UTC) offsets is supported. UTC is the same as Greenwich Mean Time. The offset (difference between UTC and the time zone of the switch) can be a negative or positive number.</p> <p>For example, Pacific Standard Time has an offset of -8 hours, meaning it is 8 hours behind UTC. Each time zone is displayed with the UTC offset and the major cities or states in that region.</p>
<b>Automatically Adjust for Daylight Savings Time</b>	<p>When this box is checked, the system time on the SA500 is automatically adjusted for daylight saving time.</p> <p>Automatic adjustment for daylight saving is only supported in the U.S.A., Canada, Australia, and Europe, and it begins on the day and time that is set in the local region.</p>
<b>Use Default NTP Servers</b>	Configure the SA500 to receive time updates from the default NTP (Network Time Protocol) servers. The default servers are <code>0.us.ntp.pool.org</code> and <code>1.us.ntp.pool.org</code> .
<b>Use Custom NTP Servers</b>	When this option is checked, you can specify up to two custom NTP servers to use for time updates.
<b>NTP Server 1 NTP Server 2</b>	If Use Custom NTP Servers is checked, enter the hostname or public IP address of the NTP servers in these fields.
<b>Current Time</b>	Read-only display of the current date and time on the SA500, for example, Saturday, January 01, 2010, 22:24:24 (GMT +0000).

---

## HTTP Port

To change the HTTP port number for all the devices in a customer site, choose **Configure > Device Properties > HTTP Port** from the feature bar.

### Overview

Configuration Assistant connects to every device in a customer site through an HTTP or HTTPS port.

- You can change the HTTP port number but not the HTTPS port number.
- For HTTPS, the default of 443 is always used.

HTTPS ensures that communications between Configuration Assistant and the managed devices are encrypted. You can use HTTPS only with a crypto image of Cisco IOS.

The first time that you connect with HTTPS, you see an alert. It asks whether you will accept a certificate that asserts the connected device is a trusted site. Your choices are **Yes**, **No**, **Always**, and **View Certificate**.

Answer **Yes** or **Always** to continue. You will not be alerted in later Configuration Assistant sessions if you answer **Always**.

When HTTPS is in use, you see an icon in the status bar.

### Procedures

To configure the HTTP port, follow these steps.

- 
- STEP 1** Enter a different port number in the **HTTP Port** field. The default port number is 80. The range of other valid port numbers is 1025 to 65535.

Click **OK**. The new HTTP port number is propagated to all the members of the customer site.

---



## Users and Passwords

To set up passwords and to associate passwords with usernames and privilege levels, choose **Configure > Device Properties > Users and Passwords**.

### Overview

You can manage access to CCA by setting up passwords alone or passwords paired with usernames. You can also associate a privilege level with a password and username to manage access on a user by user basis.

Depending on the type of device being configured, different types of privileges can be assigned.

- For Cisco Small Business Pro SA500 Security Appliances privilege levels include Guest (read-only access), Admin, and SSL VPN User.
- For Cisco AP54 1N access points:
  - You cannot create additional users or modify the default administrative username (cisco) and privilege level (Admin).
  - You can only modify the default administrator password (cisco).
- For Cisco Model PVC2300 and WVC2300 Business Internet Cameras:
  - Different privilege levels apply (Admin, Monitor, and Viewer).
  - You cannot modify the default administrator username (admin), but you can create additional users with Admin privileges.
- For the UC500 and other Cisco IOS-based devices, privilege levels range from 1 to 15:
  - Privilege level 15 gives read-write access. Users at this level can see and configure all the options in CCA.
  - Privilege levels 1 to 14 give read-only access. Options on the feature bar, toolbar, popup menus, and feature windows that can change a device configuration are not shown.

To set up passwords and to associate passwords with usernames and privilege levels, use the Users and Passwords window.

### Procedures

From the Users and Passwords window, you can:

- **Give Access to All Site Devices**

- **Give Access to a Specific Device**

Begin by selecting **All Devices** or a specific device in the **Hostname** list.

Click **OK** when you finish configuring users and passwords.

### **Give Access to All Site Devices**

To give access to all devices in the customer site, follow these steps:

- 
- STEP 1** In the **Admin Username** field, enter the username that an administrator will use to access all the devices in the community.
  - STEP 2** In the **Password** field, enter the password that the administrator will use. The entry is encrypted and shown as asterisks.
  - STEP 3** Enter the password again in the **Confirm Password** field.
- 

### **Give Access to a Specific Device**

**NOTE** Username, password, and device access options vary, depending on the device or devices selected. If a tab is not displayed for a device, that device does not support that option.

Use these tabs to give access to a specific device:

- **Local Username/Password**, to associate usernames and passwords with privilege levels
- **HTTP Authentication**, to specify whether users enter both a username and password or only a password to access Configuration Assistant
- **Enable Password**, to associate passwords with privilege levels
- **Console/Telnet Password**, to associate passwords with the console line and Telnet sessions

### **Local Username/Password**

This tab shows usernames, passwords, and their associated privilege levels. Users with a paired username and password on this tab have access to CCA at the associated privilege level.

Options for local username and password configuration vary, depending on the device you are configuring.

For Cisco AP541N access points:

- You cannot create additional users or modify the default administrative username (cisco) and privilege level (Admin).
- You can only modify the default administrator password (cisco).

To enter a new user access record—a new username, password, and privilege level—click **Create** and use the Create Local Username/Password window. See [Create User, page 132](#).

To modify the password or privilege level in a user access record, select it, click **Modify**, and use the Modify Local Username/Password window.

To delete a user access record, select it, and click **Delete**.

### HTTP Authentication

On this tab, click **Enable Password** if you want users to access the selected device by entering only a password. Click **Local User Name/Password** if you want them to enter both a username and password.

Be sure to also use the **Enable Password** tab to set up passwords or the **Local User Name/Password** tab to set up usernames and passwords.

### Enable Password

This tab shows privilege levels and passwords. Users who enter a password that is on this tab have access to Configuration Assistant at the associated privilege level.

To create a new password and an associated privilege level, click **Create**, and use the Create Enable Password window.

**NOTE** If a password exists for every privilege level from 1 to 15, the **Create** button is disabled.

To modify a password, select it, click **Modify**, and use the Modify Enable Password window. See [Modify Enable Password, page 134](#).

To delete a password, select it, and click **Delete**. Both the password and its privilege level are removed from the tab.

### Console/Telnet Password

This tab shows the passwords that are associated with the console line and Telnet sessions.

In a Telnet session, a Telnet password gives users read-only access to a device. They cannot configure the device. When they telnet to the device, they are prompted for the password, which they share. They are not prompted for a username. If you do not enter a Telnet password or remove it, users are prompted for their username and password on the **Local Username/Password** tab.

Entering a console password gives users read-write access. If you created an enable password, users must enter it instead of the console password to have read-write access.

To create passwords or to change them, enter them in the **Password** field, and enter them again in the **Confirm Password** field.

## Create User

This window appears when you click **Create** on the Local Username/Password tab of the Users and Passwords window. Use it to specify a username, a password, and an associated privilege level.

Available options vary, depending on the device you are configuring.

Follow these steps:

- 
- STEP 1** In the **Username** field, enter the name that a user will use to access Configuration Assistant.
  - STEP 2** In the **Password** field, enter the password that a user will use. The entry is encrypted.
  - STEP 3** Enter the password again in the **Confirm Password** field.
  - STEP 4** From the Privilege Level list, select a privilege level. Depending on the device you are configuring, different options for Privilege Level are displayed.

For UC500 platforms and other IOS devices, Level 15 grants read-write access; levels 1 to 14 grant read-only access.

For SA500 Security Appliances, you can also set the Privilege Level to Guest (for read-only access) and SSL VPN User.

For Cisco Model PVC2300 and WVC2300 Business Internet Cameras, choose one of these privilege levels:

- **Admin** — Allows the user to administer and control camera and video.
- **Monitor** — Allows the user to control camera video (manually pan/tilt, toggle between day/night vision, and trigger output ports). Camera users added through the Video Monitor Setup wizard are assigned Monitor privileges.
- **Viewer** — Allows the user to view video from the camera using a Web browser, IP phone, or other application.

**STEP 5** Click **OK**. When you return to the Users and Passwords window, you see a new entry on the Local Username/Password tab.

---

## Modify User Password

This window appears when you select an entry and click **Modify** on the Local Username/Password tab of the Users and Passwords window. Use it to modify the password and privilege level associated with a username.

Follow these steps:

- 
- STEP 1** If you want to change the password, enter a different password in the **Password** field. Your entry is encrypted and shown as asterisks.
- STEP 2** Enter the password again in the **Confirm Password** field.
- STEP 3** If you want to change the privilege level, select a different privilege level from the Privilege Level list.
- STEP 4** Click **OK**.
-

## Modify Enable Password

This window appears when you select a password and click **Modify** on the Enable Password tab of the Users and Passwords window. Use it to modify the password for the associated privilege level.

Follow these steps:

- 
- STEP 1** In the **Password** field, enter a different password for the displayed privilege level. Your entry is encrypted and shown as stars.
  - STEP 2** Enter the password again in the **Confirm Password** field.
  - STEP 3** Click **OK**.
- 

## Remote Device Access (Telnet)

Remote access through Telnet is always enabled, since CCA will not function properly without Telnet access. The Device Access window that was included in prior releases of CCA has been removed, and CCA no longer uses SSH.

## SNMP

To configure SNMP (simple network management protocol) settings, choose **Configure > Device Properties > SNMP Management**.

### Overview

Managing SNMP includes these tasks:

- Disabling or enabling SNMP on a standalone switch
- Setting system options
- Adding and removing community strings
- Adding and removing trap managers
- Creating views of MIB objects that are accessible to groups of users
- Associating views with the groups that can access them

- Associating groups with the users that belong to them

### Procedures

The window has these tabs:

- **System Options**, to assign administrative information to a device to help identify it
- **Community Strings**, to add and remove community strings
- **Trap Managers**, to add and remove trap managers
- **Filter (ESW500 Series Switches)**, to create sets of traps that can be sent to trap manager (Cisco ESW500 Series switches only)
- **Views**, to create views of MIB objects that are accessible to groups of users
- **Groups**, to associate views with the groups that can access them
- **Users**, to associate groups with the users that belong to them

Available tabs and SNMP configuration options vary among devices. Not all devices support all of these SNMP configuration options through CCA.

Begin by:

- Selecting a device from the **Hostname** list. The tabs and their settings apply to the selected device. You see the **Views**, **Groups**, and **Users** tabs only if the device supports SNMP Version 3 or later.
- Ensuring that **Enable SNMP** is checked.

When you have finished entering settings on the tabs, click **OK**.

---

## System Options

Although SNMP allows a maximum of 255 characters for each field on this tab, Configuration Assistant truncates this information to shorter lengths. For this reason, we recommend shorter entries. See individual steps in the procedure below for guidelines.

To assign system options:

- 
- STEP 1** In the **System Location** field, enter the physical location of the device. The maximum length of an entry in the **System Location** field is 129 characters.
  - STEP 2** In the **System Contact** field, enter the name or organization responsible for the device. The maximum length of an entry in the **System Contact** field is 129 characters.
- 

## Community Strings

Community strings serve as passwords to authenticate SNMP messages. Each community string is either read-only (RO), which allows MIB-object information to be displayed, or read-write (RW), which allows MIB-object information to be displayed and modified.

The first read-only and first read-write community strings are listed on the SNMP Management window. Because they are necessary for SNMP packet routing, they should not be removed on any device.

The SNMP configuration can also contain user-defined community strings.

If your access mode is read-only, you do not see community strings in this list.

## Adding Community Strings

The selected device supports an unlimited number of community strings of any length.

To add a new community string to a device:

- 
- STEP 1** In the **New String** field, enter a character string.
  - STEP 2** Select **RO** (read only) or **RW** (read-write) to specify the string type.
  - STEP 3** Click **Add** to move the new community string to the **Current Strings** list.
-



---

### Removing Community Strings

Do not remove the first read-only or the first read-write community string. These strings are required for SNMP functions.

To remove an existing community string:

- 
- STEP 1** In the **Current Strings** list, select the community strings to be deleted.
  - STEP 2** To remove all community strings, click **Select All**.
  - STEP 3** Click **Remove**.
- 

### Trap Managers

A trap manager is a management station that receives traps, the system alerts generated by a device. By default, no trap manager is defined, and no traps are sent.

To enable the selected device to send traps, check **Enable Traps**. Then check the boxes for the trap types that you want to enable for each IP destination.

To add a new trap manager:

- 
- STEP 1** In the **IP Address** field, enter the IP address of the new trap manager.
  - STEP 2** In the **Community String** field, enter the community string for the new trap manager.
  - STEP 3** In the **UDP-Port** field, enter the UDP port of the trap manager to which the traps should be sent.
  - STEP 4** To send every trap type to the trap manager, check **Send All Traps**. Otherwise, check only the trap types that you want to send.
  - STEP 5** For a description of the trap types, refer to the documentation for the selected device.
  - STEP 6** *Optional.* If you are configuring a trap manager for an ESW500 Series switch, you can select a filter to apply to this Trap Manager, if any have been defined.
  - STEP 7** Click **Add** to move your entry to the **Current Managers** list.
- 

If your access mode is read-only, you do not see trap managers and their community strings in this list.

---

---

To remove a trap manager:

- STEP 1** In the **Current Managers** list, select the trap managers to be deleted.
  - STEP 2** To remove all existing trap managers, click **Select All**.
  - STEP 3** Click **Remove**.
- 

### Filter (ESW500 Series Switches)

The Filter tab applies to Cisco Small Business Pro ESW500 Series switches only.

This tab enables you to create, modify, and delete SNMP filters. An SNMP filter defines a set of traps that are forwarded to a trap manager. Filters that you create on this tab can be selected on the Trap Managers tab.

To create a filter, follow these steps.

- 
- STEP 1** Click **Create**.
  - STEP 2** In the Create an SNMP Trap Filter window, enter a descriptive Filter Name, from 1 to 30 characters (spaces are not allowed). After you apply changes, this name is displayed in the Select Filter menu on the Trap Managers tab.
  - STEP 3** Select one or more OIDs from the Available list and use the **Add**, **Remove**, and **Select All** buttons to move OIDs from the Available to the Selected list.
  - STEP 4** Click **OK** to close the Create an SNMP Trap Filter window.
  - STEP 5** In the SNMP Management window, click **Apply** or **OK**.
- 

To delete a filter, select the filter to be deleted from the list and click **Delete**. You can only delete filters that are not being used. If the filter is currently being used by any Trap Managers, you will be prompted to remove the filter from the Trap Manager before it can be deleted.

To modify a filter, select the filter to be modified and click **Modify**.

### Create or Modify SNMP Filter (ESW500 Series)

This window appears when you choose **Create** or **Modify** on the Filter tab in the SNMP Management window for Cisco ESW500 Series switches.

From this window, you can create or modify SNMP filters. An SNMP filter defines a set of traps that are forwarded to a trap manager. Filters that you create in this window can be selected on the Trap Managers tab in the SNMP Management window.

To create or modify an SNMP filter, follow these steps.

- 
- STEP 1** Enter a descriptive **Filter Name**, from 1 to 30 characters (spaces are not allowed). After you apply changes, this name is displayed in the Select Filter menu on the Trap Managers tab.
  - STEP 2** Use the **Add**, **Remove**, and **Select All** buttons to move OIDs from the Available to the Selected list.
  - STEP 3** Click **OK**.
- 

### Views

This tab shows the names of the views, collections of MIB objects to which user groups can have:

- Read access
- Write access
- Notification privileges

To create a view and add its name to this tab, click **Create**, and use the Create SNMP View window. See [Create SNMP View, page 140](#).

To modify a view, select it, click **Modify**, and use the Modify SNMP View window.

To delete a view, select it and click **Delete**.

You cannot delete or modify the **v1default** view.

---

## Create SNMP View

This window appears when you click **Create** on the Views tab of the SNMP window.

To create an SNMP view, follow these steps.

- 
- STEP 1** Enter a name for the view in the **View Name** field.
  - STEP 2** Select one or more OIDs-MIB object IDs-from the OIDs list. To select all the OIDs, click **Select All**.
  - STEP 3** Click **Add** to move the selected OIDs into the Included OIDs list. These are the OIDs that will make up the new view. To move OIDs back to the OIDs list, select them and click **Remove**.
  - STEP 4** Click **OK**. The name of the created view is listed on the Views tab of the SNMP window.
- 

## Modify SNMP View

This window appears when you select a view and click **Modify** on the Views tab of the SNMP window.

To modify the SNMP view, follow these steps.

- 
- STEP 1** From the OIDs list, select any OIDs that you want to add to the view. Then click **Add**.
  - STEP 2** From the Included OIDs list, select any OIDs that you want to remove from the view. Then click **Remove**.
  - STEP 3** Click **OK**.
-

## Groups

The columns on this tab have these meanings:

Column	Meaning
<b>Group</b>	The name of a group of users
<b>Security Level</b>	Whether users are required to enter a password ( <b>Authenticate</b> ) and whether the password is encrypted ( <b>Privacy</b> )
<b>Read View</b>	A view to which the group has read access
<b>Write View</b>	A view to which the group has write access
<b>Notify View</b>	A view to which the group has notification privileges

To create a group and add its attributes to this tab, click **Create**, and use the Create SNMP Group window. See [Create SNMP Group, page 141](#).

To modify a group, select it, click **Modify**, and use the Modify SNMP Group window.

To delete a group, select it, and click **Delete**.

You cannot delete or modify the **v1default** group.

## Create SNMP Group

This window appears when you click **Create** on the Groups tab of the SNMP window. Use it to specify the attributes of a group of SNMP users.

To create an SNMP group, follow these steps.

---

**STEP 1** In the **Group Name** field, enter a name for the new group.

You can enter the name of a group that already exists, so long as you select a different security level. A group name and security level identify a group uniquely.

- 
- STEP 2** From the **Security Level** list, select a security level.
- NoAuthenticate means that packet authentication is not required.
  - Authenticate means packet authentication is required.
  - Privacy means that packet encryption is required. This option is enabled only if a cryptographic software image is installed.
- STEP 3** *Optional:* From the Read View list, select a view to which the group will have read access.
- STEP 4** *Optional:* From the Write View list, select a view to which the group will have write access.
- STEP 5** *Optional:* From the Notify View list, select a view to be sent to the group with notifications.
- STEP 6** Click **OK**. When you return to the SNMP window, you see a new entry on the Groups tab.
- 

## Modify SNMP Group

This window appears when you select a group and click **Modify** on the Groups tab of the SNMP window.

These are the attributes of the group that you can modify:

- The view of MIB objects to which the group has read access.
- The view of MIB objects to which the group has write access.
- The view of MIB objects that is sent to the group with notifications.

For more information on these window options, see the [Create SNMP Group](#) topic.

Click **OK** when you finish.

## Users

This table explains what each of the columns on this tab contains.

Column	Contents
<b>User</b>	The names of users
<b>Group</b>	The group to which the adjacent users belong
<b>Authentication Algorithm</b>	The type of algorithm that is used to encrypt the authentication password

To assign a user to a group and add the user to this tab, click **Create**, and use the Create SNMP User window. See [Create SNMP User, page 143](#).

To modify the attributes of a user, including the group that the user belongs to, select the entry for the user, click **Modify**, and use the Modify SNMP User window.

To delete a user, select the entry for the user, and click **Delete**.

## Create SNMP User

This window appears when you click **Create** on the Users tab of the SNMP window. Use it to specify the attributes of an SNMP user.

To create SNMP users, follow these steps.

- 
- STEP 1** In the **User Name** field, enter a name for the user.
  - STEP 2** From the **Group Name** list, select the group that the user belongs to. (The group must first be defined on the Groups tab.)
  - STEP 3** *Optional:* In the Authentication area, take these actions if the user will need an authentication password:
    - a. Select an authentication algorithm from the **Authentication Algorithm** list.
    - b. Enter a password in the **Password** field that the user will enter for authentication.
    - c. Enter the password again in the **Confirm Password** field.

- 
- STEP 4** Click **OK**. When you return to the SNMP window, you see a new entry on the Users tab.
- 

## Modify SNMP User

This window appears when you select a user and click **Modify** on the Users tab of the SNMP window.

These are the attributes of the user that you can modify:

- The group that the user belongs to, by selecting a different group name.
- The authentication algorithm, if any.
- The authentication password and confirm password, if any.

For more information on these window options, see the [Create SNMP User](#) topic.

Click **OK** when you finish.



# Port and Switch Settings

This section covers configuration of ports and switches. It includes these topics:

- **Switch Port Settings**
- **Smartports**
- **VLANs**
- **Port Mirroring (ESW500 Series Switches)**
- **Spanning Tree Protocol (CE520 Switches)**
- **IGMP Snooping (CE520 Switches)**
- **MAC Addresses (CE520 Switches)**
- **Port Search Window (CE520 Switches)**
- **EtherChannels (CE520 Switches)**

## Switch Port Settings

To configure switch port settings:

- Choose **Configure > Ports > Switch Port Settings** on the feature bar.
- Click the Switchports icon on the toolbar.

### Overview

By default, all ports on a switch are enabled, and port parameters are set with initial values. The Port Settings window displays these values and lets you change them.

Some port types automatically negotiate configuration settings. An auto-negotiation mismatch can occur under these conditions:

- When a manually set duplex parameter is different from that set on the attached port
- When a port is set to auto-negotiate and the attached port is set to full duplex with no auto-negotiation

The result of a mismatch on Fast Ethernet ports is reduced performance or link errors. On Gigabit Ethernet ports, the link does not come up, and no statistics are reported.

To correct mismatched port settings, do one of the following:

- Let both ports auto-negotiate both speed and duplex.
- Manually set the speed and duplex parameters for the ports on both ends of the connection.

To connect to a remote Fast Ethernet device that does not auto-negotiate, you should explicitly set the duplex on the local device to a value other than **Auto**. Speed negotiation works even if the other device does not auto-negotiate.

To connect to a remote Gigabit Ethernet device that does not auto-negotiate, disable auto-negotiation on the local device and set the duplex and flow control parameters to be compatible with the remote device.

### Procedures

Begin by selecting a device from the **Hostname** list. Information about the device ports is on these tabs:

- **Configuration Settings, page 147**, which displays values that you can set and modify.
- **Runtime Status, page 149**, which displays the actual status of the ports.

To see a subset of the information on either tab, click **Filter**, and use the Filter Editor window. See **Filter, page 152**.

**Configuration Settings**

This table explains the information on this tab.

Settings	Explanation
<b>Description</b>	<p>Text description of the port. Click <b>Describe</b> in the Port Settings window to describe multiple ports.</p> <p>You cannot use the ? and / characters.</p> <p>If you selected more than one port, this field is not available.</p>
<b>Status</b>	<p>Setting to enable or disable the port, which can be different from the runtime setting. For example, if no device is connected to a port, it can be administratively enabled with a runtime status of DOWN.</p> <p>If you change other settings on a disabled port, they do not take effect until you enable the port.</p> <p>When you disable a port, a <i>linkdown</i> trap is sent to the management station if you configured an SNMP manager.</p>
<b>Duplex</b>	<p>Setting for duplex: full duplex, half duplex, or auto. The default setting for Gigabit Ethernet and GigaStack GBIC ports is auto. These ports automatically match the duplex capability of an attached device.</p> <p>To set a duplex value other than auto, the speed value must be other than auto. The duplex value must be auto if the port speed is set to auto and if the port can run at a speed of 1000 Mbps.</p> <p>GigaStack GBIC stack connections operate in half-duplex mode.</p> <p>Point-to-point GigaStack GBIC port connections operate in full-duplex mode.</p>

Settings	Explanation
<b>Speed</b>	<p>Settings for the 10/100-Mbps and 10/100/1000-Mbps ports:</p> <ul style="list-style-type: none"> <li>▪ <i>10</i> (Ports run at a forced speed of 10 Mbps.)</li> <li>▪ <i>100</i> (Ports run at a forced speed of 100 Mbps.)</li> <li>▪ <i>1000</i> (Ports run at a forced speed of 1000 Mbps.)</li> <li>▪ <i>auto</i> (Ports auto-negotiate and advertise all available speeds.)</li> <li>▪ <i>auto 10</i> (Ports auto-negotiate and advertise a speed of 10 Mbps to the other end of the link.) Not available on ESW 500 Series switches.</li> <li>▪ <i>auto 100</i> (Ports auto-negotiate and advertise a speed of 100 Mbps to the other end of the link.) Not available on ESW 500 Series Switches.</li> <li>▪ <i>auto 100 1000</i> (Ports auto-negotiate and advertise speeds of 100 and 1000 Mbps to the other end of the link.)</li> <li>▪ <i>auto 10 1000</i> (Ports auto-negotiate and advertise speeds of 10 and 1000 Mbps to the other end of the link.)</li> <li>▪ <i>auto 1000</i> (Ports auto-negotiate and advertise a speed of 1000 Mbps to the other end of the link.)</li> <li>▪ <i>auto 10 100</i> (Ports auto-negotiate and advertise speeds of 10 and 100 Mbps to the other end of the link.)</li> <li>▪ <i>auto 10 100 1000</i> (Ports auto-negotiate and advertise speeds of 10, 100, and 1000 Mbps to the other end of the link.)</li> </ul> <p>The default setting for 10/100- and 10/100/1000-Mbps ports is <i>auto</i>. Ethernet ports can automatically match the transmission speed of an attached device.</p> <p><b>NOTE</b> You cannot modify the speed settings of these ports:</p> <ul style="list-style-type: none"> <li>▪ 1000BASE-T, SX, LX/LH, ZX, DWDM, and CWDM GBICs</li> <li>▪ 1000BASE-SX, LX/LH, ZX, and CWDM SFPs</li> <li>▪ XENPAK-10GB-LR, ER, CX4, SR, and LX4</li> <li>▪ 100BASE-FX</li> </ul>

Settings	Explanation
<b>Power</b>	This setting applies to a single port on a Catalyst Express 500 PoE or ESW500 Series switch. Select <b>auto</b> if you want the port to detect a power device and supply power to it. Otherwise, select <b>never</b> .
<b>Auto MDIX</b>	ESW500 Series switches only.  Displays the Media Dependent Interface (MDI)/Media Dependent Interface with Crossover (MDIX) status on an ESW500 switch port. Hubs and switches are deliberately wired opposite the way end stations are wired, so that when a hub or switch is connected to an end station, a straight through Ethernet cable can be used, and the pairs are matched up properly. When two hubs or switches are connected to each other, or two end stations are connected to each other, a crossover cable is used to ensure that the correct pairs are connected. Choose one of the following settings: <ul style="list-style-type: none"> <li>▪ <b>Auto.</b> Use to automatically detect the cable type. This is the default setting.</li> <li>▪ <b>MDIX.</b> Use for hubs and switches.</li> <li>▪ <b>MDI.</b> Use for end stations.</li> </ul>

To modify port settings one port at a time, click the corresponding cell for the port that you want to modify.

To modify the settings of one or more ports:

- 
- STEP 1** Select the ports in the Interface column. Hold down the **Ctrl** key and make your selections, or hold down the **Shift** key, and select the first and last port in a range.
- STEP 2** Click **Modify** to display the Modify Port Settings window. See [Modify Port Settings, page 151](#).
- STEP 3** Complete the fields in the Modify Port Settings window.
- STEP 4** Click **OK** to close the window and return to the Port Settings window.
- 

### Runtime Status

This table explains the read-only information on this tab.

Column	Explanation
<b>Interface</b>	Identifies the port: Fast Ethernet, Gigabit Ethernet, or FDDI, the module or slot number (0, 1, or 2), and the port number.
<b>Description</b>	The description of the interface.
<b>Ethernet Link</b>	The state of the port. The status of a port can be up, down, or administratively down.
<b>Duplex</b>	<p>The duplex state of the port (hybrid, half, full). Displays the port duplex mode.</p> <p>For ESW500 Series switches, Full indicates that the interface supports transmission between the device and the client in both directions simultaneously, and Half indicates that the interface supports transmission between the device and the client in only one direction at a time.</p>
<b>Speed</b>	<p>The speed of the port.</p> <p>For Gigabit Ethernet ports, this field is read-only and displays <i>1000</i> (1000 Mbps).</p>
<b>State</b>	Shows whether inline power is being supplied to a connected device.
<b>Budget</b>	Amount of power budgeted for the connected device.
<b>Device</b>	Shows the type of device that is receiving inline power from the interface.
<b>Class</b>	<p>The powered-device IEEE classification. Many powered devices do not require the full 15.4 watts of power available with PoE.</p> <p>The power classes range from 0 to 4. The default is 0. Power budgeted for the switch depends on the IEEE class.</p>

---

## Modify Port Settings

The Modify Port Settings window appears when you select multiple ports in the Switch Port Settings window.

Enter or select values for the ports to be modified. See [Configuration Settings, page 147](#) for descriptions of what to enter.

If you select multiple ports and specify a configuration setting that is not valid for a selected port, the current setting remains unchanged. For example, if you select a 10BaseT Ethernet, a Fast Ethernet, and a Gigabit port, and then select a speed of 100 Mbps, the 10BaseT Ethernet port remains set to 10 Mbps, and the Gigabit port remains set to 1000 Mbps.

Click **OK** to close the window. Your modifications appear in the Port Settings window.

For more information, see these topics:

- [Configuration Settings, page 147](#)
- [Runtime Status, page 149](#)

## Modify Port Descriptions

To add or modify port descriptions:

Select one or more ports. If you select one port, click the cell in the **Description** column for the port that you want to describe. Enter text at the blinking cursor.

If you select more than one port:

- 
- STEP 1** Click **Describe** to display the Basic Port Description window.
  - STEP 2** Complete the settings in the window. From the Basic Port Description window, you can go to the Advanced Port Description window to specify automatic increment for of up to three (3) descriptors.
  - STEP 3** Click **OK** to close the window.
-

## Filter

The Filter window appears when you click **Filter** in a Configuration Assistant window or wizard that contains a table. The column names in the table become the field names in this window. Enter selection criteria in the fields to filter out table rows and leave only those that interest you.

Follow these steps:

- 
- STEP 1** Leave a field blank if you do not want to filter its corresponding table column—that is, if you have no selection criteria for the column.
  - STEP 2** To use a field with a drop-down list, select an item for Configuration Assistant to match against entries in the corresponding column.
  - STEP 3** To use a text-entry field, enter characters for Configuration Assistant to match against entries in the corresponding column. Use a star (\*) as a placeholder for a character string of any length. Use a question mark (?) as a placeholder for any single character. To match a string regardless of the characters that precede or follow it, enter *\*string\**.

### Examples

- To see only the interfaces in the LRE Software Upgrade window that are enabled for an upgrade, select **enable** in the **Upgrade** field of the Filter Editor window that serves the LRE Software Upgrade window.
  - To see only the descriptions in the Port Settings window that contain the string 1234, enter **\*1234\*** in the **Description** field of the Filter Editor window that serves the Port Settings window.
- 
- STEP 4** Click **OK**. You return to the Configuration Assistant window or wizard that you were using and see the subset of information that you requested.

## Smartports

To configure port connections, you apply roles to the ports. To open the Smartports window and access these settings:

- Choose **Configure > Switching > Smartports** on the feature bar.
- Click the Smartports icon on the toolbar.



- Click **Resolve** in the Event Notification window to resolve a Smartports event.

### Overview

Smartports is a solution that helps you to configure the essential security, availability, and manageability features of your network port connections.

The Smartports window shows you the front panels of devices; you select ports and apply roles to them. You can configure a port connection to these devices:

Device	Comment
<b>Desktop</b>	An internal endhost with access to the Internet and to the internal subnets of an organization.
<b>IP phone</b>	An endhost such as PC can be cascaded to an IP phone.
<b>Switch</b>	A switch-to-switch connection.
<b>Router</b>	An access router or a UC 500 platform.
<b>Access point</b>	An access point can connect to mobile endhosts. Depending on the access-point setup, the mobile endhosts can be either guest or desktop endhosts.

### Procedures

The window shows a front-panel view of the devices in your network. If a port is connected to a device and a role has been applied to it, you see the icon for the connected device over the port. When you move your mouse pointer over the icon, Configuration Assistant identifies the type of device that is connected.

To apply roles to other connected ports or to correct a mistakenly applied role (shown by the Smartports conflict icon), take one of these actions:

- Click **Suggest**. The icons of the connected devices blink over the ports, and the Suggested Smartports window appears. It suggests the roles to apply to the ports. See [Suggested Smartports, page 156](#).
- Select a port, and click **Modify**. The Modify Port Roles window appears. You can also use this window to remove Smartports roles or to apply Smartports roles to ports that do not have device connections. See [Modify Port Roles, page 154](#).

**Notes:**

- To select multiple ports, hold down the **CTRL** key, and click the ports that you want. You can also *rubberband* ports by holding down a mouse button and drawing a rectangle around a group of ports. Hold down the **CTRL** key to rubberband disjointed groups of ports.
- When you use CCA to apply a role, it replaces previously applied roles.

When you return to the Smartports window, you see device icons on top of the ports for which you made role selections. If you asked CCA to remove roles, the icons that were previously shown are gone.

To see details about configured ports, click **Details** to open the Port Roles Details window. See [Suggested Smartports, page 156](#).

For more information, see these topics:

- [Modify Port Roles, page 154](#)
- [Port Roles Details, page 156](#)
- [Suggested Smartports, page 156](#)

## Modify Port Roles

This window appears when you select one or more ports on the Port Setup tab of the Smartports window and click **Modify**. If you selected one port, the **Interface** field shows the port name. If you selected more than one, the **Interface** field shows **Multiple**.

To apply a role to the selected ports, follow these steps:

From the **Role** list, select a role that corresponds to the device that you want to connect to.

Device	Comment
<b>Desktop</b>	An internal endhost with access to the Internet and to the internal subnets of an organization.
<b>IP Phone + Desktop</b>	An endhost such as PC can be cascaded to an IP phone.
<b>Switch</b>	A switch-to-switch connection.

Device	Comment
<b>Router</b>	An access router or a UC500 platform.
<b>Access point</b>	An access point can connect to mobile endhosts. Depending on the access-point setup, the mobile endhosts can be either guest or desktop endhosts.

If you selected a 10-Gigabit Ethernet port, only the **Switch** and **Router** choices are available.

Complete the **Attributes** section according to the role that you selected.

If you selected...	Follow these steps...
<b>Desktop</b>	Enter the number of a VLAN in the <b>Access VLAN</b> field. This is the VLAN that will send data between the port and the desktop.
<b>IP Phone+Desktop</b>	<ul style="list-style-type: none"> <li>▪ In the <b>Access VLAN</b> field, choose the data VLAN (usually VLAN1). This is the VLAN that will send data packets to and from the port.</li> <li>▪ In the <b>Voice VLAN</b> field, choose the Voice VLAN (usually cisco-voice). This is the VLAN that will send voice packets to and from the port.</li> </ul>
<b>Router or Access Point</b>	Enter the number of the native VLAN in the <b>Native VLAN</b> field. The port will be configured as a trunk port and the native VLAN will send untagged traffic.
<b>Switch</b>	<p>Enter the number of the native VLAN in the <b>Native VLAN</b> field. The port will be configured as a trunk port, and the native VLAN will send untagged traffic.</p> <p>Check the <b>Allow Internal VLANs Only</b> check box to allow all traffic for all the VLANs except the Guest and DMZ VLANs. If the checkbox is unchecked, traffic for all VLANs is allowed. If no DMZ or Guest VLAN is configured, this checkbox is disabled. You must configure a Guest or DMZ VLAN to enable this checkbox.</p>

To remove a role from the selected ports, choose **none** from the **Role** list. The port is reset to its factory defaults.

Click **OK** when you finish with the window. The Smartports window returns.

## Port Roles Details

This window appears when you click **Details** on the Port Setup tab of the Smartports window.

If you select ports before clicking **Details**, you see expanded headings for the devices with the selected ports. If you do not select any ports, you see expanded headings for all the devices in the Smartports window.

Under the device headings are expanded port headings, and under these are the role details. If a role is applied to a port, you see the role type and related configuration information. If no role is applied, you see none.

Click **OK** when you finish with the window.

## Suggested Smartports

This window appears when you take either of these actions:

- Click **Suggest** in the Smartports window.
- Click **Resolve** in the Event Notification window to apply a Smartports role.

Use the window to:

- Configure VLANs for suggested port roles for IP phones, switches, routers, or access points.
- Correct mistakenly applied roles.

To apply a role to a port:

---

### STEP 1 Accept the role in the Role Suggested column.

Notes:

- Sometimes Configuration Assistant detects the connected device type as a switch when the real device type is a router, and the reverse. Modify the port role if the suggested device type is incorrect.

- If the connected device is an access point, you can accept the suggested **Access Point** role or modify the port role.
- Configuration Assistant cannot detect a switch or a sniffer that is connected to a Cisco Express 500 switch port. Therefore, you will see no suggested roles for these connections.

**STEP 2** Select a VLAN (two VLANs for IP phones). This table shows what VLAN selections are needed for each type of device connection.

For connections to	You select
An IP phone + desktop	An access VLAN and a voice VLAN
Desktop	An access VLAN
A switch	The native VLAN
A router	The native VLAN
An access point	The native VLAN

The VLANs that you select must correspond to the connections that you are configuring. If you need a VLAN that is not listed, it does not exist. Close this window and the Smartports window, use the VLANs window to create the VLAN, and then use the Smartports feature again.

**STEP 3** Click **OK** when you finish.

**STEP 4** In the Smartports window, click **OK** to apply the roles for which you configured VLANs.

## VLANs

This window appears when you choose **Configure > Switching > VLANs** on the feature bar.

When you select a device from the **Hostname** list, you see the following information for each VLAN:

- VLAN ID

- VLAN name
- IP address, subnet, and subnet mask
- Default Voice VLAN (indicated by a Green checkmark)

If VLAN-synchronized devices such as a UC500, ESW500 Series switches, and Catalyst Express CE520 switches are part of the customer site, the **Hostname** device selector displays the value **All UC5xx/CE/ESW**.

See the following sections for more information about VLANs and VLAN settings:

- [Overview](#)
- [Notes](#)
- [Procedures](#)

### Overview

You can create VLANs for the following devices:

- All UC500 devices
- All SR500 devices
- All C8xx devices

A VLAN (Virtual LAN) is a switched network that is logically segmented by function, project team, or application, without regard to the physical locations of the users. VLANs have the same attributes as physical LANs, but you can group end stations even if they are not physically located on the same LAN segment. Any switch port can belong to a VLAN, and unicast, broadcast, and multicast packets are forwarded and flooded only to the end stations in the VLAN.

VLANs define broadcast domains in a Layer 2 network. A broadcast domain is the set of all devices that receive broadcast frames originating from any device within the set. Broadcast domains are typically bounded by routers because routers do not forward broadcast frames. Layer 2 switches create broadcast domains based on the configuration of the switch. Switches are multiport bridges that allow you to create multiple broadcast domains. Each broadcast domain is like a distinct virtual bridge within a switch.

You can define one or many virtual bridges within a switch. Each virtual bridge that you create in the switch defines a new broadcast domain (VLAN). Traffic cannot pass directly to another VLAN (between broadcast domains) within the switch or between two switches. To interconnect two different VLANs, you must use routers or Layer 3 switches.

By default, switches are configured with a single VLAN, VLAN 1. If you want to create additional VLANs, you can do this from the VLAN window. You can also use this window to change the name of a VLAN or to remove it.

When you create, modify, or delete a VLAN on a switch or a Unified Communications 500 Series platform, your action is automatically duplicated on all the devices of these types in your customer site. The duplication preserves VLAN consistency among the devices. If you add a device to the site that already has a VLAN associated with it, a VLAN conflict occurs with the devices that do not have this VLAN association. When this happens, you are prompted to use the VLAN Synchronization Window to restore VLAN consistency. See [VLAN Synchronization, page 161](#).

### Notes

The following notes apply to VLAN creation and modification:

- Up to 15 VLANs can be associated with a device. All devices are associated by default with VLAN 1.
- Only the VLAN Name and VLAN ID are synchronized to ESW500 and CE520 switches.
- In a multisite deployment, VLANs can only be configured on the local UC500. VLAN changes made on the local UC500 are not applied to other UC500s in the multisite deployment, and only local devices are synchronized.

### Procedures

To create a VLAN, select a **Hostname**, click **Create**, and complete the settings in the Create VLAN window. See [Create VLAN, page 160](#).

To change the name, IP address, subnet, or subnet mask of a VLAN, select the VLAN in this window, and click **Modify**. See [VLAN Synchronization, page 161](#). VLAN 1 is reserved by CCA, so you cannot modify its name or VLAN ID.

To remove a VLAN, select it, and click **Delete**.

When you are finished making changes, click **OK** or **Apply**.

For more information, see these topics:

- [Create VLAN, page 160](#)
- [VLAN Synchronization, page 161](#)

## Create VLAN

This window appears when you click **Create** in the VLAN window (**Configure > Switching > VLANs**).

To create a VLAN, complete the fields in the Create VLAN window as described below, then click **OK**.

After the new VLAN is created, you can choose **Configure > Routing > DHCP Server** to create DHCP pool, DHCP exclusion ranges, and DHCP bindings, if needed.



Setting	Description
<b>VLAN ID</b>	Enter the ID of the VLAN. Use an ID in the range 2 to 1000. Do not enter 1; this ID is reserved for the default Data VLAN.
<b>VLAN Name</b>	<p>The default name is VLANxxxx, where xxxx represents four digits (including leading zeros) equal to the VLAN ID number. You can use this value or enter a VLAN name from 1 to 32 characters.</p> <p>The VLAN name must be unique.</p> <p>The default Voice VLAN must be named Cisco-Voice. The VLAN name Cisco-Voice is reserved by CCA.</p>
<b>Make Default Voice VLAN</b>	<p>When this option is checked, this VLAN is used for the default Voice VLAN.</p> <p>The default Voice VLAN is VLAN100.</p>
<b>IP Address</b>	<p>Enter the IP address for this VLAN.</p> <p>If the IP address for the default Data or Voice VLAN is modified, its corresponding firewall, NAT and DHCP pools are also modified.</p> <p>The IP address cannot be a duplicate of or overlap with other existing interface IP addresses.</p>
<b>Subnet</b>	Enter the subnet for this VLAN.
<b>Subnet Mask</b>	Enter the subnet mask for this VLAN or choose one from the drop-down list.

## VLAN Synchronization

The devices in your community must have the same VLANs configured on them. If they do not, CCA displays an event icon on the status bar and records the conflict in the Event Notification window. When you acknowledge the event in that window and click **Resolve**, the VLAN Synchronization window appears. In this window, you resolve the VLAN conflicts.

This table explains the columns in the window.

Column	Explanation
<b>VLAN ID</b>	The IDs of the VLANs that have a conflict.
<b>Conflict</b>	A description of the conflict: <ul style="list-style-type: none"> <li>Does not exist: The VLAN is not configured on all devices.</li> <li>Exists with different name: The VLAN IDs match on all devices, but the VLAN names do not match on all devices.</li> </ul>
<b>Resolution Action</b>	A drop-down list of actions that will resolve the conflict. You choose the action that best suits your needs.

When you have chosen actions for each VLAN conflict, click **Resolve**. You see that your actions are reflected in the open VLAN window.

You cannot click **Resolve** until you chose an action for each VLAN conflict.

Click **Apply** in the VLAN window to save the actions and do other tasks there, or click **OK** to save them and close the window.

## Port Mirroring (ESW500 Series Switches)

To configure port mirroring on Cisco ESW500 Series switches, choose **Configure > Ports > Port Mirroring** from the feature bar.

### Overview

Port Mirroring monitors and mirrors network traffic by forwarding copies of incoming and outgoing packets from one port to a monitoring port. Port Mirroring can be used as a diagnostic tool and/or a debugging feature. It also enables switch performance monitoring.

Network administrators configure Port Mirroring by selecting a destination port to copy all packets, and up to 8 different source ports from which the packets are copied.

### Important Guidelines

- Before you can configure port mirroring on ESW500 Series switches, the Smartport role for the Destination Port must be set to **Other**.

- Do not use switch ports or uplink ports for port mirroring.
- You cannot use the same port as both a destination and a source port.
- Source and destination ports must reside on the same switch.

### Procedures

To configure Port Mirroring, configure settings as described below, then click OK.

Setting	Description
<b>Destination Port</b>	Defines the port to which the source port traffic is mirrored.
<b>Source Port</b>	Defines the port from which traffic is to be analyzed. Up to 8 ports can be selected as source ports.
<b>Type</b>	Indicates the port mode configuration for port mirroring. The possible field values are: <ul style="list-style-type: none"> <li>▪ <b>Receive Only.</b> Defines port mirroring for receive traffic only on the selected port.</li> <li>▪ <b>Transmit Only.</b> Defines port mirroring for transmitting ports. This is the default value.</li> <li>▪ <b>Transmit and Receive.</b> Defines port mirroring on both receiving and transmitting ports.</li> </ul>

## Spanning Tree Protocol (CE520 Switches)

To configure Spanning Tree Protocol (STP) for CE520 Switches, choose **Configure > Switching > STP**.

### Overview

Spanning Tree Protocol (STP) is a standardized technique for maintaining a network of multiple bridges or switches. When the network topology changes, STP prevents the creation of loops by placing ports in a forwarding or blocking state and transparently re-configures bridges and switches. Each VLAN is treated as a separate network, and a separate instance of STP is applied to each.

This switch supports the per-VLAN spanning-tree (PVST+) protocol, based on the IEEE 802.1D standard and Cisco proprietary extensions.

STP parameters are set for each VLAN. For each spanning-tree instance, you can configure a set of global options and a set of port parameters. The switch supports up to 32 spanning-tree instances.

You can configure STP in these ways:

- Change the STP status to **disable** (or **enable**) on one more VLANs.
- Change spanning-tree parameters for the root switch.

### Procedures

The STP window has these tabs:

- **STP Status**, to disable (or enable) Spanning Tree Protocol (STP) on one or more VLANs
- **Current Roots**, to view the current spanning tree root settings

Begin by selecting a switch from the **Hostname** list. The information on the tabs applies to the selected switch.

To see a subset of the port information on the tabs, click **Filter**, and use the Filter Editor window (see [Filter, page 152](#)). Click **Refresh** to poll the device and to display the most current data.

When you finish configuring STP, click **OK**.

### STP Status

This tab shows whether STP is enabled for each VLAN on the switch. STP is enabled by default. However, by disabling STP, you can avoid the 30-second delay in packet forwarding from a port when a switch re-configures.

This switch supports only the per-VLAN spanning-tree plus (PVST+) protocol, which is represented by **pvst** in the **Spanning-Tree Mode** list.

**IMPORTANT** Disable STP only if you are sure there are no loops in your network topology. If STP is disabled and loops are present in the topology, network performance is degraded by excessive traffic and indefinite packet duplication.

To disable or enable STP:

- 
- STEP 1** In the **VLAN ID** column, select one or more VLANs on which you want to disable or enable STP.
  - STEP 2** In the **Spanning-Tree Status** column, select **enable** from the drop-down list to enable STP for each VLAN that you selected.

Select **disable** to disable STP for each VLAN that you selected.

### Current Roots

For each VLAN, the **Current Root** tab (a read-only tab) displays the STP settings on the current port switch. These settings, which could be defined on another switch, define the parameters that take effect when the switch is acting as the VLAN root.

These settings are described in the table below.

Field	Description
<b>VLAN ID</b>	The VLAN to which these settings apply when the switch acts as the root.
<b>MAC Address</b>	The MAC address of the root switch.
<b>Priority</b>	Identifies the root bridge. The switch with the lowest value has the highest priority and is selected as the root. The default is 32768.
<b>Max Age</b>	Sets the number of seconds that a switch waits without receiving STP configuration messages before it attempts a re-configuration. The default for IEEE is 20 seconds; the default for IBM is 10 seconds.
<b>Hello Time</b>	Sets the number of seconds between STP configuration messages. For IEEE and IBM, enter a number from 1 to 10. The default is 2 seconds.
<b>Forward Delay</b>	Sets the number of seconds that a port waits before changing from its STP learning and listening states to the forwarding state. This delay time ensures that no loop is formed before the switch forwards a packet. The default for IEEE is 15 seconds; the default for IBM is 4 seconds.
<b>Root Path Cost</b>	A relative measure used to determine the most favorable path to a destination. See the <a href="#">Path Cost Table, page 166</a> for details.
<b>Root Port</b>	The port to which these settings apply.

Field	Description
<b>Root Bridge</b>	<p>If the switch is actually the root of STP for that VLAN, the field displays <b>Yes</b>. Otherwise, the field displays <b>No</b>, and the root port of the device is listed in the Root Port column.</p> <p><b>NOTE</b> Each switch in a spanning-tree instance adopts the hello, delay, and max age parameters of the root bridge, regardless of how it is configured.</p>

### Path Cost Table

This table explains default path-cost settings for different speeds.

Path Cost	Speed
<b>100</b>	10 Mbps
<b>19</b>	100 Mbps
<b>14</b>	155 Mbps
<b>4</b>	1 Gbps
<b>2</b>	10 Gbps
<b>1</b>	Speeds greater than 10 Gbps

## IGMP Snooping (CE520 Switches)

To enable and disable IGMP snooping and perform related configuration tasks on Cisco CE520 switches, choose **Configure > Switching > IGMP Snooping** from the feature bar.

### Overview

Switches can reduce the unnecessary flooding of IP multicast packets by limiting the transmission of these packets to groups of clients that request them. When clients (end stations) automatically join and leave groups that receive IP multicast traffic, your switches can dynamically change their forwarding behavior according to join and leave requests. Internet Group Management Protocol (IGMP) snooping gives switches this control.

## Procedures

The IGMP Snooping window has these settings:

- Settings to enable IGMP snooping generally and on individual VLANs
- Multicast Groups to view the multicast groups
- Multicast Router Port, to view the multicast router ports

Before you make selections on the Setting tab, select a device from the Hostnames list. All the choices that you make on this tab will apply to the selected device.

Follow these steps to change the settings:

- 
- STEP 1** Enable IGMP Snooping is checked by default. Uncheck it only if you want to disable IGMP snooping on the entire device.
- STEP 2** The table shows the VLANs that switch ports belong to and the settings for the VLANs. By default, IGMP snooping is enabled on the VLANs. To change any of these defaults, click **Modify**, and use the Modify IGMP Snooping Settings window. See [Modify IGMP Snooping, page 167](#).
- STEP 3** When you return to the IGMP Snooping window, click **OK**.

The information shown in the Multicast Groups tab and Multicast Router Ports tab is read-only and cannot be modified.

---

## Modify IGMP Snooping

This window appears when you select a VLAN and click **Modify** on the IGMP Snooping window while viewing its Settings tab. Use this window to enable or disable IGMP snooping on the selected VLAN.

Follow these steps:

- 
- STEP 1** Select either **Enable** or **Disable** from the Status list.
- STEP 2** When you have made your changes, click **OK** to close the window and return to the IGMP Snooping window.
-

## MAC Addresses (CE520 Switches)

Switches store the Media Access Control (MAC) addresses of attached devices in a MAC addresses table. You can manage the addresses in this table by choosing **Configure > Switching > MAC Addresses** from the feature bar.

### Overview

A switch learns the MAC addresses of attached devices, VLAN IDs, and interface numbers by reading the source address of arriving packets. After an entry is removed, the switch relearns it. If the switch encounters a packet for an unknown destination, it floods the packet to all ports of the VLAN.

As stations are added or removed from the network, the switch updates the table, adding new entries and aging those not in use. The switch also updates the table by deleting all addresses associated with a port on which a VLAN membership change occurred.

A switch can learn an address in more than one VLAN, and an address that it learns in one VLAN can be entered as a secure address in another VLAN. An address that the switch learns in one VLAN is unknown in another VLAN until the address is learned.

### Procedures

To view or update the MAC address table, follow these steps.

- STEP 1** From that Hostname list, select the switch whose stored MAC addresses you want to see.

The table columns have these meanings.

Column	Meaning
<b>MAC Address</b>	The MAC address of an attached device.
<b>VLAN ID</b>	The VLAN ID that is configured on the sending interface.
<b>Output Interface</b>	The interface to which received packets should be forwarded if the MAC address of the sender matches the one in the MAC Address column.

- STEP 2** *Optional.* To delete the addresses and clear the table, click **Remove All**.



---

**STEP 3** Click **OK** to close the window.

---

## Port Search Window (CE520 Switches)

To access the Port Search window, choose **Monitor > Search** from the feature bar. This option is only available if a Cisco CE520 switch is present in the customer site.

### Overview

You can search for ports or devices in your network. Perhaps you want to know the type, status, and speed of a port, but you do not know its number or what device it is on. You can find the information quickly if you know something about the text description that was entered for the port. You can also search for devices that are connected to a specific device if you know the MAC address or IP address of that specific device. To search ports or devices, choose, and enter a search phrase, IP address, or MAC address in the Search window.

When you have the port search results, use them to browse the Port Settings window, which gives you configuration settings and run-time status information. When you have the device search results, use them to browse the Topology view, which helps you locate the connected devices.

### Procedures

From this window, you can search for ports that have a descriptive word or phrase associated with them. You can also search for devices that are connected to a specific device by entering the IP address or MAC address of the specified device.

Follow these steps:

---

**STEP 1** In the **Find Ports With Description/IP Address/MAC Address** field, enter a descriptive word or phrase, a MAC address, or an IP address. What you enter is matched against all the devices in the community or cluster.

Enter the MAC address in the format `xxxx.xxxx.xxxx.xxxx` or `xx:xx:xx:xx:xx:xx`, where x is a hexadecimal character (0-9, a-f, A-F).

**STEP 2** Click **Search**.

If you entered a port description in the Search field, ports that match the description appear in the Search Results area. This information appears in a table.

Column	Explanation
<b>Ports</b>	Device name and port number of the ports that match the description.
<b>Description</b>	Description of the port.

If you click **Search** with no text in the search field, Configuration Assistant shows you a list of all the community members, excluding WLAN controllers, and their ports.

If you entered an IP address or MAC address in the **Search** field, this information appears in a table:

Column	Explanation
<b>Host</b>	Name of the device whose IP address or MAC address was entered in the search field.
<b>MAC Address</b>	MAC address of the device.
<b>IP Address</b>	IP address of the device.
<b>Description</b>	Type of device.

**STEP 3** Click **OK** when you are done with this window.

## EtherChannels (CE520 Switches)

To view or configure port groups on CE520 switches, choose **Configure > Ports > EtherChannels** from the feature bar.

### Overview

Fast EtherChannel and Gigabit EtherChannel port groups are logical high-speed connections between switches or between switches and servers. Port groups can also provide redundant links between switches. The switch treats the port group as a single logical port; therefore, when you create a port group, the switch uses the configuration of the first port for all ports added to the group. After the group is created, changing STP or VLAN membership parameters for one port in the group automatically changes the parameters for all ports.

One port in each group carries all unknown multicast, broadcast, and STP packets.

The EtherChannels window displays port groups and enables you to:

- Create Fast EtherChannel and Gigabit EtherChannel port groups
- Remove ports from a port group
- Change the forwarding method for a group

### Procedures

This window appears when you choose on the feature bar. You can also click here to launch it. Use it to display EtherChannel port groups and to:

- [Create Port Groups](#)
- [Modify Port Groups](#)
- [Delete Port Groups](#)

Begin by selecting a local device from the Hostname list. The information in the Channel Groups area applies to the selected device.

The Load Balance field is set to Source-Destination IP Address by default. This field cannot be modified.

Your choice applies to every port group that you create on the switch.

This table explains the columns in the Channel Groups area.

Column	Explanation
Group	The number assigned to the port group.
Ports	The ports that belong to the group.
Status	Either Down or In use. You also see that the group contains Layer 2 interfaces.

### Create Port Groups

You can create up to 6 port groups. The ports that form a group must be of the same type.

Review [Port Group Restrictions, page 173](#) before you use this procedure.

A port group can both contain up to 16 members if they are in LACP mode. Otherwise, it can contain up to 8 members.

By default, a switch forwards traffic to a port group based on the packet source address. If you configure a static address for a port group, configure the switch to forward packets from the static address to all ports in the group to eliminate the chance of lost packets. If you set the port group to forward packets based on the destination address, configure the switch to forward packets destined for the static address to only one port in the port group. Otherwise, the destination address receives duplicate packets.

To create a port group:

---

**STEP 1** Click **Create**, and use the Create EtherChannel window. See [Create Port Groups, page 174](#).

You can create a port group on the local device that you selected and, optionally, on a remote device.

Click **OK** to put your changes into effect and to close the window.

**STEP 2** Click **OK** to close the EtherChannels window.

---

---

### Modify Port Groups

You can modify a port group by:

- Adding a member port
- Removing a member port
- Changing the LACP mode of a member port

To perform any of these tasks, follow these steps.

- 
- STEP 1** In the Channel Groups area, select the row for the group that you want to modify.
- STEP 2** Click **Modify**, and use the Modify EtherChannel window. See [Create Port Groups, page 174](#).
- You can modify a port group on the local device that you selected and, optionally, on a remote device.
- STEP 3** Click **OK** to put your changes into effect and to close the window.
- STEP 4** Click **OK** to close the EtherChannels window.
- 

### Delete Port Groups

To delete a port group, follow these steps.

- 
- STEP 1** In the Channel Groups area, select the row for the group that you want to delete.
- STEP 2** Click **Delete**.
- STEP 3** Click **OK** to close the window.
- 

### Port Group Restrictions

Any port can belong to a port group, but these restrictions apply:

- The Switch role must be applied to the port group member.
- No port group member can be configured for port monitoring.
- No port group member can be enabled for port security.
- Port group members must belong to the same set of VLANs and must be all static-access, all multi-VLAN, or all trunk ports.

- Dynamic-access ports cannot be grouped with any other port, not even with other dynamic-access ports.
- A network port cannot be in a destination-based port group.

## Create Port Groups

This window appears when you click Create in the EtherChannels window. Use it to assign local ports to a port group on the selected device, and optionally, to assign remote ports to a port group on a remote device.

Only ports that are assigned the switch port role appear in this window.

Follow these steps:

- 
- STEP 1** If you are creating port groups on a local and a remote device, select the remote device from the Remote Device list. Under the Remote Ports side of the window, you see the remote ports that are connected to the ports of the local device.
- Notice that the options for the remote device are the same as for the local device. When you select options for the local device, do the same for the remote device.
- STEP 2** In the **Group** field, enter the number of the port group that you are creating.
- STEP 3** Check the box under In Group for each port that you want to be a group member.
- STEP 4** Bypass the Status column. It shows the status of the ports only in the Modify EtherChannel window.
- STEP 5** Click in the Mode cells for the selected ports, and select one of these values:
- **LACP.** The port can form a link aggregate and initiate the channel. The aggregate is formed if the other end is running LACP in active mode.
  - **On (No LACP).** The port does not use LACP. A usable EtherChannel only exists if the port group is connected to another group in this mode.
- STEP 6** Click in the Priority cells for the selected ports, and enter a LACP priority if you do not want the default (32768 for LACP).

The port with the highest priority sends the packets.

- STEP 7** Click **OK** to close the window.

The new port group appears in the EtherChannels window.

---

## Modify Port Group

This window appears when you select a port group and click Modify in the EtherChannels window.

These are the options of a local and remote port group that you can modify:

- The ports that belong to a port group
- The mode of a port
- The priority of a port

The Status column displays information about the ports that might help you decide whether to make modifications. These statuses can be displayed:

Status	Meaning
<b>in port-group</b>	The port is working in the port group.
<b>hot-standby</b>	A maximum of 8 LACP ports are already active.
<b>suspended</b>	The port is temporarily not working, perhaps due to an inconsistency with other ports.
<b>standalone</b>	The port is connected to a remote port that is not participating in a port group.
<b>down</b>	The port is not working. It might be unconnected or administratively down.

**STEP 8** Click **OK** when you finish.





# Routing and Network Connections

This section covers network routing configuration and includes these topics:

- [IP Addresses](#)
- [Internet Connection](#)
- [DHCP Server](#)
- [Static Routing](#)

## IP Addresses

To manage IP addresses, choose **Configure > Routing > IP Addresses** from the feature bar. See these topics for information about enabling and configuring IP addresses:

- [Overview](#)
- [Modifying Default VLANs](#)
- [Interface Configuration](#)
- [Device Configuration](#)



---

**CAUTION** We do not recommend that you configure IP addressing over a remote WAN connection. If the connection to the WAN is interrupted, the operation will fail and the system may become unusable.

---

## Overview

The IP Addresses window has these tabs

- **Interface Configuration**, to assign or modify an IP address and subnet mask for a VLAN. When you do this, the VLAN becomes a Switched Virtual Interface (SVI). Creating an SVI does not enable routing on the device.
- **Device Configuration**, to associate a domain name with the selected device

## Modifying Default VLANs

Default VLANs are part of the factory configuration for these devices:

- For the UC500, these default VLANs are created:
  - **VLAN 1**: Default data VLAN for the UC500.
  - **VLAN 100**: Default voice VLAN for the UC500.
  - **BV175**: UC500 wireless data VLAN.
- For the SR520, the default data VLAN is **VLAN75**.
- For the SR520-T1, the default data VLANs are **LAN0** (FastEthernet0) and **LAN1** (FastEthernet1)

You can modify the IP address and subnet mask for these default VLANs on the **Interface Configuration** tab in the IP Addresses window.

The default data and voice VLAN configuration for the UC500 can also be modified through the Telephony Setup wizard, which must be run on a system that is at factory default state or through the Multisite Manager.



**CAUTION** Modifying IP address of the default data and voice VLANs after initial system configuration results in changes to other system configuration settings. After you change this configuration, verify that the system functions as expected.

Do not modify these settings over a remote WAN connection.

Editing the Network field for the VLAN100 or VLAN1 interface on the DHCP Pools tab in the DHCP Server window (**Configure > Routing > DHCP Server**), will have the same effect as changing the IP address of the data and/or voice VLAN on the device.

**IMPORTANT:**

- After changing the default data VLAN IP address, you must manually adjust any custom NAT port mappings rules defined under **Configure > Security > NAT**.
- After changing the default data VLAN IP address on the UC500, you must restart any ESW500 Series switches in the customer site in order to renew the DHCP lease on the ESW500. This issue could also apply to other devices in the site.

The following table describes configuration settings that are automatically updated by CCA when you the IP address of each of these default VLANs for these devices.

Device	Default VLAN	Settings that are updated when this VLAN is modified
UC500	Data VLAN (VLAN1)	<p>The IP address of the data VLAN (VLAN1 / BVI1) is set to the new value.</p> <p>The existing DHCP address exclusion range is removed and a new DHCP address exclusion range is added, based on the new data VLAN IP.</p> <p>The existing VPN IP address pool is removed, and a new VPN IP address pool is added, based on the new data VLAN IP address.</p> <p>Dial peers that use session target to point to the route for the existing data VLAN IP address are modified to point to the new one. For example, if the new data VLAN IP address is 192.168.20.1, the dial peer uses session target ipv4:192.168.20.1.</p> <p>All ACLs (access control lists) are modified to use the new data VLAN IP address.</p> <p>If the UC500 is behind an SR500:</p> <ul style="list-style-type: none"> <li>▪ All ACLs that refer to the existing subnet are modified to refer to the new one.</li> <li>▪ Static routes from the SR500 to the UC500 that refer to the existing data VLAN IP address are modified to use the new data VLAN IP address.</li> </ul> <p>If the UC500 is behind an SA500 security appliance and the SA500 has static routes to the existing data VLAN on the UC500, these are modified to point to the new data VLAN.</p>

Device	Default VLAN	Settings that are updated when this VLAN is modified
<b>UC500</b>	Voice VLAN (VLAN100)	<p>The UC-500 wireless data VLAN is modified (VLAN75/ BVI75) to use the new value.</p> <p>SCCP control application settings are modified to refer to the new voice VLAN IP address.</p> <p>ACLs on the UC500 that refer to the existing voice VLAN IP address are modified to refer to the new one.</p> <p>If the UC500 is behind an SR500 or SA500, ACLs on the SR500 or SA500 that refer to the existing voice VLAN IP address are modified to refer to the new one.</p>
<b>SR500 and SR520-T1</b>	Data VLAN VLAN75 for the SR500  FastEthernet0/0, FastEthernet0/1 for the SR520-T1)	<p>The IP address of the data VLAN (VLAN75) is set to the new value.</p> <p>The existing DHCP address exclusion range is removed and a new DHCP address exclusion range is added, based on the new data VLAN IP.</p> <p>The existing VPN IP address pool is removed, and a new VPN IP address pool is added, based on the new data VLAN IP address.</p> <p>All ACLs (access control lists) are modified to use the new data VLAN IP address.</p> <p>If a UC500 is behind the SR500:</p> <ul style="list-style-type: none"> <li>▪ All ACLs that refer to the existing data VLAN IP address are modified to refer to the new subnet.</li> <li>▪ Static routes on the UC500 that refer to the data VLAN IP address of the SR500 modified to use the new data VLAN IP address.</li> </ul> <p>Network Address Translation (NAT) rules on the SR500 for forwarding traffic on ports 5060 (SIP) and 1720 (H323) are modified to use the new data LAN IP address.</p> <p>Default routes for the UC500, if it is connected to an SR500 and connected to a customer site, are also adjusted to reflect the new value.</p>

## Interface Configuration

Begin by selecting a device from the Hostname list.

In the **Interface Name** column, you see the names of the VLANs that are configured on the selected device. These can be default VLANs that are part of the factory default settings for a device or VLANs that you added.

- To assign a new IP address, click in the IP address column for the selected device, and enter the new IP address.
- To assign a new subnet mask, click the Subnet Mask column for the selected device, and enter a new value.

Click **OK** or **Apply** when you are finished.

If you are connected to the default data VLAN on the UC500 or SR500, you will lose the connection to the UC500 when data VLAN IP address for the UC500 or SR500 data VLAN is modified. Close CCA, then re-launch CCA and connect to the device or site using the new IP address.

## Device Configuration

- 
- STEP 1** Begin by selecting a device from the Hostname list.
- STEP 2** In the **Domain Name** field, enter a name that identifies an administrative region in the IP network. You might need to ask your network administrator for this information. When network traffic contains no domain name, the name that you enter is appended to the name of the device, and the fully qualified name is added to the devices hostname table.
- STEP 3** Check **Enable Domain Lookup** to enable servers to translate device names to IP addresses.
- STEP 4** In the **New Server** field, enter the name of a device that you want to use as a DNS server (domain name server), and then click **Add**. The device is added to the Current Servers list.
- STEP 5** To stop using a device as a DNS server, select it in the **Current Servers** list, and click **Remove**.
- STEP 6** Click **OK** or **Apply**.
-

---

## Internet Connection

The Internet Connection Window appears when you choose **Configure > Routing > Internet Connection** from the feature bar.

### Overview

The Internet Connection window has two tabs:

- **Connection Settings:** For enabling and configuring the Internet WAN connection and configuring optional DDNS (Dynamic Domain Name Service) settings.
- **Traffic Shaping:** For enabling traffic shaping and configuring Quality of Service (QoS) settings (recommended for multisite deployments).

### Connection Settings

From this tab, you enable and configure the Internet connection. These connection types are supported:

- **PPPoE or PPPoE with a negotiated IP address:** PPPoE can be used by multiple hosts on a shared Ethernet interface to open PPP sessions to multiple destinations with one or more bridging modems. If you choose a negotiated IP address, the router obtains an IP address through PPP/IPCP (Point-to-Point Protocol/IP Control Protocol) address negotiation.
- **Static IP address:** Configure the interface to use a static IP address.
- **DHCP:** Configure the interface to obtain an IP address from a DHCP server.

You can also configure optional settings for Dynamic DDNS.

To enable and configure the Internet connection, follow these steps.

- 
- STEP 1** Choose a device to be configured from the Hostname list.
  - STEP 2** Choose an interface from the WAN Interfaces list.
  - STEP 3** Click **Modify** to open the Modify Internet Connection window. See **Modify Internet Connection, page 184**.
  - STEP 4** To save your changes and to close the window, click **OK**.
-

### Traffic Shaping

From this tab, you enable Traffic Shaping and configure QoS settings.

These settings are primarily used in conjunction with configuring the maximum number of simultaneous calls for multisite deployments.

- See **Configuring Quality of Service (QoS), page 461** for more information and guidelines for configuring QoS for multisite deployments.
- See **Maximum Calls (Call Admission Control), page 468** for information about configuring call admission control based on these settings.

Configure settings as described in the following table. Click **OK** or **Apply** when finished.

Setting	Description
<b>Traffic Shaping</b>	Check this setting to enable QoS and traffic shaping.
<b>Upstream Bandwidth [kbps]</b>	<p>When <b>Traffic Shaping</b> is enabled, enter the actual upstream bandwidth for the site in kbps, as determined by a connection speed test or the Committed Information Rate (CIR) specified in the Service Level Agreement (SLA) for the Internet service provider.</p> <p>Valid values range from 384 to 100000 kbps.</p> <p>For example, if the upstream bandwidth is 1.8 Mbps, enter 1800 for the upstream bandwidth.</p> <p>If the CIR or the results of an connection speed test are not available, enter a value in kbps that is 80% of the upstream bandwidth advertised by the Internet Service Provider (ISP).</p>

Setting	Description
<b>Media Reservation (%)</b>	<p>Use the slider bar to specify the proportion of available WAN bandwidth to guarantee for voice traffic if it is present on the network.</p> <p>Valid percentages range from 1 to 95 (the remaining 5 percent covers signaling and other overhead). The default is 50%.</p> <p>If no voice traffic is present on the system, all of the available bandwidth is used for data traffic.</p>

For more information, see [Modify Internet Connection, page 184](#).

## Modify Internet Connection

This window appears when you click **Modify** on the Internet Connection window.

To enable and configure an Internet connection on an interface or configure optional Dynamic DNS settings, complete the settings in this window as described below, then click **OK**.

Setting	Description
<b>Enable WAN Interface</b>	When checked, this setting enables an Internet connection.
<b>PPPoE</b>	<p>Check the PPPoE check box to choose PPPoE for the Internet connection, if required by your service provider. If PPPoE is checked, configure these additional settings. These are obtained from your service provider.</p> <ul style="list-style-type: none"> <li>▪ <b>Username</b>—Username required for PPPoE connection.</li> <li>▪ <b>Password</b>—PAP/CHAP authentication password required for PPPoE connection.</li> <li>▪ <b>Re-enter Password</b>—Re-enter password for confirmation.</li> </ul>



Setting	Description
<b>IP Negotiated</b>	<p>This option is only available with PPPoE encapsulation.</p> <p>Enable the <b>IP Negotiated</b> option if required by your service provider.</p> <p>When <b>IP Negotiated</b> is enabled, the router obtains an IP address by using PPP/IPCP address negotiation.</p>
<b>Static IP</b>	<p>Click <b>Static IP</b> to use a static IP address obtained from your service provider.</p> <p>If you choose <b>Static IP</b>, you must also enter these settings. These are obtained from your service provider.</p> <ul style="list-style-type: none"> <li>▪ <b>Internet IP Address</b></li> <li>▪ <b>Subnet Mask</b></li> <li>▪ <b>Default Gateway</b>—IP address of the default gateway.</li> <li>▪ <b>Primary DNS Server IP Address</b> (required)</li> <li>▪ <b>Secondary DNS Server IP Address</b> (optional)</li> </ul> <p>Later, if you want to modify the Internet connection to use DHCP instead of a static IP address, you are prompted to delete existing SSL VPN and VPN Server configuration settings before continuing.</p>
<b>DHCP</b>	<p>Choose DHCP to have the router lease an IP address from a remote DHCP server.</p>

Setting	Description
<p><b>HTTP DDNS</b></p> <p><i>Optional.</i> Configure settings for Dynamic Domain Name Service (DDNS).</p> <p>Site that use DHCP to dynamically obtain an IP address can use a Dynamic DNS (DDNS) hosting service to allow aliasing of dynamic (DHCP) IP addresses to static hostnames.</p> <p>DDNS can also be configured for devices with an IP Negotiated WAN IP address.</p> <p>Sites that use DHCP that are also part of a multisite deployment must configure HTTP DDNS.</p>	
<p><b>Provider</b></p>	<p>Choose a DDNS provider from the pull-down menu.</p> <p>You must create your own DDNS account with one of these providers outside of Configuration Assistant.</p> <p>These DDNS hosting services are available.</p> <ul style="list-style-type: none"> <li>▪ <a href="http://cgi.tzo.com">cgi.tzo.com</a></li> <li>▪ <a href="http://dup.hn.org">dup.hn.org</a></li> <li>▪ <a href="http://members.dyndns.org">members.dyndns.org</a></li> <li>▪ <a href="http://members.easydns.com">members.easydns.com</a></li> <li>▪ <a href="http://www.dynx.cx">www.dynx.cx</a></li> <li>▪ <a href="http://www.justlinux.com">www.justlinux.com</a></li> <li>▪ <a href="http://www.zoneedit.com">www.zoneedit.com</a></li> </ul>
<p><b>Hostname</b></p>	<p>Unique hostname for this site, obtained from your DDNS provider. This is usually a Fully Qualified Domain Name (FQDN) for example, <a href="http://myhost.mydomain.net">myhost.mydomain.net</a>, but might be different for some DDNS services. The hostname must be registered.</p> <p>This field is not validated by Configuration Assistant. Make sure that you have entered the hostname exactly as specified by your DDNS provider.</p> <p>If you are configuring a multisite deployment, each site must have a unique DDNS hostname.</p>

Setting	Description
<b>Username</b>	Account user name, obtained from your DDNS provider.
<b>Password</b>	Account password, obtained from your DDNS provider.
<b>Confirm Password</b>	Re-enter the password for confirmation.

For more information, see these topics:

- [Configuring DDNS, page 460](#)
- [Configuring Quality of Service \(QoS\), page 461](#)
- [Voice Features Supported Across Multiple Sites, page 467](#)

## DHCP Server

To configure DHCP Server settings, choose **Configure > Routing > DHCP Server** from the feature bar.

### Overview

A DHCP (Dynamic Host Configuration Protocol) IP address pool is a range of IP addresses that a DHCP server can dynamically issue to client devices. Because not all clients are connected all the time, providing IP addresses as needed reduces the number of IP addresses required to serve a group of clients by reusing the same IP address for different clients at different times.

To manage the DHCP IP address pool, you can:

- Create a DHCP IP address pool that identifies the range of IP addresses in the pool.
- Bind a specific IP address in the pool to a specific MAC address, creating a static IP address for that client device. (Some clients require static IP addresses to maintain connectivity to support running applications.)
- Exclude specific IP address from the pool so that they will not be assigned to a client by the DHCP server. (A few IP addresses in the range might have been assigned through other processes. To avoid conflicts, you can exclude those addresses from the pool.)

The range of the pool is calculated from the network number and subnet mask. All available node-level IP addresses are included in the pool and made available to the server unless they are specifically bound to a MAC address or excluded from the pool; the server ignores manual address bindings and exclusions.

The DHCP Server window has these tabs:

- **DHCP Pools:** Display, create, modify, or delete a DHCP pool of IP addresses.
- **DHCP Bindings:** Manually assign IP addresses in the DHCP pool to the MAC addresses of clients.
- **DHCP Exclusions:** Specify the IP address that the DHCP server should not assign to (exclude from) clients.

### DHCP Pools

A DHCP (Dynamic Host Configuration Protocol) IP address pool is a range of IP addresses that a DHCP server can dynamically issue to client devices.

Two default DHCP pools are created for the UC500: **phone** and **default**. These default DHCP pools can be modified, but these default pool names are reserved and cannot be modified.

- The **phone** pool is associated with the Voice VLAN (VLAN 100) on the UC500. IP addresses from the phone DHCP pool are assigned to IP phones during auto-registration.
- The **data** pool is associated with the Data VLAN (VLAN1) on the UC500. IP addresses from this pool are assigned to devices on the data VLAN that request an IP address from the DHCP server.

To display the properties configured for a DHCP pool, click on the DHCP pool name.

To create a new DHCP pool, click **Create**, and use the Create DHCP Pool window. See [Create DHCP Pool, page 190](#).

To modify an existing DHCP pool, choose the DHCP pool, click **Modify**, and use the Modify DHCP Pool window. See [Modify DHCP Pool, page 191](#).

To delete a DHCP pool, choose the DHCP pool name, then click **Delete**. A window appears, warning you that if you proceed, you will delete the DHCP pool.

To close the window, click **OK**.

## DHCP Bindings

After you create a DHCP pool, you can manually assign IP addresses from that pool to specific devices based on their MAC address.

To create a new DHCP binding, click **Create**, and use the Create DHCP Binding window. See [Create DHCP Binding, page 191](#).

To modify an existing DHCP binding, choose the pool name, click **Modify**, and use the Modify DHCP Binding window. See [Modify DHCP Binding, page 192](#).

To delete a DHCP binding, choose the DHCP binding name, then click **Delete**. A window appears, warning you that if you proceed, you will delete the DHCP binding.

To close the window, click **OK**.

## DHCP Exclusions

From this tab, you specify individual IP addresses or ranges of IP address to be excluded from the DHCP address pool. These addresses cannot be assigned to DHCP clients.

To create a new DHCP exclusion, click **Create**, and use the Create DHCP Exclusion window. See [Create DHCP Exclusion, page 190](#).

To delete a DHCP exclusion, choose the IP address, and click **Delete**.

By default, these IP addresses are excluded from DHCP pools:

- 10.1.1.1 through 10.1.1.10 (reserved for Cisco IOS and CUE)
- 192.168.10.1 through 192.168.10.10 (reserved for the UC500)
- 10.1.1.255 and 192.168.10.255 broadcast addresses

## DHCP Pool Bindings

Two types of DHCP pool bindings can be used:

- Automatic binding — The DHCP server will create the binding. After the lease time expires, the device may get a new IP address.
- Manual binding — Use a manual binding if you want this device to use this IP address. The lease does not expire.

## Create DHCP Exclusion

This window appears when you click **Create** on the DHCP IP Exclusion tab of the DHCP Server window.

Use this dialog to add a range of DHCP IP address exclusions.

Follow these steps:

- 
- STEP 1** In the **Start IP Address** field, enter the first DHCP IP address in the range that the DHCP server should not assign to DHCP clients.
  - STEP 2** In the **End IP Address** field, enter the last DHCP IP address in the range that the DHCP server should not assign to DHCP clients.
  - STEP 3** Click **OK**.
- 

## Create DHCP Pool

This window appears when you click **Create** on the DHCP Pool tab of the DHCP Server window.

Use this dialog to create a DHCP pool and to optionally identify DNS servers, a domain name, a default router, and Windows Internet Naming Service (WINS) servers.

To create a DHCP pool, configure the settings described below, then click **OK**.

Setting	Description
<b>Name</b>	Enter the DHCP pool name.  On the UC500, the phone and data DHCP pool names are reserved for the voice (VLAN100) and data (VLAN1) VLANs.
<b>Network</b>	Starting IP address of the DHCP pool.  If you edit the Network setting for the phone and data DHCP pools on the UC500, this has the same effect as changing the IP address for these default VLANs. See <a href="#">Modifying Default VLANs, page 178</a> .

Setting	Description
<b>Subnet Mask</b>	Enter the subnet network mask.
<b>DNS Server1</b>	In the <b>DNS Server1</b> field, enter the IP address of a DNS server. DHCP clients query DNS servers to correlate hostnames to IP addresses.
<b>DNS Server2</b>	<i>Optional.</i> In the <b>DNS Server2</b> field, enter the IP address of a second DNS server.
<b>Domain Name</b>	Enter the name of the domain. The domain name of a DHCP client places the client in the domain.
<b>WINS Server1, WINS Server2</b>	<i>Optional.</i> In the <b>WINS Server1, WINS Server2</b> fields, enter the IP address of the WINS servers. These fields specify the WINS servers that are available to a Microsoft DHCP client.
<b>Default Router</b>	<i>Optional.</i> In the <b>Default Router</b> field, enter the IP address of the default gateway. When a DHCP client starts, the client begins sending packets to its default gateway. The IP address of the default gateway must be on the same subnet as the client.

## Modify DHCP Pool

This window appears when you click **Modify** on the DHCP Pools tab of the DHCP Server window.

Use this dialog to modify an existing DHCP pool, including the DNS servers, a domain name, a default router, or the WINS servers.

You cannot modify the name of the default phone and data DHCP pools. All other settings can be modified for these pools.

See [Create DHCP Pool, page 190](#) for an explanation of the fields in this window.

Click **OK** when you are finished with this window.

## Create DHCP Binding

This window appears when you click **Create** on the DHCP Bindings tab of the DHCP Server window.

To create a DHCP binding, configure settings as described below, then click **OK**.

Setting	Description
<b>Name</b>	Enter a name for the DHCP server address pool.
<b>Host IP Address</b>	Enter the host IP address.
<b>Netmask</b>	Enter the host subnet network mask.
<b>MAC Address</b>	Enter the MAC address. It specifies a hardware address for the client or the distinct identification of the client in dotted hexadecimal notation. For example, 01b7.0813.8811.66.
<b>Client Name</b>	Enter the client name using standard ASCII characters.  The client name must not be the domain name. For example, do <i>not</i> specify the name mars as mars.cisco.com.

## Modify DHCP Binding

This window appears when you click **Modify** on the DHCP Bindings tab of the DHCP Server window.

Use this dialog to modify a DHCP binding.

See [Create DHCP Binding, page 191](#) for an explanation of the fields in this window.

Click **OK** when you are finished with this window.

## Static Routing

To configure static routes, choose **Configure > Routing > Static Routing** from the feature bar.

Use this window to add a static route to or delete a static route from a router.

### Overview

You can add a static route to the static routing table in a router.



- A static route is hard-coded into the static routing table of the device, so any static route that you configure is not removed from the routing table until you delete it or replace it.
- A static route has priority over all dynamic routes and reduces processing time by quickly determining the path for a packet. Dynamic routes are learned by the device by using IP routing protocols such as RIP, require more processor time, and age out of the routing table if they are not refreshed.

On the UC500, a static route is created to 10.1.10.1, the Integrated-Service-Engine-0/0 interface, which is the Cisco Unity Express (CUE) module. Do not delete this route.

**Procedures**

Begin by selecting the device to be configured from the Hostname list.

- To add a static route, click **Add**, and use the Add Static Route window. See [Add Static Route, page 193](#).
- To delete a static route, choose the static route to be removed, then click **Delete**.

Click **OK** to close the window.

**Add Static Route**

This window appears when you click **Add** on the Static Routing window.

To add a static route to a router, configure settings as described below, then click **OK** to close the window and save your changes.

Setting	Description
<b>Destination/ Network IP field</b>	Enter the IP address of the destination network.
<b>Network Mask</b>	Enter the subnet mask of the destination network.

---

Setting	Description
<b>Gateway IP or Outgoing Interface</b>	Choose an interface from <b>Outgoing Interface</b> list or choose <b>Enter Gateway IP</b> .  If you chose <b>Enter Gateway IP</b> , enter the IP address of the gateway or the outgoing interface in the text box below this field.

# Wireless

Configuration Assistant provides tools for configuring wireless access points and wireless LAN controllers on your system. This section includes these topics:

- [Configuring Secure Wireless Settings](#)
- [Convert to LAP \(Lightweight Access Point\)](#)
- [Wireless LAN Controller Configuration](#)

See [Wireless Setup Wizard, page 98](#) for information on using the CCA Wireless Setup Wizard to configure wireless settings and synchronize wireless profile settings on access points and SPA525G IP phones.

## Configuring Secure Wireless Settings

To configure security on wireless access points, choose **Configure > WLANs (SSID)** on the feature bar.

From the WLANs (SSIDs) window, you can:

- Configure SSID settings for wireless security
- Choose whether or not to broadcast the SSID
- View the security settings that you configured on the access point
- Configure RADIUS servers
- Configure wireless radio settings for autonomous access points
- Configure MAC authentication for AP54 1N access points
- Enable or disable the wireless interface for UC500 and SR500 devices with integrated wireless capabilities

**NOTE** To disable wireless for UC500 and SR500 devices with integrated wireless capabilities, uncheck the **Enable Wireless Interface** option in the WLANs (SSIDs) window. By default, the wireless interface is enabled for these platforms.

Wireless settings vary, depending on the type of access point you are configuring:

- [Wireless Settings for Cisco AP54 1N Access Points](#)
- [Wireless Settings for Cisco AP521 and UC500 or SR500 Built-in Access Points](#)

### Wireless Settings for Cisco AP54 1N Access Points

These sections explain the wireless configuration settings on each of the three tabs in the WLANs (SSIDs) window for Cisco AP54 1N Single-radio Dual-band access points.

- [SSIDs](#)
- [Radius](#)
- [MAC Authentication](#)

**NOTE** To configure features on the AP54 1N that are not currently managed through CCA such as clustering, use the AP54 1N Configuration Utility. To access this utility, right click on the AP54 1N icon in the Topology view and choose Configuration Utility from the pop-up menu.

### SSIDs

From the SSIDs tab, you can view, create, or modify SSIDs and their associated settings for AP54 1N access points.

Up to sixteen (16) SSIDs can be created on a single AP54 1N access point.

- To create new SSID, click **Create** to open the Create or Modify SSID window.
- To modify settings for an existing SSID, select the SSID from the list and click **Modify**.

For detailed information about SSID settings for AP54 1N access points, see [Create or Modify SSIDs for Cisco AP54 1N Access Points, page 207](#).

This table explains the settings displayed in the SSIDs window.

Setting	Description
<b>SSID</b>	<p>The Service Set Identifier configured on the access point. The SSID name cannot be modified once it is created. To change the name, delete the SSID and create a new one with a different name.</p> <p>The cisco-data (VLAN1) and cisco-voice (VLAN100) SSIDs are default SSIDs for data and voice traffic. By default, these SSIDs have security set to None. To access security settings for an existing default SSID, select the SSID and click <b>Modify</b>.</p>
<b>VLAN</b>	Displays the VLAN associated with the SSID.
<b>Security</b>	<p>Displays the type of wireless security and associated settings. For the AP541N, these security types are supported:</p> <ul style="list-style-type: none"> <li>▪ None</li> <li>▪ Static WEP</li> <li>▪ Dynamic WEP</li> <li>▪ WPA Personal</li> <li>▪ WPA Enterprise</li> </ul> <p>See <a href="#">Wireless Security Options for AP541N Devices, page 209</a> for a description of each of these options.</p>
<b>Encryption</b>	Displays one of these wireless encryption types, based on the selected security type: None, <b>WEP</b> , <b>AES</b> , or <b>TKIP</b> and <b>AES CCMP</b> .
<b>Authentication</b>	<p>Displays one or more of these authentication types, based on the selected security type.</p> <ul style="list-style-type: none"> <li>▪ None</li> <li>▪ <b>open authentication</b></li> <li>▪ <b>open authentication with EAP</b></li> <li>▪ <b>network EAP</b></li> </ul>

Setting	Description
<b>MAC Authentication Type</b>	<p>You can configure a global list of MAC addresses that are allowed or denied access to the network. Choose one of the following MAC Authentication Types:</p> <ul style="list-style-type: none"> <li>▪ <b>Local</b>—Use the MAC Authentication list that you configure on the MAC Authentication tab. See <a href="#">MAC Authentication, page 199</a>.</li> <li>▪ <b>Radius</b>—Use the MAC Authentication list configured on the external RADIUS server.</li> <li>▪ <b>Disabled</b>—Do not use MAC authentication.</li> </ul>

### Radius

From the Radius tab, you can enable and configure global settings for external RADIUS servers for accounting and authentication of wireless clients. The AP54 1N does not have a local RADIUS server.

Setting	Description
<b>RADIUS IP Address</b>	<p>Enter the address for the primary global RADIUS server.</p> <p>When the first wireless client tries to authenticate with the AP, the AP sends an authentication request to the primary server. If the primary server responds to the authentication request, the AP continues to use this RADIUS server as the primary server, and authentication requests are sent to the address that you specify.</p>
<b>RADIUS IP Address-1, RADIUS IP Address-2, RADIUS IP Address-3</b>	<p>Enter up to three IPv4 addresses for the backup RADIUS servers.</p> <p>If authentication fails with the primary server, each configured backup server is tried in sequence. The address must be valid in order for the AP to attempt to contact the server</p>

Setting	Description
<b>RADIUS Key</b>	<p>The RADIUS Key is the shared secret key for the primary global RADIUS server.</p> <p>You can enter up to 63 standard alphanumeric and special characters for the RADIUS Key. The key is case-sensitive, and you must configure the same key on the AP and on your RADIUS server.</p> <p>The RADIUS key is not displayed in plain text as you type it.</p>
<b>RADIUS Key-1, RADIUS Key-2, RADIUS Key-3</b>	<p>Enter the RADIUS key associated with each of the configured backup RADIUS servers.</p> <p>The server at RADIUS IP Address-1 uses RADIUS Key-1, RADIUS IP Address-2 uses RADIUS Key-2, and so on.</p> <p>You can enter up to 63 standard alphanumeric and special characters for the Radius Key. The key is case-sensitive, and you must configure the same key on the AP and on your RADIUS server.</p> <p>The RADIUS key is not displayed in plain text as you type it.</p>
<b>Enable RADIUS Accounting</b>	<p>Enable this option to track and measure the resources a particular user has consumed such as system time, amount of data transmitted and received, and so on.</p> <p>If you enable RADIUS accounting, it is enabled for the primary RADIUS server and all backup servers.</p>

### MAC Authentication

On the MAC Authentication tab, you specify a list of MAC addresses to control access to the network through the AP based on the MAC address of the wireless client. You also specify whether the clients with those MAC addresses are allowed or denied access to the network. This local list is used when **MAC Authentication** is set to Local for an SSID configured on the AP541N.

To configure MAC authentication settings, follow these steps.

- 
- STEP 1** Choose how you want to filter the clients with the MAC addresses specified in the list.
- Choose **Allow Addresses in the List** to only allow access to clients with the MAC addresses specified in the list.
  - Choose **Deny Addresses in the List** to allow access to all clients except those with the MAC addresses specified in the list.
- STEP 2** Click **Add** to open a new row in the table.
- STEP 3** Click anywhere in the row and enter the 12-digit hexadecimal MAC address of the client to add to the list.
- Enter MAC addresses using the format `xxxxx . xxxxx . xxxxx` (for example, `0101 . FEFE . 2345`). The dot (.) characters are entered automatically as you type. Do not use colons to separate hexadecimal digits in the MAC address.
- STEP 4** Continue adding MAC addresses to the list as needed.
- STEP 5** Click **Apply** or **OK** when you are finished.
- 

To remove a MAC address from the list, highlight the address in list and click **Remove**, then click **Apply** or **OK**.

#### **Wireless Settings for Cisco AP521 and UC500 or SR500 Built-in Access Points**

These sections explain the configuration settings on each of the three tabs in the WLANs (SSIDs) window:

- **Wireless Network Names (SSIDs)**
- **RADIUS Servers**
- **Access Point Settings**

**NOTE** SR500 Series Secure Routers with built-in access points have similar settings, but the GUI for configuring these settings does not have separate tabs. See the **Wireless Network Names (SSIDs)** and **RADIUS Servers** sections for information about these settings.



### Wireless Network Names (SSIDs)

You can configure security features on your **autonomous access point**. The security features protect wireless communication between the autonomous access point and other wireless devices and prevent unauthorized entry. You can configure different levels of security and encryption on your autonomous access points. The security levels range from no security to high security.

This table explains the columns in this window.

Setting	Description
<b>SSID</b>	The Service Set Identifier configured on the access point.
<b>VLAN</b>	The VLAN associated with the SSID.
<b>Enable wireless interface</b>	This option is only displayed for UC500 and SR500 devices with integrated wireless capabilities. When this option is unchecked, the wireless interface on these devices is shut down. You can still configure SSIDs and settings when the wireless interface is shut down.
<b>Security</b>	Type of wireless security and associated settings: <ul style="list-style-type: none"> <li>▪ No Security</li> <li>▪ <b>WEP , page 213</b></li> <li>▪ <b>EAP, page 213</b></li> <li>▪ <b>LEAP, page 214</b></li> <li>▪ <b>WPA, page 214</b></li> <li>▪ <b>WPA-PSK, page 215</b></li> <li>▪ <b>WPA2, page 215</b></li> <li>▪ <b>WPA2-PSK, page 215</b></li> <li>▪ <b>MAC, page 216</b></li> <li>▪ <b>MAC &amp; EAP, page 216</b></li> <li>▪ Unknown—This appears if the security setting is configured by using the command-line interface and the security setting is not supported by Configuration Assistant.</li> </ul>

Setting	Description
<b>Encryption</b>	Wireless encryption type: <ul style="list-style-type: none"> <li>▪ None (not recommended)</li> <li>▪ <b>WEP</b></li> <li>▪ Dynamic <b>WEP</b></li> <li>▪ <b>TKIP</b></li> <li>▪ <b>AES CCMP</b></li> </ul>
<b>Authentication</b>	One or more of these authentication types: <ul style="list-style-type: none"> <li>▪ <b>open authentication</b></li> <li>▪ <b>open authentication with EAP</b></li> <li>▪ <b>network EAP</b></li> <li>▪ <b>WPA-PSK</b></li> </ul>

Follow these steps to configure SSIDs and enable security for your autonomous access points.

**STEP 1** From the **Hostname** list, select an access point.

**STEP 2** To create a Wireless LAN and select the security settings, select the Wireless Network Names (SSIDs) tab, click **Create**, and complete the Create WLAN window. See [Create or Modify WLAN SSID, page 206](#).

Multiple WLANs allow users to access different networks through a single autonomous access point.

The number of SSIDs you can create varies, depending on the type of access point being configured. For example, SR500 devices support a maximum of four (4) SSIDs.

**STEP 3** To modify a configuration, select the WLAN, click **Modify**, and use the Modify WLAN window. See [Create or Modify WLAN SSID, page 206](#).

**STEP 4** To delete a configuration, select the WLAN, and click **Delete**.

**STEP 5** To shut down the wireless interface for Cisco UC500 and SR500, uncheck the **Enable Wireless Interface** option. You can still create and modify SSIDs while the interface is shut down. The default the wireless interface is enabled.

**STEP 6** To apply your changes and to close the window, click **OK**.

### RADIUS Servers

From this tab, you can

- Configure a local RADIUS server for wireless clients, add WLAN users, and configure user passwords, or
- Enable and configure an external RADIUS server for accounting and authentication of wireless clients

Remote Authentication Dial-In User Service (RADIUS) server configuration options are only available if the UC500 has a built-in access point or the customer site has a wireless LAN controller.

Configure RADIUS server settings as described in this table, then click **Apply** or **OK**.

Column	Description
<b>Hostname</b>	Choose a hostname from the drop-down list.
<b>External RADIUS Server</b>	
Enable External RADIUS Server	When this option is checked, enables configuration of an external RADIUS server for authentication of wireless clients.
IP Address	IP address of the external RADIUS server.
Secret Key	Shared secret key that the WLAN controller or access point uses to communicate with the external RADIUS server.
Authentication Port	RADIUS server authentication port number. The default is 1812.
Accounting Port	RADIUS server accounting port number. The default is 1813.

Column	Description
<b>Local RADIUS Server</b>	
Enable Local RADIUS Server	When this option is checked, enables configuration of a local RADIUS server for authentication of wireless clients.
Secret Key	Shared secret key that the WLAN controller or access point uses to communicate with the local RADIUS server.
Users	Username and password for each client allowed to authenticate by using the local RADIUS server.  Click <b>Add</b> to insert a new row in the table and enter a username and password.
MAC Addresses	The MAC addresses of the clients allowed to authenticate by using the local RADIUS server.  Click <b>Add</b> to insert a new row in the table and enter the MAC address in the format xxxx.xxxx.xxxx.xxxx. For example: 105b.aaab.99ac.0056

**Access Point Settings**

Configure Access Point settings as described in this table, then click **OK** or **Apply**.

Parameter	Description
<b>Channel Settings</b>	
The available selection of radio channels is determined by your regulatory domain.	
<b>Channel</b>	Select the radio channel to use for this access point. When Least Congested Frequency is selected for the channel setting, the device scans for the radio channel that is the least busy and selects that channel for use.  The device scans at power-up and when the radio settings are changed.  You can also select specific channel settings from the Channel drop-down menu.

Parameter	Description
<b>World Mode Settings</b>	
<b>Enable World Mode</b>	
<p>You can configure the wireless device to support world mode. When you enable world mode, the wireless device adds channel carrier set information to its beacon. Client devices with world mode enabled receive the carrier set information and adjust their settings automatically. For example, a client device used primarily in Japan could rely on world mode to adjust its channel and power settings automatically when it travels to Italy and joins a network there.</p>	
<b>Country</b>	Choose the primary country for this access point.
<b>Placement</b>	Choose indoor, outdoor, or both to indicate the placement of the access point.
<b>Power Level</b>	
<p>Power Level settings determine the power level of the radio transmission.</p> <p>The default power setting is the highest transmit power allowed in your regulatory domain. Government regulations define the highest allowable power level for radio devices. This setting must conform to established standards for the country in which you use the device. To reduce interference, limit the range of your access point; to conserve power, select a lower power setting.</p> <p>For an 802.11g radio, the Transmit Power setting is divided into CCK Transmitter Power (dBm) and OFDM Transmitter Power (dBm). The power settings may be in mW or in dBm depending on the particular radio that is being configured. The Power Translation Table (see <a href="#">Power Translation Table, page 206</a>) translates both mW and dBm.</p>	
<b>CCK Transmitter Power (dBm)</b>	CCK is the modulation used in 802.11g for the lower frequency rates. In most cases you can select the Maximum; available selections range from 3 dBm to 17 dBm.
<b>OFDM Transmitter Power (dBm)</b>	OFDM is the modulation used in 802.11g for higher data rates (above 20 Mbps). In most cases, you can select the Maximum; available selections range from 3 dBm to 17 dBm.

Parameter	Description
<b>Client Power (dBm)</b>	<p>Client Power determines the maximum power level allowed on client devices that associate to the access point.</p> <p>When a client device associates to the access point, the access point sends the maximum power level setting to the client. In most cases you can select the Maximum; available selections range from 3 dBm to 17 dBm.</p>

#### Antenna Settings (UC520 and UC540 Wireless SKUs only)

You should only modify these antenna settings if instructed by Cisco Support. The UC520 and UC540 wireless SKUs only have one antenna.

<b>Receive Antenna</b>	For UC520 and UC540 wireless SKUs, the Receive Antenna must be set to <b>Primary</b> .
<b>Transmit Antenna</b>	For UC520 and UC540 wireless SKUs, the Transmit Antenna must be set to <b>Primary</b> .

#### Power Translation Table

##### Approximate Translation Between mW and dBm

<b>dBm</b>	-1	2	5	6	7	8	9	10	11	12	13	14	15	16	17	18	19	20	21	22	23	24
<b>mW</b>	1	2	3	4	5	6	8	10	12	15	20	25	30	40	50	60	80	100	125	150	200	250

## Create or Modify WLAN SSID

This window appears when you click **Create** or **Modify** in the WLAN (SSIDs) window. Use the window to create a new SSID and to specify security settings for wireless access.

WLAN SSID settings vary, depending on the type of access point you are configuring:

- [Create or Modify SSIDs for Cisco AP541N Access Points](#)
- [Create or Modify SSIDs for Cisco AP521 or UC500 Built-in Access Points](#)

## Create or Modify SSIDs for Cisco AP541N Access Points

To create a new SSID for a Cisco AP541N access point, follow these steps.

**STEP 1** Configure basic SSID settings for the AP541N as described in the following table.

Setting	Description
<b>SSID</b>	In the SSID field, enter an SSID. The SSID can contain up to 32 alphanumeric characters. The double quote (") character is not allowed.
<b>Broadcast SSID</b>	Specify whether to allow the AP541N to broadcast the Service Set Identifier (SSID). Broadcast SSID is disabled by default. When SSID Broadcast is disabled, the network name is not displayed in the list of available networks on a client. Instead, the client must have the exact network name configured before it is able to connect.  Disabling the broadcast SSID is sufficient to prevent clients from accidentally connecting to your network, but it does not prevent even the simplest of attempts by a hacker to connect or monitor unencrypted traffic. Suppressing the SSID broadcast offers a very minimal level of protection on an otherwise exposed network (such as a guest network) where the priority is making it easy for clients to connect and where no sensitive information is available.
<b>VLAN</b>	Enter the VLAN ID to associated with this SSID. Valid values range from 1 to 4094.  The default VLAN for voice traffic is VLAN100, and the default VLAN for data traffic is VLAN1.  CCA does not check to make sure that the VLAN exists on the network, so you must be sure to enter a valid VLAN ID in this field.

**STEP 2** In the **Security Settings** section of the window, choose the type of security to use for this SSID and configure additional settings required for that type of security.

Settings vary, depending on the selected security type. For detailed information about each security type and its associated settings, see [Wireless Security Options for AP541N Devices, page 209](#).

**STEP 3** Choose the **MAC authentication Type**.

Setting	Description
<b>Disabled</b>	Do not use MAC authentication.
<b>Local</b>	Use the MAC Authentication list that you configure on the MAC Authentication tab in the Wireless (SSIDs) tab. See <a href="#">MAC Authentication, page 199</a> .
<b>Radius</b>	Use the MAC Authentication list specified on the external RADIUS server.

**STEP 4** Click **Apply** or **OK**.

### Create or Modify SSIDs for Cisco AP521 or UC500 Built-in Access Points

To create or modify SSIDs for Cisco AP521 access points and UC500 built-in access points, follow these steps:

- STEP 1** In the **SSID** field, enter an SSID. The SSID can contain up to 32 alphanumeric characters.
- STEP 2** Check **Broadcast in Beacon** if you want to broadcast the SSID so that the devices that do not specify an SSID can associate (establish a wireless connection) with the autonomous access point. Only one SSID can be included in beacon (the guest SSID).
- STEP 3** In the **VLAN** field, enter or choose the VLAN ID that you want to associate with the SSID.
- If you assign a VLAN to any SSID, you must assign a VLAN to every SSID. You cannot have some SSIDs assigned to VLANs and others assigned to *none*.
- STEP 4** Check the **Native VLAN** box if you want this VLAN to be the **native VLAN**.
- STEP 5** In the Security Settings area, select the security setting from the **Security** list. The remaining options in this window depend upon what you choose.



You can select **No Security**, **WEP**, **EAP**, **LEAP**, **WPA**, **WPA-PSK**, **WPA2**, **WPA2-PSK**, **MAC**, or **MAC & EAP**.

See **Wireless Security Options for UC500W and AP521 Devices**, page 213 for a description of each of these settings.

Configuration Assistant automatically selects the encryption and authentication type depending on the security setting that you select.

**STEP 6** Click **OK** to save your changes and to close the window.

## Wireless Security Options for AP541N Devices

This section describes wireless security options and related settings for AP541N access points.

### None

If you select **None** as your security mode, no additional security settings are required. Data transferred to and from the access point is not encrypted and no authentication is performed. This mode can be useful during initial network configuration or troubleshooting, but it is not recommended for regular use on the internal network because it is not secure.

### Static WEP

The **Static WEP** security setting requires that the autonomous access point and the client device (device that connects to the wireless device such as a laptop or PC) share the same WEP key to keep the communication private.

Static WEP is not the most secure mode available, but it offers more protection than setting the security mode to None (Plain-text).

If you choose **Static WEP**, configure these additional settings.

Setting	Description
<b>Encryption</b>	Ready-only. AES encryption is used.
<b>Authentication</b>	Read-only. Network-EAP authentication is used.
<b>Key Length</b>	Choose either 64-bits or 128-bits for the encryption key length.

Setting	Description
<b>Key Type</b>	Choose either <b>ASCII</b> or <b>HEX</b> (hexadecimal).
<b>Key</b>	<p>You can specify up to four WEP keys. For each key, enter a string of characters. Use the same number of characters for each key. These are the WEP keys shared with the stations using the AP. The keys you enter depend on the Key Type selected.</p> <p><b>ASCII.</b> Includes upper and lower case alphabetic letters, the numeric digits, and special symbols such as @ and #.</p> <p><b>Hex.</b> Includes digits 0 to 9 and the letters A to F.</p> <p>The number of characters you enter in the Key fields is determined by the Key Length and Key Type you select. For example, if you use 128-bit ASCII keys, the WEP key must have 13 characters.</p>

### Dynamic WEP

Dynamic WEP provides dynamically-generated keys that are periodically refreshed.

This mode requires the use of an external RADIUS server to authenticate users. The AP requires a RADIUS server capable of EAP, such as the Microsoft Internet Authentication Server. To work with Windows clients, the authentication server must support Protected EAP (PEAP) and MSCHAP V2.

If you choose Dynamic WEP for security, configure these additional settings.

Setting	Description
<b>Encryption</b>	Read-only. AES encryption is used.
<b>Authentication</b>	Read-only. Network-EAP authentication is used.
<b>Active Server</b>	<p>Displays which RADIUS server is currently in use. You can manually update the server by selecting a different server from the drop-down list.</p> <p><b>NOTE</b> The Active Server is not stored across restarts. The first configured RADIUS server is selected upon restart.</p>

Setting	Description
<b>Broadcast Key Refresh Rate</b>	Enter a value to set the interval at which the broadcast (group) key is refreshed for clients associated to this SSID.  Valid values range from 1 to 86400 seconds. A value of 0 indicates that the broadcast key is not refreshed.
<b>Session Key Refresh Rate</b>	Enter a value to set the interval at which the AP will refresh session (unicast) keys for each client associated with this SSID.  The valid range is from 0 to 86400 seconds. A value of 0 indicates that the broadcast key is not refreshed.

### WPA Personal

WPA Personal is a Wi-Fi Alliance IEEE 802.11i standard that includes AES-CCMP and TKIP encryption. The Personal version of WPA employs a pre-shared key (instead of using IEEE 802.1X) and EAP as is used in the Enterprise WPA security mode). The pre-shared key (PSK) is used for an initial check of credentials only.

This security mode is backwards-compatible for wireless clients that support the original WPA.

If you choose **WPA Personal**, configure these additional settings.

Setting	Description
<b>Encryption</b>	Read-only. TKIP, AES-CCM P is used.
<b>Authentication</b>	Read-only. Open-EAP, Network-EAP authentication is used.
<b>Key</b>	Enter the pre-shared secret key for WPA Personal security. The key can contain from 8 to 63 characters. Acceptable characters include upper and lower case alphabetic letters, digits 0 through 9, and special symbols such as @ and #.
<b>Broadcast Key Refresh Rate</b>	Enter a value from 0 to 86400 seconds to set the interval at which the broadcast (group) key is refreshed for associated clients. A value of 0 indicates that the broadcast key is not refreshed.

## WPA Enterprise

WPA Enterprise with RADIUS is an implementation of the Wi-Fi Alliance IEEE 802.11i standard, which includes CCMP (AES), and TKIP mechanisms. The WPA Enterprise mode requires the use of a RADIUS server to authenticate users.

This security mode is backwards-compatible with wireless clients that support the original WPA.

If you choose WPA Enterprise, configure these additional settings.

Setting	Description
<b>Encryption</b>	<p>Read-only. Both TKIP and AES-CCMP are selected.</p> <p>When both TKIP and CCMP are selected, clients configured to use WPA with RADIUS must have one of the following:</p> <ul style="list-style-type: none"> <li>▪ A valid TKIP RADIUS IP address and RADIUS key</li> <li>▪ A valid CCM (AES) IP address and RADIUS key</li> </ul>
<b>Active Server</b>	<p>Displays which RADIUS server is currently in use. You can manually update the server by selecting a different server from the drop-down list.</p> <p><b>NOTE</b> The Active Server is not stored across restarts. The first configured RADIUS server is selected upon restart.</p>
<b>Broadcast Key Refresh Rate</b>	<p>Enter a value to set the interval at which the broadcast (group) key is refreshed for clients associated to this AP.</p> <p>Valid values range from 1 to 86400 seconds. A value of 0 indicates that the broadcast key is not refreshed.</p>
<b>Session Key Refresh Rate</b>	<p>Enter a value to set the interval at which the AP will refresh session (unicast) keys for each associated client.</p> <p>The valid range is from 0 to 86400 seconds. A value of 0 indicates that the broadcast key is not refreshed.</p>

---

## Wireless Security Options for UC500W and AP521 Devices

This section describes wireless security options and related settings for AP521 access points and UC500 platforms that have an embedded access point.

### No Security

This is the least secure option. Select it only for an SSID that is used in a public place (guest SSID) and associate it with a VLAN that restricts access to your network. There is no encryption, and the authentication type is **open authentication**.

### WEP

This security setting requires that the autonomous access point and the client device (device that connects to the wireless device such as a laptop or a PC) share the same **WEP** key to keep the communication private. The encryption type is WEP, and the authentication type is **open authentication**.

To set this kind of security:

- 
- STEP 1** Enter a passphrase in the **Passphrase** field, and select the bit encryption from the list.
  - STEP 2** Click **Generate**. The key field located next to the **Key** list is automatically filled in. You can change the key number by selecting either 1, 2, 3, or 4 in the **Key** list. The default key number is 1.
- 

### EAP

This security setting enables IEEE 802.1X authentication and requires you to enter the IP address and shared secret for a **RADIUS** server. The encryption type is dynamic **WEP**, and the authentication type is **open authentication with EAP**.

If you select the EAP security type, wireless clients must use EAP settings (for example, EAP-TLS, EAP-FAST, or PEAP). Wireless clients cannot use LEAP settings.

To set this kind of security:

- 
- STEP 1** Enter the IP address of the RADIUS server.
- STEP 2** Enter the shared secret that the autonomous access point will use to communicate with the RADIUS server.
- 

### LEAP

This security setting enables IEEE 802.1X authentication and requires you to enter the IP address and shared secret for a **RADIUS** server. The encryption type is dynamic WEP, and the authentication types are **open authentication with EAP** and **network EAP**.

#### Notes

- If you select the LEAP security type, wireless clients must use LEAP settings.
- Configuration Assistant enables both Open authentication with EAP and Network EAP authentication to allow both Cisco client devices and non-Cisco client devices to associate with the autonomous access point by using the same SSID to perform IEEE 802.1x authentication.

To set this kind of security:

- 
- STEP 1** Enter the IP address of the RADIUS server.
- STEP 2** Enter the shared secret that the autonomous access point will use to communicate with the RADIUS server.
- 

### WPA

This security setting is more secure than the EAP setting. It enables **WPA** authentication and requires you to enter the IP address and shared secret for a RADIUS server. Client devices that associate to the autonomous access point by using this SSID must be WPA-capable. The encryption type is **TKIP**, and the authentication types are **open authentication with EAP** and **network EAP**.

Configuration Assistant enables both **Open authentication with EAP** and **Network EAP authentication** to allow both Cisco client devices and non-Cisco client devices to associate with the autonomous access point by using the same SSID to perform IEEE 802.1x authentication.

---

To set this kind of security:

- 
- STEP 1** Enter the IP address of the RADIUS server.
  - STEP 2** Enter the shared secret that the autonomous access point will use to communicate with the RADIUS server.
- 

### WPA-PSK

Select this security setting when you want to use the WPA encryption and you do not have access to a RADIUS server. The autonomous access point and the client must device share the same **WPA-PSK**. The key can be from 8 to 63 characters long. The encryption type is **TKIP**, and the authentication type is **WPA-PSK**.

To set this kind of security, enter a key in the **WPA Preshared Key** field.

### WPA2

This security setting is more secure than the WPA setting. It enables **WPA2** authentication and requires you to enter the IP address and shared secret for a RADIUS server. Client devices that associate to the autonomous access point by using this SSID must be WPA2-capable. The encryption type is **AES CCMP**, and the authentication types are **open authentication with EAP** and **network EAP**.

Configuration Assistant enables both **Open authentication with EAP** and **Network EAP authentication** to allow both Cisco client devices and non-Cisco client devices to associate with the autonomous access point by using the same SSID to perform IEEE 802.1x authentication.

To set this kind of security:

- 
- STEP 1** Enter the IP address of the RADIUS server.
  - STEP 2** Enter the shared secret that the autonomous access point will use to communicate with the RADIUS server.
- 

### WPA2-PSK

Select this security setting when you want to use the WPA2 encryption and you do not have access to a RADIUS server. It requires that the autonomous access point and the client device share the same WPA2-PSK. The key can be from 8 to 63 characters long. The encryption type is **AES CCMP**, and the authentication type is **WPA-PSK**.

To set this kind of security, enter a key in the **WPA2 Preshared Key** field.

### MAC

Select this security setting when you want to authenticate client devices by using MAC-based authentication.

There is no encryption, and the authentication type is Open authentication.

To set this kind of security:

- 
- STEP 1** Enter the IP address of the RADIUS server.
  - STEP 2** Enter the shared secret that the autonomous access point will use to communicate with the RADIUS server.
- 

### MAC & EAP

Select this security setting when you want to authenticate client devices by using a combination of MAC-based and EAP authentication. Client devices that associate with the access point by using IEEE 802.11 open authentication first attempt MAC authentication. If MAC authentication succeeds, the client device joins the network; if the client is also using EAP authentication, it attempts to authenticate using EAP. If MAC authentication fails, the access point waits for the client device to attempt EAP authentication.

The encryption type is dynamic WEP, and the authentication types are Open authentication with EAP and Network EAP.

Configuration Assistant enables both **Open authentication with EAP** and **Network EAP authentication** to allow both Cisco client devices and non-Cisco client devices to associate with the autonomous access point by using the same SSID to perform 802.1x authentication.

To set this kind of security:

- 
- STEP 1** Enter the IP address of the RADIUS server.
  - STEP 2** Enter the shared secret that the autonomous access point will use to communicate with the RADIUS server.
-



## Resolve Guest VLAN Window

The Resolve Guest VLAN window appears if a Guest VLAN is already configured on an ESW500 Series switch and you open the WLAN (SSIDs) window with the SR520 selected as the host.

Click **Resolve** to create the Guest VLAN on the SR520. Click Cancel if you do not want CCA to create the Guest VLAN on the SR520.

## Convert to LAP (Lightweight Access Point)

This window appears when you choose **Configure > Wireless > Convert to LAP** on the feature bar.

You can convert an **autonomous access point** to a **lightweight access point**. A lightweight access point associates to a wireless LAN controller. The controller manages the configuration, firmware, and control transactions such as 802.1x authentications. In addition, all wireless data traffic is tunneled through the controller.

To convert an autonomous access points to a lightweight access point, choose and use the Convert to LAP window See **Convert to LAP (Lightweight Access Point), page 217**). You can select multiple autonomous access points and convert them at the same time.

Conversion from LAP access points to autonomous AP is not supported by CCA. CCA will not be able to manage LAP access points converted to autonomous mode using the Cisco IOS command-line interface (CLI).

This table explains the settings in the Convert to LAP window.

Setting	Explanation
<b>Device</b>	Displays device icons and hostnames.
<b>Convert</b>	Shows whether the device is selected for a <b>Conversion</b> .
<b>Device Type</b>	Displays the device type.
<b>Current Version</b>	Displays the current Cisco IOS version.

<b>Recovery Image Name</b>	Displays the name of the Cisco IOS tar file that you provided in the Conversion Settings window. Only the filename appears, not the path.
<b>Conversion Status</b>	Displays the conversion status and progress messages. See the Conversion Status window for details.
<b>IP Address</b>	Displays the IP address setting that you provided in the Conversion Settings window, either static or DHCP.
<b>Hostname</b>	Displays the hostname setting that you provided in the Conversion Settings window, either Retain or Do Not Retain.

Follow these steps to convert autonomous access points to lightweight access points:

- 
- STEP 1** Download the Cisco IOS tar files that you want to use to convert the autonomous access point.
  - STEP 2** Select one or more autonomous access points.
  - STEP 3** Click **Conversion Settings**.
  - STEP 4** Complete the Conversion Settings window, and click **OK** to save your entries. See [Conversion Settings, page 219](#).
  - STEP 5** Check the **Convert** box beside each device that you want to convert now.
  - STEP 6** Click **Convert** to start the conversion process.

The current image is deleted, and the new image is downloaded. You can save the old image by using the command-line interface (CLI).

- STEP 7** Click **Status** to display the Conversion Status window. This window displays the progress of the conversion. See [Conversion Status, page 220](#).

When the conversion process is completed, a confirmation dialog pops up. The status messages list which access points converted successfully and which access points did not.

- STEP 8** All configuration changes are automatically saved to flash memory. After one (1) minute, the devices are reloaded, and the new image starts running. You can then close the Convert to LAP window.

You lose connectivity to a device when you reload it.

---

---

## Conversion Settings

This window appears when you select one or more **autonomous access points** in the Convert to LAP window and click **Conversion Settings**.

Select **DHCP IP Address** if you want the WLAN controller to assign a new IP address to the lightweight access point after the conversion.

Select **Retain Hostname** if you want to retain the same hostname for the lightweight access point after the conversion.

From the **Mode** list, select **Standard** to use a conversion image that is stored locally; otherwise, select **Remote TFTP Server**.

If you selected **Standard**, enter the filename of the conversion image in the **Conversion Image** field. You can click **Browse** to find the file.

If you selected **Remote TFTP Server**:

- 
- STEP 1** In the **Conversion Image** field, enter the full path and filename of the conversion image.
  - STEP 2** In the **TFTP Server IP Address** field, enter the IP address of your TFTP server.  
To perform group conversions, your TFTP server must handle multiple requests and sessions simultaneously.
  - STEP 3** In the **Domain Name** field, enter the domain name.
  - STEP 4** In the **DNS IP Address** field, enter the **DNS** address.
  - STEP 5** Click **OK** to save your settings. They appear in the Convert to LAP window.
-

## Conversion Status

This window appears when you select one or more **autonomous access points** in the Convert to LAP window and click **Status**. The window shows detailed messages as they are generated from the autonomous access point during a conversion.

This table explains conversion status messages.

Message	Explanation
Click the <b>Conversion Settings</b> button to continue.	The Conversion Settings window needs to be completed before the device can be converted.
Click the <b>Convert</b> button to upgrade the device.	All the parameters are set for the device to be converted.
Determining the total flash size.	The conversion process checks whether there is enough space available to convert the device.
Extracting the info file from the tar image file.	The Cisco IOS image tar file is extracting the info file.
Reading the info file of the tar image file.	Configuration Assistant reads the info file of the Cisco IOS image tar file for details about the Cisco IOS image.
Reload started for the device.	The device is reloading after a successful conversion. Even after the reload is completed, this message appears until you refresh the window.
Device conversion was successful.	The conversion completed successfully.
Device conversion failed.	The conversion failed. See the Details window for more information.
Device conversion in progress.	The conversion for the devices is in process.
Device conversion canceled.	The conversion was canceled.
Uploading the image.	The image is being uploaded to the device.

Message	Explanation
Verifying the IOS image.	The device is verifying the image.

If there is insufficient space on the device to install the new image, a message with a link to the File Management window appears. You can use the File Management window to manage your file systems, and, if necessary, to delete old images to make space for new images.

Click **OK** when you are done with the window.

## Wireless LAN Controller Configuration

The topics in this section cover configuration settings for WLAN controllers:

- [Configuring Wireless Interfaces for a WLAN Controller, page 221](#)
- [Viewing Wireless Client Status for a WLAN Controller, page 224](#)
- [Configuring WLAN Users, page 225](#)
- [DHCP Proxy, page 230](#)
- [Wireless Controller Dashboard, page 231](#)
- [Configure RADIUS Server Settings for WLAN Controllers, page 233](#)

### Configuring Wireless Interfaces for a WLAN Controller

If your system includes a Wireless LAN controller, choose **Configure > Wireless Interfaces** from the feature bar.

#### Overview

You can configure dynamic wireless interfaces on a WLAN controller. Dynamic wireless interfaces are analogous to VLANs for wireless LAN clients. A controller can support up to 8 dynamic interfaces (VLANs).

A wireless interface has multiple parameters associated with it, including VLAN identifier, port, IP address, subnet mask, default gateway (for the IP subnet), and DHCP server.

Use this window to view all wireless interface settings on the WLAN controller and to configure dynamic (user-defined) wireless interfaces on the WLAN controller.

## Procedures

This table explains the columns in the Wireless Interfaces window.

Column	Explanation
<b>Name</b>	The wireless interface name, including dynamic interfaces and static interfaces (management, ap-manager, and virtual)
<b>VLAN</b>	The VLAN associated with the wireless interface
<b>Port</b>	The physical port number for the wireless interface
<b>IP Address</b>	The IP address of the wireless interface

Follow these steps to configure a dynamic wireless interface on the WLAN controller:

- 
- STEP 1** From the **Hostname** list, select the WLAN controller.
- STEP 2** To create an interface, click **Create**, and complete the Create Interface window. See [Create Interface, page 222](#).

A controller can support up to eight dynamic interfaces.

---

To modify a configuration, select the wireless interface name, click **Modify**, and use the Modify Interface window.

To delete a configuration, select the wireless interface name, and click Delete.

**NOTE** You can modify and delete only dynamic interfaces. You cannot modify or delete static interfaces.

To save your changes and to close the window, click **OK** in the Wireless Interfaces window.

### Create Interface

This window appears when you click **Create** in the Wireless Interfaces window. Use the window to create a wireless interface.

- 
- STEP 1** In the **Interface name** field, enter a name for the wireless interface.
  - STEP 2** In the **VLAN ID** field, enter the VLAN ID that you want to associate with the wireless interface.
  - STEP 3** From the **Port** list, select a port for the wireless interface.
  - STEP 4** In the **IP Address field**, enter an IP address for the wireless interface.
  - STEP 5** From the **Subnet Mask** list, select the subnet mask for the wireless interface.
  - STEP 6** In the **Gateway IP Address** field, enter the IP address of the default gateway.
  - STEP 7** In the **DHCP Server IP Address** field, enter the IP address of the DHCP server.
  - STEP 8** When you complete this window, click **OK** to save your changes and to close the window.
- 

### Modify Interfaces

This window appears when you click **Modify** in the Wireless Interfaces window. Use the window to modify the settings for a wireless interface.

Follow these steps:

- 
- STEP 1** In the **VLAN ID** field, enter the VLAN ID that you want to associate with the wireless interface.
  - STEP 2** From the **Port** list, select a port for the wireless interface.
  - STEP 3** In the **IP Address** field, enter an IP address for the wireless interface.
  - STEP 4** From the **Subnet Mask** list, select the subnet mask for the wireless interface.
  - STEP 5** In the **Gateway IP Address** field, enter the IP address of the default gateway.
  - STEP 6** In the **DHCP Server IP Address** field, enter the IP address of the DHCP server.
  - STEP 7** When you complete this window, click **OK** to save your changes and to close the window.
-

## Viewing Wireless Client Status for a WLAN Controller

To display the status of wireless clients on the WLAN controller use the Wireless Clients window.

This table explains the information that you see under the columns in this window.

Column	Explanation
<b>MAC Address</b>	The MAC address of the client.
<b>Status</b>	The status of the client connection: <ul style="list-style-type: none"><li>▪ Idle</li><li>▪ Pending</li><li>▪ Authenticated</li><li>▪ Associated</li><li>▪ Active</li><li>▪ Power Save</li><li>▪ Disassociated</li><li>▪ Exclude</li><li>▪ Probing</li></ul>
<b>AP Name</b>	The name of the client's lightweight access point
<b>SSID</b>	The SSID of the client
<b>Radio</b>	The type of client: <ul style="list-style-type: none"><li>▪ 802.11a</li><li>▪ 802.11b</li><li>▪ 802.11g</li></ul>
<b>Authenticated</b>	The authentication status of the client (yes or no)

To close the window, click **OK**.



## Configuring WLAN Users

You can configure wireless users on the WLAN controller. You can also configure authentication and Web login settings.

Wireless users can be guests or not (for example, employees).

Guest users have access to the Internet and the guests' own network without compromising your network's security. Guest user access is configured with an expiration date.

Users who are not guests have secure access to the network. There is no expiration date for this type of user access.

Use this window to configure wireless users on the WLAN controller or to view wireless user settings that you configured on the WLAN controller.

This table explains the columns in the Wireless Network Users area.

Column	Explanation
<b>Username</b>	The name of the wireless user.
<b>Guest User</b>	The guest user status (yes or no).
<b>SSID</b>	The SSID name.
<b>End Time</b>	The expiry date of the guest user's access.
<b>Description</b>	The description of the wireless user.

Follow these steps to configure wireless users for the WLAN controller:

- 
- STEP 1** From the **Hostname** list, select the WLAN controller.
  - STEP 2** To create a guest or non-guest user, click **Create**, and complete the Create WLAN User window. See [Create WLAN Users, page 226](#).
  - STEP 3** To save your changes and to close the window, click **OK** in the WLAN Users window.
- 

To modify a wireless user, select the user name, click **Modify**, and use the Modify WLAN User window.

To delete a wireless user, select the user name, and click **Delete**.

Guest Users are deleted automatically from the Wireless Network Users list when you open the WLAN Users Window and the Guest User end time has expired. If the WLAN Users Window is already open when the Guest User end time expires and you attempt to modify the Guest User, the Guest User will be deleted from the Wireless Network Users list. Click **Create** to create a new Guest User.

To configure a login page for wireless users, click **Configure** in the Web Login area. See [Web Login, page 229](#).

## Create WLAN Users

This window appears when you click **Create** in the WLAN Users window. Use the window to create a new wireless user.

### Overview

You can configure wireless users on the WLAN controller. You can also configure authentication and Web login settings.

Wireless users can be guests or not (for example, employees).

Guest users have access to the Internet and the guests' own network without compromising your network's security. Guest user access is configured with an expiration date.

Users who are not guests have secure access to the network. There is no expiration date for this type of user access.

### Procedures

Follow these steps:

- 
- STEP 1** In the **Username** field, enter a name for the wireless user. You can enter up to 24 alphanumeric characters.
  - STEP 2** In the **Password** field, enter a password for the wireless user. You can enter up to 24 alphanumeric characters.
  - STEP 3** In the **Confirm Password** field, re-enter the password.
  - STEP 4** In the **Description** field, enter a description for the wireless user.
  - STEP 5** If the wireless user is not a guest user, follow these steps:
    - a. Uncheck the **Guest User** checkbox.
    - b. Select an SSID from the SSID list. Only SSIDs that are set with Web-Auth, WEP, WPA1-PSK, or WPA2-PSK security appear.

If you need to create an SSID, click **Add SSID (Pre-defined)** to open the Add SSID (Pre-defined) window. See [Add SSID, page 228](#)

**STEP 6** If the wireless user is a guest user, follow these steps:

- a. Check the **Guest User** checkbox.
- b. Select an SSID from the SSID list. Only SSIDs that are set with Web-Auth security appear.

If you need to create an SSID, click **Add SSID (Pre-defined)** to open the Add SSID (Pre-defined) window. See [Add SSID, page 228](#).

**STEP 7** In the **End Time** area, enter the expiry date by selecting the year, month, day, hour, and minute. The maximum expiry date for a guest user is 30 days from the current date.

When you complete this window, click **OK** to save your changes and to close the window.

---

## Modify WLAN Users

This window appears when you click **Modify** in the WLAN Users window. Use the window to modify the wireless user settings.

Follow these steps:

- 
- STEP 1** In the **Password** field, enter a password for the wireless user. You can enter up to 24 alphanumeric characters.
  - STEP 2** In the **Confirm Password** field, re-enter the password.
  - STEP 3** In the **Description** field, enter a description for the wireless user.
  - STEP 4** From the **SSID** list, select an SSID.
  - STEP 5** If the wireless user is a guest user, modify the expiry date in the **End Time** area by selecting the year, month, day, hour, and minute. The maximum expiry date for a guest user is 30 days from the current date.
  - STEP 6** When you complete this window, click **OK** to save your changes and to close the window.
-

## Add SSID

This window appears when you click **Add SSID** in the SSID area of the Create WLAN User window. Use it to apply the predefined SSID settings on the WLAN controller.

Configuration Assistant configures the corresponding VLAN and SSID with the stated security type. After you have applied the predefined SSID settings to the WLAN controller, you can modify or delete the corresponding WLAN from the WLAN (SSIDs) window. You can also modify or delete the corresponding VLAN from the VLANs window.

Follow these steps to add an SSID:

- 
- STEP 1** Select a wireless network type from the WLAN Selection area. The choices are:
- Employee Data (using Web-Auth and WPA1-PSK)
  - Employee Voice (using Web-Auth and WPA2-PSK)
- If you are configuring a guest user, the Guest (using Web-Auth) option is selected.
- STEP 2** Depending on the WLAN selection, enter this information:
- **VLAN ID (2-1000)**—Enter the ID of the VLAN.
  - **VLAN Name**—For Data networks, accept the predefined name, or enter a different name for the VLAN. For Voice or Guest networks, this field is set with a predefined VLAN name that is based on your WLAN selection.
  - **IP Address**—Enter an IP address for the VLAN.
  - **Subnet Mask**—Select the subnet mask for the VLAN.
  - **Gateway IP Address**—Enter the IP address of the default gateway.
  - **DHCP Server IP Address**—Enter the IP address of the DHCP server.
  - **SSID**—Accept the default SSID (based on the company name and your WLAN selection), or enter a different SSID of up to 32 alphanumeric characters.
  - **WPA1 Pre-Shared Key** (for data networks) or **WPA2 Pre-Shared Key** (for voice networks)—Enter a key from 8 to 63 characters long.
- STEP 3** When you complete this window, click **OK** to save your changes and to close the window.
-

## Web Login

This window appears when you click **Configure** in the Web Login area of the WLAN Users window. Use it to customize the content and appearance of the Web login page for WLAN users.

### Overview

The login page is presented to web users the first time that they access a WLAN with web authentication enabled. Cisco provides a default web login page that can be modified with any text-based HTML editor. However, the Username and Password fields should not be changed, and the Submit method should be retained. After the customized web login page is created, it must be made into a tar file containing the page code and any images desired.

### Procedures

Follow these steps to configure the login page.

- 
- STEP 1** From the **Hostname** list, select the WLAN controller.
- STEP 2** From the **Web Authentication** area, select **Internal** or **Customized**.
- STEP 3** If you select **Internal**, follow these steps:
- From the Cisco Logo area, select Show to display the Cisco logo on the login page, or select Hide to hide the logo. The default selection is Show.
  - In the Redirect URL After Login field, enter a URL to which the user will be directed after logging in. Enter the URL by using the `www.companyname.com` format with up to 254 characters.
  - In the Headline field, enter the login page headline or summary, up to 127 characters. The default headline is “Welcome to the Cisco wireless network.”
  - In the Message field, enter message text, up to 2047 characters. The default message is “Cisco is pleased to provide the wireless LAN infrastructure for your network. Please login and put your air space to work.”
- Click **Set Default** to use the default settings.
- STEP 4** If you select **Customized**, follow these steps:
- In the TFTP Server IP Address field, enter the IP address of the TFTP server on which the customized web authentication bundle file exists.

The TFTP server cannot run on the same computer as the Cisco WCS,

because the Cisco WCS and the TFTP server use the same communication port.

- b. In the **Maximum Retries** field, enter the number of attempts that the WLAN controller tries to load the web authentication file from the TFTP server on a failure. The default value is 3.
- c. In the **Timeout (seconds)** field, enter the timeout period (in seconds). If the WLAN controller is not able to start downloading the file within this time period, loading does not occur.
- d. In the **File Path** field, enter the path of the web authentication file on the TFTP server. The default value is a slash (/).
- e. In the **File Name** field, enter the name of the file to be transferred.
- f. Click **Download** to download the customized login file.

**STEP 5** When you click **OK** or **Apply**, the download starts and the customized login file is applied to the device.

---

## DHCP Proxy

To configure a DHCP proxy, choose **Configure > DHCP Proxy** from the feature bar.

A DHCP proxy helps wireless clients get an IP address from the DHCP server. The WLAN controller receives the DHCP discover request from the wireless client and sends the request to the DHCP server on behalf of the wireless client. When you enable the DHCP proxy, the WLAN controller works between the wireless client and the DHCP server until the wireless client receives an IP address.

You can enable DHCP Proxy if you configured a DHCP server address on all user-defined VLANs for this device.

To enable DHCP proxy, follow these steps.

---

**STEP 1** Select a device to be configured from the **Hostname** list.

**STEP 2** Check the **Enable DHCP Proxy** box.

**STEP 3** Click **OK** to save your changes and to close the window.

---

## Wireless Controller Dashboard

If you want information for all of the WLAN controllers in the community—for example, the status of the WLAN controller system, the status of the 802.11b/g radios, the number of clients that are associated with an SSID—choose to open the Wireless Controller Dashboard. It displays a broad range of WLAN controller information, such as:

- System summary
- Access point details and statistics
- WLAN controller statistics

It displays a broad range of WLAN controller statistics on its tabs: System, AP Summary, WLANs, WLC Statistics, and AP Statistics. To refresh the statistics, click **Refresh**.

This table explains the data of the System section.

Column	Explanation
<b>Controller Name</b>	The controller names.
<b>Up Time</b>	The amount of time that has elapsed since the WLAN controller was last rebooted.
<b>Temperature</b>	The internal chassis temperature.
<b>CPU</b>	The total CPU use of the WLAN controller.
<b>Memory</b>	The total memory use of the WLAN controller.

This table explains the data of the AP Summary section.

Column	Explanation
<b>Controller Name</b>	The controller names.
<b>802.11b/g Radios</b>	The status of the radios (Up and Down).
<b>AP Status</b>	The status of the access points (Up and Down).

This table explains the data of the WLANs section.

Column	Explanation
<b>WLAN Name (Controller Name)</b>	The SSID names of the controllers.
<b>Clients</b>	The number of clients that are associated with this SSID.

This table explains the data of the WLC Statistics section. You can choose to display the data in total numbers or in percentages.

Column	Explanation
<b>Controller Name</b>	The controller names.
<b>Packets received without error</b>	The total number or the percentage of packets received.
<b>Receive Packets Discarded</b>	The total number or the percentage of received packets discarded.
<b>Packets transmitted without error</b>	The total number or the percentage of packets sent.
<b>Transmit Packets Discarded</b>	The total number or the percentage of sent packets discarded.

This table explains the data of the AP Statistics section.

Column	Explanation
<b>AP Name (Controller Name)</b>	The associated access points with the WLAN controllers.
<b>Transmit Frame Count</b>	The total number of sent frames.
<b>Transmit Failed Count</b>	The total number of frames that failed to be sent.



## Configure RADIUS Server Settings for WLAN Controllers

The Configure RADIUS Servers window appears when you click **Configure** in the RADIUS Servers area of the WLANs (SSIDs) window for a WLAN controller.

From this window, you can view RADIUS server settings for the WLAN controller and configure up to two RADIUS servers for the WLAN controller. This table explains the columns in this window.

Setting	Description
<b>IP Address</b>	IP address of the RADIUS server.
<b>Auth Port</b>	RADIUS authentication port number.
<b>Priority</b>	The priority of the RADIUS server. It specifies the order in which the servers are used if one of the servers cannot be reached.
<b>Status</b>	The status of the RADIUS server, either Enabled or Disabled.

To configure RADIUS servers for the WLAN controller, follow these steps.

- STEP 1** From the Hostname list, select the WLAN controller.
- STEP 2** Click **Create** and complete the settings in the Create RADIUS Server window. See [Create RADIUS Server Window](#).

To change the RADIUS server status, select the IP address of the RADIUS server, click **Modify** and complete the settings in the Modify RADIUS Server Window. See [Modify RADIUS Server Window](#).

To delete a configured RADIUS server, select the IP address of the RADIUS server, and click **Delete**.

To save your changes and to close the window, click **OK** in the RADIUS Server window.

---

## Create RADIUS Server Window

This window appears when you click **Create** in the Configure RADIUS Server window. Use the window to specify the RADIUS server settings.

Follow these steps.

- 
- STEP 1** In the **IP Address** field, enter an IP address for the RADIUS server.
  - STEP 2** In the **Auth Port** field, enter the RADIUS authentication port number. The default authentication port number is 1812.
  - STEP 3** In the **Secret Key (ASCII)** field, enter the shared secret that the WLAN controller will use to communicate with the RADIUS server.
  - STEP 4** In the **Confirm Secret** field, re-enter the shared secret.
  - STEP 5** From the **Server Priority Key** list, select the server priority.
- NOTE** Each RADIUS server must use a different priority number.
- STEP 6** From the **Admin Status** list, select Enabled or Disabled.
  - STEP 7** Click **OK** to save your changes and to close the window.
- 

## Modify RADIUS Server Window

This window appears when you click **Modify** in the Configure RADIUS Server window. Use the window to change the status of a RADIUS server.

Follow these steps:

- 
- STEP 1** From the **Admin Status** list, select Enabled or Disabled.
  - STEP 2** Click **OK** to save your change and to close the window.
-

# Security Features

This section covers configuration of these basic security features:

- **NAT (Network Address Translation)**
- **VPN Server**
- **Security Audit**
- **Firewall and DMZ**
- **Network Security Settings (CE520 Switches)**
- **SSL VPN**
- **Intrusion Prevention System (IPS)**
- **URL Filtering (SR500 Series)**

## NAT (Network Address Translation)

To enable or disable network address translation (NAT), choose **Configure > Security > NAT** from the feature bar.

From this window, you can:

- Enable or disable Network Address Translation (NAT)
- Configure port mapping
- Configure port forwarding

**NOTE:** The NAT window user interface and configuration settings are different, based on how IP addresses are assigned.

For information about NAT features and configuration settings, see the following sections:

- **Overview**

- **NAT Window (IP Addresses Assigned via DHCP)**
- **NAT Window (Static IP or PPPoE with Static IP)**

## Overview

When enabled on an interface, Network Address Translation (NAT) maps the private IP addresses on your LAN to a public network IP address from a group of registered public network IP addresses.

A valid, registered, globally unique, public IP address is required for accessing the Internet. An organization usually does not own enough public IP addresses to assign a unique public IP address to each client in the organization that needs Internet access. Without NAT, your pool of public IP addresses would be depleted. The internal structure of your LAN would also be displayed to any client on the public network. NAT allows you to use one public IP address to provide Internet access to many of the clients on your LAN.

Using Configuration Assistant, you map the single public IP address assigned to your WAN interface to multiple private IP addresses.

It is easier for an unauthorized client to attack your network if the client can determine the topology of your network by using your network IP addresses. NAT hides your private IP addresses from the Internet. If an attacker cannot guess the structure of your LAN by using the IP addresses, then it is more difficult to break into your network.

In some cases—for example, when you configure a UC500 with a SIP trunk behind an SR500 secure router—NAT entries are created automatically by CCA.

**NOTE** NAT supports only Layer 3 Ethernet interfaces. It does not support Layer 2 switch port interfaces. When you enable NAT on an (untrusted) outside interface, all other qualified interfaces are automatically selected as (trusted) inside interfaces.

### Static NAT and Dynamic NAT

Static NAT works with the IP addresses statically mapped to each other. That is, the administrator can establish a one-to-one mapping between private IP addresses and public IP addresses. Static translations are generally used to allow access to a particular device through the NAT. For example, if a network has an internal DNS server which needs to communicate with an external DNS server, the administrator would configure a static translation to enable such connectivity. The NAT thus allows traffic to be passed between these statically known, but translated address.

Alternatively, Dynamic NAT maps private IP addresses to public IP addresses. Dynamic NAT uses a pool of public addresses and assigns them in a round-robin fashion (first-come, first-served basis). When a host with a private IP address requests access to the Internet, dynamic NAT chooses an IP address from the pool that is not already in use by another host. Dynamic NAT is useful when fewer addresses are available than the actual number of hosts to be translated.

## NAT Window (IP Addresses Assigned via DHCP)

First, choose a device on which you want to enable NAT from the **Hostname** list.

To enable NAT, choose an (untrusted) outside interface from the **Outside Interface** list. Click **Details** to view information about the selected outside interface.

To create an entry for each port mapping, follow these steps.

- 
- STEP 1** To add an entry to the NAT window, click **Add**.
- STEP 2** Choose an application from the Application field pull-down list:
- Web Server
  - Secure Web Server
  - Email Server
  - FTP
  - SSH
  - SFTP
  - Other (TCP)
  - Other (UDP)
- STEP 3** In the **Internal address** field, enter an IP address that the server uses on your internal network. This is an IP address that cannot be used externally on the Internet.
- STEP 4** In the **Internal Port** field, enter a port number for the inside device, which is the port number used by the server to accept service requests from the internal network.
- STEP 5** In the **External Port** field, enter a port number that NAT is to use for this translation. The port number is used by the server to accept service requests from the Internet.

---

To increase security, by adding a firewall, click **Firewall Service** and use the Firewall window. See **Firewall, page 250** for these settings.

**STEP 6** Click **Apply** or **OK**.

---

To delete a port mapping entry, follow these steps.

---

**STEP 1** Choose an entry in the window.

**STEP 2** Click **Delete**.

**STEP 3** To close the window and save your changes, click **OK**.

---

You can delete NAT settings for a device that is behind another NAT device on a fully routed network. For example, when a UC500 is connected behind an SR500 Series Secure Router, you can delete the NAT settings on the UC500.

To delete the entire NAT configuration, follow these steps.

---

**STEP 1** Click **Delete NAT Settings**.

If there are entries in the IP table, a window is displayed that warns you that if you proceed, you will delete the NAT configuration settings. Click **OK** to close the popup dialog and continue.

**STEP 2** In the main NAT window, click **OK**.

---

## NAT Window (Static IP or PPPoE with Static IP)

IP Static NAT screen controls are enabled only when a static IP or PPPoE with static is assigned to the Internet Connection (WAN interface).

The NAT Pool must be provisioned first before adding entries to the Static NAT Mapping table.

- **Create NAT Pool**
- **Static NAT Mapping**

---

## Create NAT Pool

IP addresses for the NAT Pool are provided by the Internet Service Provider (ISP). Up to 10 NAT pool entries may be added.

Users cannot enter an IP address into the NAT Pool that is used by the WAN interface.

### Create a NAT Pool Entry

---

**STEP 1** To create a NAT Pool entry click on the **Create** button that is located next to the NAT Pool table. This will launch a new window labeled Create NAT Pool.

**STEP 2** Enter a name into the **Pool Name** field.

**STEP 3** Enter the IP Address, or click the **Specify Range of Addresses** and enter the range of IP Addresses.

**NOTE:** The network address used in the NAT Pool should be in the same subnet as that provided for the WAN interface.

**STEP 4** Next, click **OK**.

**STEP 5** After provisioning the NAT Pool click **Apply**, or **OK** to apply the configuration. This will install the NAT Pool and add the IP Addresses as a secondary IP to the WAN interface.

---

## Delete NAT Pool Entry

---

**STEP 1** To delete a NAT pool entry from the NAT Pool Table select the desired pool entry, then click the **Delete** button located next to the NAT Pool table.

This will delete all static NAT mappings that use the IP addresses configured for that pool.

**STEP 2** Next, click **Apply** or **OK**.

**NOTE:** IP Addresses used in one pool cannot be used in another. In addition, each Pool name must be unique.

---

## Static NAT Mapping

The following guidelines apply to creating static NAT mappings:

- Each IP address pair must be unique. If an internal or external IP address and port are used in one mapping, then the same IP address cannot be used to create another mapping that does not specify a port. For example, if internal port 192.168.10.10:80 is mapped to 171.71.236.176:80, you cannot also map 192.168.10.10 to 171.71.236.175 or 192.168.10.15 to 171.71.236.176
- A NAT mapping can consist of an IP address by itself or an IP address with a port number. Well-known TCP/UDP port numbers are shown in the Internal/External Port field. You can enter a port number if one is not shown.
- An internal or external IP address and port that is used for one mapping cannot be used in mapped to any other IP address or port. For example, if internal port 192.168.10.10:80 is mapped to external port 171.71.236.178:80, you cannot also map 192.168.10.10:80 to 171.71.236.176:80 or 192.168.10.15:80 to 171.71.236.178:80
- You cannot create a static mapping using the WAN IP address alone, but you can create a mapping using the WAN IP address with a port.

---

**STEP 1** To provision Static NAT Mapping click the **Create** button that is located next to the Static NAT Mapping table.

**STEP 2** Map the internal and external IP addresses:

- a. Enter the desired internal IP address into the **Internal IP** field.
- b. Enter the externally registered IP address into the **External IP** field.

**STEP 3** Click **OK**. This will return you to the main NAT window.

**STEP 4** Click **Apply** or **OK**.

---



## VPN Server

To configure VPN server settings, choose **Configure** > **Security** > **VPN** from the feature bar.

**CAUTION**

Cisco does not recommend that you configure the VPN server over a remote WAN connection. If the connection to the WAN is interrupted, the operation will fail and the system may become unusable.

### Overview

A Virtual Private Network (VPN) allows a remote client access to the corporate network.

VPN is required in these circumstances:

- You need access to the SBCS network from a remote computer outside your network firewall.
- You want to use CCA to manage a remote SBCS device across the Internet.

You can authorize a remote VPN device to receive IPsec policies sent by a VPN server. You can also configure a VPN server to send IPsec policies to a remote VPN device.

When you authorize remote VPN clients to receive policies from a VPN server, end users can request a connection to their corporate network through a VPN tunnel by entering a password. When a connection is requested and the remote end user is authenticated, a VPN server forwards the parameters to the remote client. Otherwise, the user must manually enter the IPsec parameters to configure the VPN tunnel. Remote VPN devices include Cisco IOS routers, Cisco adaptive security appliances, and Cisco VPN clients.

A VPN *group* is a group of VPN clients that share the same authentication information and configuration. Pre-shared keys or digital certificates are used for authenticating the client against a group. The group policies can be configured on the local router database or on an external server such as RADIUS or both, a local and an external server.

You can configure a pre-shared key that authenticates a remote client. The pre-shared key adds to the security of the communications between the remote device receiving the IPsec policies and a server. The pre-shared key on the remote device must match the pre-shared key on the VPN server.

**NOTE** The maximum number of simultaneous VPN connections allowed by CCA for UC520 and UC540 platforms is 10. For UC560 platforms, up to 20 simultaneous VPN connections are allowed. VPN connections used for EZVPN, SSL VPN, Multisite Manager, and SPA525G phone VPNs are included in this total.

### **Network Access — VPN Tunnel**

Internet Access can be accomplished through the VPN tunnel. The security of the connection is greater, because you have VPN protection between the client and the server. Internet-related data moves through the tunnel to the server, where communications with the Internet takes place, providing the protections configured on the client and the server. This is in comparison to Split Tunneling, where Internet communications are sent and received outside the VPN tunnel, relying only on the protections configured on the client.

### **Internet Access — Split Tunneling**

When you enable split tunneling on a remote network, client communications with local devices or over the Internet with other networks are unencrypted. The data is only encrypted when the end user is communicating with a protected subnetwork; typically the corporate network. This reduces device processing time and increases network performance.

For example, a teleworker uses a VPN client PC to access the corporate network through a router that provides connectivity from the teleworker location through the Internet to the corporate network by using a VPN tunnel. However, there might also be other PCs at the teleworker location that are not part of the corporate network and should not be allowed into the VPN. Typical examples would be PCs used by the spouse or children of the teleworker. These PCs do need Internet access, and users are likely to use the teleworker router to avoid installing a second broadband connection in the same home. The IPsec tunnel can be up at all times and use IEEE 802.1x to authenticate corporate users who try to gain access from the remote site. A RADIUS server at the corporate headquarters site holds the database of corporate users. As the tunnel is always available, the remote router can query the database to confirm the 802.1x credentials (username and password) of the teleworker to allow the teleworker access to the VPN, yet exclude all others.

**CAUTION** Split tunneling can potentially pose a security risk when configured. Because VPN clients have unsecured access to the Internet, the VPN clients can be compromised by an attacker. That attacker might then be able to access the corporate LAN through the IPsec tunnel by using the identity of the VPN client.

## Procedures

Begin by selecting a device to be configured from the **Hostname** list.

Configure settings on each of these tabs in the VPN Server window:

- **Server Settings**
- **User Accounts**
- **Network Access**
- **VPN Profile**

## Server Settings

To enable a VPN server, configure VPN server policies and settings as described in the following table.

Once you are finished configuring server settings, click **Apply** to apply your settings, click **OK** to exit the VPN Server window, or click the User Accounts or Network Access tabs to continue configuring VPN settings.

Setting	Description
<b>VPN Server Interface(s)</b>	Select or view VPN Server interfaces. If only one interface is displayed, this setting is read-only.
<b>VPN Group</b>	
Configure VPN group settings. A VPN <i>group</i> is a group of VPN clients that share the same authentication information and configuration.	
<b>VPN Group Name</b>	Read-only field. The default VPN group name used by Configuration Assistant is EZVPN_GROUP_1.
<b>Maximum Connections</b>	Maximum number of VPN group clients that can be connected to the VPN server.
<b>Preshared Keys</b>	Enter the pre-shared key for authenticating VPN clients and remote VPN devices, then re-enter the key for confirmation.  The preshared key can contain from 8 to 127 alphanumeric characters. Spaces and the question mark (?) characters are not allowed.

Setting	Description
<b>VPN Remote IP Range</b>	Enter a starting IP address and an ending IP address to specify a range of IP addresses from which an available IP address is assigned to a user. Up to 10 IP addresses can be specified for UC520 or UC540 platforms; up to 20 IP addresses can be specified for UC560 platforms.
<b>DNS</b>	
<b>Primary DNS</b>	Enter the IP address of the primary DNS server for the VPN server.
<b>Secondary DNS</b>	Optional. Enter the IP address of the secondary DNS server for the VPN server.

To delete a VPN server, follow these steps:

**STEP 1** Click **Delete**.

A window appears, warning you that if you proceed, you will delete the VPN server configuration settings.

**STEP 2** To delete the VPN server and close the window, click **Yes**.

**STEP 3** To save your changes and to close the window, click **OK**.

### User Accounts

To create a user account and set a password for users requesting a connection through a VPN tunnel, click **Create**, and use the **Add an Account** window. See [Add an Account, page 248](#).

To delete a user account, select the user account, and click **Delete**.

---

## Network Access

To enable Internet access through the VPN tunnel for a remote site, check the **Enable Internet access on remote site** checkbox.

If you enable Internet access through the VPN tunnel, Split Tunneling is disabled.

To enable split tunneling and to identify the networks protected by encryption, follow these steps:

---

**STEP 1** Check the **Enable Split Tunneling** check box.

Only the traffic destined for the protected subnet is encrypted and sent through the VPN tunnel to the home network. All other traffic is sent to the destination subnets, but it is not encrypted, and it is not protected by a VPN tunnel.

**STEP 2** Click **Create**, and use the **Add a Network** window (see [Add a Network, page 248](#)).

---

To delete a protected subnet, follow these steps:

---

**STEP 1** Choose the network and the mask.

**STEP 2** Click **Delete**.

---

## VPN Profile

From the VPN Profile tab, you can export a Profile Configuration File (PCF) that your VPN users can import into the Cisco EZVPN client to create a new connection.

In order to be able to do this, the UC500 must have a static WAN IP address.

To export a PCF file, click **Export VPN Profile**. The Export VPN Profile option is disabled if you have not configured VPN server settings. Save the .pcf file to your local machine and distribute the file to your VPN users.

### VPN Profile Import Instructions

Your VPN users will follow these steps to import the PCF file into the Cisco EZVPN client.

- 
- STEP 1** If needed, download and install the Cisco EZVPN client from Cisco.com at [www.cisco.com/go/vpnclient](http://www.cisco.com/go/vpnclient).
  - STEP 2** Start the Cisco EZVPN client.
  - STEP 3** In the VPN client, click the Import icon or choose **Connection > Import** from the menu bar and browse to the location of the PCF file on the local machine. The profile will appear as a new connection entry.
  - STEP 4** To use the profile, double-click on the new connection entry and enter your VPN account username and password.
- 

## VPN Remote

To access VPN Remote configuration, choose **Configure > Security > VPN Remote** from the feature bar.

**NOTE** On Model SR520-T1 secure routers, VPN Remote is a licensed feature. To legally use this security feature, you must purchase the FL-SR520-T1-SEC Security Feature License for the SR520-T1. Contact your Cisco distributor to purchase this license.

To enable VPN remote client services on an SR500 secure router, follow these steps:

- 
- STEP 1** Begin by selecting the device to be configured from the **Hostname** list.
  - STEP 2** To enable voice services, check the **Enable Voice Services on Remote Connection** check box.
  - STEP 3** In the **IP PBX Address** field, enter the CME (Cisco Unified Communications Manager Express) IP address. For the UC500, the default value is 10.1.1.1.
  - STEP 4** In the **VPN Server** field, enter the IP address or the hostname of the VPN server or concentrator.

- 
- STEP 5** *Optional.* In the **Enter new preshared key** field, enter a pre-shared key to authenticate encrypted tunnels.

The pre-shared key must have at least 8 alphanumeric characters and can contain up to 127 characters. Spaces and the question mark (?) characters are not allowed. If a pre-shared key is configured on the remote VPN device, it must match the pre-shared key configured on a VPN server.

- STEP 6** In the **Reenter new preshared key** field, enter the preshared key.

- STEP 7** To save your changes and to close the window, click **OK**.

---

To delete the remote device authorization to receive IPSec policies, follow these steps.

- 
- STEP 1** Click **Delete**.

A window appears, warning you that if you proceed, you will delete the VPN remote configuration settings.

- STEP 2** To save your changes and to close the window, click **OK**.

---

### Establishing a VPN Tunnel (End User Client Connection Instructions)

These instructions describe how an end user connected to a service provider using a Cisco SR520 router can establish a VPN tunnel to a central site network. These instructions are provided for the convenience of a system administrator.

To establish a VPN tunnel between a remote user and a central site network, follow these steps.

- 
- STEP 1** Launch a Web browser window, such as Internet Explorer.

- STEP 2** Enter the IP address of the VPN server in the **Address** field of the browser. The VPN tunnel Activation Tool window appears, providing the option to connect to a central site network by using VPN or to connect to the Internet.

- STEP 3** To connect to the central site network, click **Connect Now**. The Authentication for VPN tunnel Activation window appears.

- STEP 4** Click **Continue**. The VPN tunnel is established.
-

---

## Add a Network

This window appears when Split Tunneling is enabled and you click **Create** on the Network Access tab in the VPN Server window or the SSL VPN window.

Use this window to add the subnetworks for which the packets are tunneled from the VPN or SSL VPN clients. Only traffic destined for these subnetworks are sent through the VPN or SSL VPN tunnel. All other traffic from client connections is sent unencrypted. For more information, see [Internet Access — Split Tunneling, page 242](#).

To add a network, follow these steps:

- 
- STEP 1** In the **Network** field, enter the network IP address.
  - STEP 2** In the **Wildcard Mask** field, choose a subnet mask.
  - STEP 3** Continue adding subnetworks for which you want to permit VPN or SSL VPN access.
  - STEP 4** To close the window, click **OK**.
- 

## Add an Account

This window appears when you click **Create** on the User Accounts tab on the VPN Server window.

Use this window to add user authentication details to the local database.

To add an account, follow these steps:

- 
- STEP 1** In the **Username** field, enter the username. The username can contain up to 64 alphanumeric characters. These characters are not allowed: (space), +, #, %, /, \, ?, ;, <, >, {, }, |, ^, ~, [, ], ` , and ".  
  
The administrator account is automatically enabled as a VPN user.  
  
The default VPN user account cannot be deleted.
  - STEP 2** Enter the password in the **Password** field and again in the **Confirm Password** field. The password can contain up to 25 alphanumeric characters. The minimum length of a password is 6 characters. These characters are not allowed: (space), +, /, \, <, >, #, %, {, }, |, ^, ~, [, ], ` , and ".



**STEP 3** To close the window, click **OK**.

---

## Firewall and DMZ

To configure Firewall and DMZ settings, choose **Configure > Security > Firewall and DMZ** from the feature bar.



### CAUTION

Cisco does not recommend that you configure Firewall and DMZ settings over a remote WAN connection. If the connection to the WAN is interrupted, the operation will fail and the system may become unusable.

---

### Overview

You can increase your network security by configuring a firewall and a Demilitarized Zone (DMZ) to protect your LAN.

- If you are configuring a UC520, you are using a CBAC Firewall.
- If you are configuring a SR520 you are using a Zone-based Firewall.

CBAC firewall policy is defined by applying static Access-Control List (ACL) configuration on router interfaces to define the types of traffic allowed through an interface.

Zone-Based Policy Firewall changes the Cisco IOS Stateful Inspection model to a zone-based configuration model where router interfaces are assigned to security zones, and firewall inspection policy is applied to traffic moving between the zones. (See the “Conceptual Difference Between Cisco IOS Classic and Zone-Based Firewalls” white paper, available on Cisco.com, for more information.)

Manage the security of your network by performing these tasks:

- Configure a firewall to filter packets arriving at the router, based on the security level you choose. If a packet meets the criteria, it is allowed to pass through the interface or the zone. If a packet does not meet the criteria specified by the security parameters, the packet is dropped.
- Create a DMZ on which to place public access servers so that they will be on a separate, isolated network. This provides extra security for your internal network. The DMZ can be used for public access to the Web and

for Web access to your servers that are accessible from the Internet. To create a DMZ you must first create a firewall.

### Procedures

Choose a device on which you want to enable a firewall (and optionally a demilitarized zone) from the **Hostname** list.

This window has two tabs:

- [Firewall, page 250](#)
- [DMZ, page 252](#)

From this window you can also click **NAT Service** to open the NAT window to configure network address translations. See [NAT Window \(IP Addresses Assigned via DHCP\), page 237](#).

### Firewall

You follow the same procedure to create or to modify a firewall. Follow these steps:

- 
- STEP 1** Choose an outside interface from the **Outside (untrusted) Interface/Zone** list, or check an inside interface on the **Inside (trusted) Interface/Zone** list. Outside interfaces connect to your WAN or to the Internet. Inside interfaces connect to your LAN. These guidelines apply:
- If you choose an outside interface, the **Inside (trusted) Interface/Zone** is shown in gray.
  - You can select multiple inside interfaces.
  - Do not select the interface through which you accessed Cisco Configuration Assistant as the outside (untrusted) interface.
  - You cannot launch Cisco Configuration Assistant through the firewall from the outside (untrusted) interface.
  - If you select an outside interface that is already selected as an inside interface or DMZ interface, a warning message appears.
  - If you select an inside interface that is already selected as a DMZ interface, a warning message appears.

**STEP 2** Move the **Security Level** slider to the level that you want. The Security Level slider is enabled when you select an interface. The **Description** area lists the filtering rules for each of these security levels:

- **High** prevents the use of instant messaging and point-to-point applications on the network. The firewall monitors HTTP and email traffic and drops traffic that does not comply with the security protocol. It returns other TCP (Transmission Control Protocol) and UDP (User Datagram Protocol) traffic for sessions started inside the firewall.
- **Medium** monitors the use of instant messaging and point-to-point applications, and HTTP and email traffic. The firewall returns other TCP and UDP traffic for sessions started inside the firewall.
- **Low** does not monitor application traffic. The firewall returns other TCP and UDP traffic for sessions started inside the firewall.

**STEP 3** In the **DNS Primary** field, enter the primary DNS (Domain Name Service) server IP address. These restrictions apply:

- If DNS was configured through another means, the DNS IP addresses cannot be configured. To modify the DNS configuration, use the **Device Configuration** tab in the **Configure > Device Properties > IP Addresses** window.
- If a DNS is already configured on the device, the DNS IP address appears and you cannot enter DNS IP address.
- If the Security Level slider is set to medium or high and DNS is not configured on the device, a DNS primary IP address is required.

**STEP 4** *Optional.* In the **DNS Secondary** field, enter the secondary DNS server IP address.

---

## DMZ

To create a DMZ, follow these steps:

- 
- STEP 1** From the **DMZ Interface** menu, choose an interface.
- If the interface that you choose is an outside interface or an inside interface that is also identified as the interface for the firewall, a warning dialog appears.
- STEP 2** Click **Create**, and use the Create DMZ Service window. See [Create DMZ Service, page 252](#).
- STEP 3** To close the window and to save your changes, click **OK**.
- 

To delete a DMZ, follow these steps:

- 
- STEP 1** Select the IP address.
- STEP 2** Click **Delete**. A confirmation window appears.
- STEP 3** To close the window, click **Yes**.
- STEP 4** To close the window and to save your changes, click **OK** on the Firewall and DMZ window.
- 

## Create DMZ Service

This window appears when you click **Create** on the DMZ tab of the Firewall and DMZ window.

Use this dialog to add a demilitarized zone (DMZ) to an interface. You must first configure a firewall.

Follow these steps:

- 
- STEP 1** To determine where traffic for the specified TCP or UDP service will be directed, enter an IP address in the **IP Address** field. If NAT (Network Address Translation) is enabled, enter the NAT-translated address, also known as the inside global address.

**STEP 2** From the **Server Type** list, choose the supported server type. The supported server types are **FTP**, **Web Server**, **Secure Web Server**, **Mail Server**, **SSH**, and **SFTP**.

**STEP 3** To close the window, click **OK**.

---

## Firewall—Edit ACL

The Firewall—Edit ACL window is displayed when:

- Firewall is enabled on the UC500.
- Custom ACEs (access control entries) were configured out-of-band using the IOS command-line interface.
- Configuration Assistant detects the out-of-band configuration when trying to apply voice configuration.

Use the **Move Up** and **Move Down** controls in the window to re-order the entries in the access control list (ACL) as needed, then click **OK**.

## Security Audit

To perform a security audit, choose **Configure > Security > Security Audit** from the feature bar.

### Overview

You can test the security policies and enable security procedures to ensure secure networking services on your network. By auditing your router security configuration, you can test for the critical security functionality on your router configuration to determine whether potential security problems exist. You can choose to accept or reject the recommended security settings.

These conditions are checked. You can change the settings as needed to adjust the security of your network:

- Disable the finger service
- Disable the PAD service
- Disable the TCP small servers service

- Disable the UDP small servers service
- Disable the IP BOOTP server service
- Disable the IP identification service
- Disable IP source route
- Enable the password encryption service
- Enable TCP keepalives for inbound Telnet sessions
- Enable TCP keepalives for outbound Telnet sessions
- Enable sequence numbers and timestamps on debugs
- Enable IP CEF (Cisco Express Forwarding)
- Disable IP gratuitous ARPs
- Set the minimum password length to less than six characters
- Set the authentication failure rate to less than three retries
- Set the TCP sync wait time
- Enable logging
- Disable SNMP
- Set a scheduler allocation
- Disable the IP redirects
- Disable IP Proxy ARP
- Disable IP directed broadcast
- Disable the MOP (Maintenance Operation Protocol) service
- Disable the IP unreachablees
- Disable the IP mask reply
- Disable the IP unreachablees on a null interface
- Enable unicast RPF on the outside interfaces
- Enable AAA

---

### Procedures

To run a security audit on a device, follow these steps:

- 
- STEP 1** Choose **Security Audit** from the **Security** list to display the Security Audit launch button.
  - STEP 2** From the **Hostname** list, choose the device to audit.
  - STEP 3** To display a list of the security audit settings and the recommended actions, click **Security Audit**. The Security Audit Report window appears.
  - STEP 4** Use this window to choose which actions to perform to secure your network.

The table shows which security settings are set to the recommended values and which settings are not. Those that are not set to the recommended values represent a potential security problem.

---

To modify the security configuration of a device, follow these steps:

- 
- STEP 1** Choose a device to be audited from the **Hostname** list.
  - STEP 2** To configure the recommended security settings for parameters that are not set to the recommended values, click the **Fix security problems** radio button. To set the security feature to the default value, click the **Undo security settings** button.
  - STEP 3** To set the security features to the recommended values, check boxes in the **Fix** column next to the security settings that did not pass the security audit.
  - STEP 4** To set the security features to the default values, in the **Undo** column beside the security settings that passed, check the check boxes. To choose all of the check boxes, check **Select All**.
  - STEP 5** To put your security changes into effect and to close the window, click **OK**.
- 

## Network Security Settings (CE520 Switches)

If one or more Catalyst Express CE520 switches are present in the customer site, select a security level for these switches by choosing **Configure > Security > Network Security Settings**.

## Overview

You must set all the Catalyst Express switches in your network at the same security level: low, medium, or high. The levels are defined as follows:

- **Low.** Broadcast storm control and control over the number of users who can access a port.
- **Medium.** Low settings plus a table for authorizing the MAC addresses that can access a port.
- **High.** Low settings plus an identified RADIUS server for authorizing host devices that want access.

## Procedures

The Network Security Settings window appears when:

- The Event Notification window shows a conflict in network security settings and you click **Resolve**.
- You choose **Configure > Security > Network Security Settings** from the feature bar.

The contents of the window depend on whether you set the host access security level to Low, Medium, or High.

The Event Notification window directs you to this window for any of these reasons:

- Your Catalyst Express switches are not set at the same security level. To resolve the conflict, set the security level at Low, Medium, or High, and click OK.
- A MAC authentication table contains a MAC address that needs your approval. To perform this task, see Host Level: Medium.
- The RADIUS server configuration for your Catalyst Express switches is not identical. To resolve the conflict, see Host Level: High.

### Host Level: Low

At the Low level, Network Assistant uses these security features:

- Enable broadcast storm control for all Catalyst Express switches in the community.

Broadcast storm control prevents broadcast packets from flooding the subnet and degrading network performance. A severe broadcast storm can block all network traffic.



- Enable port security control for all Catalyst Express switches in the community.

Port security control limits the number of MAC addresses that can access a port at the same time. The maximum number of MAC addresses depends on the Smartports role that is configured on the port. This table shows how the maximum varies by Smartports role.

Smartports Role	Maximum Number of MAC Addresses
<b>desktop</b>	1
<b>iphone</b>	3 if a voice VLAN is configured; otherwise, 2
<b>access-point</b>	30
<b>switch</b>	No limit
<b>router</b>	No limit
<b>server</b>	1
<b>guest</b>	30
<b>diagnostic</b>	No limit
<b>other</b>	No limit

To learn more about the Smartports feature, see [Smartports, page 152](#).

#### Host Level: Medium

The Medium level adds a security feature called MAC authentication. This means that when a desktop, server, printer, IP phone, access point, switch, or router connects to the community through a Catalyst Express switch port, its MAC address must be explicitly added to the MAC authentication table before it is allowed to access the community.

You add a MAC address to the MAC authentication table when you:

- Connect a device to a port on a Catalyst Express switch.
- To approve the MAC address, you select yes in its Approved cell.
- Click **Add a MAC Address**, and use the Add a MAC Address window. See [Add a MAC Address, page 258](#).

A MAC address is always approved when added.

To change the approval of one or more MAC addresses, select them, click **Modify**, and use the Modify a MAC Address window. You can also change the approval of a single MAC address by editing its Approved cell. See [Modify a MAC Address, page 259](#).

To delete one or more MAC addresses, select them, and click **Delete**.

The MAC authentication tables on the Catalyst Express switches in your network must be identical. If they are not, you are prompted to resolve the conflict. You can ask Configuration Assistant to either merge the tables or clear them.

### Host Level: High

The High level configures 802.1x on Catalyst Express switches. 802.1x is an authentication protocol that requires hosts to provide their usernames and passwords to access the network. They are forwarded to a RADIUS server, where approved usernames and passwords are stored. You configure the RADIUS server in this window.

**NOTE** 802.1x authentication applies only to access requests from desktops.

When you use the High level, MAC authentication is no longer needed, so it is turned off.

To set up 802.1x authentication:

- 
- STEP 1** Enter the IP address of the RADIUS server.
  - STEP 2** Enter the RADIUS key that Catalyst Express switches will use to communicate with the RADIUS server.
  - STEP 3** Enter a UDP port from 0 to 65535 for RADIUS authorization. If you are running Cisco Secure ACS version 4.0 or later, 1645 is the default UDP port. For earlier versions, it is 1812.
- 

## Add a MAC Address

This window appears when you set the Network Security Settings window to the Medium security level and click **Add a Preapproved MAC Address**.

Enter a MAC address in the MAC Address field and click **OK**. The MAC address will appear in the Network Security Settings window with an approval status of yes.

---

## Modify a MAC Address

This window appears when you select one or more MAC addresses in the Network Security Settings window and click **Modify**.

If you selected a single MAC address, it appears in the window; if you selected more than one, you see MAC Address: Multiple.

In the Approve list, select yes or no, and click **OK**. The status of the selected MAC addresses is changed accordingly.

---

## SSL VPN

To access SSL VPN configuration, choose **Configure > Security > SSL VPN**. SSL VPN can be configured on Cisco SR500 Series Secure Routers.

To enable and configure SSL VPN, the router must have a static IP address.

**NOTE** For the model SR520-T1 secure router, SSL VPN is a licensed feature. To legally use this security feature, you must purchase the FL-SR520-T1-SEC Security Feature License for the SR520-T1. Contact your Cisco distributor to purchase this license.

**NOTE** SSL VPN for the Cisco SA500 Series Security Appliance is not configured through CCA. To configure SSL VPN on this device, use the SA500 Series Security Appliance Configuration Utility.

**CAUTION**

---

Cisco does not recommend that you configure SSL VPN over a remote WAN connection. If the connection to the WAN is interrupted, the operation will fail and the system may become unusable.

---

### Overview

SSL (Secure Sockets Layer) VPN (Virtual Private Network) provides remote access connectivity from almost any Internet-enabled location using a Web browser and its native SSL encryption.

The main role of SSL is to provide security for Web traffic. Security includes confidentiality, message integrity, and authentication. SSL achieves these elements of security through the use of cryptography, digital signatures, and certificates. Although application accessibility is constrained relative to IPsec VPNs, SSL-based VPNs allow access to a growing set of common software applications, Web-enabled services such as file access, email, and TCP-based applications (by way of a downloadable client).

### Basic Features

The SSL VPN configuration provided through CCA enables the best-practice default configuration wherever possible.

Using an SSL-enabled web browser (Internet Explorer, Netscape, or the equivalent), the user can establish a connection to the SSL VPN gateway. The initial user request to the SSL VPN gateway will be responded to with a user logon HTML page. The username and password are submitted to the gateway for authentication with a RADIUS server (Cisco ACS), and a session is only granted if the authentication is successful.

If a session is established, it is maintained by sending a session cookie to the user browser. This cookie must be embedded in all the following user HTTP requests for authentication at the SSL VPN gateway. If the cookie is missing or incorrect, the session is dropped, and the user can no longer access the corporate network. Normally, the session remains until the user logs out, the session times out, or the session is cleared from the SSL VPN gateway.

Basic SSL VPN configuration provides a clientless mode, with secure access to private web resources and web content. This mode is useful for providing access to content in a web browser, such as Internet access, databases, and online tools that employ a web interface.

When Basic SSL is configured, once the user is authenticated and a session is established, an SSL VPN portal page and toolbar is displayed on the user's web browser. From this page, the user can access all available HTTP sites, access web email, and browse Common Internet File System (CIFS) file servers.

**NOTE** If a popup blocker is enabled, it is possible that the small SSL VPN toolbar window is not displayed.

### Advanced Features

Advanced SSL VPN options provide SSL thin-client mode, and full-tunnel client mode.

- **Thin Client (port forwarding) Mode.** Thin client mode extends the capability of the cryptographic functions of the web browser to enable

remote access to TCP-based applications with static ports, such as Post Office Protocol version 3 (POP3), Simple Mail Transfer Protocol (SMTP), Internet Message Access protocol (IMAP), Telnet, and Secure Shell (SSH).

In thin client mode, the VPN user downloads a Java applet by clicking on the link provided in the portal page. The Java applet acts as a TCP proxy on the client machine for the services configured by security gateway administrator. The Thin client download assumes that the user who downloaded the applet has administrative privileges.

- **Full Tunnel Mode.** Full tunnel client mode offers extensive application support through its dynamically downloaded Cisco Anyconnect client or the Cisco SSL VPN Client (SVC). Full tunnel client mode delivers a lightweight, centrally configured and easy-to-support SSL VPN tunneling client that provides network layer access to virtually any application.

In full-tunnel client mode, an SSL tunnel is used to move data to and from the internal networks at the network (IP) layer. When the user logs into the SSL VPN gateway, the SSL VPN client is automatically downloaded and installed at the end user's PC, and the tunnel connection is established. Once the connection is established, the user has full VPN access to the corporate network. Using full tunnel mode it is also possible to have voice support.

When Full Tunnel mode is enabled, the SSL VPN Anyconnect client must be installed in order for the VPN to function.

**NOTE** The SSL VPN user must have administrative rights to install applications on their PC in order for automatic download and installation of the SSL VPN client to work.

A Cisco.com login is required to download the client. A link to this software download for this package is provided on the Advanced tab.

- **Split Tunneling.** When you enable split tunneling on a remote network, client communications with local devices or over the Internet with other networks are unencrypted. The data is only encrypted when the end user is communicating with a protected subnetwork, typically the corporate network. This reduces device processing time and increases network performance.

**CAUTION** Split tunneling can potentially pose a security risk when configured. Because SSL VPN clients have unsecured access to the Internet, the clients can be compromised by an attacker. That attacker might then be able to access the corporate LAN through the tunnel by using the identity of the client.

## Procedures

Begin by selecting a device to be configured from the **Hostname** list.

This window has two tabs:

- **Basic**
- **Advanced**

### Basic

On the Basic tab, configure settings as described in the following table, then click **OK** to close the window.

Setting	Description
<b>Digital Certificate</b>	Select the digital certificate that will be sent to the client for SSL authentication. If a digital certificate is not present, click <b>Generate Certificate</b> to generate one.
<b>IP Address</b>	This read-only field displays the configured static WAN IP address. This is the IP address that will be used to access the VPN portal.  <b>NOTE</b> To launch SSL VPN from the client PC, use the <code>https://ipaddress</code> format in the browser <b>Address</b> field (use https instead of http).
<b>Intranet Websites</b>	List of intranet Website to be displayed on the SSL VPN portal page.  To add an Intranet Website:  1. Click <b>Add</b> to insert a new row in the table.  2. Click in the <b>Label</b> field on the new row and enter a descriptive label using alphanumeric characters. The following characters are not allowed: +, #, %, /, \, ?, ;, <, >, {, },  , ^, ~, [, ], ` and ".  3. Click in the <b>URL</b> field and enter the URL for the Website. The following characters are not allowed: (space), +, ?, /, \, <, >, #, %, {, },  , ^, ~, [, ], ` and ".  To delete an Intranet Website, select the site in the list and click <b>Delete</b> .

Setting	Description
<b>User Accounts</b>	<p>List of user accounts for this SSL VPN.</p> <p>The administrator account is automatically enabled as a VPN user.</p> <p>The maximum number of user accounts is 10 for UC520 and UC540 platforms, and 20 for UC560 platforms.</p> <p><b>NOTE</b> The maximum number of simultaneous VPN connections allowed by CCA for UC520 and UC540 platforms is 10. For UC560 platforms, up to 20 simultaneous VPN connections are allowed. VPN connections used for EZVPN, SSL VPN, Multisite Manager, and SPA525G phone VPNs are included in this total.</p> <p>To add a user account and set a password for users requesting a connection through a VPN tunnel:</p> <ol style="list-style-type: none"> <li>1. Click <b>Add</b> to insert a new row in the table.</li> <li>2. Click in the <b>User Name</b> field on the new row and enter the user ID for the new account.</li> <li>3. Click in the <b>Password</b> field and enter the password for the user account. The following characters are not allowed: (space), +, ?, /, \, &lt;, &gt;, #, %, {, },  , ^, ~, [, ], ` , and " .</li> </ol> <p>To delete a user account, select the account in the list and click <b>Delete</b>.</p>

**Advanced**

On the Advanced tab, enable and configure advanced SSL VPN settings as described in the following table. When finished, click **OK** to close the window.

Setting	Description
<b>Thin Client</b>	Enable or disable Thin Client (port forwarding) mode for SSL VPN. When Thin Client is unchecked, clientless mode is used.
	<p><b>Configure Port Forwarding List</b></p> <p>When Thin Client is enabled, click <b>Configure Port Forwarding</b> to enable remote access to TCP-based applications such as email, Telnet, and SSH with static ports.</p> <p>Complete the settings in the Port Forwarding window, as described in <a href="#">Configure Port Forwarding List, page 266</a>.</p>
<b>Full Tunnel</b>	<p>Enable or disable Full Tunnel mode for SSL VPN.</p> <p>Full tunnel mode delivers a lightweight SSL VPN tunneling client that provides network layer access to virtually any application. The client is automatically downloaded and installed to the client PC.</p> <p>For Full Tunnel mode, the SSL VPN client must be installed.</p> <p>The VPN user must have administrative rights to install applications on their PC for automatic download and installation of the SSL VPN client to work.</p> <p>When Full Tunnel mode is enabled, specify a range of IP addresses for clients to use when they connect.</p>
	<p><b>Starting IP</b></p> <p>Enter the first IP address in the range.</p>
	<p><b>Ending IP</b></p> <p>Enter the last IP address in the range.</p>



Setting	Description
<b>SSL VPN Client</b>	<p>When the Full Tunnel client is enabled, the <b>Install</b> and <b>Uninstall</b> options become active.</p> <p><b>IMPORTANT</b> When Full Tunnel mode is enabled, the SSL VPN client installation is required. If the client is not installed, an error message is displayed to users.</p> <p>The Install option allows you to install SSL VPN client software (Cisco Anyconnect client Web deployment package on SR520-T1 secure routers or SSL VPN Client (SVC) on SR520-ADSL/Ethernet secure routers).</p>
<b>Install</b>	<p>To install SSL VPN client software, click <b>Install</b>, click <b>Browse</b> to navigate to the location of the file, then click <b>OK</b>.</p> <p>CCA supports the current Web deployment package for Windows. A link to the download location for this package is provided when you click <b>Install</b>. A Cisco.com login is required for downloading this software. See <b>Install SSL VPN Client Software Window, page 268</b> for instructions.</p>
<b>Uninstall</b>	<p>To uninstall the SSL VPN client software from the router, click <b>Uninstall</b>.</p>
<b>Keep client software installed on the client PC</b>	<p>Check <b>Keep client software installed on the client PC</b> to leave the client software on the user's PC so that it does not have to be downloaded and installed each time the user connects to the SSL VPN.</p> <p><b>TIP</b> Disable this option if you are using SSL VPN for third-party remote access, and you do not want to leave a copy of the client on external PCs.</p>

Setting	Description	
<b>Split Tunneling</b>	<b>Enable split tunneling</b>	<p>Check this option to enable split tunneling. Only the traffic destined for the protected subnet is encrypted and sent through the SSL VPN tunnel to the home network. All other traffic is sent to the destination subnets, but it is not encrypted, and it is not protected by a SSL VPN tunnel.</p> <p>Click <b>Add</b> to specify local subnets for SSL VPN traffic. See <a href="#">Add a Network, page 248</a> for a description of fields in this dialog.</p> <p>To remove a subnet from the list, highlight the subnet entry in the list and click <b>Remove</b>.</p>

## Configure Port Forwarding List

The Port Forward window appears when you click **Configure Port Forwarding List** in the SSL VPN window.

### Overview

When port forwarding is enabled, the hosts file on the SSL VPN client is modified to map the application to the port number configured in the forwarding list. A Port Forwarding List object defines the mappings of port numbers on the remote client to the application's IP address and port behind the SSL VPN gateway.

### Procedures

To add an entry to the Port Forwarding list for each server and port mapping, click **Add**, configure the settings for each entry as described below, then click **OK** to close the window and save your settings.

Setting	Description
<b>Server IP</b>	Enter an IP address that the server uses. This is an IP address that cannot be used externally on the Internet.
<b>Server Port</b>	Specify the port number of the application for which port forwarding is configured (between 1 and 65535). The service port must be a static port.

Setting	Description
<b>Client Port</b>	Specify the port number of the client port (between 1 and 65535). The port must be a static port.
<b>Description</b>	Add information about the port forwarding entry (up to 1024 characters). This information is mandatory on Cisco IOS routers.

To delete a forwarding port mapping, follow these steps:

- STEP 1** Choose an entry in the window.
- STEP 2** Click **Delete**.
- STEP 3** Click **OK** to save your changes and close the window.

## Add a User Account

This window appears when you click **Add** from the User Accounts tab on the SSL VPN window.

To add a user account, configure the settings as described below, then click **OK** to save your changes and close the window.

**NOTE** The administrator account is automatically enabled as an SSL VPN user account and it cannot be deleted.

Setting	Description
<b>Username</b>	The username can contain up to 64 alphanumeric characters. The following characters are not allowed: (space), +, #, %, /, \, ?, ;, <, >, {, },  , ^, ~, [, ], ` , and " .
<b>Password</b>	The password can contain up to 25 alphanumeric characters. The minimum length of a password is 6 characters. The following characters are not allowed: (space), +, ?, /, \, <, >, #, %, {, },  , ^, ~, [, ], ` , and " .
<b>Confirm Password</b>	Re-enter the password for confirmation.

## Add Intranet Websites

This window appears when you click **Add** (Intranet Websites) on the SSL VPN window.

To add a URL, configure the settings as described below, then click **OK** to save your changes and close the window.

Setting	Description
<b>URL Label</b>	Enter a description of the UR using alphanumeric characters. The following characters are not allowed: +, #, %, /, \, ?, ;, <, >, {, },  , ^, ~, [, ], ` , and " .
<b>URL</b>	Enter the URL. The following characters are not allowed: (space), +, ?, /, \, <, >, #, %, {, },  , ^, ~, [, ], ` , and " .

## Install SSL VPN Client Software Window

This window appears when you click **Install (SSL VPN Client Software)** on the SSL VPN window.

Use this window to install SSL VPN client software on the client device. You can also use this window to download the latest version of the SSL VPN Client software. A Cisco.com login is required for downloading the SSL VPN client software.

To install SSL VPN client software on the client device, follow these steps.

- 
- STEP 1** If needed, download the SSL VPN Client (SVC) or Cisco Anyconnect Web deployment .pkg file from Cisco.com using the link provided. This link points to the currently supported Microsoft Windows client package.
- If the UC500 8.1.0 software pack is installed on your system, you must use version 2.5.1025 of the Anyconnect Microsoft client package (win-2.5.1025-k9.pkg). Version 2.3.0254 of the Anyconnect client is incompatible with the version of Cisco IOS contained in UC500 software pack 8.1.0.
- STEP 2** Click **Browse** and navigate to the location of the SSL VPN Client or Anyconnect software package on your local PC.
- STEP 3** Select the SSL VPN Client .pkg file.

---

**STEP 4** Click **OK**. to install the package and return to the SSL VPN window.

---

## Intrusion Prevention System (IPS)

To configure IPS on SR500 Series Secure Routers, choose **Configure > Security > IPS** from the feature bar.

**NOTE** For the model SR520-T1 secure router, IPS is a licensed feature. To legally use this security feature, you must purchase the FL-SR520-T1-SEC Security Feature License for the SR520-T1. Contact your Cisco distributor to purchase this license.

### Overview

An intrusion prevention system, monitors network and/or system activities for malicious or unwanted behavior and can react, in real-time, to block or prevent those activities.

A network-based IPS operates in-line to monitor all network traffic for malicious code or attacks. When an attack is detected, offending packets are dropped, but all other traffic is allowed to pass. Unlike traditional firewalls, an IPS makes access control decisions based on application content, rather than IP address or ports.

Cisco IOS Intrusion Prevention System (IPS) is an inline, deep-packet inspection feature that effectively mitigates a wide range of network attacks and supports the following features:

- IPS can be configured for inside and outside interfaces that are considered vulnerable to attacks.
- Once IPS interfaces are configured, you must obtain a public key and import an IPS signature package (Signature Definition File or SDF). IPS signature updates are supported for SDM-IPS package files only.
- Signature package updates can be imported after the initial configuration.
- IPS Alerts are provided to notify users of attacks and alerts, risk levels, and actions taken.

**NOTE** Signature editing, IPS security dashboard, and IPS monitoring features are not supported.

## Procedures

Refer to the following topics to configure IPS features:

- [Initial IPS Configuration, page 270](#)
- [IPS Signature Updates, page 271](#)
- [IPS Alerts, page 272](#)
- [Deleting IPS Configuration, page 272](#)

### Initial IPS Configuration

The initial IPS configuration requires you to choose a device on which to enable IPS, choose interfaces for packet scanning, obtain a public key, download a signature package, and install the signature definition file from the package on the router.

To configure IPS, follow these steps.

---

**STEP 1** Choose a device on which you want to enable IPS from the **Hostname** list.

**STEP 2** Configure the interfaces.

To configure interfaces for IPS, choose an outside interface from the **Outside (untrusted) Interface/Zone** list or an inside interface on the **Inside (trusted) Interface/Zone** list. Available interfaces detected on the router are listed in the Inside and Outside columns of the table.

The terms *outside* and *inside* refer to the direction for IPS packet scanning for attacks on the interface (incoming or outgoing packet flow).

- When IPS is selected for an interface listed in the **Outside** column of the table, IPS scans only outgoing packets on that interface.
- Similarly, when IPS is selected for an interface listed in the **Inside** column of the table, IPS scans only incoming packets on that interface.
- The same interfaces can be configured as both inside and outside interfaces.

You can enable IPS scanning on an interface's outgoing and/or incoming packet flow, and there is no limit on the number of interfaces for which IPS can be enabled.

**STEP 3** Download a public key.

After you have configured the inside and outside interfaces, click on the link provided to download a public key from Cisco.com. Then, copy and paste the **key-string** section of the key into the text area provided for the key.

The public key is required and is named **realm-cisco.pub**.

**STEP 4** Download and install a signature package.

You will need to provide your Cisco.com user account login and password for authentication.

To download and install an IPS signature package:

- a. Click **Install SDF** to open the Download Signature Package dialog with a link for downloading an SDM-IPS Signature Definition File (SDF) package.
- b. Click the download link to go to Cisco.com and choose a Cisco IOS SDM-IPS signature package from the list of SDM-IPS signature packages.

Only SDM-IPS packages in the Basic category are supported for use with the SR520. The Basic category supports signature files up to 128 MB in size and is intended for routers with up to 128 MB of memory.

- c. Browse to the location of the signature package file (.zip file) on the local PC.
- d. Click **OK** or **Apply**.

When you click **OK** or **Apply**, the configuration is sent to the router. All IPS-related configuration files are placed in the following location: flash:/ips/

Once you have installed the signature package, the **Delete IPS Configuration** button, **IPS Signature Updates** tab, and **IPS Alerts** tabs become active.

---

### IPS Signature Updates

IPS signature updates are only available if IPS was successfully configured and a signature package was downloaded.

IPS signature updates are supported for SDM-IPS package files only. From the IPS Signature Updates tab, you can import new and updated signatures for a selected SDF package.

---

To import IPS signature updates, follow these steps.

- 
- STEP 1** In the IPS window, click the IPS Signature Updates tab.
  - STEP 2** Click on the link to go to Cisco.com and choose an IPS-SDM .sdf package file to download.
  - STEP 3** Browse to the location of the SDF package file (.zip file) on the local PC.
  - STEP 4** Click **Extract Signatures** to display new and updated signatures as well as signatures that are deployed to the router, but are currently disabled.
  - STEP 5** Click **OK** to upload the signatures displayed in the table to the router and update the SDF package version on the router.
- 

### IPS Alerts

The IPS Alerts section displays intrusion detection alerts and actions taken, along with information about the alert. The following information is displayed for each alert:

- Signature ID and description of the attack
- Risk rating
- Event action
- Source and destination IP addresses for the attack
- Number of hits and dropped packet counts

Click **Show Alerts** to view the current list of alerts; click **Clear Alerts** to clear the list.

### Deleting IPS Configuration

To delete the current IPS configuration, click **Delete IPS Configuration**, then choose **OK** or **Apply**.



## URL Filtering (SR500 Series)

To configure URL Filtering on Cisco SR500 Series Secure Routers, choose **Configure > Security > URL Filtering**.

Zone Based Firewall (ZBF) configuration must be enabled before you can enable URL filtering.

**NOTE** For the model SR520-T1 secure router, URL Filtering is a licensed feature. To legally use this security feature, you must purchase the FL-SR520-T1-SEC Security Feature License for the SR520-T1. Contact your Cisco distributor to purchase this license.

### Overview

URL filtering allows you to control access to Internet websites by permitting or denying access to specific websites based on a URL list. You can maintain a local URL list on the router.

CCA supports Black/White lists only (C3PL URL filtering). A Black/White list is a list of URLs that is manually created and maintained by the network security staff for a business. There are no default URLs; it is user-defined. CCA does not currently support use of third-party servers for URL filtering.

The Black/White list:

- Provides a basic solution if a few specific URLs need to be exempted.
- Allows a business to directly manage the URLs to denied as part of company policy.
- Leverages existing network equipment.

### Procedures

**STEP 1** Choose a device on which you want to manage URL Filtering from the **Hostname** list.

**STEP 2** Set filtering options and manage the list of domain names to be filtered:

- a. Check the **Enable** checkbox to enable URL filtering.

When URL filtering is disabled, you can still add and delete URLs to and from the domain name list, but no filtering is performed. URL filtering is disabled by default.

- b. Choose whether to deny all domains except the ones listed or permit all domains except the ones listed.

To add a URL to the list of domain names to be filtered, click **Add**, click in the row you just added, and type the domain name to be filtered. Partial domain names are accepted, as long as they can be validated (for example, cisco.com.is valid).

The maximum number of URLs allowed in the filter list is 100.

- c. Continue adding and removing domain names as needed.

**STEP 3** Click **OK** or **Apply**.

Once you click **OK** or **Apply**, the names in the list cannot be modified. You must delete and then re-add the name in order to change it.

---

You can also import a text file with a list of URLs to be filtered or export the current list of URLs to a text file that can be imported to another device or application. The following guidelines apply to creating URL list files:

- The filename extension for must be either .csv or .txt.
- Lines beginning with "#" are treated as comments.
- Duplicates are not allowed in the list.
- URLs are entered one per line, as shown in the following example:

```
#Domain Name  
www.cisco.com  
www.yahoo.com  
www.rediffmail.com  
www.google.com
```

# Telephony System and Region Settings

This section covers configuration of system and region settings for Telephony. These topics are covered:

- [Voice System Initialization](#)
- [Voice System Settings](#)
- [Region Settings for Telephony](#)

**IMPORTANT** Telnet access must be enabled in order to configure voice features.

## Voice System Initialization

The Voice Initialization window appears when you attempt to open a voice configuration window before initializing system-level voice settings.

If you are not using the Telephony Setup Wizard, you must you must configure these settings before you can configure voice features.

If the UC500 platform you are setting up is in factory default state, we recommend that you use the Telephony Setup Wizard to configure these settings and set up trunking. For more information, see [Telephony Setup Wizard, page 92](#).

Once you have applied these settings, the system is no longer in factory default state, and you cannot use the Telephony Setup Wizard until you reset the UC500 to the factory default configuration.

Click **OK** when you are done, or click **Cancel**.

Field	Description
<b>System Mode</b>	<p>Choose whether to configure call handling for <b>PBX</b> or <b>Keysystem</b>. The default value is PBX.</p> <p>When the <b>System Mode</b> is set to <b>Keysystem</b>, the system is placed in a hybrid mode, where SIP trunks are treated as if the system were in PBX mode, and local trunks (FXO, BRI, PRI) are treated as key system lines. In this mode, FXO trunks and T1/E1 CAS trunks are configured as direct trunk lines.</p> <p>Unlike earlier releases of CCA (1.x), there is no real difference between Keysystem and PBX mode.</p>
<b>Number of Digits Per Extension</b>	Set the extension length. The default value is 3.
<b>Voicemail Access Extension</b>	Internal extension for accessing the voice mail system. The number of digits in the extension must match the specified <b>Number of Digits Per Extension</b> .

## Voice System Settings

To access voice system settings, choose **Configure > Telephony > System > System Settings**.

From the System window, you configure these settings:

- **Hardware Configuration**
- **System Message**
- **System Type Settings**

Click **Apply** or **OK** when you are finished making changes to these settings.

### Hardware Configuration

The UC500 hardware configuration is detected and shown in the Hardware Configuration section. CCA restricts the configuration parameters that can be modified, based on the hardware configuration of the router. Typically, these parameters are fixed.

**System Message**

In the System Message field, enter a message to display on phones, for example, a company name. The message can contain up to 31 characters.

If the System Message field is left blank (does not contain alpha-numeric text) when you apply the configuration, then the message is not updated, and the existing system message displayed on the phones will remain.

**System Type Settings**

System Type settings are available only for the initial configuration:

- These settings can also be configured through the Telephony Setup Wizard or the Voice Initialization window.
- You must reset the UC500 to factory defaults to change these settings.
- After you apply these settings, these fields become read-only.

Setting	Description
<b>Voice System Type</b>	<p>Choose a voice system type, either <b>PBX</b> or <b>Keysystem</b>.</p> <p>When you choose <b>Keysystem</b>, SIP trunks are treated as PBX lines, and local trunks (FXO, BRI, PRI) are treated as key system lines. FXO trunks and T1/E1 CAS trunks are configured as direct trunk lines.</p> <p>There are no other differences between Keysystem mode and PBX mode.</p>
<b>Number of Digits Per Extension</b>	<p>Enter the number of digits for extensions at customer site. The default is 3.</p>

**Region Settings for Telephony**

To configure region and locale settings for Telephony, choose **Configure > Telephony > System > Region** from the feature bar.

From this window, you can chose the:

- Country for call progress tones

- Phone region and language
- Voicemail language
- Format to use for displaying the date and time on phones

The default system locale for the UC500 is US/English. Before configuring non-US locale settings in the Region window, you must download the appropriate UC500 Software Pack and/or Locale Packs (which contain all files for localizing phones and voice mail) and install them on the UC500. See [Installing Software on the UC500, page 503](#) and [How to Localize the UC500 \(Non-US/English Locales\), page 519](#).

You can install up to two languages on the UC500, but only one can be active. If you have two languages installed, you can change which one is the active language from this window. To install additional languages, choose **Maintenance > Software Upgrade > UC500**.

### Configuring Region Settings

From the Region window, you can configure the following locale settings for telephony. When you are finished, click **OK** or **Apply**.

Setting	Description
<b>Devices</b>	
<b>Hostname</b>	Make sure that the UC500 hostname is selected.
<b>Call Progress Tone</b>	
<b>Country</b>	Choose the appropriate country to set tones and cadences for phones.

### Phones

The phone region and language selections displayed here correspond to the phone language and localization files installed on the UC500.

The factory default is US English. If you did not install any other languages, no other options are listed. To install additional languages, choose **Maintenance > Software Upgrade > UC500**. See [Installing Software on the UC500, page 503](#).

<b>Phone Region</b>	Choose the appropriate locale for this installation.
<b>Phone Language</b>	Choose the language that appears on phones.

Setting	Description
<b>Voicemail</b>	
<b>Voicemail Language</b>	<p>Language of the prompts that voice mail users will hear.</p> <p>On a factory default system, only English is available in the Voicemail Language drop-down menu. You must download and install the appropriate UC500 locale packs to localize the voice mail system. To install additional languages, choose <b>Maintenance &gt; Software Upgrade &gt; UC500</b>.</p> <p>See <a href="#">Installing Software on the UC500, page 503</a> for more information about localizing the voice mail system when installing software on the UC500.</p> <p>Up to two languages can be installed, but only one voice mail language can be active at a time.</p>
<b>Date and Time</b>	
<b>Date Format</b>	Date format (dd-mm-yy, mm-dd-yy, yy-mm-dd, yy-dd-mm) for phone display
<b>Time Format</b>	Time format (12-hour or 24-hour) for phone display
<b>Other Settings</b>	
<p>This section displays the currently selected Dial Plan locale and Time Zone, along with information about where these settings are configured in CCA.</p>	





## Voice Ports and Trunks

This section covers configuration of voice ports and trunks. These topics are covered:

- [FXS Ports](#)
- [PSTN Trunks](#)
- [SIP Trunks](#)
- [Trunk Status](#)

### FXS Ports

The FXS Ports window appears when you choose **Configure > Telephony > Ports and Trunks > FXS Ports** on the feature bar.

#### Overview

From the FXS Ports window, you define how built-in FXS ports will be used and choose a signaling type.

Settings for FXS/DID voice interface card (VIC) ports are configured in the Ports and Trunks section of the PSTN Trunks window (see [FXS/DID \(VIC Only\), page 287](#)). If FXS voice interface card ports are configured within the PSTN Trunks setting then the role option can be set to Common Area Phone or Fax.

#### Procedures

Configure FXS Ports as described below, then click **OK** to apply the configuration.

Settings	Explanation
<b>FXS Port</b>	Read-only. Displays the FXS port ID, for example, 0/0/0.

Settings	Explanation
<b>Role</b>	<p>Defines how the device connected to this FXS port will be used and where it is configured. Choose one of the following:</p> <ul style="list-style-type: none"> <li>▪ <b>User phone.</b> Allows advanced features to be configured on the phone such as voice mail. The ports are SCCP controlled and occupy a user license. Available features are further configured from <b>Configure &gt; Telephony &gt; Users and Extensions &gt; User and Phones &gt; User Extensions.</b></li> <li>▪ <b>Common area phone.</b> A common area phone is typically an analog phone located in a lobby or breakroom. Advanced features such as call forwarding and voice mail are not available on these phones. FXS ports assigned to this role are configured on the Analog Extensions tab in the Users and Phones window (<b>Configure &gt; Telephony &gt; Users and Extensions &gt; User and Phones</b>).</li> <li>▪ <b>Fax.</b> Allows integration with features such as SIP Trunk or T.37 Fax to Mail since additional/special configuration is required for them to properly handle fax machines. (<b>Configure &gt; Telephony &gt; Users and Extensions &gt; User and Phones</b>).</li> </ul>
<b>Description</b>	<i>Optional.</i> Enter a description that identifies this FXS port and its usage.
<b>Signal</b>	Choose <b>Loop Start</b> or <b>Ground Start</b> as the signal type, depending on what is required by the service provider. The default is Loop Start.
<b>Extension</b>	<p>If an extension is configured, it is displayed here. To configure an extension, choose <b>Configure &gt; Telephony &gt; Users and Extensions &gt; Users and Phones.</b></p> <p>If this port is assigned a Common Area Phone or Fax role, choose the Analog Extensions tab and enter the extension.</p> <p>If this port is assigned a User Phone role, choose the User Extensions tab, select the phone, and click <b>Edit.</b></p>

## PSTN Trunks

To access PSTN trunk configuration options, choose **Configure > Telephony > Ports and Trunks > PSTN Trunks**. PSTN Trunk settings can also be configured through the Telephony Setup Wizard.

The settings and options displayed on the tabs in the PSTN Trunks window vary, depending on the types of PSTN interfaces available on the UC500 platform that you are configuring.

See the following sections for information on configuring PSTN interfaces.

- **FXO**
- **Basic Rate Interface (BRI)**
- **T1/E1 Interface**
- **FXS/DID (VIC Only)**

### FXO

If there are FXO ports available in the router, this tab displays read-only information indicating the number of FXO ports available. For example:

```
Total Ports: 4 (4 Built-in, 0 VIC)
```

For information about configuring FXO ports, see [Configuring FXO Port Settings, page 288](#).

For information about viewing status and managing FXO ports, see [Trunk Status, page 301](#).

### Basic Rate Interface (BRI)

If a Basic Rate Interface (BRI) is present on the system, configure settings as described in the following table.

**NOTE** If the ISDN PRI is present and selected and if one or more BRI interfaces are also present, you must set the BRI switch type. The Switch Type parameter is used to set the ISDN switch type on the BRI interface to avoid conflicts.

Setting	Description
<b>BRI Switch Type</b>	Choose one of the following the BRI switch types, as directed by your service provider: Basic 5ESS, Basic DMS100, Basic NI, NTT, Basic 1TR6, Basic NET3, VN3, Basic QSIG.
<b>Bearer Capability</b>	Choose one of the following, as directed by your service provider: None, Speech, or 3100 Hz.
<b>ISDN Static TEI</b>	Choose None or select a number to statically configure the Terminal Endpoint Identifier (TEI) value, as directed by your service provider. The TEI value represents any ISDN-capable device attached to an ISDN network that is the terminal endpoint. TEIs are used to distinguish between several different devices using the same ISDN links.

### T1/E1 Interface

If a T1/E1 interface is present, configure settings as described in the following table. Click **OK** or **Apply** when finished.

On UC560 platforms, up to two (2) T1/E1 ports can be configured; these can be ports on a built-in T1/E1 interface or on a T1/E1 interface installed in a VIC slot.

Setting	Description
<b>Connection Type</b>	<p>Click the <b>Connection Type</b> radio button to choose either T1 or E1.</p> <p>This setting is available only for the initial configuration.</p> <p>After this parameter is set, the field becomes read-only. The T1/E1 options appear if the device has a T1/E1 interface.</p>

Setting	Description
<b>Channel Signaling</b>	Choose one of the following: <ul style="list-style-type: none"> <li>▪ ISDN PRI</li> <li>▪ FXO</li> <li>▪ FXS</li> <li>▪ E&amp;M</li> <li>▪ FGD (applies to T1 only)</li> </ul>
<b>ISDN PRI</b>	If you selected ISDN PRI as the channel signaling type, configure the following settings, as directed by your service provider. <ul style="list-style-type: none"> <li>▪ From the <b>Switch Type</b> menu, choose the switch type to be configured. This parameter is used to set the global ISDN switch type and the interface-level switch type.</li> <li>▪ In the <b>Bearer Capability</b> field, choose None, Speech, or 3100 Hz.</li> <li>▪ In the <b>PRI Group</b> section, specify the range of ISDN PRI group time slots.</li> </ul> <p>The default T1 range is 1 time slot to 24 time slots; time slot 24 (the D-channel) is always included. The range of time slot 24 to time slot 24 is invalid.</p> <p>The default E1 range is 1 time slot to 31 time slots; time slot 16 (the D-channel) is always included. The range of time slot 16 to time slot 16 is invalid.</p>

Setting	Description
<b>FGD**</b> <b>** applies to T1 only</b>	<p>If you selected FGD from the Channel Signaling menu, follow these steps:</p> <ul style="list-style-type: none"><li>▪ To choose the signal type, click EANA or OS (operator services).</li><li>▪ To use separate time slots for incoming and outgoing calls, check the <b>Use Separate Groups for Incoming and Outgoing Calls</b> check box.</li><li>▪ In the <b>Time Slots</b> fields, enter the range of time slots.</li></ul> <p>If you checked the <b>Use Separate Groups for Incoming and Outgoing Calls</b> check box, enter the range of incoming time slots in the <b>Incoming Group Time Slots</b> field, and enter the range of outgoing time slots in the <b>Outgoing Group Time Slots</b> field.</p> <p>The default T1 range is 1 time slot to 24 time slots; time slot 24 (the D-channel) is always included. The range of time slot 24 to time slot 24 is invalid.</p>

Setting	Description
<b>FXO</b> <b>FXS</b> <b>E&amp;M</b>	<p>If you selected FXO, FXS, or E&amp;M from the Channel Signaling menu, follow these steps:</p> <ul style="list-style-type: none"> <li>Choose the Signal Type.</li> <li>Check the <b>Use Separate Groups for Incoming and Outgoing Calls</b> check box to use separate time slots for incoming and outgoing calls.</li> <li>In the <b>Time Slots</b> fields, enter the range of time slots.</li> </ul> <p>If you checked the <b>Use Separate Groups for Incoming and Outgoing Calls</b> check box, enter the range of incoming time slots in the <b>Incoming Group Time Slots</b> field, and enter the range of incoming time slots in the <b>Outgoing Group Time Slots</b> field.</p> <p>The default T1 range is 1 time slot to 24 time slots; For these T1 signaling types, there is no dedicated D-Channel.</p> <p>The default E1 range is 1 time slot to 31 time slots; time slot 16 (the D-channel) is always included. The range of time slot 16 to time slot 16 is invalid.</p>

#### FXS/DID (VIC Only)

If a FXS/DID voice interface card (VIC) is present, configure the following settings for each port.

**NOTE:** To configure *built-in* FXS ports, choose **Configure > Telephony > Ports and Trunks > FXS Ports** from the feature bar.

Setting	Description
<b>Mode</b>	Choose FXS or DID
<b>Signal</b>	<p>If the Mode is set to <b>FXS</b>, choose <b>Loop Start</b> or <b>Ground Start</b>, as directed by your service provider.</p> <p>If the Mode is set to <b>DID</b>, choose <b>Immediate</b>, <b>Wink Start</b>, or <b>Delay Start</b>, as directed by your service provider.</p>

Setting	Description
<b>Caller ID</b>	If the Mode is set to FXS, enter the number to be displayed for the Caller ID for this FXS port.  N/A if the Mode is set to DID.
<b>Extension</b>	If the Mode is set to FXS, enter the number to be displayed for the Extension for this FXS port.  N/A if the Mode is set to DID.
<b>Block Restricted Numbers</b>	If the Mode is set to <b>FXS</b> , click <b>Enable</b> or <b>Disable</b> .  N/A if the Mode is set to DID.
<b>Permission</b>	If the Mode is set to FXS, this field is N/A and uneditable until the Caller ID and Extension fields are populated. Once populated, you can choose <b>National</b> , <b>Internal</b> , <b>Local</b> , <b>International</b> , <b>Unrestricted</b> , <b>Local-Plus</b> , or <b>National-Plus</b> .  N/A if the Mode is set to DID.

## Configuring FXO Port Settings

To navigate to the FXO trunk panel from the feature bar, choose **Configure > Telephony > Ports and Trunks > PSTN Trunks > FXO Tab**.

## Editing FXO Port Settings

To modify general port settings or adjust timers and audio settings for the selected port, choose **Edit Settings**. (Double clicking on the selected row will also launch the Edit Settings window.)

The following FXO port setting tabs are:

- **General Tab**
- **Timers Tab**
- **Audio Tab**

### General Tab

To configure the general port settings parameters, complete the fields as described in the following table, then click **OK** or **Apply**.



Contact the service provider of the CO lines to determine how these settings should be configured for a particular site.

Setting	Description
<b>Signaling Type</b>	<p>FXO and FXS interfaces indicate on-hook or off-hook status and the seizure of telephone lines by one of two access signaling methods: loop-start or ground-start.</p> <ul style="list-style-type: none"> <li>▪ <b>Loop Start.</b> Configures the loop start signaling on selected port specifically used for Foreign Exchange Office (FXO) and Foreign Exchange Station (FXS) interfaces. With loop start signaling only one side of a connection can hang up. This is the default setting for FXO and FXS voice ports.</li> <li>▪ <b>Ground Start.</b> Configures the ground start signaling on voice port and specifically used for FXO and FXS interfaces. Ground start signaling allows both sides of a connection to place a call and to hang up.</li> </ul>
<b>Companding Type</b>	<p>Specifies the companding standard used to convert between analog and digital signals in pulse code modulation (PCM) systems.</p> <ul style="list-style-type: none"> <li>▪ <b>u-law.</b> Configures North American u-law ITU-T PCM encoding standard for particular port. This is the default setting.</li> <li>▪ <b>a-law.</b> Configures European a-law ITU-T PCM encoding standard.</li> </ul>

Setting	Description
<b>Supervisory Disconnect</b>	<p>Applies only to Loop Start signaling and typically used for hung voice ports. Supervisory Disconnection options are disabled when Ground Start is selected as the Signaling Type.</p> <p>Supervisory Disconnect options are as follows:</p> <ul style="list-style-type: none"> <li>▪ <b>Anytone</b></li> <li>▪ <b>Dualtone preconnect</b></li> <li>▪ <b>Dualtone mid-call</b></li> <li>▪ <b>Signal</b> This is the default Supervisory Disconnect option for FXO port.</li> </ul> <p>Please contact Small Business Support Center for assistance. For information select <b>Troubleshoot &gt; Support Information</b>.</p>
<b>Enable Battery Reversal</b>	<p>The battery-reversal command applies to FXO and FXS voice ports. FXS ports normally reverse battery upon call connection. The Enable Battery Reversal option restores voice ports to their default battery-reversal operation. If an FXO port or its peer FXS port does not support battery reversal, avoid enabling the battery-reversal command on the FXO port.</p> <p>By default this option is checked.</p>

### Timers Tab

To configure the timers parameters, complete the fields as described in the following table, then click **OK** or **Apply**.

Setting	Description
<b>Packet Jitter Buffer</b>	Playout delay is the amount of time that elapses between the time at which a voice packet is received at the jitter buffer on the digital signal processor (DSP) and the time at which it is played out to the codec.
	Mode: <ul style="list-style-type: none"> <li>▪ <b>Adaptive.</b> When the Playout-delay mode is set to Adaptive, the jitter buffer size and amount of playout delay is adjusted during a call, based on current network conditions. This is the default list option for Playout delay mode.</li> <li>▪ <b>Fixed.</b> When the Playout-delay mode is set to Fixed, the jitter buffer size is not adjusted during a call. Instead, a constant playout delay is added.</li> </ul>
	Nominal:  Configures the initial setup time and minimum allowed delay time that the DSP can insert before playing out voice packets.  The allowable range is 40 - 250 milliseconds.  The default value is 60 milliseconds.
<b>Timer</b>	Configures the Supervisory Disconnect values for the port. This setting is mainly used to ensure that an on-hook indication is intentional.
	Sup-Disconnect Timer:  The allowable range is 50 - 1500 milliseconds.  The default value is 350 milliseconds.

Setting	Description
Timeouts	<p>Wait to Release:</p> <p>Specifies the amount of time a voice port can be held in a call failure state while the Cisco router sends a busy tone, reorder tone, or out-of-service tone to the port. After the timeout expires, the release sequence is enabled.</p> <p>The allowable range is 1 - 3600 seconds.</p> <p>The default setting is 30 seconds.</p>
	<p>Call Disconnect:</p> <p>Specifies the time for which an FXO voice port remains connected after the calling party hangs up, when a call is not answered.</p> <p>The allowable range is 0 - 120 seconds.</p> <p>The default setting is 60 seconds.</p>

### Audio Tab

To configure the audio parameters, complete the fields as described in the following table, then click **OK** or **Apply**.

Setting	Description
<p><b>Echo Tail Coverage</b></p>	<p>Configures echo cancel coverage on voice port and specifically used to adjust the coverage size of the EC. This command enables cancellation of voice that is sent out the interface and received on the same interface within the configured amount of time. If the local loop (the distance from the interface to the connected equipment that is producing the echo) is greater than this amount of time, the configured value of this command should be increased.</p> <p>The allowable range for software pack 8.0 and later is [ 24   32   48   64   80   96   112   128 ] ms</p> <p>The allowable range for all previous software pack releases 24   32   48   64   ms</p> <p>The default value is 128 milliseconds on current 8.0 Software pack and later.</p> <hr/> <p>Enable Echo Cancel:</p> <p>The echo-cancel enable command enables cancellation of voice that is sent out the interface and received back on the same interface; sound that is received back in this manner is perceived by the listener as an echo. Disabling echo cancellation might cause the remote side of a connection to hear an echo. Because echo cancellation is an invasive process that can minimally degrade voice quality, this command should be disabled if it is not needed.</p> <p>The default state is enabled.</p> <p>This is an advanced configuration setting. Please contact Small Business Support Center for assistance. For information select <b>Troubleshoot &gt; Support Information</b>.</p>

Setting	Description
<b>Echo Tail Coverage (continued)</b>	<p>Enable Non-Linear:</p> <p>Configures non-linear command on voice port and specifically used along with echo cancel command. The function enabled by this command is also generally known as residual echo suppression.</p> <p>The default state is enabled only if echo cancel is enabled.</p> <p>This is an advanced configuration setting. Please contact Small Business Support Center for assistance. For information select <b>Troubleshoot &gt; Support Information</b>.</p>
<b>Input Gain</b>	<p>Configures the input gain in decibel on voice port and specifically when user wants to increase the gain of a signal entering the router. If the voice level is too low, user can increase the input gain.</p> <p>The allowable range is -6 dB to +14 dB</p> <p>The default value is 0 dB.</p>
<b>Output Attenuation</b>	<p>Configures the attenuation level in decibel on voice port and specifically when user wants to increase the attenuation of a signal leaving the router. If the voice level is too high, user can increase the attenuation. If the voice level is too low, user can decrease the attenuation.</p> <p>The allowable range is -6 dB to +14 dB</p> <p>The default value is 3 dB.</p>

Setting	Description
<b>Impedance</b>	<p>This setting specifies the terminating impedance of analog telephony interfaces.</p> <p>To adjust the impedance, choose one of the following options.</p> <ul style="list-style-type: none"> <li>▪ <b>600c.</b> 600 ohms + 2.15 uF</li> <li>▪ <b>600r.</b> Resistive 600 ohm termination</li> <li>▪ <b>900c.</b> 900 ohms + 2.15 uF</li> <li>▪ <b>900r.</b> Resistive 900 ohm termination</li> <li>▪ <b>Complex 1.</b> 220 ohms + (820 ohms    115 nF)</li> <li>▪ <b>Complex 2.</b> 270 ohms + (750 ohms    150 nF)</li> <li>▪ <b>Complex 3.</b> 370 ohms + (620 ohms    310 nF)</li> <li>▪ <b>Complex 4.</b> 600r, line = 270 ohms + (750 ohms    150 nF)</li> <li>▪ <b>Complex 5.</b> 320 + (1050 ohms    230 nF), line = 12 Kft</li> <li>▪ <b>Complex 6.</b> 600r, line = 350 ohms + (1000 ohms    210 nF)</li> </ul> <p>The default impedance is country- specific. For North America the default is 600r.</p>

### Copying FXO Port Settings

To copy all port settings from one port to other ports, follow these steps.

- STEP 1** In the FXO tab window click on the row of the table that corresponds to the port you want to copy.
- STEP 2** Click **Copy Settings**. A FXO Port Copy Settings window, listing the port's settings and its corresponding values, will open.
- STEP 3** Under the Copy Settings To section of the window choose the targeted FXO port(s) you wish to paste the copied settings to, then click **Add**.

The Available Ports list is empty if all the ports already have identical settings.

- Click **Select All** to chose all available FXO ports.

- Click **Remove** to remove a selected FXO port(s) from the list.

**STEP 4** Click **OK**.

**STEP 5** In the FXO tab window click **OK** or **Apply** to complete the copy configuration changes.

---

## SIP Trunks

To configure SIP trunk settings, choose **Configure > Telephony > Trunks > SIP Trunks** from the feature bar.

These topics are covered:

- **Overview**
- **SIP Trunks Tab**
- **Generic SIP Trunk Provider Configuration**
- **Advanced Options Tab**

### Overview

SIP trunk parameters configured in this window vary, depending on the selected Service Provider template. SIP trunk parameter values must be obtained from the Internet Telephony Service Provider (ITSP).

If your ITSP is not listed, use the Generic SIP Provider template to configure the SIP trunk. For more information about settings CCA automatically configures using this template, see **Generic SIP Trunk Provider Configuration, page 300**.

From the Advanced Options tab, you can specify IP addresses that are permitted to access your VoIP network.

To learn more about SIP trunking on Cisco SBCS/UC500 platforms, visit the following link in the Cisco Small Business Support Community:

<https://supportforums.cisco.com/docs/DOC-9830/>

### SIP Trunks Tab



To configure SIP trunk parameters, complete the fields as described in the following table, then click **OK** or **Apply**.

Field	Description
<b>Service Provider</b>	<p>SIP trunk service provider that this router will connect to for PSTN access.</p> <p>Cisco-certified SIP Service Providers are identified in the drop-down Service Provider list with Cisco logo.</p> <p>To configure SIP trunk parameters for other providers, choose <b>Generic SIP Trunk Provider</b> from the Service Provider drop-down list and complete the fields required by that Service Provider. For more information about Generic SIP Trunk Provider configuration, see <a href="#">Generic SIP Trunk Provider Configuration, page 300</a>.</p> <p>The <b>Add</b> and <b>Delete</b> options in the Service Provider drop-down list are provided so that custom templates for Service Providers can be imported or deleted.</p> <ul style="list-style-type: none"> <li>▪ The built-in templates for Cisco-certified Service Providers cannot be deleted.</li> <li>▪ Templates to be imported are obtained from the SIP Service Provider.</li> </ul> <p>When a new Service Provider template is added, it becomes available for selection in the Service Provider list and the appropriate Service Provider-specific configuration settings are displayed when it is selected. For custom templates, version and timestamp information is displayed.</p>
<b>Proxy Server (primary)</b>	IP address or DNS hostname of the primary SIP proxy server for the ITSP.
<b>Proxy Server (secondary)</b>	<i>Optional.</i> IP address or DNS hostname of the secondary (backup) SIP proxy server for the ITSP.
<b>Registrar Server</b>	<i>Optional.</i> IP address or DNS hostname of the SIP registrar server for the ITSP. This field is required if the ITSP requires SIP registrations.

Field	Description
<b>Outbound Proxy Server</b>	<i>Optional.</i> IP address or DNS hostname of the Session Border Controller (SBC) for the ITSP. This setting is required if the IP address of the SBCS at the ITSP is not the same as the SIP proxy server.
<b>Maximum Number of Calls</b>	<p><i>Optional.</i> Number of concurrent calls allowed for call admission control. You must configure this setting if the ITSP requires the UC500 to limit the number of concurrent calls. Check with your ITSP to see whether this setting is required.</p> <p>The range for the supported number of concurrent calls is listed in brackets, for example, [1-48]. The maximum number of concurrent calls is equal to the number of licenses on the UC500.</p> <p>When you change this setting, the Maximum Calls setting configured under <b>Configure &gt; Telephony &gt; Maximum Calls</b> is also updated. See <a href="#">Maximum Calls (Call Admission Control), page 468</a>.</p>
<b>Company Name</b>	<p><i>Optional.</i> Name of the customer's business to be used for Caller ID. This field is required if a specific Caller ID must be provided for outbound calls. In most cases, this is handled by the ITSP. Check with the ITSP to see whether setting is required.</p> <p>This value is inserted into the header of the SIP invite.</p>
<b>Digest Authentication</b>	<p><i>Optional.</i> <b>Username</b> and <b>Password</b> for SIP registration or calling. This setting is required if a SIP Registrar server is present.</p> <p>Click the <b>Display Password as Plain Text</b> checkbox to toggle display of the password in plain text.</p>

Field	Description
<b>Domain Name Service</b>	<p><i>Optional. SIP Domain Name.</i> Domain name for the SIP server. the SIP Domain Name is specific to Voice over IP (VoIP) services.</p> <p><i>Optional. DNS Server Address.</i> IP address of the DNS server for the SIP domain. You can configure a DNS server here if no DNS server is configured and domain names are being used for SIP trunk configuration. However, the preferred location for DNS configuration is on the Device Configuration tab in the IP Addresses window (<b>Configure &gt; Routing &gt; IP Addresses</b>).</p>
<b>User Credentials</b>	<p><i>Optional.</i> This field is required if the ITSP requires SIP registration with a unique username and password per DID for all DIDs associated to the UC500. Most ITSPs only register the main number.</p> <p>To add a set of user credentials for ITSPs that require per-DID SIP authentication:</p> <ol style="list-style-type: none"> <li>1. Click <b>Add</b> to create a new row in the table.</li> <li>2. Click in the <b>Username</b> column for the new row and enter a username. In general, the username field will contain an E.164-format PSTN number.</li> <li>3. Click in the <b>Password</b> column for the new row and enter the password provided by the ITSP.</li> <li>4. Click the <b>Enter Password as Plain Text</b> checkbox to toggle display of user passwords in plain text.</li> <li>5. Repeat these steps to add more credentials.</li> </ol>

To delete a set of per-DID SIP user credentials, follow these steps.

- 
- STEP 1** Click in the row in the table that corresponds to the set of credentials you want to delete.
- STEP 2** Click **Delete**.
- STEP 3** Click **Apply**.
-

### Generic SIP Trunk Provider Configuration

When **Generic SIP Trunk Provider** is selected for the SIP provider template, CCA displays all of the configurable options for SIP trunks.

In addition to the configuration options shown, CCA automatically configures these settings on SIP trunks configured using the generic template:

- **Voice codec:** G.711-ulaw
- **Fax codec:** G.711
- **DTMF (dual-tone multi-frequency) payload:** 101
- **SIP registration:** Registers main number only

The Generic SIP Trunk template is not compatible with all ITSPs. To request a CCA template for a new SIP provider, go to the following link on the Cisco Small Business Support Community:

<https://supportforums.cisco.com/docs/DOC-9685/>

### Advanced Options Tab

For security reasons, CCA blocks SIP traffic from unknown sources. Configure additional IP addresses here if your provider uses SIP gateways with IP addresses that are different from the proxy servers configured on the SIP Trunks tab.

Consult your SIP provider for the addresses of the SIP gateways that they use.

To configure additional IP addresses that are permitted access to the VoIP network, follow these steps.

- 
- STEP 1** Click **Add** to open a new row in the table for editing.
  - STEP 2** Enter the IP address.
  - STEP 3** Configure additional IP addresses, if needed.
  - STEP 4** Click **OK**.
-

---

## Trunk Status

The Trunk Status window appears when you choose **Configure > Telephony > Ports and Trunks > Voice Trunk Settings** on the feature bar.

### Overview

From the Trunk Status window, you can view Trunk Port, Current Status, and Action.

From the Action drop-down window inactive voice ports can be shut down. This ensures calls are not sent to the selected port(s) if no devices are attached.

When a voice port is shut down, no calls can be directed to it. However, the port is still shown as an available option on other screens in Configuration Assistant. The configuration can still be applied to the port, but the port must be manually re-activated before it can begin using that configuration.

### Procedures

To shut down or reset a voice trunk port, select the port from the list and choose **Reset Port** or **Shutdown Port** from the drop-down menu in the Action column. Then click **Apply** or **OK**.

To re-activate a voice trunk that was shut down, select the port from the list and choose **Activate Port** from the drop-down menu in the Action column. Then click **Apply** or **OK**.



# Users and Extensions

This section explains how to configure settings for users, phones, and extensions that are listed under the **Configure > Telephony > Users and Extensions** on the feature bar.

These topics are covered:

- **Users and Phones**
- **Voicemail and Notifications**
- **Single Number Reach (SNR)**
- **System Speed Dials**

## Users and Phones

To open the Users and Phones window, choose **Configure > Telephony > Users and Extensions > Users and Phones** from the feature bar.

See the following sections for more information on configuring the options on each of the tabs in the Users and Phones window:

- **User Extensions**
- **Floating Extensions**
- **Extension Mobility**
- **Analog Extensions**
- **Configuring Phone Button Assignments**

## User Extensions

Follow the instructions in this section for:

- [Adding, Editing, and Deleting Phones](#)
- [Importing Phone Data for Multiple Users \(Bulk User Import\)](#)

**TIP** Left-click and drag with the mouse on column headers on the User Extensions tab to rearrange the columns in the view. You can also left-click on the column header in the view to sort the data in ascending or descending order.

### Adding, Editing, and Deleting Phones

When you plug an IP phone into the UC500 it registers automatically, and is assigned an IP address on the voice VLAN (VLAN100) using DHCP. The MAC address of the phone is also discovered and displayed.

You can also add unregistered phones and configure their settings. Later, when the phone is plugged in, it will receive the configuration.

Users and extensions for phones connected to FXS ports that are assigned a User Phone role are also configured here.

For step-by-step instructions, see these sections:

- [Adding a Phone](#)
- [Editing a Phone](#)
- [Deleting a Phone](#)

If you are adding and pre-configuring a large number of phones, you perform a bulk import of user and phone data. For instructions on performing a bulk import, see [Importing Phone Data for Multiple Users \(Bulk User Import\), page 310](#).

### Adding a Phone

You can add a phone and pre-configure its settings before it is physically connected to the system.

To add a phone and associate a user with the phone, follow these steps.

- 
- STEP 1** In the Users and Phones window, click the **Add** button at the bottom of the window.



**STEP 2** Configure these settings for the new phone.

Field	Description
<b>Phone Information</b>	
<b>MAC Address</b>	Enter the MAC address for this IP phone.
<b>Phone Type</b>	<p>Choose the IP phone model from the drop-down list.</p> <p>When you select a Phone Type, the Button Assignment tab updates to display the correct number of rows for the model you select.</p>
<b>Expansion Module</b>	<p><i>Optional.</i> For phones that support expansion modules, the <b>Expansion Module</b> menu lists supported models.</p> <p>CCA does not automatically discover expansion modules that are connected to phones. If one or more expansion modules are connected to a phone, you must manually select them here. The “x2” selections in the list indicate that two expansion modules are connected to the phone.</p> <p>When you choose an expansion module from the list, rows are added to the button list for the line buttons on the expansion module and phone model graphic updates to display the expansion module.</p>

Field	Description
<b>Allow Video Calls</b>	<p>Choose whether to allow video calls for this phone.</p> <p>The <b>Allow video calls</b> setting does not apply to Analog Phones or ATAs.</p> <ul style="list-style-type: none"><li>▪ When <b>Allow video calls</b> is checked, Cisco Unified Voice Advantage (CUVA) is enabled for this user's phone. When coupled with a USB video camera, CUVA enables a PC connected to a Cisco Unified IP Phone or to Cisco IP Communicator to add video to internal calls made on the phone.</li><li>▪ When <b>Allow video calls</b> is unchecked, video calls are not allowed for this phone.</li></ul> <p>If this setting has been modified from its original value, that value is retained if you change the Phone Type. In most cases, you would only change the Phone Type when adding an unregistered phone. If this is the case, you must manually edit this setting after changing the Phone Type.</p> <p>By default, <b>Allow video calls</b> is initially un-checked.</p> <p><b>NOTE</b> The following phones do not support video calls:</p> <ul style="list-style-type: none"><li>▪ SPA300 Series IP Phones</li><li>▪ SPA500 Series IP Phones</li><li>▪ Unified IP Phone 6901</li><li>▪ Unified IP Phone 6911</li></ul>

Field	Description
<b>Use as Teleworker Phone</b>	<p>Check or uncheck the <b>Use as teleworker phone</b> option to enable or disable MTP.</p> <p>When <b>Use as teleworker phone</b> is checked, Media Termination Point (MTP) is configured on the phone so that Cisco Unified CME terminates the media stream. The MTP setting causes the UC500 to act as a proxy. Media packets are forwarded to other IP phones with the IP address of the UC500 in the source address field. MTP is typically used in remote teleworker phone deployments.</p> <p>When this option is unchecked, MTP is not configured on the phone.</p> <p>The <b>Use as teleworker phone</b> checkbox is not displayed for Cisco IP Communicator (CIPC) softphones, since MTP is always configured for CIPC softphones.</p>
<b>User Information</b>	
<b>Last Name</b>	Phone user first name. The first name is displayed in the directory and used for Auto Attendant Dial-by-Name service.
<b>First Name</b>	Phone user last name. The last name is displayed in the directory and used for Auto Attendant Dial-by-Name service.
<b>User ID</b>	User ID for this phone user. This ID is used when logging in to Cisco Unity Express User Options web pages to change phone settings.
<b>Password</b>	<p>Password for this IP phone.</p> <p>Password is mandatory if voicemail is enabled and optional if voicemail is disabled.</p> <p>This password is used by the phone user to log in to Cisco Unity Express User Options web pages to change phone settings. The password applies only to the Cisco Unity Express GUI, and the IMAP (Internet Message Access Protocol). If this is an SCCP phone, this field also applies to the CME (Cisco Unified Communications Manager Express) GUI.</p>

Field	Description
<b>Extension Mobility</b>	
<b>Enable Extension Mobility</b>	<p>When this box is checked, Extension Mobility is enabled for this phone. Checkbox is in the enabled state only when there is a minimum of one phone profile configured and available. For more information, see <a href="#">Extension Mobility, page 317</a>.</p> <p><b>CAUTION</b> If this is an existing user, their voice mailbox, button assignments, speed dials and phone configuration will be removed and overwritten by the selected phone profile when you click OK.</p>
<b>Select Logout Profile</b>	<p>Choose a phone logout profile to apply to this user's phone. For more information, see <a href="#">Extension Mobility, page 317</a>.</p> <p>The phone profile defines the default button assignment of the phone when there is no Extension Mobility user login.</p>
<b>Phone Button Assignments and Speed Dials</b>	
<b>Button Assignments</b>	<p>For each button you want to configure on the phone, select a <b>Button Type</b>.</p> <p>You must choose a <b>Phone Type</b> before you can configure Button Assignments.</p> <p>The <b>Button &lt;#&gt;</b> area of the page displays the settings that must be configured for the selected Button Type.</p> <p>For detailed information about the types of buttons that can be assigned to each type of button and their associated settings, see <a href="#">Configuring Phone Button Assignments, page 328</a>.</p>
<b>Speed Dials</b>	<p>Click the <b>Speed Dials</b> tab to configure speed dials for the phone. For more information, see <a href="#">Speed Dials, page 312</a>.</p>

**STEP 3** Click OK.

### Editing a Phone

After you have added a phone, follow the steps in this section to edit phone settings.

When a phone is physically connected to the UC500 it is discovered and listed by its MAC address. It does not automatically receive an extension or any default user information. You must edit the phone and configure these settings.

**IMPORTANT** In releases of CCA prior to 3.0, phones were automatically assigned an extension and some placeholder user information, but this is no longer the case. You must edit phone settings to add the required configuration after the phones are connected.

When the User Extensions tab is initially selected, it displays a list of all user phones. Analog ports that are configured with a role of User Phone are listed on the User Extensions page as Analog Phones. The MAC address, phone model, first extension, user first and last name, and the user ID are displayed for each phone.

To edit phone settings, follow these steps.

- 
- STEP 1** Click on a phone to select it, then click the **Edit** button at the bottom of the window to display its details. You can also double-click on a phone in the list to open its details for editing.
  - STEP 2** Edit settings as needed. For information about phone settings configured here, see [Adding a Phone, page 304](#).
  - STEP 3** Click **OK** to send the configuration to the device.
- 

### Deleting a Phone

To delete one or more phones, follow these steps.

- 
- STEP 1** Unplug the phones to be deleted.
  - STEP 2** Choose **Configure > Telephony > Users and Extensions > Users and Phones** from the feature bar.
  - STEP 3** In the Users and Extensions window, click on the phones that you want to delete to select them.
  - STEP 4** Click **Delete**. All selected phones are deleted.
-

## Importing Phone Data for Multiple Users (Bulk User Import)

A sample Microsoft Excel file named `BulkUserImport.xls` is provided for entering phone data for multiple users. This data can be exported to XML and imported into CCA.

If you installed Configuration Assistant to the default location, this file is located in the following directory:

**C:\Program Files\Cisco Systems\CiscoSMB\Cisco Configuration Assistant\appdata**

To import data for multiple phones and users into CCA, follow these steps.

- 
- STEP 1** On your PC, locate the Excel file named `BulkUserImport.xls` in the `appdata` directory under the CCA installation directory on your PC.
  - STEP 2** Click **Enable Macros** when prompted. For the import to work correctly, macros must be enabled.
  - STEP 3** Make a copy of the file and give it a different name.
  - STEP 4** Open the file and enter the information required in the `.xls` file. All data entered must be within the table provided in the spreadsheet.

Field Name	Description
<b>User ID</b>	<i>Required.</i> User ID to associate with this phone.
<b>First Name Last Name</b>	<i>Required.</i> First name and last name of the user associated with this phone. The first and last names can be displayed on the phone, used for Auto-Attendant dial-by-extension, and are included in directory listings.
<b>Phone Type</b>	<i>Required.</i> From the drop-down list, choose the model for this phone.  Choose the /14 option if an expansion module will be connected to the phone. Choose the /14x2 selection if two expansion modules will be connected.
<b>MAC Address</b>	<i>Required.</i> Enter the MAC address of the phone in the following format: <code>nnnn.nnnn.nnnn</code> (for example, <code>ABCD.1234.1234</code> ).

Field Name	Description
<b>Extension</b>	<i>Required.</i> Enter an extension number to use for the first extension on the phone (button 1).  The number of digits must match the extension length chosen for the site (variable-length extensions are not supported).
<b>Password</b>	<i>Required.</i> User password for this phone.
<b>Line Type</b>	<i>Required.</i> Choose either Dual or Octal from the drop-down list.
<b>CFNA Extn</b>	<i>Required.</i> Internal extension or external phone number to use as the destination for unanswered calls to the first (primary) extension.  When specifying an external number, enter the number exactly as it would be dialed on your system, including access codes.
<b>CFB Extn</b>	<i>Required.</i> Internal extension or external phone number to use as the destination for calls when the first (primary) extension is busy.  When specifying an external number, enter the number exactly as it would be dialed on your system, including access codes.
<b>CFNA Timeout</b>	<i>Required.</i> Number of seconds before unanswered calls are transferred to the CFNA destination. The default is 20 seconds.

- STEP 5** Click the **Generate XML** button in the .xls file to export and save the data to an XML file.
- You can name the XML file anything you want, but it must have a .xml extension.
- STEP 6** Launch CCA and navigate to **Configure > Telephony > Users and Extensions > Users and Phones**.
- STEP 7** In the Users and Phones window, click the **Import** button at the bottom of the window.
- STEP 8** Click **Browse** and navigate to the location of the XML file on your PC that contains the generated phone and user data.

- STEP 9** Click **OK** to upload the file. CCA validates the XML data when you import the file.
- STEP 10** If there are errors, you must fix them in the .xls file, re-generate the XML, then re-import the generated .xml file into CCA.
- STEP 11** When you are finished, click **OK**.

## Speed Dials

For information about configuring personal speed dials on user's phones or EM profiles, see these sections:

- [Overview](#)
- [Procedures](#)

### Overview

You can configure personal speed dials for individual phones, Extension Mobility phones (via the EM Phone Profile), and Extension Mobility users (via the EM User Profile). These speed dials are accessed by pressing buttons on the phone or from menus on the IP phone.

For example, the phone user Ted Brown has 205 as his primary extension, an intercom on button 2, and three speed dials configured on his phone. Buttons 3 through 5 display the speed dials.



The following usage guidelines apply to speed dials configured from this window:

- Up to 55 speed dials can be configured.
- These speed dials are applied in order, beginning with the first available button on the user's phone.



- Speed dial buttons cannot be placed between line or feature buttons. For example, if button 1 is configured as a Normal extension and button 3 is configured as an Intercom button, the first speed dial is assigned to button 4. A speed dial cannot be assigned to button 2. This also applies to button assignments for phones with expansion modules.
- If the number of speed dials configured is greater than the number of buttons on the user's IP phone, the phone user can access the rest of the speed dials from menus on their IP phone. To access these speed dials:
  - Press the **services** button on their IP phone.
  - From the CME Service URLs menu, choose **My Phone Apps**.
  - From the My Phone Apps menu, choose **Speed Dial Buttons**.
- An IP phone user can also use abbreviated dialing feature with these speed dials. To use abbreviated dialing:
  - With the phone on-hook, press the number of the speed dial as it appears in the menu list. For example, to dial the tenth speed dial in the list, the user presses "1" then "0."
  - Press the **AbbrDial** softkey to dial the number.
- Speed dials that the user manually adds from the **services** menu on their phone are also displayed on the Speed Dials window in CCA.
- IP phones are restarted automatically after speed dial configuration is applied.

### Procedures

To add, edit, or delete speed dials, for individual phones or EM profiles, follow these steps.

- 
- STEP 1** Choose **Configure > Telephony > Users and Extensions > Users and Phones** from the feature bar.
- STEP 2** To configure speed dials for a regular phone user, select the User Extensions tab in the Users and Phones window.
- To configure speed dials for an Extension Mobility user or phone profile, select the Extension Mobility tab, select the User Profile or Phone Profile sub-tab, then click the Speed Dials tab.
- STEP 3** Click in a row of the table to select a phone for which you want to configure speed dials.

You can sort phones in the list by extension, phone type, first name, last name, user ID, or MAC address.

**STEP 4** Click **Edit**. The Edit Phone window appears.

**STEP 5** In the Edit Phone window, select the Speed Dials tab.

**STEP 6** On the Speed Dials tab, follow these steps to add a speed dial.

- a. Click on the row that corresponds to the speed dial button number that you want to add or edit.
- b. In the **Number** field, enter a phone number exactly as the user would dial it, including an access code for external dialing or site dialing prefix, if needed.

East Asian double-byte characters are *not* supported with speed dials.

The **Number** field accepts these characters: digits 0-9, A, B, C, D, #, \* and +. The non-digit characters can be used for security access or other systems that a customer may have at their site.

- c. In the **Label** field, enter a label to identify the speed dial button on the phone display.

**STEP 7** Continue adding speed dial buttons as needed.

**STEP 8** Click **OK** when you are finished.

**STEP 9** The affected phones are restarted automatically. IP phones that are in use are restarted after the current call completes.

**STEP 10** To delete a speed dial, follow these steps.

- a. Click on the row that corresponds to the speed dial button number you want to delete.
- b. In the **Number** field, manually delete the phone number.
- c. In the **Label** field, manually delete the data.

**STEP 11** Click **OK** when you are finished.

The affected phones are restarted automatically. IP phones that are in use are restarted after the current call completes.

## Floating Extensions

To access configuration settings for Floating Extensions, choose **Configure** > **Telephony** > **Users and Extensions** > **Users and Phones** and select the Floating Extensions tab.

### Overview

A floating extension is an extension that is not associated with any phone. Here are some examples of how this feature can be used.

- You can use floating extensions to create voice mailboxes that are not associated to a phone. Users can access their voice mail from any phone on the system by simply dialing the voice mail extension or voice mail PSTN access number. They are prompted to enter their voice mail PIN. The default PIN for voice mail access is 1234. Users accessing voice mail for the first time will be prompted to change their PIN.
- You can configure a floating extension for a mobile worker and configure it to forward all calls to a cell phone number.

The forwarded number can be changed without having to change the extension number, and the actual number (in this case a cell phone number) is not exposed to the caller.

You can map a DID number to a floating extension on the Direct Dialing tab in the Incoming Dial Plan window (**Configure** > **Telephony** > **Dial Plan** > **Incoming**).

A floating extension can be assigned as:

- A night service extension.
- A **No Answer Forward to** destination for calls to a hunt group. In the **No Answer Forward to** drop-down list, choose **Other Number** and enter the floating extension number.
- A destination for calls transferred from the Auto Attendant. Select **Call Other Number** and enter the floating extension number.

### Procedures

To add or edit a floating extension, follow these steps.

- 
- STEP 1** Choose **Configure** > **Telephony** > **Users and Extensions** > **Users and Phones**.
  - STEP 2** Select the Floating Extensions tab.

- STEP 3** Click **Add** or select an existing floating extension from the list and click **Edit**. The Add/Edit Floating Extensions window appears.
- STEP 4** Configure settings as described in [Adding or Editing Floating Extensions](#).
- STEP 5** Click **OK**.

### Adding or Editing Floating Extensions

To create an extension that is not associated with any phone, configure settings as described below, then click **OK**.

Setting	Description
<b>Extension Settings</b>	
<b>Number</b>	Extension number to use for the floating extension. The extension must be unique and must contain the correct number of digits for your system.
<b>PSTN Number</b>	If a DID number has been mapped to this extension, it is displayed here. If not, the text “No DID mapped” appears.  To associate a DID number to an extension, go to <b>Configure &gt; Telephony &gt; Dial Plan &gt; Incoming</b> and select the Direct Dialing tab. In the Direct Dial to Internal Extensions section of the page, click <b>Add</b> or <b>Modify</b> to create or edit the mapping between the desired DID number and the floating extension or range of floating extensions.
<b>Call Forward All</b>	Forward all calls to this extension to the specified number. If the number is an external number, include any access codes that are required.
<b>Enable Voicemail</b>	Create a voice mailbox for this extension. When this setting is checked, User Information is required.

Setting	Description
<b>User Information</b>	
User information is only required if Auto Attendant Dial-by-Name service is required or you wish to enable voice mail for the floating extension.	
<b>First Name</b>	First name of the user associated with this floating extension. It is displayed in the directory and used for Auto Attendant Dial-by-Name service.
<b>Last Name</b>	Last name of the user associated with this floating extension. It is displayed in the directory and used for Auto Attendant Dial-by-Name service.
<b>User ID</b>	User ID for the user associated with this floating extension. This user ID is used to log in to Cisco Unity Express User Options web pages to change voicemail settings.
<b>Password</b>	<p>Password for the user associated with this floating extension.</p> <p>This password is used to log in to Cisco Unity Express User Options web pages to change voicemail settings. The password applies only to the Cisco Unity Express GUI, and the IMAP (Internet Message Access Protocol). If this is an SCCP phone, this field also applies to the CME (Cisco Unified Communications Manager Express) GUI.</p>
<b>Clear User Fields</b>	Remove all user information from this floating extension.

## Extension Mobility

The Extension Mobility (EM) feature allows you to provide phone mobility for end users.

A user login service allows Cisco IP phone users to log in to an EM-enabled phone where they can make and receive calls using their personal directory number and speed dials and optionally access a personal voice mailbox.

For information about the Extension Mobility feature and the settings that are configured on each tab, see these sections:

- [Example Extension Mobility Deployment Scenarios](#)
- [EM User Profile](#)
- [EM Phone Profile](#)

### Overview

To set up Extension Mobility for a site, you must perform these steps:

- **Configure general settings.** These are global settings that apply to all EM-enabled phones. You can configure up to 3 auto-logout times. At the specified time, all EM sessions on EM-enabled phones are automatically logged out. You can also specify whether the EM user's call history is cleared at logout. See [General Settings, page 322](#).
- **Create EM User Profiles.** The EM User Profile defines the button assignments and speed dial settings that the EM user will see when they log in to an EM-enabled phone. Every EM user must have a profile. See [EM User Profile, page 320](#).

**Create EM Phone Profiles.** The EM Phone Profile defines the button assignments and speed dial settings of an EM-enabled phone when there are no EM users logged in to the phone. Multiple phones can be associated with the same Phone Profile. See [EM Phone Profile, page 321](#).

\* The CCA Phone Profile is also referred to as a Logout Profile in Cisco IOS.

- **Enable selected IP phones for the EM service.** A phone is enabled for Extension Mobility when it is associated with a Phone Profile. [Enabling EM on a Phone, page 321](#).

### Example Extension Mobility Deployment Scenarios

This section describes some common deployment scenarios for extension mobility and an overview of the configuration steps for each.

#### Scenario 1: Mobile employees share EM-enabled phones

In this scenario, a pool of IP phones are enabled for EM service. Mobile employees (for example, salespersons) share these EM-enabled phones when they are onsite, instead of having personal desk phones. Each mobile employee has a personal mailbox and their own phone button assignments and speed dials when they log into an EM-enabled phone.

In this type of deployment, you will need to:

1. Create an EM Phone Profile that specifies the default button assignments and speed dials that the phone will have when no one is logged into it. Typically this is a very simple profile with restricted calling permissions. See [EM Phone Profile, page 321](#).
2. Enable EM service for each of the IP phones in the common pool by associating it with a Phone Profile. See [Enabling EM on a Phone, page 321](#).
3. Create an EM User Profile for each mobile employee. This profile will have the employee's personal extensions and speed dials. In each EM User Profile, enable and assign a personal mailbox to the user's primary extension. See [EM User Profile, page 320](#).

### **Scenario 2: Mobile employees share common phones when onsite, but have their own IP phones at another location**

In this scenario, a pool of common phones at a site are enabled for EM service. Mobile employees share these phones when they are onsite, but also have a primary IP phone at another location. When they log into an EM-enabled phone, their personal Normal and Share extensions and speed dials are the same as on their primary IP phone. They can access their personal mailbox from an EM-enabled phone, in addition to their primary phone.

In this type of deployment, you will need to:

1. Create an EM Phone Profile that specifies the default button assignments and speed dials that the phone will have when no one is logged into it. Typically this is a very simple profile with restricted calling permissions. [EM Phone Profile, page 321](#).
2. Enable EM service for each of the IP phones in the common pool by associating it with the EM Phone Profile you created. [Enabling EM on a Phone, page 321](#).
3. Create an EM User Profile for each mobile employee with the desired button assignments and speed dials. See [EM User Profile, page 320](#).

For the EM user to use the same phone number at an EM enabled phone and their home IP phone, a Share line should be used for the primary number. To access the same voice mail box the share line should be enabled with a Personal Share mailbox.

In order for the EM user to use the same phone number and voice mailbox at an EM enabled phone and also at his/her home IP phone, a Share line should be provisioned as the primary number with the voicemail option enabled.

## Requirements and Limitations

The following limitations apply to configuring Extension Mobility using CCA:

- Cisco Unified CallManager Express (CME) version 8.0 or later is required.
- CCA currently supports only the Normal and Share line types on the User and Phone profiles.
- The maximum number of EM users allowed is equal to the three (3) times the number of phone licenses for the UC500 platform that the customer has (3 work shifts).
- If you want an EM user to also have a phone, assign the same number to the EM Profile and the user's phone using a share line. Set up the mailbox for the share line as a Personal (Share) mailbox.
- Existing phone users cannot be automatically converted to Extension Mobility Users, and Extension Mobility Users cannot automatically be converted to regular phone users. You must manually delete the user from the Users and Extensions tab and re-create the user by creating a user profile on the Extension Mobility tab. The user's existing voice mailbox will be deleted.
- No softkeys are provided for direct access to Extension Mobility on EM phones. EM users must go to the CME Services Menu on their phone and select the Extension Mobility menu item to log in and log out.
- A user profile can only be active on one phone at a time. When an EM user who is already logged on to one phone logs in to a different phone using the same profile, they are automatically logged out of the first phone.
- After-hours call blocking is not supported.

## EM User Profile

The EM User Profile defines the phone buttons and speed dials the user will see when they are logged in to an EM-enabled phone.

If a personal mailbox is required for the user, you must enable the mailbox. A user ID, password, First Name, and Last Name are required when creating an EM User Profile.

To create or edit an EM User Profile, follow these steps.



- 
- STEP 1** On the Extension Mobility tab in the Users and Phones window, select the User Profiles tab.
  - STEP 2** To create a new EM User Profile, click **Add**.
  - STEP 3** To edit an existing EM User Profile, locate the user in the profile list, click anywhere in the row to select that user's profile, and click **Edit**.
  - STEP 4** Configure settings as described in [Add Extension Mobility User Profile, page 323](#).
  - STEP 5** Click **OK**.
- 

### EM Phone Profile

The EM Phone Profile defines the button assignments and speed dial settings of an EM-enabled phone when there are no EM users logged in to the phone. Multiple phones can be associated with the same Phone profile.

To create or edit an EM Phone Profile, follow these steps.

- 
- STEP 1** On the Extension Mobility tab in the Users and Phones window, select the Phone Profiles tab.
  - STEP 2** To create a new EM Phone Profile, click **Add**.
  - STEP 3** To edit an existing EM Phone Profile, locate the phone in the profile list, click anywhere in the row to select that phone's profile, and click **Edit**.
  - STEP 4** Configure settings as described in [Add Extension Mobility Phone Profile, page 325](#).
  - STEP 5** Click **OK**.
- 

### Enabling EM on a Phone

To enable Extension Mobility on a phone, follow these steps.

- 
- STEP 1** On the User Extensions tab in the Users and Phones window, click on a phone in the list and click **Edit** or click **Add** to add new phone.
  - STEP 2** In the Extension Mobility section of the Add or Edit Phone Settings window, check the **Enable Extension Mobility** option.

When you enable extension mobility on a phone:

- If this is a new phone, all of the user information and line assignment tabs are disabled.
- If a user is currently associated with the phone, all of their user information, phone button assignments, and speed dials are cleared and will be deleted when the change is applied.
- If the user currently associated with the phone has a personal voice mailbox, the mailbox is also deleted when the configuration is applied.

**STEP 3** In the **Select Phone Profile** drop-down list, select the EM Phone Profile to associate with this phone.

When you select a Phone Profile, the User Information area of the window updates to display the user information that is currently configured for that phone profile.

**STEP 4** Click **OK**.

---

### General Settings

Configure global logout settings for all EM-enabled phones at your site as described below, then click **OK**.

Setting	Description
<b>Auto-logout</b>	<p>Configure up to 3 auto-logout times, using a 24-hour format. These auto-logout settings apply to all EM-enabled phones.</p> <p>At the specified auto-logout time, all sessions on all EM-enabled phones are logged out.</p> <p>If a call is in progress at the auto-logout time, the user's session is logged out after the call ends.</p>
<b>Clear call history after user logout</b>	<p>When this option is checked, the call history for the logged-in EM user is removed when the user logs out or auto-logout occurs.</p>

## Add Extension Mobility User Profile

This window appears when you click **Add** or **Edit** from the User Profiles tab under Extension Mobility in the Users and Phones window. You can also double-click on an existing EM User Profile to open this window.

The EM User Profile defines the button assignments and speed dial settings that the EM user will see when they are logged in to an EM-enabled phone. Every EM user must have a profile. You can also choose to enable a personal mailbox for the EM user.

Configure a user profile as described below, then click **OK**.

Setting	Description
<b>Profile Settings</b>	
<b>User ID</b> <b>Password</b>	<p><i>Required.</i> Enter the User ID and password for logging into EM-enabled phones.</p> <p>Since the user will be entering the ID and password on the phone keypad to log in, it should be brief.</p> <p>The same User ID and Password also define the login credential for accessing the CUE GUI.</p>
<b>First Name</b> <b>Last Name</b>	<p><i>Required.</i> The EM profile user first name and last name are also included in the directory and used for Auto Attendant dial-by-name service.</p>
<b>Auto Logout Timeout (minutes)</b>	<p>Enter the number of minutes of idle time you want to elapse before the profile user is automatically logged out.</p>

Setting	Description
<b>Enable Privacy Button</b>	<p>When the <b>Enable Privacy Button</b> option is checked, a Privacy button is placed on the phone. The Privacy button is used in conjunction with the Conference Barge (cBarge feature).</p> <p>The Privacy button is placed on the phone automatically by IOS according to the following rules:</p> <ul style="list-style-type: none"><li>▪ The Privacy button is assigned after the last line or feature button appearance and cannot be placed between line or feature buttons.</li></ul> <p>For example, if buttons 1 and 2 are in use, then the Privacy button is assigned to button 3. If buttons 1, 2, and 5 are in use, then the Privacy button is assigned to button 6, even though button 3 and 4 are unused.</p> <ul style="list-style-type: none"><li>▪ If there are not enough buttons on the physical phone, the Privacy button will not appear on the phone.</li></ul>

Setting	Description
<b>Details</b>	
<b>Line</b>	<p>Select the <b>Line</b> tab to assign buttons to this EM User Profile.</p> <ul style="list-style-type: none"> <li>To add or delete extension lines, specify the number of desired extensions into the <b>Number of Extension Lines</b>. You can add up to 69 extensions.</li> </ul> <p>For each button:</p> <ul style="list-style-type: none"> <li>Choose a <b>Button Type</b>, either <b>Normal</b> or <b>Share</b>. See <a href="#">Normal Extension, page 328</a> and <a href="#">Share Extension, page 333</a> for information about configuring options for these button types.</li> <li>Specify the extension number or select a share extension.</li> <li>Enter a descriptive label for the button. This label appears on the phone.</li> <li><i>Optional.</i> Check the <b>Mailbox</b> option to create a mailbox for this extension.</li> </ul>
<b>Speed Dials</b>	<p>Select the Speed Dials tab to assign speed dials to this EM User Profile.</p> <p>For more information, see <a href="#">Speed Dials, page 312</a>.</p>

### Add Extension Mobility Phone Profile

This window appears when you click **Add** or **Edit** from the Phone Profiles tab under Extension Mobility in the Users and Phones window.

The EM Phone Profile defines the phone buttons and speed dials the user will see when there are no EM users using the phone.

Configure a phone profile as described below, then click **OK**.

Setting	Description
<b>Profile Settings</b>	
<b>User ID</b> <b>Password</b>	<p><i>Optional.</i> The User ID and Password are only required if a voice mailbox is enabled for this phone profile.</p> <p>The same User ID and Password also define the login credential for accessing the CUE GUI.</p>
<b>First Name</b> <b>Last Name</b>	<p><i>Optional.</i> Phone user first name and last name are only required if a voice mailbox is enabled for this phone profile.</p> <p>If defined, the EM profile user first name and last name are also included in the directory and used for Auto Attendant dial-by-name service.</p>
<b>Enable Privacy Button</b>	<p>The Privacy button is used in conjunction with the Conference Barge (cBarge feature).</p> <p>The Privacy button is placed on the phone automatically by IOS according to the following rules:</p> <ul style="list-style-type: none"> <li>The Privacy button is assigned after the last line or feature button appearance and cannot be placed between line or feature buttons.</li> </ul> <p>For example, if buttons 1 and 2 are in use, then the Privacy button is assigned to button 3. If buttons 1, 2, and 5 are in use, then the Privacy button is assigned to button 6, even through button 3 and 4 are unused.</p> <ul style="list-style-type: none"> <li>If there are not enough buttons on the physical phone, the Privacy button will not appear on the phone.</li> </ul> <p>The Privacy button in the Phone Profile can also be toggled at the <b>Telephony &gt; Voice Features &gt; Conference Barge</b> window after it is assigned to a phone.</p>

Setting	Description
<b>Details</b>	
<b>Line</b>	<p>Select the Line tab to set the number of extension lines and assign buttons to this EM phone profile.</p> <ul style="list-style-type: none"> <li>To add or delete extension lines, specify the number of desired extensions into the <b>Number of Extension Lines</b> field, then click <b>OK</b>. You can add up to 69 extension lines.</li> <li>For each button, choose a button type, enter or select an extension to assign, and enter a descriptive label for the button.</li> </ul> <p>You can only add <b>Normal</b> and <b>Share</b> phone buttons. See <a href="#">Normal Extension, page 328</a> and <a href="#">Share Extension, page 333</a> for information about configuring the button section for these button types.</p>
<b>Speed Dials</b>	<p>Select the Speed Dials tab to assign speed dials to this Phone Profile.</p> <p>For more information, see <a href="#">Speed Dials, page 312</a>.</p>

## Analog Extensions

The ports listed on the Analog Extensions tab are FXS ports that have been configured with the **Common area phone or Fax** role from the **Configure > Telephony > Ports and Trunks > FXS Ports** window. These devices include legacy analog phones and FAX machines.

These notes apply when configuring analog extensions:

- In the **Extension** field, enter a unique extension.
- Advanced features such as voice mail, call forwarding, and so on, are not available on phones configured as analog extensions.
- To prevent the user from calling the restricted (blocked) numbers configured in the outgoing dial plan, check the **Block Restricted Numbers** check box.
- The **Permissions** settings specify the type of outgoing calls that can be placed from this phone. For more information, see [Permissions, page 331](#).

After making changes in this window, click **Save Settings** apply the configuration.

## Configuring Phone Button Assignments

For information on the types of buttons that can be configured on the phone and detailed information about Button <#> settings (where <#> stands for button number), see the following sections:

- [Normal Extension, page 328](#)
- [Share Extension, page 333](#)
- [Setting Up GDM or Personal \(Share\) Mailbox for Shared Extensions, page 334](#)
- [Monitor, page 335](#)
- [Watch, page 336](#)
- [CO Line, page 336](#)
- [Overlay Extension, page 337](#)
- [Intercom, page 338](#)
- [Dialable Intercom, page 339](#)
- [Whisper Intercom, page 341](#)
- [Octal Lines, page 344](#)

### Normal Extension

When you configure a phone button as a Normal extension, a single extension is assigned to the button.

To configure **Button <#>** section for a Normal extension button, follow these steps.

- 
- STEP 1** Choose **Configure > Telephony > Users and Extensions > Users and Phones** and select the User Extensions tab.
  - STEP 2** Click on a phone in the list to select it, then click the **Edit** button to displays its configuration details.
  - STEP 3** Select the **Button Assignments** tab.
  - STEP 4** Choose a button number.



**STEP 5** In the **Button <#>** section, configure settings for the extension as described below.

Field	Description
<b>Button Type</b>	Using the pull-down menu, set to <b>Normal</b> .
<b>Parameters Tab</b>	
<b>Extension</b>	Enter the desired extension number for this line.
<b>Button Label</b>	Enter the desired label for this button.
<b>Description</b>	<p>Specify a description for this phone. This description is displayed in the top right corner on the phone.</p> <p>Valid characters in this field are alpha-numeric characters (A-Z, a-z, 0-9, spaces, period (.), underscore (_), and minus (-) sign.</p> <p>For example, your customer may require the full Direct Inward Dial (DID) phone number to be displayed on phones. You can edit this description field so that it displays the DID number, for example, 555 555-5555.</p>
<b>Dual Line or Octal Line</b>	<p>Line type, either dual or octal. This selection applies only to Normal button and Share button types. The default value is Octal Line, if the phone supports this feature.</p> <p>An octal line directory number supports up to eight active calls, both incoming and outgoing, on a single phone button. The Octal is not available for phones that do not support this feature. Octal lines are only available if the UC500 is running Cisco IOS version 12.4(20)T or later, and the Cisco UC500 software pack version is 7.0(2) or later. For more information, see <a href="#">Octal Lines, page 344</a>.</p> <p>A shared octal-line extension is required for enabling the Conference Barge (cBarge) feature. See <a href="#">Conference Barge, page 385</a>.</p>

Field	Description
<b>Enable Voicemail</b>	<p>Click to enable (checked) or disable (unchecked).</p> <p>When the Mailbox option for a Normal line is checked, a personal mailbox is created for this extension. Only one personal mailbox can be created per user.</p> <p>The mailbox and its contents are not deleted when you re-associate the mailbox to a different extension.</p>
<b>Block Restricted Numbers</b>	<p>To prevent the user from calling the restricted (blocked) numbers configured in the outgoing dial plan, check the <b>Block Restricted Numbers</b> check box.</p>

Field	Description
<b>Permissions</b>	<p>This setting specifies the type of outgoing calls that can be placed from this phone. Permission levels are defined in the outgoing dial plan (<b>Configure &gt; Telephony &gt; Dialplan &gt; Outgoing Dial Plan</b>, and select the Outgoing Call Handling tab). Choose one of the following:</p> <ul style="list-style-type: none"> <li>▪ <b>Unrestricted.</b> Can place outgoing calls to the PSTN without any restrictions.</li> <li>▪ <b>Internal.</b> Can place outgoing calls only by dialing internal and emergency numbers. Restricted from placing all other calls.</li> <li>▪ <b>Local.</b> Can place outgoing calls only by dialing local, internal, and emergency numbers. Restricted from placing local plus, domestic long distance, or international calls.</li> <li>▪ <b>Local plus.</b> Can place outgoing calls by dialing local, internal, and emergency numbers plus additional local numbers as defined in the outgoing dial plan.</li> <li>▪ <b>National.</b> Can place outgoing calls only by dialing national long distance, local, internal, and emergency numbers. Restricted from placing national plus numbers and international calls.</li> <li>▪ <b>National plus.</b> Can place outgoing calls only by dialing national long distance, local, internal, and emergency numbers, plus additional numbers as defined in the outgoing dial plan. Restricted from placing international calls.</li> <li>▪ <b>International.</b> Can place outgoing calls by dialing internal, local, national long distance, emergency, and international numbers.</li> </ul>
<b>Call Forward Busy</b>	<p>Transfer calls to this extension when this line is busy. Click in the field and enter an extension to change the setting.</p> <p>If the Voicemail check box is checked when Call Forward Busy is empty then Call Forward Busy is defaulted to Voicemail's extension number.</p>

Field	Description
<b>Call Forward No Answer</b>	<p>Transfer incoming calls to this extension if there is no answer. Click in the field and enter an extension to change the setting.</p> <p>If the Voicemail check box is checked when Call Forward No Answer is empty then Call Forward No Answer is defaulted to the Voicemail's extension number.</p>
<b>CFNA Timeout, seconds</b>	<p>Number of seconds before unanswered calls are transferred to the Call Forward No Answer destination. The default is 20 seconds.</p> <p><b>IMPORTANT</b> If this extension is a member of a Call Blast Group, the <b>CFNA Timeout</b> value you set here must be greater than the Timeout value configured for the Call Blast Group. For example, if the Timeout value for the Call Blast Group that the extension belongs to is 10 seconds, set the CFNA timeout for the extension to at least 11 seconds. Alternatively, you can lower the Timeout value for the Call Blast Group. See <a href="#">Call Blast Groups, page 368</a>.</p>
<b>PSTN Number</b>	<p>Read-only field that displays the PSTN number that is mapped to this extension in the incoming dial plan, if configured.</p> <p>To map DID numbers to internal extensions, choose <b>Configure &gt; Telephony &gt; Dial Plan &gt; Incoming</b>, select the <b>Direct Dialing</b> tab, and configure settings under <b>Direct Dial to Internal Extensions</b>.</p>

### Call Hold Alert Tab

The Call Hold Alert feature enables you to set up an audible, repeating alert tone to notify the user when a call is placed on hold on a Cisco IP phone.

<b>Call Hold Alert</b>	<p>Choose one of following settings to specify when Call Hold alert tones are played.</p> <ul style="list-style-type: none"> <li>▪ <b>None.</b> Alerts are disabled. This is the default setting.</li> <li>▪ <b>When Idle.</b> Alerts are played only when the phone is idle.</li> <li>▪ <b>When Idle or Busy.</b> Alerts are played when the phone is busy or idle.</li> <li>▪ <b>When Idle or Alert Shared.</b> Alerts are played only when the extension is idle. Alerts are played on all phones that share this extension.</li> </ul>
------------------------	--

Field	Description
<b>Timeout</b>	<p>Number of seconds between audible alert notifications. Enter a value from 15 to 300.</p> <p>For example, if this value is set to 25 seconds, the call hold alert tone is played once every 25 seconds.</p>

**STEP 6** Click **OK**.

### Share Extension

You can set up a shared extension and add a button for the shared extension to multiple phones so that incoming calls to that extension ring all the phones with a button for the share extension.

For information about creating voice mailboxes for shared extensions, see [Setting Up GDM or Personal \(Share\) Mailbox for Shared Extensions, page 334](#).

To set up a shared extension, follow these steps.

- STEP 1** Set up phones and users, as described in [Adding a Phone, page 304](#).
- STEP 2** Choose **Configure > Telephony > Users and Extensions > Users and Phones**, to open the Users and Phones window, then select the User Extensions tab.
- STEP 3** Click on a phone to select it, then click the **Edit** button at the bottom of the window to display its details.
- STEP 4** Click the **Button Assignments** tab.
- STEP 5** Choose a button number in the table and set its type to **Share**.
- STEP 6** In the **Extension** field for that phone button, enter or choose the extension to use for the share line.
- To create a new shared extension, enter unique extension number to use for the shared extension.
  - To put an existing shared extension on the selected phone button, choose an extension from the drop-down list.
  - If you selected Button 1 on the phone for the shared extension, only shared extensions on Button 1 of other phones are listed in the drop-down list.

- If you selected a button other than Button 1, only shared extensions that are not on Button 1 appear in the drop-down list.

**STEP 7** If this is a new shared extension, configure the **Button <#>** section for the share line, as described in the section **Normal Extension, page 328**.

Voice mail boxes are treated a little differently for shared extensions. For more information, see **Setting Up GDM or Personal (Share) Mailbox for Shared Extensions, page 334**.

**STEP 8** In the **Share Name** field, enter the name to use for this shared extension. A name is required if the shared extension is on a non-primary button.

**NOTE** The **Share Name** field is disabled if the shared extension is placed on Button 1 of the phone. For shared extensions placed on Button 1, user information is pre-populated from the user for which the shared extension was initially created (except for the User ID and password, which must be unique per phone).

**STEP 9** Click **OK** when you are finished.

**STEP 10** Place calls to the share extension to verify that the extensions are shared on phones as expected.

---

### Setting Up GDM or Personal (Share) Mailbox for Shared Extensions

When you enable voice mail for a shared extension, the type of mailbox that is created by default is different between shared extensions that are placed on Button 1 of a phone than for the other buttons on the phone:

- If **Enable Voicemail** is checked for a shared extension on Button 1 of a phone, a Personal (Share) mailbox is created by default. This functionality is provided for cases in which a single user has multiple phones but wants a single personal mailbox that they can access from all of their phones. If, for some reason, the user with multiple phones does not want to use Button 1 for this, it is possible to create the shared extension on a different button, then go to the Mailboxes tab on the Voicemail window, change the GDM mailbox to a Personal (Share) mailbox, and select the desired User ID from the drop-down list. Only users with this shared extension that do not currently have an enabled Personal voice mailbox will be listed. After you change the mailbox type to Personal and choose a user, CCA removes the GDM mailbox and creates a Personal (Share) mailbox for the shared extension using the specified user ID.

Alternatively, you could first define a Normal extension for the user and assign a Personal mailbox to it, then redefine the same extension as a shared

extension using the same extension number and enable the voice mailbox. CCA will retain the Personal mailbox and re-associate it with the shared extension.

- If **Enable Voicemail** is checked for a shared extension on any other button, a GDM (group mailbox) is created by default. When assigning a GDM to a shared extension on a phone, the user should also have a personal mailbox assigned in order to access the GDM using their own Personal voice mail PIN.

When you add the shared extension to other phones, be sure to enable the mailbox for the extension if you want the user to be able to access the GDM mailbox.

## Monitor

A Monitor button monitors only the specified extension.

The line status indicates whether the line is either idle or in use. A receptionist can use Monitor buttons to visually monitor the in-use status of phone extensions.

To configure a Monitor button, follow these steps.

- 
- STEP 1** Choose **Configure > Telephony > Users and Extensions > Users and Phones** and select the User Extensions tab.
  - STEP 2** Click on a phone in the list to select it, then click the **Edit** button to display its configuration details.
  - STEP 3** Select the **Button Assignments** tab.
  - STEP 4** Choose a button number and set its **Type** to **Monitor**.
  - STEP 5** In the **Button <#>** area for this button, select the extension to be monitored from the drop-down list. Call Park extensions are included in the list of extensions that can be monitored.

The label of the monitored extension is automatically inserted in the Label field for the Monitor button.

- STEP 6** Click **OK**.
-

## Watch

A Watch button allows a user to watch all lines on the phone with the specified extension.

The line status indicator on the Watch button lights Red when any line on the watched phone is in use, out-of-service, or in Do Not Disturb mode.

The phone user can press the Watch button to speed-dial the watched extension. Other calls cannot be made or received using a line button that is in watch mode. Incoming calls on a line button that is in watch mode do not ring and do not display caller ID or call-waiting caller ID.

To configure a watch button, follow these steps.

- 
- STEP 1** Choose **Configure > Telephony > Users and Extensions > Users and Phones** and select the User Extensions tab.
  - STEP 2** Click on a phone in the list to select it, then click the **Edit** button to displays its configuration details.
  - STEP 3** Select the **Button Assignments** tab.
  - STEP 4** Choose a button number and set its **Type** to **Watch**.
  - STEP 5** In the **Button <#>** area for this button, select the extension to be watched from the drop-down list.  
  
The label of the watched extension is automatically inserted in the Label field for the Watch button.
  - STEP 6** Click **OK**.
- 

## CO Line

Choose CO Line if you want to assign a Central Office line (direct trunk line) to this button. You cannot assign a mailbox to a CO Line button.

To configure a CO Line button, follow these steps.

- 
- STEP 1** Choose **Configure > Telephony > Users and Extension > Users and Phones** and select the User Extensions tab.
  - STEP 2** Click on a phone in the list to select it, then click the **Edit** button to displays its configuration details.



- 
- STEP 3** Select the **Button Assignments** tab.
  - STEP 4** Choose a button number.
  - STEP 5** In the **Type** drop-down menu for the selected button, choose **CO Line**, for example, **CO 1 (0/1/0)**.

These correspond to direct PSTN trunk lines connected to FXO ports. Edit the **Label** as needed to identify the CO line.

- STEP 6** In the **Button <#>** area for this button, select the trunk line to use for the CO Line from the drop-down list.
- STEP 7** Click **OK**.

---

### Overlay Extension

A normal Overlay extension enables multiple lines (up to 25) to share a single button on a multi-button phone. Overlay extensions require at least two available normal, share, or CO line extensions.

CCA also supports Overlay configuration on a CO (Central Office) line. This configuration allows a CO Line to share a button with a regular extension. The user can answer calls on that CO Line and see the state of the line, but can still make and receive calls using their regular extension. This functionality is most useful phones with a limited number of buttons.

**NOTE** Octal lines do not support Overlay. This means that extensions that are configured for features such as Conferencing or Conference Barge (cBarge) cannot be overlaid.

To configure an Overlay button, follow these steps.

- 
- STEP 1** Choose **Configure > Telephony > Users and Extensions > Users and Phones** and select the User Extensions tab.
  - STEP 2** Click on a phone in the list to select it, then click the **Edit** button to displays its configuration details.
  - STEP 3** Select the **Button Assignments** tab.
  - STEP 4** Choose a button number and set its **Type** to **Overlay**.
  - STEP 5** In the **Button <#>** area for this button, select the extension to use for the Overlay from the drop-down list.

**STEP 6** In the **Button <#>** area, configure these settings.

- a. Choose whether to enable or disable call waiting for this overlay extension. When the **Enable Call Waiting** option is checked, call waiting is enabled on the overlay extension.

With call waiting enabled, if the Overlay extension is in use and a second call comes in on the Overlay extension, the call waiting tone is played and the call is displayed on the IP phone screen.

- b. Use the **Add**, **Remove**, **Select All** and **Select None** buttons to move share extensions from the Available Extensions list to the Selected Extensions list.

You must choose at least two (2) extensions for the Overlay button. Normal, Share, and CO line extensions appear in the Available Extensions list.

- c. Use the **Up** and **Down** arrows to re-order the extensions in the Selected Extensions list.
- d. *Optional.* In the **Overlay Button Label** field, enter a descriptive name for this extension to display on the phone.

By default, the label for the first extension number on the Selected list is used for the overlay button label. When you edit the Overlay Button Label, the label for the first extension number is also changed.

**STEP 7** Click **OK**.

---

## Intercom

An Intercom button is a push-to-talk, single-button intercom line between two IP phones.

- Multiple intercoms can be configured on one phone.
- Button 1 cannot be configured as an intercom.

To configure an Intercom button, follow these steps.

---

**STEP 1** Choose **Configure > Telephony > Users and Extensions > Users and Phones** and select the User Extensions tab.

**STEP 2** Click on a phone in the list to select it, then click the **Edit** button to displays its configuration details.

- STEP 3** Select the **Button Assignments** tab.
- STEP 4** Choose a button number and set its **Type** to **Intercom**.
- STEP 5** In the **Button <#>** area for this button, configure these settings.
- From the **Target Intercom Button User** drop-down list, choose a target user. The intercom button is placed on this user's phone.
  - From the **Target Intercom Button Number** drop-down list, choose an available button on the target user's phone to use for the intercom.
  - In the **Label for the Target User** field, enter the text you want to display on the target user's phone desktop next to this Intercom button.  
  
When the Intercom button is pressed on this user's phone, this label text is displayed in the From: field of the calling information displayed on the target user's phone.
  - In the **Label for the Current User** field, enter the text you want to display on this user's phone desktop for this Intercom button.  
  
When the Intercom button is pressed, this text is displayed in the To: field of the calling information on this user's phone.
- STEP 6** Choose whether to enable or disable Mute for this Intercom.
- When the **With Mute** option is enabled (checked), the recipient of the intercom must deactivate mute by pressing the Mute button on their phone or lift the handset to respond to the intercom.
- When the **With Mute** option is disabled (unchecked), both parties hear each other when the call is connected.
- STEP 7** Click **OK**.

---

## Dialable Intercom

For information about Dialable Intercoms, see these sections:

- [Feature Description, page 339](#)
- [Unsupported Phones, page 340](#)
- [Configuration Steps, page 340](#)

### Feature Description

Intercom button that allows a phone user to intercom any other phone on the system that also has a dialable intercom button by pressing the intercom button and dialing the extension they want to intercom.

Unlike normal Intercoms and Whisper Intercoms, which are always configured between two specific phones, phone users can intercom other phones by pressing the Intercom button on their phone and dialing a Dialable Intercom extension.

Dialable intercoms are used by operators or administrative staff who provide support for many employees, as opposed to administrative assistants who are generally responsible for one or two people and have specific intercom buttons on their phone for each person. When this feature is used, a Dialable Intercom button is usually configured on every user's phone.

Only one dialable intercom button can be configured per phone.

CCA does not allow Dialable Intercoms to be configured on button 1 of a phone.

You can optionally configure the Dialable Intercom with or without Mute.

- When **Mute** is enabled for the intercom, the called phone automatically answers the call in speakerphone mode with Mute activated. The phone beeps when the Intercom call is auto-answered to alert the recipient to the incoming intercom call.

To respond to the intercom call and enable two-way audio, the recipient deactivates the Mute function by pressing the Mute button on their phone or, on some phones, lifting the handset.

- When **Mute** is disabled, both the caller and the recipient immediately hear each other when the Intercom call is connected.

The benefit of disabling Mute is that the recipient of the intercom call can speak and be heard without having to first deactivate the Mute function. However, nearby background sounds or conversations can be heard as soon as the intercom call is connected.

### Unsupported Phones

Dialable Intercoms are not supported on these phones:

- Analog phones
- ATAs

### Configuration Steps

To configure Dialable Intercom button, follow these steps:

- 
- STEP 1** Choose **Configure > Telephony > Users and Extensions > Users and Phones** and select the User Extensions tab.
- STEP 2** Click on a phone in the list to select it, then click the **Edit** button to displays its configuration details.
- STEP 3** Select the **Button Assignments** tab.
- STEP 4** In the button list, click on the number of the button you want to use for the Dialable Intercom.
- Only one dialable intercom button can be configured per phone.
- STEP 5** In the **Type** drop-down menu, choose **Dialable Intercom**.
- STEP 6** In the **Dialable Intercom** options area to the right, configure these settings.
- Choose an extension from the **Dialing Digits** drop-down menu. This is the extension that users on the system dial to intercom this phone. All normal extensions configured on the phone are listed.
  - Choose whether to enable or disable **Mute** for intercom calls.
- When **Mute** is enabled, the called phone automatically answers the call in speakerphone mode with Mute activated, and the recipient must deactivate the Mute button in order to speak. When **Mute** is disabled, both of the parties on the Intercom call immediately hear each other.
- STEP 7** *Optional.* In the **Label** column of the button list, edit the label for the Dialable Intercom button that is displayed on the phone. The default label is Dialable Intercom<Ext>.
- STEP 8** Click **OK**.
- 

## Whisper Intercom

The Whisper Intercom allows an intercom call to a busy extension. The calling party can only be heard by the recipient. For more information, see these sections:

- [Feature Description, page 342](#)
- [Requirements and Limitations, page 342](#)
- [Unsupported Phones, page 342](#)

- [Procedures, page 343](#)

### Feature Description

To place a Whisper Intercom call, the phone user presses the Whisper Intercom button on their phone.

- The phone receiving a Whisper Intercom call displays the extension and name of the party that initiated the intercom, and a zip-zip tone plays before the called party hears the caller's voice. The Whisper Intercom button lights Amber to indicate one-way audio.
- If the recipient of the Whisper Intercom wants to speak to the phone user who initiated the Whisper Intercom, they press the Whisper Intercom button on their phone, which will then light Green to indicate two-way audio.
- When the recipient of the Whisper Intercom presses the Whisper Intercom button to talk, the active call on their phone is automatically put on hold.

To end a Whisper Intercom call, the phone user presses the **EndCall** softkey.

### Requirements and Limitations

The following requirements and limitations apply to Whisper Intercoms configured using CCA:

- Whisper Intercom requires Cisco Unified CME 7.1 or later and SCCP 12.0 or later on IP phones.
- Whisper Intercom requires CIPC 7.x or later on CIPC (Cisco IP Communicator) phones.
- A Whisper Intercom button can place calls only to another Whisper Intercom.
- Only one intercom call at a time (either incoming or outgoing) is allowed on a phone.

### Unsupported Phones

Whisper Intercoms are only available on phones that support octal lines. Whisper Intercoms are not currently supported for these phones:

- Analog FXS phones
- ATAs
- Cisco Model 7931 IP phones with firmware versions prior to 8.5(3)
- Cisco Model 39xx IP phones

- Cisco Model CP-521 IP phones
- Cisco SPA500 Series and SPA300 Series IP phones
- Cisco Model 7902, 7905, 7906, 7910, 7911, and 7912 IP phones
- Cisco Model 7940 and 7960 IP phones

### Procedures

To configure a Whisper Intercom button, follow these steps.

- 
- STEP 1** Choose **Configure > Telephony > Users and Extensions > Users and Phones** and select the User Extensions tab.
- STEP 2** Click on a phone in the list to select it, then click the **Edit** button to displays its configuration details.
- STEP 3** Select the **Button Assignments** tab.
- STEP 4** Choose a button number and set its **Type** to **Whisper Intercom**.
- STEP 5** In the **Button <#>** area for this button, configure these settings.
- a. From the **Target Intercom Button User** drop-down list, choose a target user. The Whisper Intercom button is placed on this user's phone.
  - b. From the **Whisper Intercom Button Number** drop-down list, choose an available button on the target user's phone to use for the Whisper Intercom.
  - c. In the **Label for the Target User** field, enter the text you want to display on the target user's phone desktop next to this Whisper Intercom button.  
  
When the Whisper Intercom button is pressed on this user's phone, this label text is displayed in the From: field of the calling information displayed on the target user's phone.
  - d. In the **Label for the Current User** field, enter the text you want to display on this user's phone desktop for this Whisper Intercom button.  
  
When the Whisper Intercom button is pressed, this text is displayed in the To: field of the calling information on this user's phone.
- STEP 6** Click **OK**.
-

## Octal Lines

An Octal Line directory number supports up to eight active calls, both incoming and outgoing, on a single phone button:

- Unlike a dual-line directory number, which is shared exclusively among phones (after a call is answered, that phone owns both channels of the dual-line directory number), an octal line directory number can split its channels among other phones that share the directory number.
- All phones are allowed to initiate or receive calls on the idle channels of the shared octal line directory number. One octal line directory number can handle multiple calls. Multiple incoming calls to an octal line directory number ring simultaneously.
- After a phone answers a call, the ringing stops on that phone and the call-waiting tone plays for the other incoming calls.
- When phones share an octal line directory number, incoming calls ring on phones without active calls and these phones can answer any of the ringing calls. Phones with an active call hear the call-waiting tone.
- After a connected call on an octal line directory number is put on hold, any phone that shares this directory number can pick up the held call. If a phone user is in the process of initiating a call transfer or creating a conference, the call is locked and other phones that share the octal line directory number cannot take the call.
- Missed calls (calls not answered) are not displayed by default.
- A shared octal-line extension is required for enabling the Conference Barge (cBarge) feature. For more information, see [Conference Barge, page 385](#).

The following limitations apply to octal lines:

- Octal lines do not support Overlay. This means that extensions that are configured for features such as Conferencing or Conference Barge (cBarge) cannot be overlaid.
- Octal lines are only available if the Cisco IOS version on the UC500 is 12.4(20)T or later, and the Cisco Unified Communications Manager Express (CUCME) version is 7.0 or later. Upgrading to the latest UC500 Software Pack is recommended.
- Not all Cisco IP phone models support octal lines.
- Cisco IP Phone Models 7920, 7902, 7931G, CP-52xG, CP-52xSG, and Cisco SPA500 Series IP phones do not support octal lines.



- Cisco ATA and analog FXS ports do not support octal lines.

## Voicemail and Notifications

The topics in this section provide instructions for configuring voicemail and notifications:

To configure Voicemail settings and mailbox options, choose **Configure > Telephony > Users and Extensions > Voicemail** from the feature bar. See the following topics for information on how to enable and configure voice mail features.

- [Overview](#)
- [General Guidelines](#)
- [Setup](#)
- [Mailboxes](#)
- [Notifications](#)

### Overview

From the Voicemail window, you configure basic voice mail settings for the site, view and edit the amount of voicemail storage in minutes for each mailbox.

### General Guidelines

The following guidelines apply to voice mailboxes and notifications:

- When adding users and phones through the Telephony Setup Wizard, voice mailboxes are created if the option to enable voice mail for the user is checked.
- Users can access their voice mail from any phone on the system by simply dialing the voice mail extension or voice mail PSTN access number. They are prompted to enter their voice mail PIN in order to access the mailbox. The default PIN for voice mail access is 1234. Users accessing voice mail for the first time are prompted to change their PIN.
- When adding users through the expert mode UI or .xml file upload, Personal mailboxes are initially created on the system for users when **Call Forward Busy** or **Call Forward No Answer** settings for any Normal extension are

configured to go to voice mail. These settings are configured on the User Extensions tab in the Edit Phone window (**Configure > Telephony > Users and Extensions > Users and Phones > Edit Phone**).

- The default setting for both **Call Forward Busy** and **Call Forward No Answer** is Voicemail. This means that if you add a user and do not modify both of these settings when the user is added, a voice mailbox is automatically created for that user. You can disable the voice mailbox later from the User Extensions tab in the Edit Phone window (**Configure > Telephony > Users and Extensions > Users and Phones > Edit Phone**).
- When you change an existing user's **Call Forward Busy** and **Call Forward No Answer** setting from Voicemail to a different option, the user's mailbox remains on the system. If you no longer want that user to have a voice mailbox, you must disable it manually from the User Extensions tab in the Edit Phone window (**Configure > Telephony > Users and Extensions > Users and Phones > Edit Phone**).
- One personal mailbox can be created per user and it can be associated with any one of the Normal extensions configured for the user or a Personal (Share) extension.
- General Delivery Mailboxes (GDMs) are created for shared extensions, hunt groups, and call blast groups when **No Answer Forward To** is set to Voicemail for the group or share extension. You can also choose to create a Personal (Share) mailbox for shared extension.

**TIP:** The Dashboard view (**Home > Dashboard**) provides a **Voicemail Status** item that displays a summary of system and per-mailbox voice mail storage usage, per-mailbox information, and status.

### Setup

On the Setup tab, you configure these basic voice mail settings for a site:

- Voicemail access extension and PSTN number
- Prefix for direct transfer to voice mail
- Global site settings to enable notification of incoming voice mail messages via email and/or phone
- Enable VoiceView Express and LiveReply features for the site

To configure system voice mail settings, complete the fields on the Setup tab as described below, then click **OK**.

Setting	Description
<b>Access Numbers</b>	
<b>Voicemail Access Extension</b>	Internal extension number for voicemail access. The default Voicemail Access Extension is 399.
<b>Voicemail Access PSTN Number</b>	<i>Optional.</i> External PSTN number for voicemail access. This must be a full E.164 number. This is the number that external callers dial to reach voice mail.  The Voicemail Access PSTN Number can begin with a “+” character.
<b>Voicemail Features</b>	
<b>VoiceView Express</b>	<b>VoiceView Express</b> allows phone users to interact with their Cisco Unity Express voice mailbox using their Cisco IP Phone display and softkeys on the phone.  Users can manage personal mailbox options, manage notifications, send, listen to, record, and manage voicemail messages. The feature provides an alternative to the Telephony User Interface (TUI) and web interface for these tasks. By default, this feature is enabled.

Setting	Description
<b>Live Reply</b>	<p><b>Live Reply</b> enables Cisco Unity Express voice mail users who listen to voice mail messages by phone or Voice View Express to reply to another user's message by pressing 4-4.</p> <p>When Live Reply is invoked, Cisco Unity Express attempts to establish a call between the two parties. If the attempt is successful, the voice mail user is connected to the called party or the voice call is forwarded based on rules defined by the called party.</p> <p>After the call is ended, the initial connection to voice mail is disconnected. The voice mail user is not returned to their voicemail session. To review other voice mail messages after a successful live-reply session, the user must re-dial the voice mail access number. By default, this feature is disabled.</p>

Setting	Description
<b>Play Caller ID for Incoming Messages</b>	<p>Enables or disables playing of spoken Caller ID for incoming voicemail messages.</p> <p>When <b>Play Caller ID for Incoming Messages</b> is enabled and an incoming voicemail message is received, depending on whether the incoming call is from an internal or external number:</p> <ul style="list-style-type: none"><li>▪ <b>Internal calls.</b> If the caller ID information matches an entry in the local directory, the system plays the spoken caller name from the local directory when the recipient listens to that message.</li><li>▪ <b>External calls.</b> If the caller ID information does not match an entry in the local directory, the system plays the sender's telephone number when the recipient listens to that message.</li></ul> <p>For external calls, the system does not verify that the caller ID information is valid. That function depends on the Central Office (CO) and the incoming trunk setup.</p> <p>An external call is one that is from any telephone number that is not listed in the local user directory. Possible sources of external calls are the local telephone company, an IP telephone, or an H.323 gateway. These sources must be configured to present caller ID information to the voice mail system.</p>

Setting	Description
<b>Direct Transfer</b>	
<b>Enable Direct Transfer to Voicemail</b>	<p data-bbox="711 413 1484 485">Check this option to enable <b>Direct Transfer to Voicemail</b> and specify a <b>Voicemail Transfer Prefix</b>.</p> <p data-bbox="711 512 1500 730">The <b>Voicemail Transfer Prefix</b> can be a number from 1 through 9. The default value is 6. The prefix is used by the Auto Attendant and by phone users who do not have softkeys for transferring calls to voice mail on their phone. The prefix cannot be the same as the PSTN access code for external calling or the first digit of an internal extension.</p> <p data-bbox="711 758 1500 829">When this feature is enabled, the Auto Attendant is updated to include an option for direct transfer to voice mail.</p> <p data-bbox="711 856 1500 961">When you enable or disable <b>Direct Transfer to Voicemail</b>, IP phones are restarted and softkeys are added or removed.</p> <p data-bbox="711 989 1490 1136">When <b>Direct Transfer to Voicemail</b> is enabled, IP phone users with the <b>TrnsferVM</b> softkey on their phones can transfer a call directly to a user or group voice mail box by following these steps:</p> <ol data-bbox="711 1163 1507 1310" style="list-style-type: none"> <li>1. Press the <b>TrnsferVM</b> softkey on their phone.</li> <li>2. Enter the user or group voice mail extension.</li> <li>3. Press the <b>TrnsferVM</b> softkey again to make the transfer.</li> </ol> <p data-bbox="711 1337 1419 1409">Phone users without a voicemail transfer softkey can transfer a call to voicemail by following these steps:</p> <ol data-bbox="711 1436 1500 1562" style="list-style-type: none"> <li>1. Press the <b>Trnsfer</b> softkey.</li> <li>2. Enter the voice mail transfer prefix, followed by the user's extension.</li> </ol> <p data-bbox="760 1589 1500 1705">For example, if the voice mail transfer prefix is 6 and you want to transfer to voice mail for extension 201, you would press <b>Trnsfer</b>, followed by 6201.</p>

Setting	Description
<p><b>Voicemail Notification</b></p> <p>Enable and configure global site settings for voice mail notifications.</p>	
<p><b>Enable Voicemail Notification</b></p>	<p>Voice mail message notification is disabled by default.</p> <p>You must check the Enable Voicemail Notification option before you can configure site settings for email and phone notifications or enable notifications for your users.</p> <p>Disabling voice mail notifications. If voice mail notifications are currently enabled and you uncheck this option, the CCA will reset the notification settings.</p>
<p><b>Notification Schedule</b></p>	<p>Choose when the system will send the notification:</p> <ul style="list-style-type: none"> <li>▪ Click <b>8 AM to 5 PM</b> Monday to Friday</li> </ul> <p>Or</p> <ul style="list-style-type: none"> <li>▪ Click <b>24 Hours</b> a day 7 days a week.</li> </ul>
<p><b>Email Notification</b></p>	<p>Configure these settings to enable and configure voice mail notifications via email.</p> <ul style="list-style-type: none"> <li>▪ Check the <b>Enable Email Notification</b> option to enable voice mail notifications via email for the site.</li> <li>▪ In the <b>Outgoing Email Reply-To Address:</b> field, enter the email address that will appear in the From: field for email notifications sent from the voice mail system.</li> <li>▪ In the <b>SMTP Server Address field</b>, enter the hostname or IP address of the SMTP server that the voice mail system will use to send the text notifications. In order to use a hostname for this setting, <i>DNS must be enabled</i>.</li> <li>▪ Enter the <b>SMTP Server Port</b> number.</li> <li>▪ If the SMTP server requires authentication, check the <b>Require Authentication</b> option and enter the username and password for the SMTP server.</li> </ul>

Setting	Description
<b>Phone Notification</b>	The <b>Allow Notification Recipients to Access Mailbox Login</b> option must be checked if you want to enable sending of voice mail message notifications to phones.  This option is disabled by default.

### Mailboxes

From the mailboxes tab you can view storage and summary information for personal and group mailboxes.

Configure mailbox settings as described below, then click **OK** after making changes.

Field	Description
<b>Storage</b>	Available and used voice mail storage, in minutes, for the system.
<b>Summary</b>	Summary information for each voice mailbox.
<b>Name (User ID)</b>	Phone user ID, group ID (for example, hunt1 or blast1), or Share Line, for the selected mailbox.
<b>Extension</b>	User extension, hunt or call blast group pilot extension, or share line extension for the selected mailbox.
<b>Mailbox</b>	Mailbox status, either Enabled or None.
<b>Size</b>	Mailbox size, in minutes.



Field	Description	
<b>Mailbox Parameters of</b>	View or edit mailbox settings for the selected voice mailbox.	
	<b>Extension</b>	If this is a personal mailbox, this field displays the user extension associated with this mailbox.
	<b>Type</b>	<p>Personal or GDM (General Delivery Mailbox).</p> <p>You can change a GDM mailbox that is created for a shared extension to a Personal (Share) mailbox by changing the Type to Personal and choosing a user from the drop-down list. Only users with the shared extension that do not currently have an enabled Personal voice mailbox are listed.</p> <p>A Personal (Share) mailbox cannot be changed to a GDM mailbox. If the mailbox Type for a shared extension is Personal (Share), the only way to change it to a GDM is to delete the user associated with the Personal (Share) mailbox, apply the configuration, and then re-create the user.</p>
<b>Size</b>	View or edit the amount of storage allocated to this mailbox, from 4 to 90 minutes. The default is 12 minutes.	

### Notifications

If voice mail notifications are enabled and configured for this site, the options on the Notifications tab allow you to select extension that have a voice mail box and configure settings for email and phone notifications.

Voice mail and fax message notifications can be sent to a phone (for example, the user's home phone, cell phone, or other work number) or to their email inbox.

For each user, you can:

- Choose whether to enable notifications via phone, email, or both.
- Choose whether voice messages and faxes are attached to notification emails (faxes are attached as .TIFF-format files).

- Specify a separate notification level for phone and email notifications. You can choose whether to send notifications for all voice mail messages or only for messages marked Urgent by the sender. The Urgent option applies only to voice mails, not to faxes.

The following voice mail notification features are not supported by CCA:

- Notification schedule
- Notification message prefix and suffix text
- Connection timeout
- Restriction table for specifying the phone numbers that voice mail users can use for sending message notifications
- Cascading message notification

To add voice mail notification users or edit notification settings for existing users, follow these steps.

- 
- STEP 1** Choose **Configure > Telephony > Users and Extensions > Voicemail** and select the Notifications tab.
- STEP 2** If you are adding a new user and extension, click **Add**.
- STEP 3** To edit settings for an existing user and extension, select a user from the list and click **Edit**.
- STEP 4** Configure settings as described in [Add or Edit Notification User, page 354](#).
- STEP 5** Click **OK**.
- 

### Add or Edit Notification User

The Add/Edit Notification User dialog appears when you click **Add** or **Edit** from the Notification tab in the Voicemail window (**Configure > Telephony > Users and Extensions > Voicemail**).

To configure settings for voice mail notification via email and phone for an extension, configure described below, then click **OK**.

Setting	Description
<b>Extension</b>	Choose an available extension from the drop-down list. Only extensions that have a voice mailbox are listed. These can be personal voice mailboxes or group (GDM) mailboxes.
<b>Username (read-only)</b>	When you choose an extension, the user's first and last name and their user ID appears here. If it is a share extensions, Share Line is displayed here.
<b>Email Notification</b>	
Configure voice mail and fax notifications via email for the voice mailbox associated with this extension.	
<b>Notify User of New Voicemail via Email</b>	When this option is checked, notification of new voice mail messages or faxes via email is enabled for this user.
<b>Email Address</b>	Enter the email address to which notifications are sent. The email address can contain up to 129 characters.
<b>Attachment</b>	<p>When the <b>Attach Voicemail File to Email Message</b> option is checked, the voice mail message or fax is attached to the notification email. Each voice mail message is attached as a .wav file. The .wav file format is G711 mu-law, 8 KHz, 8-bit mono. Faxes are attached in .TIFF file format.</p> <p>This setting is disabled by default. Private messages are never attached to notification e-mails.</p>

Setting	Description
<b>Notification Level</b>	<p>Choose one of these notification levels:</p> <ul style="list-style-type: none"> <li>▪ Urgent Voicemail Only (does not apply to faxes).</li> <li>▪ All Voicemail. Choose this option if T.37 Fax to Mail is configured for your system and you want users to be notified of incoming faxes via email with the fax attached to the email.</li> </ul>
<b>Phone Notification</b>	
<b>Notify User of New Voicemail via Phone</b>	When this option is checked, notification of new voice mail messages or faxes via phone is enabled for this user.
<b>Phone Type</b>	<p>Choose one of these phone types:</p> <ul style="list-style-type: none"> <li>▪ Cell phone</li> <li>▪ Home phone</li> <li>▪ Work phone</li> </ul>
<b>Phone Number</b>	<p>Enter the phone number to which the notifications will be sent.</p> <p>When specifying an external number, be sure to include any access codes, if needed.</p>
<b>Extra Digits</b>	<p>The system dials these digits when the outgoing call is answered. These digits are treated as DTMF digits. For example, extra digits may be used when sending calls to a pager or automated answering system.</p> <p>You can specify up to 64 extra digits. Extra digits can consist of digits from 0 to 9, # (pound), asterisk (*), and plus sign (+).</p>

Setting	Description
<b>Notification Level</b>	<p>Choose one of these notification levels:</p> <ul style="list-style-type: none"> <li>▪ Urgent Voicemail Only (does not apply to faxes).</li> <li>▪ All Voicemail. Choose this option if T.37 Fax to Mail is configured for your system and you want users to be notified of incoming faxes via email with the fax attached to the email.</li> </ul>

## Single Number Reach (SNR)

This window appears when you choose **Configure > Telephony > Users and Extensions > Single Number Reach** from the feature bar.

Single Number Reach (SNR) provides users with the ability to be reached on two numbers: a regular extension on their IP phone, and a PSTN number. BRI, PRI, FXO, and SIP interfaces are supported.

**NOTE** For SNR numbers going over SIP trunks, the Caller ID may not reflect the Caller ID of the original caller, because the Caller ID is determined by the ITSP. The Caller ID will usually be the station or the main PSTN number configured for SIP trunk. Most ITSPs require Caller IDs that are mapped explicitly to their accounts in order to prevent fraud. If the Caller ID for the original caller is not overridden with the Caller ID required by the ITSP, the call to the SNR number will fail.

- [Overview](#)
- [Limitations](#)
- [SBCS Platform Requirements](#)
- [Configuration Procedures and Settings](#)

### Overview

The Single Number Reach (SNR) feature allows phone users to answer incoming calls on their desktop IP phone or at a remote destination, such as a mobile phone, and to pick up in-progress calls on the desktop phone or the remote phone without losing the connection. This allows callers to use a single number to reach the phone user. Calls that are not answered can be forwarded to voice mail.

Remote destinations may include these devices:

- Mobile (cellular) phones
- Smart phones
- IP phones not belonging to the same Cisco Unified CME router as the desktop phone
- Home phone numbers in the PSTN
- Supported PSTN interfaces include PRI, BRI, SIP, and FXO.

For incoming calls to the SNR extension, Cisco Unified CME rings the desktop IP phone first. If the IP phone does not answer within the configured amount of time, it rings the configured remote number while continuing to ring the IP phone. Unanswered calls are sent to a configured voice mail number.

The IP phone user has these options for handling calls to the SNR extension:

- **Pull back the call from the remote phone.** Manually pull back the call to the SNR extension by pressing the **Resume** soft key, which disconnects the call from the remote phone.
- **Send the call to the remote phone.** Send the call to the remote phone by using the **Mobility** softkey. While connected to the call, the phone user can press the **Mobility** softkey and select “Send call to mobile.” The call is forwarded to the remote phone.
- **Enable or disable Single Number Reach.** While the IP phone is in the idle state, the user can toggle the SNR feature on and off by using the **Mobility** softkey. If the user disables SNR, the system does not ring the remote number.

IP phone users can modify their own SNR settings directly from the phone by using the menu available with the **services** feature button. You must enable the feature on the phone to allow a phone user to access the user interface.

### Limitations

The following limitations apply to SNR configuration and features:

- Each IP phone supports only one SNR number.
- Concurrent use of SNR and T.37 Fax Detection application is not supported.
- You cannot configure SNR on an extension that is a member of a hunt group.
- The SNR feature is not supported for the following:
  - SCCP-controlled analog FXS phones

- Video calls
- SCCP phones that do not have softkeys. In some cases, SNR may be configured on these phones, but since there are no softkeys, the Mobility feature cannot be used.

For more information about the SNR feature and limitations, see the *Cisco Communications Manager Express System Administrator Guide*, available on Cisco.com at the following URL:

[www.cisco.com/en/US/docs/voice\\_ip\\_comm/cucme/admin/configuration/guide/cmeadm.html](http://www.cisco.com/en/US/docs/voice_ip_comm/cucme/admin/configuration/guide/cmeadm.html)

### SBCS Platform Requirements

This feature is supported on CME 7.1, available with UC500 software pack version 7.1.1-EA or later.

### Configuration Procedures and Settings

To enable SNR for one or more phone users or edit settings for SNR users, follow these steps.

- 
- STEP 1** Choose **Configure > Telephony > Users and Extensions > Single Number Reach** from the feature bar.
  - STEP 2** Click **Add** or **Edit**. The Add SNR User or Modify SNR User window appears.
  - STEP 3** Configure SNR user settings as described in the section **Adding an SNR User, page 360** or the section **Modifying an SNR User, page 361**.
  - STEP 4** Click **OK**.
-

## Adding an SNR User

This window appears when you click **Add** from the Single Number Reach window.

To add an SNR user, follow these steps.

**STEP 1** Configure these settings for each SNR user.

Setting	Description
<b>User Name</b>	Select a user from the drop-down list.
<b>MAC Address</b>	<i>Read-only.</i> This field displays the MAC address of the phone associated with the user extension that you select when creating the SNR user.
<b>Extension</b>	<p>When you select a user, the drop-down menu lists available extensions on the user's phone that can be used for SNR.</p> <p>If the extension you choose is a share line, the text (Share Line) appears to the right of the extension.</p> <p>Select the extension on the user's phone to use for SNR. If the user selected already has SNR configured on an extension on their phone, a warning msg is displayed. Only one extension per phone can be configured for SNR.</p>
<b>Remote Destination</b>	<p>Enter or edit the phone number for the remote destination.</p> <p>When entering the remote destination phone number, enter the number exactly as you would dial it, including any access codes, long distance dialing code, and any other required dialing digits.</p>
<b>Delay and Timeout Settings</b>	
<b>Delay Before Dialing Remote Destination (sec)</b>	The delay specifies the number of seconds that the call rings the IP phone before ringing the remote phone. Enter a number from 1 to 10 seconds. The default value is 5 seconds.



Setting	Description
<b>Call Forward to Voice Mail Delay (sec)</b>	Number of seconds to let the call ring on the IP phone and remote phone before transferring the call to voice mail. Enter a number from 5 to 60 seconds. The default value is 30 seconds.

**STEP 2** Click **OK**.

## Modifying an SNR User

This dialog appears when you click **Edit** on the SNR window (**Configure > Telephony > Users and Extensions > Single Number Reach**).

You can edit the remote destination number and SNR timeout settings only.

If you want to change the extension associated with an SNR user, you must remove the SNR user, re-add the SNR user, and select a different extension.

To modify SNR user settings, follow these steps.

**STEP 1** Modify SNR user settings as described in the following table.

Setting	Description
<b>User Name</b>	<i>Read-only.</i> This field displays the first and last name of the user associated with this extension.
<b>MAC Address</b>	<i>Read-only.</i> This field displays the MAC address of the phone associated with this SNR user extension.
<b>Extension</b>	<i>Read-only.</i> This field displays the extension that you selected when adding this SNR user.
<b>Remote Destination</b>	Edit the phone number for the remote destination.  When editing the remote destination phone number, enter the number exactly as you would dial it, including any access codes, long distance dialing code, and any other required dialing digits.

Setting	Description
<b>Share Line Members</b>	Read-only. If the extension is a share line, this displays the list of users.
<b>Delay and Timeout Settings</b>	
<b>Delay Before Dialing Remote Destination (sec)</b>	The delay specifies the number of seconds that the call rings the IP phone before ringing the remote phone. Enter a number from 1 to 10 seconds. The default value is 5 seconds.
<b>Call Forward to Voice Mail Delay (sec)</b>	Number of seconds to let the call ring on the IP phone and remote phone before transferring the call to voice mail. Enter a number from 5 to 60 seconds. The default value is 30 seconds.

**STEP 2** Click **OK**.

## System Speed Dials

To configure System Speed Dials, choose **Configure > Telephony > Users and Extensions > System Speed Dial** from the feature bar.

From the System Speed Dial window, you can set local speed dial numbers.

### Overview

A list of frequently called numbers can be created for all phones. A phone user can quickly dial a number from a list by using a speed-dial number.

Phone users access these speed dials from the **Local Services > Local Speed Dial** menu on their phone.

You can add, edit, or delete speed-dial entries. The list entries can be moved up or down the list and appear on the telephone display in the order in which they are listed. A maximum of 32 frequently called numbers can be defined in the list.

### Procedures

To enable a local speed-dial menu for all IP phones, perform the following steps:

- 
- STEP 1** Click **Add**.
  - STEP 2** In the **Name** field, enter the name of the speed dial.
  - STEP 3** In the **Phone Number** field, enter the number for the speed dial.
  - STEP 4** To reorder a local speed-dial number in the list, select the entry, and click the up arrow or the down arrow. The numbers are listed in the order in which they are displayed on the phone.
  - STEP 5** To remove a local speed-dial number from the menu, select the entry in the menu, and click **Delete** in the Local Speed Dials box.

If the list has reached the maximum number of entries allowed, the **Add** button is disabled.

---



## Phone Groups

This section provides instructions for configuring these types of phone groups:

- **Hunt Groups**
- **Call Blast Groups**
- **Call Pickup Groups**
- **Paging Groups**

To configure phone groups, choose **Configure > Telephony > Phone Groups** from the feature bar.

### Hunt Groups

To configure hunt groups, choose **Configure > Telephony > Phone Groups > Hunt Groups** from the feature bar.

#### Overview

Use hunt groups to manage distribution of incoming calls to a pre-defined group of extensions (members). The hunt group type determines the order in which members of the hunt group receive calls.

Up to 10 hunt groups can be configured on the system. Each hunt group must have at least one member and can contain up to 32 members.

Once you configure hunt groups, they are available to be selected as destinations for inbound call routing, Auto Attendant, call forward destinations, and other telephony features.

When you configure a hunt group, the **HLog** softkey is added to member phones. Hunt group members can log in or out of the group using the **HLog** softkey. The **HLog** softkey is displayed on the hunt group member phone when an incoming call to the hunt group rings their phone. Users can also access this softkey from the main phone screen by pressing the **more** softkey. The **HLog** softkey replaces the use of DnD (Do Not Disturb). DnD is less flexible, since it makes the subscriber unavailable for all calls, not just hunt group calls.

### Limitation

The following limitation applies to Hunt Groups configuration:

- A phone that has SNR enabled cannot be a member of a hunt group.

### Procedures

To enable and configure a hunt group, configure settings as described below, then click **OK** or **Apply**.

Setting	Description
<b>Enable</b>	When this box is checked, the associated hunt group is enabled.
<b>Pilot #</b>	Pilot number for this hunt group. This is the extension that is dialed to reach the hunt group. Use the default extension for the pilot number or click in the field and edit it.
<b>Description</b>	<i>Optional.</i> Text description that identifies this hunt group. This description is only used in the Hunt Group window. In other parts of the CCA user interface, the hunt group is identified by its number and pilot extension, for example, hunt1 (502).

Setting	Description
<b>Hunt Type</b>	<p>Determines the order in which calls are received by members of the hunt group. Choose one of the following options:</p> <ul style="list-style-type: none"> <li>▪ <b>Sequential</b>—Call hunting always starts with the pilot number for the group and continues to each number in the group in the order in which they are listed, from top to bottom, in the Members list.</li> <li>▪ <b>Longest Idle</b>—Calls go to the directory number that has been idle for the longest time, according to the time stamp of the most recent call to the hunt group taken by that extension. If that extension is unavailable, the search continues to the next extension in the group.</li> <li>▪ <b>Peer</b>—Hunt group in which the first number called is selected round-robin from the list.</li> </ul>
<b>Members</b>	<p>Define the members of the Hunt Group. These are all the numbers that can ring when a call comes in to the pilot number.</p> <ol style="list-style-type: none"> <li>1. Click <b>Members</b> to display the list of Available and Selected users at the bottom of the Hunt Groups window.</li> <li>2. Use the <b>Add</b> and <b>Remove</b> arrow buttons to move items between the list of Available and Selected members. Use CTRL-click and SHIFT-click to select multiple members to move between lists.</li> <li>3. Use the <b>Up</b> and <b>Down</b> arrows to specify the order in which calls are routed to the Hunt Group.</li> </ol>
<b>Timeout (sec)</b>	<p>Number of seconds after which an unanswered call is redirected to the next number in a voice hunt-group list, from 5 to 20 seconds.</p>
<b>No Answer Forward To</b>	<p>Destination for forwarding unanswered calls for the hunt group. You can choose <b>None</b>, <b>Auto Attendant</b>, <b>Voice Mail</b>, <b>Extension</b>, <b>Hunt Group</b>, <b>Blast Group</b>, <b>B-ACD</b>, or <b>Other Number</b>.</p> <p>If you select <b>Voice Mail</b> as the destination for <b>No Answer Forward To</b>, a General Delivery Mailbox (GDM) is created for the group. To view GDM mailbox information or change the size of the mailbox, go to <b>Configure &gt; Telephony &gt; Voicemail</b> window and select the <b>Mailboxes</b> tab.</p>

## Call Blast Groups

To configure Call Blast Groups, choose **Configure > Telephony > Phone Groups > Call Blast Groups** from the feature bar.

### Overview

A call blast group is a special type of phone group in which calls to a specified pilot number simultaneously ring multiple phones. This feature can also be used to set up a Single Number Reach scenario in which a call to a user's phone extension simultaneously rings another number (for example, a cell phone number or home phone number) or a different extension.

Up to 10 call blast groups can be configured on the system. Each call blast group must have at least two members and can contain up to 32 members.

Once you configure call blast groups, they are available to be selected as destinations for inbound call routing, Auto Attendant, call forward destinations, and other telephony features.

When you configure a call blast group, the **HLog** softkey is added to member phones. Hunt group members can log in or out of the call blast group using the **HLog** softkey. The **HLog** softkey is displayed on all call blast group member phone when an incoming call is directed to the group. Users can also access this softkey from the main phone screen by pressing the **more** softkey. The **HLog** softkey replaces the use of DnD (Do Not Disturb). DnD is less flexible, since it makes the subscriber unavailable for all calls, not just call blast group calls.

### Procedures

To enable and configure a call blast group, configure settings as described below, then click **OK** or **Apply**.

Setting	Description
<b>Enable</b>	When this box is checked, the associated call blast group is enabled.
<b>Pilot #</b>	Pilot number for this call blast group. This is the extension that is dialed to reach the call blast group. Use the default extension for the pilot number or click in the field and edit it.



Setting	Description
<p><b>Members</b></p>	<p>Define the members of the call blast group. These are all the numbers that will ring when a call comes in to the pilot number.</p> <ol style="list-style-type: none"> <li>1. Click <b>Members</b> to display the list of Available and Selected users at the bottom of the Call Blast Groups window.</li> <li>2. Use the <b>Add</b> and <b>Remove</b> arrow buttons to move members between the list of Available and Selected members. Use CTRL-click and SHIFT-click to select multiple members to move between lists.</li> </ol> <p>To add an external PSTN number (for example, a cell phone number or home phone number) to the list of Available members and move it to the Selected list:</p> <ol style="list-style-type: none"> <li>1. In the <b>Other Number</b> field, enter the phone number exactly as you would dial it, including any access codes (up to 16 digits).</li> <li>2. Click the <b>Add</b> button to the right of the <b>Other Number</b> field to move it to the Available list.</li> <li>3. Click the <b>Add</b> arrow button to move the Other Number you just added to the Selected list.</li> </ol> <p>To remove an external number from the Selected list, click the <b>Remove</b> arrow button to move it back to the Available list.</p> <p>Once you close the Call Blast Groups window or select a different Call Blast Group to configure, any external numbers added to the Available list but not moved to the Selected list are removed from the Available list. When you next open the Members selection list, these external phone numbers do not appear in the Available list.</p>
<p><b>Timeout (sec)</b></p>	<p>Number of seconds after which an unanswered call is redirected to the destination specified by <b>No Answer Forward To</b>, from 5 to 20 seconds. The default Timeout is 16 seconds.</p> <p><b>IMPORTANT</b> The <b>Timeout</b> value for the Call Blast group must be lower than the CFNA Timeout value for any of its member extensions. You may need to lower the Timeout value for a Call Blast Group or raise the CFNA timeout value for member extensions to ensure that this requirement is met.</p>

Setting	Description
<b>No Answer Forward To</b>	<p>Destination for forwarding unanswered calls for the hunt group.</p> <p>You can choose <b>None</b>, <b>Auto Attendant</b>, <b>Voice Mail</b>, <b>Extension</b>, <b>Hunt Group</b>, <b>Blast Group</b>, or <b>Other Number</b>.</p> <p>If you select <b>Voice Mail</b> as the destination for <b>No Answer Forward To</b>, a General Delivery Mailbox (GDM) is created for the group. To view GDM mailbox information or change the size of the mailbox, go to <b>Configure &gt; Telephony &gt; Voicemail</b> window and select the <b>Mailboxes</b> tab.</p>
<b>Number</b>	<p>Number for the selected destination type selected for <b>No Answer Forward To</b>:</p> <ul style="list-style-type: none"> <li>▪ If you selected <b>Auto Attendant</b>, and multiple Auto Attendants are configured for the site, select the desired Auto Attendant.</li> <li>▪ If you selected <b>Other Number</b>, enter the number in the <b>Number</b> field exactly as you would dial it, including any access codes.</li> <li>▪ If you selected <b>Extension</b>, select an extension from the list displayed in the <b>Number</b> field.</li> <li>▪ If you selected <b>Hunt Group</b>, or <b>Blast Group</b>, or select an group from the list displayed in the <b>Number</b> field.</li> </ul>

## Call Pickup Groups

To configure Call Pickup groups, choose **Configure > Telephony > Phone Groups > Call Pickup Groups** from the feature bar.

### Overview

Create pickup groups to configure a group of user extensions that can retrieve calls ringing on extensions belonging to members of the same pickup group by pressing the **GPickUp** softkey on the IP phone and pressing the \* key.

The following notes apply to using Call Pickup features on SBCS platforms:

- Any phone user can pick up a ringing call by pressing the PickUp softkey on their phone and dialing the ringing extension. No configuration is needed.

- Any phone user can pick up a call ringing on a group pick-up extension by pressing the **GPickUp** softkey on their phone and dialing the group pick-up extension.
- If the user's phone and the ringing extension are in the same Call Pickup group, the phone user can retrieve the call by pressing the **GPickUp** softkey, then the \*(star) key on their phone. If there is only one Call Pickup group configured on the system, the user is automatically connected and does not have to press the \* key.

### Procedures

To enable and configure a pickup group, configure members as described below, then click **OK** or **Apply**.

Setting	Description
<b>Members</b>	Define the extensions that are members of the pickup group. <ol style="list-style-type: none"><li>1. Click <b>Members</b> to display the list of Available and Selected extensions at the bottom of the Pickup Groups window.</li><li>2. Use the <b>Add</b> and <b>Remove</b> arrow buttons or the <b>Select All</b> buttons to move extensions between Available and Selected lists. Use CTRL-click and SHIFT-click to select multiple extensions to move between lists.</li></ol>

## Paging Groups

To configure paging groups, choose **Configure > Telephony > Phone Groups > Paging Groups** from the feature bar.

Paging Group configuration is described in these sections:

- [Overview, page 372](#)
- [Creating a Simple Paging Group \(Individual Phones Only\), page 373](#)
- [Creating a Combined Paging Group, page 373](#)
- [Editing a Paging Group, page 374](#)
- [Deleting a Paging Group, page 375](#)
- [Paging Group Dependency View, page 377](#)

### Overview

You can create paging groups to allow phone users to broadcast announcements to groups of Cisco IP phones by using the phone speakers. You can create up to 10 paging groups.

Only Cisco IP phones can be members of paging groups.

You can also configure combined paging groups. A combined paging group can contain other paging groups as members or a combination of individual phones and other paging groups. For example, a phone in a real estate office may need to receive pages going to the property management department, while a different phone needs to receive pages going to the sales department. In addition, both phones need to receive pages sent to all employees.

The process for configuring a combined paging group has these general steps:

1. First, create each of the individual paging groups required and assigned phones to them.
2. Create the combined paging group and add individual phones that are members of the combined group only.
3. Add the individual paging groups you created in step 1 to the combined paging group.

A paging group can be a member of multiple paging groups, but a phone can be assigned to only one paging group. One level of nesting is supported for combined paging groups. See [Nested Paging Groups, page 375](#) for some examples.

---

### Creating a Simple Paging Group (Individual Phones Only)

To enable and configure a paging group that contains one or more individual phones, follow these steps.

- 
- STEP 1** Enable configuration for the group you want to create by checking the **Enable** option.
- STEP 2** In the **Paging #** field, enter the extension to use for the paging group or accept the default extension. The default extension range for paging groups is 101 through 110.
- This is the extension that is dialed to reach the paging group.
- STEP 3** *Optional.* Enter a **Description** that identifies this paging group. This description is used only in the Paging Groups window and is not displayed on phones.
- STEP 4** Add member phones to the paging group.
- Click the Phones tab at the bottom of the page. The Available list displays the user ID and MAC address for each phone that is not currently part of a paging group.
  - Click on a user ID in the **Available** list and use the **Add** and **Remove** buttons to move members to and from the **Selected** list. You can also use the CTRL-click and SHIFT-click shortcuts to select multiple phones to move between lists.
- STEP 5** Click **OK** or **Apply** to create the paging group.

The Members column updates to show the number of phones that are part of the group.

---

### Creating a Combined Paging Group

To create a paging group that contains other paging groups, follow these steps.

- 
- STEP 1** Create the paging groups that you want add as members to the combined group and identify individual phones that will be part of the combined group.
- See [Creating a Simple Paging Group \(Individual Phones Only\), page 373](#).
- STEP 2** Enable configuration of the combined group by checking the **Enable** option for the new group.

**STEP 3** In the **Paging #** field, enter the extension to use for the paging group or accept the default extension. The default extension range for paging groups is 101 through 110.

This is the extension that is dialed to reach the paging group.

**STEP 4** *Optional.* Enter a text description that identifies this paging group. This description is used only in the Paging Groups window and is not displayed on phones.

**STEP 5** Add paging groups and phones to the paging group.

a. To add phones, click the **Phones** tab at the bottom of the page. The Available list displays the user ID and MAC address for each phone that is not currently part of a paging group.

Click on a user ID in the Available list and use the **Add** and **Remove** buttons to move members to and from the Selected list.

b. To add paging groups as member, click the **Groups** tab at the bottom of the page. Choose group from the Available list and use the **Add** and **Remove** buttons to move groups to and from the Selected list.

A paging group can be a member of multiple paging groups, but a phone can be assigned to only one paging group.

You can use the CTRL-click and SHIFT-click shortcuts to select multiple phones or groups.

The Members column updates to reflect the number of phones and paging groups that are part of the group.

**STEP 6** *Optional.* To view dependencies between groups or check for configuration problems in combined paging groups, click **Show Group Dependency**. See [Paging Group Dependency View, page 377](#).

**STEP 7** Click **OK** or **Apply**.

---

### Editing a Paging Group

To edit a paging group, click the **Phones (n) and Groups (n)** button for the group you want to edit.

The Phones and Groups tabs update to display Available and Selected phones and groups for the paging group to be edited.

Use the **Add** and **Remove** buttons to edit the group members, then click **OK** or **Apply**.

### Deleting a Paging Group

To delete a paging group, uncheck the **Enable** setting that corresponds to the group you want to delete and click **OK** or **Apply**.

Before removing a group, you can click **Show Group Dependency** to see which groups are members of other groups.

**TIP** If the group you delete is part of a combined paging group, it is automatically removed from the combined paging group. In this case, you may want to update the Description you entered for the combined paging group to reflect the change.

### Nested Paging Groups

Combined (“nested”) paging groups are supported up to one level deep.

The following scenario illustrates combined paging groups with one level of nesting:

- Assume paging group 1 contains only phones, paging group 2 contains only phones, and paging group 3 contains paging groups 1 and 2 and some phones. In this scenario, there is one level of nesting.
- A paging call to group 3 reaches all phones in groups 1, 2, and 3.

The paging group dependency view for this scenario is shown below:

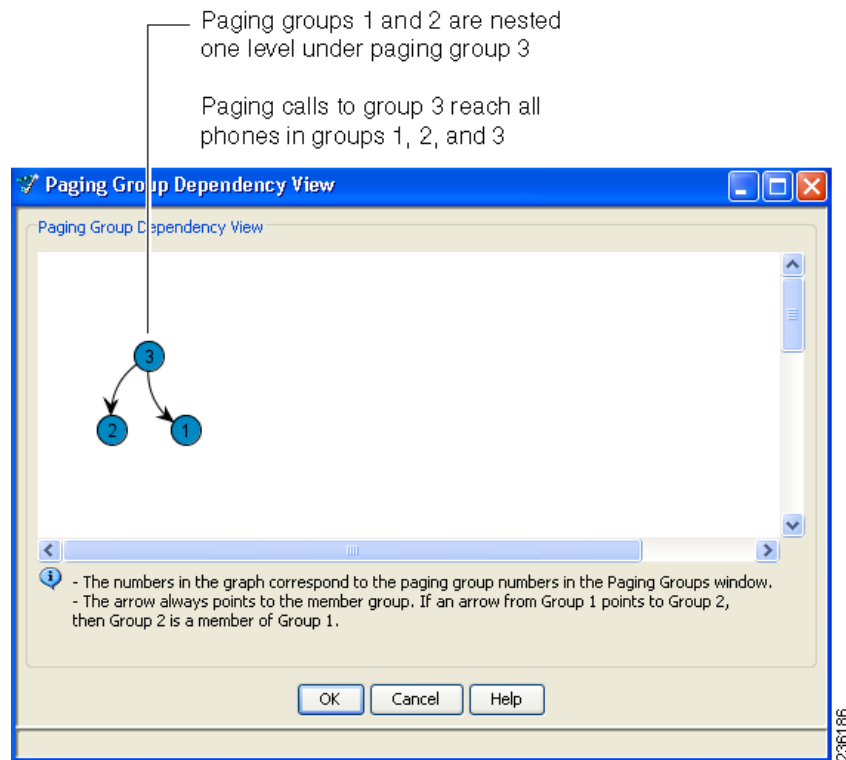

The following scenario illustrates combined paging groups with two levels of nesting:

- Assume paging group 1 contains paging group 2 and paging group 2 contains paging group 3. In this scenario, there are two levels of nesting.
- A paging call to group 1 reaches all phones in groups 1 and 2 but does not reach the phones in group 3.



The paging group dependency view for this scenario is shown below:

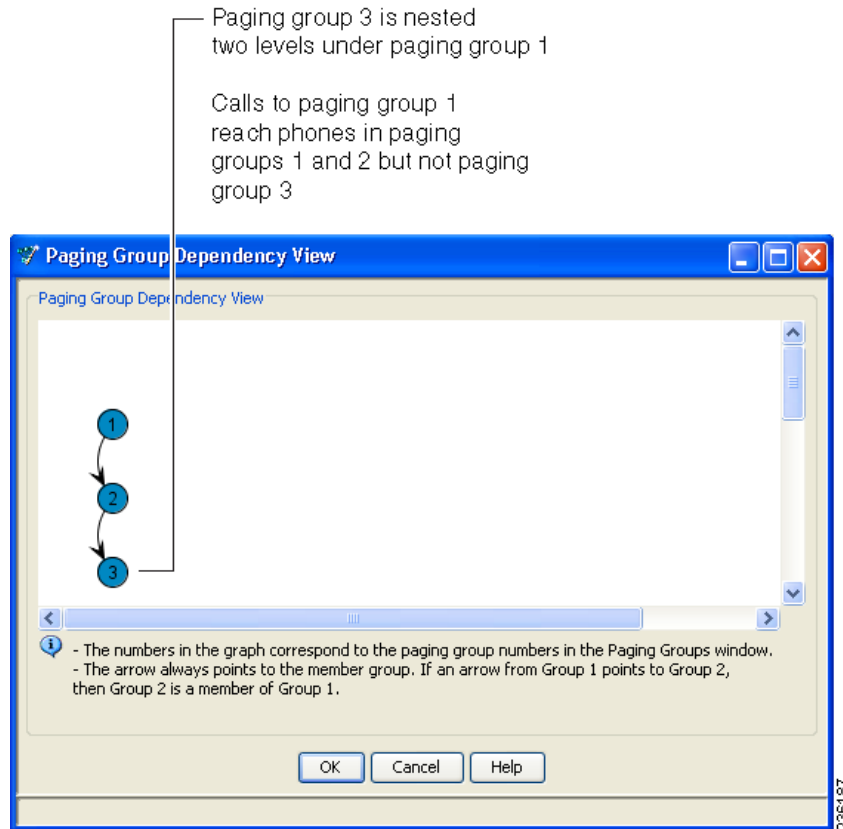

## Paging Group Dependency View

The Paging Group Dependency window appears when you click **Show Group Dependency** in the Paging Groups window (**Configure > Telephony > Phone Groups > Paging Groups**).

This window displays a graph that can help you to quickly see which paging groups are members of other paging groups. As shown in the example below:

- The numbers in the view correspond to the number of the paging group listed in the Paging Groups window.
- The arrows in the view indicate which groups are members of other groups. The arrow always points to the member group.

Some sample paging group dependency view graphs are shown below.

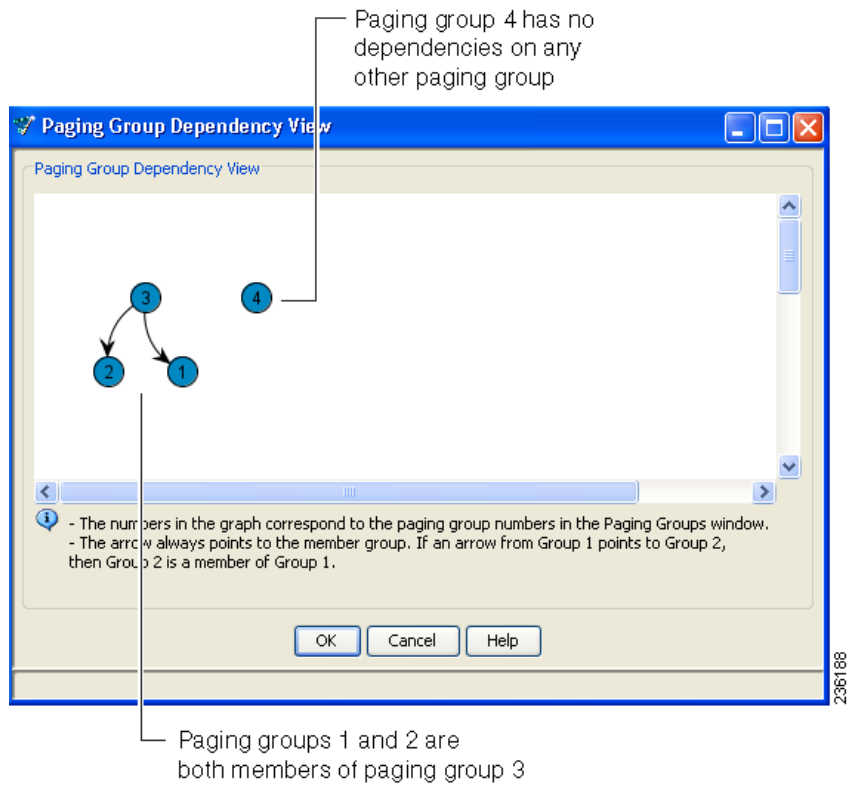

## Voice Features

The topics in this section provide instructions for configuring these voice features:

- **Call Park**
- **Conference**
- **Conference Barge**
- **Music on Hold (MoH)**

**IMPORTANT** Telnet access must be enabled in order to configure voice features.

### Call Park

To configure call park, choose **Configure > Telephony > Voice Features > Call Park** from the feature bar.

#### Overview

Call Park provides temporary holding locations for incoming calls. When a call is parked, it is transferred to the call park extension and put on hold until it is retrieved by another employee. The message *Call Park <call park extension>* displays on the phone that parked the call. To retrieve a parked call, other users can dial the park slot extension.

- A 1-second reminder ring occurs at the specified reminder interval and the message “*Call Park <extension>*” re-appears on the LCD display of the phone that parked the call. The reminder ring and message are sent only to the phone that parked the call.
- You can choose to enable Timeout and Recall settings to specify the action to take when the call park timeout is reached. The call park timeout is equal to the number of retries multiplied by the number of seconds in the reminder interval). The call can be transferred to the extension that parked the call, transferred to another extension, or disconnected.

When Timeout and Recall is enabled, you also set the number of reminders,

reminder interval, retry delay, and number of retries. After the timeout expires, the call park timeout action is taken.

### Limitations and Guidelines

These limitations and guidelines apply to Call Park:

- Only one call can be parked at each call park slot extension.
- Phones without softkeys cannot be used to park calls.

### Procedures

To create a new call park slot, click **Create**, complete settings as described in the section [Creating or Editing a Call Park Slot, page 380](#). In the Call Park window, click **OK** or **Apply** to send the configuration to the UC500.

To edit a call park slot, click on a call park slot in the list to select it, click **Modify**, and edit the settings as described in the section [Creating or Editing a Call Park Slot, page 380](#). In the Call Park window, click **OK** or **Apply** to send the configuration to the UC500.

To delete a call park slot, click on a call park slot in the list to select it, click **Delete**, and choose **OK** when you are prompted to confirm the deletion. In the Call Park window, click **OK** or **Apply** to send the configuration to the UC500.

## Creating or Editing a Call Park Slot

To create or modify a Call Park slot, follow these steps.

- 
- STEP 1** In the **Extension** field, enter the extension to use for this park slot.
  - STEP 2** In the **Slot Label** field for each new park slot extension, enter a description for each park slot.
  - STEP 3** If needed, check the **Enable Timeout and Recall** option to enable the call park timeout and recall feature.

**STEP 4** If **Enable Timeout and Recall** is checked, configure these settings.

Setting	Description
<b>Reminder Interval (sec)</b>	Number of seconds to wait between call park reminders. The default reminder interval is 120 seconds.
<b>Number of Reminders</b>	Number of call park reminders to send to the phone that parked the call. The default number of reminders is 2.  The call park timeout is the number of retries multiplied by the number of seconds in the reminder interval. For example, if you set the reminder interval to 20 seconds and the number of retries to 3, a call can be parked up to 60 seconds before the timeout expires and the timeout expiration action is taken.
<b>When Timeout Expires</b>	Specify the action to take after the call park timeout expires. Choose one of these options: <ul style="list-style-type: none"> <li>▪ <b>Recall to extension that parked the call</b> (this is the default).</li> <li>▪ <b>Transfer to extension.</b> If you choose this option, enter the <b>Transfer Extension</b>, set the <b>Retry Delay</b>, and specify the <b>Number of Retries</b>.</li> <li>▪ <b>Disconnect call.</b></li> </ul>
<b>Transfer Extension</b>	If you the timeout expiration action is <b>Transfer to extension</b> , enter the extension here (for example, you could enter a hunt group pilot number or some other extension).
<b>Retry Delay (sec)</b>	Enter the number of seconds to wait between attempts to transfer a parked call. The number of attempts is specified in the <b>Number of Retries</b> setting. The default retry delay is 120 seconds.
<b>Number of Retries</b>	Enter the number of retries to allow when transferring a parked call. The default number of retries is 2.

**STEP 5** Click **OK**.

## Conference

To configure multiparty conferencing, choose **Configure > Telephony > Voice Features > Conference** from the feature bar.

For information about configuring conferencing, see these topics:

- [Overview, page 382](#)
- [Enabling and Configuring Multiparty \(MeetMe and Ad Hoc\) Conferencing, page 383](#)
- [Limitations and Notes that Apply to Multiparty Conferencing, page 385](#)
- [Conference Barge, page 385](#)

### Overview

From the Conference window, you can choose whether to enable Multi-party conferencing and configure conferencing options.

**NOTE** Multi-party conferencing must be enabled in order to use the Conference Barge (cBarge) and Privacy features.

When Multi-party conferencing is disabled:

- Software resources are used for conferencing.
- You can specify the maximum number of simultaneous 3-way calling sessions to allow on the system.

When Multi-party conferencing is enabled:

- Hardware resources (DSPs) are used.

Configuration Assistant automatically detects the UC500 platform you are configuring and automatically determines the maximum supported number of participants per conference and simultaneous conferencing sessions that can be configured for both Meet-Me and Ad Hoc conferencing.

Cisco UC500 platforms that support 24 or more users have approximately twice the amount of hardware conferencing resources and can support a greater number of participants and sessions.

**NOTE** Hardware conferencing is disabled if there are not enough hardware resources. For example, hardware conferencing may be disabled if a T1/E1 add-on card is added to an UC500-16U chassis, because voice ports consume resources that from the same pool of resources allocated for hardware conferencing.

- You can configure both MeetMe and Ad Hoc conferencing.
  - An *Ad Hoc conference* is a type of conference in which one party calls another and either party decides to add another party to the call.
  - A *MeetMe conference* is one in which the parties dial a pre-determined MeetMe conference number.

The conference creator goes off-hook, presses the **MeetMe** softkey on their phone, hears a confirmation tone, then dials the MeetMe number. Once the conference is initiated, other parties join the MeetMe conference by dialing the MeetMe number.

When you configure MeetMe conferencing, all phone users have permission to initiate MeetMe conferences. The MeetMe conference creator can press the **ConfList** softkey to list all participants, **RmLstC** softkey to remove the last caller that joined, and remove a party from a conference.

MeetMe conferencing softkeys are configured and applied to phones automatically when multiparty conferencing is enabled and MeetMe extensions are set up.

- You can enable or disable playing of tones when callers join or leave a multi-party conference. By default these are disabled.

### Enabling and Configuring Multiparty (MeetMe and Ad Hoc) Conferencing

To enable and configure multi-party conferencing, follow these steps.

**STEP 1** In the Conference window, choose whether to enable multiparty conferencing.

- Check the **Enable Multi-Party Conferencing** checkbox to enable multiparty conferencing (uses hardware resources).
  - When this option is selected, both Ad Hoc and MeetMe conferencing can be configured.
  - The maximum number of sessions that be configured depends on the number of hardware resources for the UC500 platform being configured.

- If you do not choose to enable multiparty conferencing, use the **Maximum 3-way Calling Sessions** pull-down menu to set the maximum number of simultaneous 3-party Ad Hoc conference sessions that you want to allow.
  - When this option is selected, Cisco IOS software resources are used for conferencing. Hardware resources are not required. This option is used when hardware conferencing is disabled or not configured.
  - Each Ad Hoc conferences can have up to 3 participants.

**STEP 2** If **Enable Multi-Party Conferencing** is checked, configure the following settings.

- a. Choose a **Mode**, either G711 (single mode) or G711/G729 (mixed mode).

The **Mode** setting determines the amount of hardware conferencing resources required per call. G711 uses fewer hardware conferencing resources than G711/G729.

G711 only mode is recommend for deployments where local trunks only are used. Mixed mode (G711/G729) is recommended for deployments that include SIP trunking, if the SIP Service Provider supports G729.

- b. Under **Tone Settings**, choose whether to enable or disable playing of tones when callers join or leave a multiparty conference.

By default, conference join and leave tones are disabled. When multi-party conferencing is disabled, tone settings are also disabled.

- c. Use the pull-down menu to select the **Maximum Participants** per conference.
- d. Use the slider bar to the right of the **Sessions** menu to allocate sessions between Ad Hoc and Meet-Me conferences. The total number of sessions must be equal to or less than the maximum number of simultaneous sessions.
- e. Edit Meet-Me extension numbers or leave the default values.

**STEP 3** Click **OK** or **Apply**.

---



### Limitations and Notes that Apply to Multiparty Conferencing

- If you are configuring a 8- or 16-user system with a VIC and hardware-based Ad Hoc conferencing is already configured on the device, before any VIC card is configured from CCA, Ad Hoc conferencing must be restored to software-based conferencing by unchecking **Enable Multiparty Conferencing** and clicking **Apply**.
- If any DSP-related out-of-band configuration exists (for example, transcoding), conferencing is not available. You must either remove the existing out-of-band configuration or continue to configure it out-of-band.

## Conference Barge

To configure Conference Barge (cBarge) and an optional Privacy button for cBarge phones, choose **Configure > Telephony > Voice Features > Conference Barge** from the feature bar.

**IMPORTANT** Multi-party conferencing must be enabled before you can configure cBarge and Privacy. Conference Barge can only be configured on IP phones that have at least one octal-line shared extension.

For information about cBarge and Privacy features, refer to these topics.

- [Conference Barge and Privacy Feature Descriptions, page 385](#)
- [cBarge and Privacy Usage and Examples](#)
- [Prerequisites for cBarge and Privacy, page 389](#)
- [Unsupported Phones, page 389](#)
- [Setting Up Shared Octal Line Extensions, page 390](#)
- [Configuring Conference Barge and Privacy Features, page 390](#)
- [Removing cBarge and Privacy for a User's Phone, page 391](#)

### Conference Barge and Privacy Feature Descriptions

The cBarge feature allows users with shared octal-lines on their phones to press the **cBarge** softkey to “barge in” and join a call in progress on that shared octal-line. When a third party joins the call, an Ad Hoc conference is created. Other users who also have cBarge configured for the same shared octal-line can join the conference, up to the maximum number of participants. These guidelines apply to the cBarge feature:

- **Maximum cBarge sessions.** The maximum number of active cBarge conference sessions is the same as the maximum number of Ad Hoc conference sessions allowed on your system. You can view this information on the Conference tab.
- **Maximum number of cBarge participants per session.** A cBarge conference supports the maximum number of participants that are configured for Ad Hoc conferencing on your UC500 platform. You can view this information on the Conference tab.
- If no Ad Hoc conference session is available or the maximum number of participants is reached, the cBarge request is rejected, and an error message is displayed on the initiating phone.
- When any party releases from the call, the call remains a conference call if at least three (3) participants remain on the line. If only two participants remain in the conference, they are reconnected as a point-to-point call, which releases the conference bridge resources.
- When the target party parks the call or joins the call with another call, the cBarge initiator and the other parties remain connected.

The Privacy feature works in conjunction with cBarge. This feature allows users with cBarge enabled for a shared extension to block other users who share the extension from seeing call information, resuming a call, or barging into a call on the shared extension. The phone must have an available line button in order to enable this feature.

When Privacy is configured for a phone with cBarge using CCA:

- A Privacy button is placed on the phone. If no line button is available, a message appears in the CCA Error bar.
- The phone user can press the Privacy button on their phone to toggle Privacy between On and Off.
- When Privacy is On, the Privacy button on the user's phone lights Amber.

### **cBarge and Privacy Usage and Examples**

**Usage.** Assume User A and User B both have extension 222 assigned to a button on their respective phones. Extension 222 is configured as a shared octal-line extension. The cBarge feature is enabled for extension 222 on both phones, and Privacy is disabled (Off) on both phones.

The **cBarge** softkey becomes available when User A presses the line button for Extension 222 to answer an incoming call on the shared line. While User A is on the call on Extension 222, User B can press the **cBarge** softkey on their phone to join the conversation with User A and the other party on Extension 222. This is accomplished internally by creating an Ad Hoc conference between User A, User B, and the other party on Extension 222.

To extend this example:

- If a third user, User C, also has the shared octal-line extension configured on their phone, they can also press the **cBarge** softkey on their phone to join the conference.
- If User A then presses the Privacy button on their phone to toggle Privacy On, the **cBarge** softkey is not available to the other users with Extension 222 on their phone and no other users can join the call.

cBarge and Privacy can be enabled or disabled on phones that share the same octal-line extension. When cBarge is Disabled, Privacy can still be enabled. Here are some examples.

**Example 1.** In a work environment where all employees are peers, all phones that share the same octal-line extension can have both cBarge and Privacy enabled.

Phones/Users	cBarge	Privacy	Result of the Configuration
All phones	Enabled	Enabled	Any user of the shared extension can barge into any call on that extension and/or set Privacy for calls on the shared extension.

**Example 2.** In a small call center environment where a supervisor and multiple employees share the same octal-line extension, cBarge and Privacy can be configured as shown below.

Phones/ Users	cBarge	Privacy	Result of the Configuration
<b>Supervisor phone</b>	Enabled	Disabled	The supervisor can barge into any of their employee's calls on the shared octal-line extension.  There is no need to enable Privacy on the Supervisor phone, since none of the employees can barge into a call on the shared extension.
<b>Employee phones</b>	Disabled	Disabled	Employees with this shared octal-line extension cannot barge into any calls or enable Privacy for calls on this extension.

**Example 3.** In an office where a manager has several supervisors who each monitor a small group of employees, you can configure cBarge and Privacy as shown below.

Phones/Users	cBarge	Privacy	Result of the Configuration
<b>Manager phone</b>	Enabled	Enabled	The Manager can barge into calls on the shared extension made by either supervisors or employees.  Only the manager can make their calls private on this extension.
<b>Supervisor phones</b>	Enabled	Disabled	The supervisor can barge into any of their employee's calls on the shared octal-line extension but cannot barge into a call on the shared extension when the Manager has Privacy On.
<b>Employee phones</b>	Disabled	Disabled	Employees with this shared octal-line extension cannot barge into any calls or enable Privacy for calls on the shared extension.

### Prerequisites for cBarge and Privacy

To configure Conference Barge and Privacy features, your system must meet the following requirements:

- UC500 Software Pack 7.0.2 or later is required to ensure that the required versions of Cisco IOS and CUE are installed (Cisco IOS 12.4(20)T2 or later and CUE 7.0 or later). For Cisco 7931 phones, UC500 Software Pack 8.0.4 is required.
- Multiparty conferencing must be enabled and Ad Hoc conference sessions and participants must be configured before you can configure cBarge and Privacy features. See [Conference](#), page 382.
- Shared octal-line extensions must be configured on phones before you can configure cBarge and Privacy features. See [Setting Up Shared Octal Line Extensions](#), page 390.

### Unsupported Phones

cBarge and Privacy features cannot be configured for single-button phones and phones that do not support shared octal-line directory numbers (DNs). Phones that do not support shared octal-line DN are listed below:

- Analog FXS phones
- ATAs
- Cisco Model 7935,7936,7937 and 39xx phones  
Model 7931 phones *are* supported.
- Cisco Model CP-521 IP Phones
- Cisco Model CP-52xG IP Phones
- Cisco Model 7902, 7905, 7906, 7910, 7911, 7912, 7920, and 7985 IP Phones
- All Cisco SPA500 Series Phones (Models SPA501G, SPA525G, SPA525G2, and SPA50x)
- All Cisco SPA300 Series IP Phones
- SCCP analog phones (VG224 type)

---

## Setting Up Shared Octal Line Extensions

For more information about octal lines, see [Octal Lines, page 344](#).

To configure a shared octal-line extension on a phone so that **cBarge** be enabled on a phone, follow these steps.

- 
- STEP 1** Follow the instructions in the section [Share Extension, page 333](#).
  - STEP 2** Make sure that the line type is set to **Octal Line** when configuring Line Options for the Shared line button on the phone.
  - STEP 3** Once you have created the Shared octal-line extension, add that Shared line to a button on each of the phones that will be configured with cBarge and Privacy enabled.  
  
For a list of phones that do not support this feature, see [Unsupported Phones, page 389](#).
  - STEP 4** Click **OK** to apply the changes and close the Users and Phones window.
- 

## Configuring Conference Barge and Privacy Features

After you have enabled multiparty conferencing and configured the required shared octal-line extensions on phones, follow these steps to configure cBarge and Privacy features for these extensions.

- 
- STEP 1** From the feature bar on the left, choose **Configure > Telephony > Voice Features > Conference Barge**.  
  
All phones on the system with shared octal-line extensions are listed. The cBarge and Privacy features are Disabled on these extensions by default.
  - STEP 2** For each phone, choose whether to enable cBarge and Privacy.  
  
cBarge and Privacy can be enabled or disabled on phones that share the same octal-line extension. For some usage examples, see [cBarge and Privacy Usage and Examples, page 386](#).  
  
To enable Privacy for a shared octal line, you must have an available line button. If there are no available line buttons on the phone, the error bar displays the message “Cannot enable Privacy on <FirstName LastName> (username) because no line buttons are available.”
-

---

**STEP 3** Click **OK** or **Apply**.

---

### Removing cBarge and Privacy for a User's Phone

To remove cBarge or Privacy from a phone, follow these steps.

---

**STEP 1** From the feature bar on the left, choose **Configure > Telephony > Voice Features > Conference Barge**.

**STEP 2** Locate a user in the list.

**STEP 3** To remove cBarge from the associated user's phone, choose **Disabled** from the pull-down list in the cBarge column.

**STEP 4** To remove Privacy from the associated user's phone, choose **Disabled** from the pull-down list in the Privacy column.

**STEP 5** Click **OK** or **Apply**.

---

## Music on Hold (MoH)

To configure Music on Hold settings, choose **Configure > Telephony > Voice Features > Music on Hold** from the feature bar.

### Overview

Music on Hold (MoH) provides music from a streaming external source or .wav file on the UC500 flash to a caller who was placed on hold by another caller.

### Procedures

To configure music-on-hold, follow these steps.

---

**STEP 1** In the **Audio File** field, choose **None** or choose a audio file.

**STEP 2** Choose whether to enable music on hold for internal calls and/or enable Music on Hold input from a music source connected to the external Music on Hold port on the UC500.

- When **Enable music on hold for internal calls** is checked, internal IP phone-to-IP phone calls placed on hold hear music. Otherwise, internal callers hear tone on hold.
- When **Enable external music on hold port** is checked, music on hold for internal calls is automatically enabled and cannot be disabled. If an audio file is selected and the external music-on-hold port is also enabled, the music input from the external port takes precedence. The selected audio file serves as a backup music source if the external source fails or is not available.
- MoH for a PSTN or SIP trunk is always enabled, even if MoH for internal calls is disabled. To disable MoH for PSTN or SIP trunk calls, uncheck all options and select None for the audio file.

**STEP 3** Click **Apply**.

---

To upload a custom Music on Hold audio file (.au file) to the UC500:

---

**STEP 1** Choose **Home > Topology** to open the Topology View.

**STEP 2** Drag and drop the audio file from your desktop onto the UC500 icon in the topology view.

The audio file must have an .au extension.

Once you have uploaded the file, it becomes available on the Audio File selection list for Music on Hold.

For specifications and instructions on how to create a custom audio file for Music on Hold, see the *Cisco Unified Communications Manager Express System Administrator Guide*, available on Cisco.com.

---



# Call Handling

These topics are covered:

- **Schedules**
- **Auto Attendant**
- **Basic Automated Call Distribution (ACD)**
- **Night Service**
- **Live Record**
- **T.37 Fax to Mail**

## Schedules

To configure schedules, choose **Configure > Telephony > Call Handling > Schedules**.

Business hours, holidays, and night service schedules are managed from these tabs in the Schedules window:

- **Business Hours**
- **Holidays**
- **Night Service Schedule**

### Business Hours

The Business Hours schedule defines open and closed hours. This enables the **Auto Attendant** to be configured to present different prompts and perform different actions for open and closed hours. You can define up to four different business schedules.

If you are using multiple auto attendants, you can set up a separate schedule for each one. You can configure open and closed hours for each day of the week, in half-hour increments.

To enable and define a schedule:

- 
- STEP 1** Select a schedule from the list on the left side of the tab.
- STEP 2** Click **Enable Business Schedule** to enable and open the selected schedule for editing.
- STEP 3** Edit the name of the schedule to provide a more descriptive name. The default name is systemschedule.
- STEP 4** Use the pull-down menus at the top of the window to specify open and closed hours for the days of the week, then click **Update Table** to refresh the display.
- You can also click checkboxes inside the table to set business hours.
- Timeslots marked with a check indicate hours that the business is open.
- STEP 5** Click **Apply** or **OK**.
- 

### Holidays

Up to 26 holidays can be defined per year, for the current year and for the next year. However, if Night Service is also configured, Night Service is activated only for the first 15 holidays entered (a warning message is displayed if Night Service is enabled and you add more than 15 holidays). On scheduled holidays, the **Auto Attendant** activates its Closed Hours prompts and actions. **Night Service** is activated, if it is configured for the site.

You can also modify or delete existing holidays or copy all holidays from the current year to the next year. When copying holidays from the current year to the next year, if the same date appears in both years, the current year entry is used.

**NOTE** You cannot modify the year for an existing holiday. Delete and re-add the holiday if you need to change the year.

To add a holiday:

- 
- STEP 1** In the Schedules window, choose either the current year or next year.
- STEP 2** Click **Add** to open the Add Holiday window (see [Add Holiday, page 395](#)).

---

**STEP 3** When finished adding holidays, click **OK**.

---

### Add Holiday

This window appears when you click **Add Holiday** from the Schedules window.

To add a holiday, follow these steps.

---

**STEP 1** Click the calendar icon and choose a date from the selected year.

**STEP 2** Use the forward (>) and back (<) arrows to go to different months in the calendar.

**STEP 3** Enter a description for the holiday. The description can contain up to 64 characters.

**STEP 4** Click **OK**.

---

### Night Service Schedule

Specify the hours that Night Service is enabled for each day of the week.

Once you have configured a night service schedule, go to **Configure > Telephony > Call Handling > Night Service** to enable and configure this feature.

During Night Service hours:

- Night service is enabled for the specified phones and extensions.
- Calls to extensions with call forward to another number after hours are automatically forwarded to that number.

On holidays, Night Service is activated if it is configured for the site.

To configure Night Service hours, follow these steps.

---

**STEP 1** Select a day of the week from the pull-down menu or click the row corresponding to a day of the week in the Night Service Schedule summary display.

**STEP 2** Use the **from** and **to** pull-down menus to set the hours for the selected day. Click **Delete** to clear the hours for that day.

**STEP 3** Click **Add** to add hours. Skip this step if you are deleting hours.

**STEP 4** Continue selecting days of the week and setting Night Service hours.

---

Use the **Copy selected row to** option to copy settings from one day to a different day of the week, weekend days, or weekdays.

Example: if you want Night Service to be active from 4:00 pm to 9:00 am Monday through Friday and 24 hours on Saturday and Sunday, set up the From Hours and To Hours as shown below:

Day	From Hours (HH:MM)	To Hours (HH:MM)
Monday	17:00	8:00
Tuesday	17:00	8:00
Wednesday	17:00	8:00
Thursday	17:00	8:00
Friday	17:00	8:00
Saturday	9:00	8:00
Sunday	9:00	8:00

**STEP 5** Click **Apply** or **OK**.

For more information, see these topics:

- [Auto Attendant, page 396](#)
- [Night Service, page 411](#)

## Auto Attendant

To configure an Auto Attendant and manage Auto Attendant prompts and scripts, choose **Configure > Telephony > Call Handling > Auto Attendant**.

These topics are covered:

- [Prerequisites](#)
- [Auto Attendant Configuration](#)
- [Prompt Management](#)

- [Script Management](#)

## Prerequisites

Before setting up Auto Attendant configuration and prompts, these telephony features should already be set up:

**NOTE** Telnet must be enabled in order to configure Auto Attendant features.

- Phone extensions and associated voicemail accounts
- Dial plan and associated voice features
- Schedules for business hours of operation and holidays
- Basic ACD service parameters, if used
- Voicemail transfer prefix, if **Direct Transfer to Voicemail** is used as an Auto Attendant option

## Auto Attendant Configuration

The Auto Attendant tab initially displays options for enabling or disabling the Auto Attendant and choosing whether to configure a standard Auto Attendant with one level of menus (the default) or a multi-level Auto Attendant with submenus.

For instructions on how to configure the Auto Attendant, see these sections:

- [Auto Attendant Modes, page 397](#)
- [Configuring a Standard Auto Attendant, page 398](#)
- [Configuring a Multi-Level Auto Attendant, page 400](#)

### Auto Attendant Modes

Three Auto Attendant modes are available:

- **Off.** When the Auto Attendant mode is set to **Off**, the factory default settings are used, and the AA Script is set to aa.aef.

If you choose to disable the Auto Attendant by setting the mode to **Off**, the dial plan mapping between the AA PSTN number and AA internal extensions are deleted. Voice feature settings that reference the Auto Attendant, such as the main number, hunt groups, and call blast groups, may need to be modified.

- **Standard.** The **Standard** Auto Attendant mode enables you to configure up to three (3) Auto Attendants, each with a single level of menus. See [Configuring a Standard Auto Attendant, page 398](#).
- **Multi-Level.** The **Multi-Level** Auto Attendant mode enables you to configure the AA so that it presents a main menu with up to three (3) submenus to callers. See [Configuring a Multi-Level Auto Attendant, page 400](#).

When you change the Auto Attendant mode, the existing Auto Attendant configuration is not retained. You must reconfigure all of the parameters if you change modes.

### Configuring a Standard Auto Attendant

To configure a standard Auto Attendant, follow these steps.

- 
- STEP 1** In the **Mode** field, make sure that **Standard** is selected.
- STEP 2** In the **Number of Auto Attendants**, choose the number of Auto Attendants to configure.
- STEP 3** In the **AA Extension** field, enter the extension number to be accessed for general company auto attendant functions.

This is usually the main telephone extension number for the office. When a caller dials this extension, the Auto Attendant script runs. The AA Extension must be unique across the system. The default AA Extension is 398.

- STEP 4** In the **AA PSTN Number** field, enter the PSTN number to be accessed for general company Auto Attendant functions.

The PSTN number can begin with a “+” character.

- STEP 5** In the **AA Script** field, choose the AA script that is to run when the Auto Attendant is triggered.

These CCA and system scripts are listed.

- **aa\_sbcs\_v03.aef** is the default script. This is a more advanced script that supports multi-level AA menus and enables configuration of separate key actions and prompts for business hours and closed hours, based on pre-defined Business and Holiday schedules. It also supports options for **Dial by Number** and **Allow External Transfer**, as well as fallback to a configurable number (**No Option Transfer To**) if the caller does take any action after the main menu prompt plays three times.
- **aa\_sbcs\_v02.aef** provides the same functions as **aa\_sbcs\_v03.aef** except that it does not support the **No Option Transfer To** field.

- **aa.aef** and **aasimple.aef** are default system scripts that are deployed as part of Cisco Unity Express (CUE). When either of these scripts is selected, CCA allows only the base parameters to be configured (AA extension, AA PSTN number, and AA script).
- **aa\_transfer2.aef** is an updated version of the **aa\_transfer.aef** script that supports two additional key options (# and \*) and the **Play Prompt** action.

You can upload custom user-defined scripts. However, for user-defined scripts, CCA only configures the AA extension and the AA PSTN number. See [Script Management, page 403](#). These configuration steps apply only when the **aa\_sbcs\_v02.aef** or **aa\_sbcs\_v03.aef** AA script is selected.

Migration between AA Scripts is not supported. If you change the AA Script, any existing configuration is removed.

- STEP 6** In the **Business Hour Schedule** field, choose the business schedule to use for this Auto Attendant.
- STEP 7** Choose whether to enable **Dial by Number Anytime** and **Allow External Transfer**. When **Dial by Number Anytime** is enabled, callers can enter the callee's number at any time and the call will be directed to that number.
- STEP 8** If you are using the **aa\_sbcs\_v03.aef** script, you can optionally enter an number in the **No Option Transfer To** field. This number can be an internal extension or an external PSTN number.
- If you specify an external PSTN number, enter the number exactly as you would dial it on the phone, including any access codes.
  - If you specify an internal extension, make sure that you have entered the extension correctly. CCA does not check to see whether the extension is valid on your system.

If you specify a number for **No Option Transfer To** and the caller does not press a key for which an action is defined, the main menu prompt is repeated two more times, then the call is redirected to that number.

If you do not specify number in this field and the caller does not press a key for which an action has been defined, the main menu prompt is repeated two more times, then the call is ended.

**STEP 9** Configure prompts and key actions for both **Business Hours** and **Closed Hours**.

- a. In the **Menu Prompt** field, choose the .wav file for the prompt to play when the Auto Attendant is triggered.
- b. *(Optional)* Click **Record** to use the CCA record and playback feature to record menu prompts.
- c. Define key actions. For each key action you wish to define:
  - Click in the **Mode** column to choose the type of action.
  - Click in the **Parameters** column to set input parameters, if needed.

For example, to have the AA direct the call to a hunt group when the user presses 4, select **Call Hunt Group** in the **Mode** column, then choose a hunt group from the list of available hunt groups displayed in the **Parameter** column.

Available actions include **Call Blast Group**, **Call Hunt Group**, **Call Voicemail**, **Transfer to Voicemail**, **Transfer to Basic ACD**, **Call Extension**, **Play Prompt**, **Dial-by-Name**, **Dial-by-Number**, **Call Other Number**, and **None**.

If an external number is specified for **Call Other Number**, make sure that the number is entered exactly you would dial it, including access codes or long distance codes, if required.

**STEP 10** Click **Apply** or **OK**.

---

**Configuring a Multi-Level Auto Attendant**

The **Multi-Level** Auto Attendant mode enables you to configure the AA to present a main menu with up to three (3) submenus to callers.

If you choose to have multiple Auto Attendants (up to 3 can be defined), additional tabs are displayed for configuring each Auto Attendant, and the same configuration steps apply.

Configuring a multi-level AA with submenus is similar to configuring a **Standard** Auto Attendant, with these exceptions:

- For the Main menu configuration, the default Auto Attendant script is always used (**aa\_sbcs\_v03.aef**), and the script selection option is not displayed.
- For submenus, the **aa\_transfer2.aef** script is always used, and the script selection option is not displayed.



- One additional key action, **Call Menu**, is provided so that you can assign keys for navigating between the main menu and submenus.

For information about configuring the rest of the settings, see [Configuring a Standard Auto Attendant, page 398](#).

## Prompt Management

From the Prompt management tab, you can:

- Create prompts using one of these methods:
  - **Record prompts using the CCA sound recorder.** This method allows you to record and play back prompts from within CCA by using the integrated CCA sound recorder. See [Record Prompts Using Sound Recorder, page 402](#).
  - **Upload previously recorded custom prompts from a PC.** You can record and play back .wav files on your PC and upload them to CUE. The .wav file must be recorded in G.711 u-law, 8-kHz, 8-bit mono format (Windows) or G.711 u-law, 44100-Hz, 8-bit mono format (Mac). The prompt cannot be longer than 60 seconds. See [Upload Prompts, page 402](#).
  - **Use the CUE Greeting Management System to record prompts from a phone.** To use this method, you configure an extension for AA prompt management on CUE and assign prompt management privileges to users. The ability to record prompts from a phone eliminates the need for a PC or sound editing software to manage prompts.

The prompt management extension is the extension that users with prompt management privileges dial to record or delete prompts. When a user with prompt management privileges dials the prompt management extension, they must enter their extension number and voice mail PIN to log in. See [Enable Prompt Management via Phone and Assign Prompt Management Privileges to Users, page 402](#).

- Upload prompts. See [Upload Prompts, page 402](#).
- Change the prompt file name.

Filenames for user-created prompts recorded from phones or through the built-in sound recorder are initially named User\_Prompt\_<time\_stamp>.wav.

To rename a prompt so that you can easily identify it when assigning it a key, click on the **PromptName** in the list of Available Prompts, edit the name, and then click **OK**.

- Delete prompts.

To delete a prompt, click on the **PromptName** in the list of Available Prompts, click **Delete**, then click **OK**.

### Record Prompts Using Sound Recorder

To record Auto Attendant or Basic ACD prompts using the integrated sound recorder, follow these steps.

- 
- STEP 1** Select the Prompt Management tab in the Auto Attendant window.
- STEP 2** In the **Create Prompts, Record Using Sound Recorder** section of the Prompt Management tab, click **Open**.
- STEP 3** Use the integrated sound recorder to record and save the prompt. See [Sound Recorder, page 403](#).
- 

### Upload Prompts

To upload a previously recorded prompt file from your PC:

- 
- STEP 1** Select the Prompt Management tab in the Auto Attendant window.
- STEP 2** In the **Available Prompts** section of the **Prompt Management** window, click **Add**.
- STEP 3** Click **Browse** to locate the prompt file on your PC.
- STEP 4** *Optional:* Use the **Play Prompt** controls to listen to the prompt.
- STEP 5** Click **OK**.
- 

### Enable Prompt Management via Phone and Assign Prompt Management Privileges to Users

To enable prompt recording from a phone on the system and assign prompt management privileges to users, follow these steps.

- 
- STEP 1** Select the Prompt Management tab in the Auto Attendant window.
  - STEP 2** In the **Prompt Recording Extension** field, enter the extension to use for recording prompts.
  - STEP 3** In the **Prompt Administrators** field, click **Users**.
  - STEP 4** In the **Assign Prompt Privileges to Users** dialog, click the **Add** and **Remove** arrow buttons or use **SelectAll** to manage the list of selected users.
  - STEP 5** Click **OK**.
- 

### Sound Recorder

This window appears when you click **Record** from the Prompt Management tab in the Auto Attendant or click **Record** from the Create/Edit Basic ACD Parameters window.

To record Auto Attendant or Basic ACD prompts using the integrated sound recorder, follow these steps.

- 
- STEP 1** Click **Record** and begin recording your message. You can pause, play back, and stop the recording.
  - STEP 2** When you are satisfied with your recording, click **Browse** to navigate to where you want to store the .wav file on your PC and enter an appropriate file name for the prompt.
  - STEP 3** Click **OK**. When you click **OK**, CCA closes the sound recorder and saves the new prompt file to your PC.
- 

### Script Management

You can upload, rename, and delete custom Auto Attendant scripts created using the CUE AA script editor.

Up to two (2) custom user-defined AA scripts can be used. A maximum of 12 scripts are allowed; however, 10 of these script slots are reserved for CCA and default CUE system scripts, which cannot be deleted.

For custom, user-defined scripts, CCA only configures the AA extension and the AA PSTN number. You must use the CUE GUI to configure all other script parameters.

CCA-supported AA scripts (such as `aa_transfer2.aef`, `aa_sbcs_v02.aef`, and `aa_sbcs_v03.aef`) and CUE system default AA scripts (such as `aa.aef` and `aasimple.aef`) cannot be deleted, modified, renamed, or overwritten.

For information on how to create CUE AA scripts, see the *Cisco Unity Express Guide to Writing and Editing Scripts*, available on Cisco.com.

### Procedures

To upload a custom AA script, follow these steps.

- 
- STEP 1** From the Script Management tab in the Auto Attendant window, click **Add**.
  - STEP 2** Click **Browse** to locate the file on your PC.
  - STEP 3** Click **OK**.
- 

To delete a custom AA Script, follow these steps.

- 
- STEP 1** From the Script Management tab in the Auto Attendant window, click on a script in the Available Prompts list to select it.
  - STEP 2** Click **Delete**.
- 

You cannot delete a script that is currently being used by the Auto Attendant.

---

## Basic Automated Call Distribution (ACD)

To configure Basic ACD, choose **Configure > Telephony > Call Handling > Basic ACD** on the feature bar.

This section covers these topics:

- **Overview**
- **Before You Begin**
- **Create/Edit Basic ACD Parameters**

- **Configure Basic ACD Service**
- **Hunt Group Report Parameters**

## Overview

Basic ACD (BACD) provides automatic answering and distribution of incoming calls through interactive menus and hunt groups.

A Basic ACD application consists of one call queue service and up to 10 Basic ACD services. For each Basic ACD service, you configure a pilot number for the service, hunt group parameters, prompts, destination for unanswered calls, timeout, number of retries, and other settings.

The Basic ACD call flow implemented in Configuration Assistant is limited to *drop-through mode*, in which the Auto Attendant serves as the top-level entry point and control is transferred to Basic ACD for second-level menu actions.

When an Auto Attendant is configured for drop-through mode, the Auto Attendant sends incoming calls directly to a call queue without providing menu choices to callers. Once in the queue, a caller hears ringback if an agent is available or Music on Hold (MoH) if all agents are busy. If a prompt for drop-through mode is configured, the caller hears the prompt before being sent to the queue as described. The drop-through prompt is simply a greeting to callers; it might say “Thank you for calling XYZ, Inc. An agent will be with you shortly.” Note that customers cannot make interactive choices in drop-through mode; calls are simply answered and routed to a call queue.

The BACD capabilities of the UC500 Series platform are listed below:

- Up to 10 BACD hunt groups (call queues)
- Up to 30 calls allowed in each queue
- Up to 20 agents can be members of a BACD hunt group

CCA Release 2.5 and later adds the **HLog** softkey on BACD agent phones. Agents can now log in or out of a BACD hunt group using the **HLog** softkey. The **HLog** softkey is displayed on agent phones when an incoming call to the BACD hunt group is received. Users can also access this softkey from the main phone screen by pressing the **more** softkey. The **HLog** softkey replaces the use of DnD (Do Not Disturb). DnD is less flexible, since it makes the subscriber generally unavailable for all calls, not just BACD hunt group calls.

See [Create/Edit Basic ACD Parameters, page 407](#) for an explanation of the summary parameters displayed in the Basic ACD window for configured BACD services.

## Before You Begin

Before configuring Basic ACD:

- Define the call flow and options to present to callers.
- Determine what prompts are needed and which ones will need to be customized.
- Make sure that phones and users are configured.
- When you configure Basic ACD, Configuration Assistant automatically creates hunt groups to handle Basic ACD forwarding. Parameters for these hunt groups are configured from the Create/Edit Basic ACD Parameters window.
- Configure basic Auto Attendant settings. After you configure the Basic ACD service, the **Transfer to Basic ACD** option can be selected as an action, which allows you to transfer control from the Auto Attendant to a basic ACD service.

## Configure Basic ACD Service

To configure a Basic ACD service, follow these steps.

- 
- STEP 1** In the **Basic Parameters Summary** section of the Basic ACD window, click **Create** or **Modify**. The Create/Edit Basic ACD Parameters window opens.
- STEP 2** Configure service parameters, hunt groups, and prompts in the Create/Edit Basic ACD Parameters window. See [Create/Edit Basic ACD Parameters, page 407](#) for information about these settings.
- STEP 3** Click **OK** or **Apply** and close the Basic ACD window.

Once you have created the service and its local hunt group, the **Transfer to Basic ACD** action is now available in the Auto Attendant window. Select this action for a Key to have the Auto Attendant transfer control to the Basic ACD service when the caller presses that key on their phone.

To specify a Basic ACD service as the action for a key press using the Auto Attendant, follow these steps.

This procedure assumes that you have already configured basic Auto Attendant greetings, schedules, and prompts.

- 
- STEP 1** Navigate to **Configure > Telephony > Call Handling > Auto Attendant**.
  - STEP 2** Select the Auto Attendant tab.
  - STEP 3** Locate the key that callers will press to be automatically transferred to the Basic ACD service you just configured and choose **Transfer to Basic ACD** for the **Mode**.

The Parameter field automatically updates to show the pilot extension for the Basic ACD service. For example: **701 (aaService0)**.

---

## Create/Edit Basic ACD Parameters

The Create/Edit Basic ACD Parameters window appears when you click **Create** or **Modify** in the Basic ACD window (**Configure > Telephony > Call Handling > Basic ACD**).

### Service Parameters

Configure Service Parameters as described below for each Basic ACD service. Up to 10 Basic ACD services can be configured.

Setting	Description
<b>Pilot Number</b>	Extension for this Basic ACD service. This is the number that is dialed by the Auto Attendant when the Transfer to Basic ACD action is executed.
<b>No Answer Forward to</b>	Destination for calls unanswered by the B-ACD hunt group, either because all agents are logged out or busy, or the maximum call retry limit is exceeded. Unanswered calls can be forwarded to the Auto Attendant, Hunt Group, Blast Group, Voice Mail, an internal extension, or Other Number (external PSTN number).

Setting	Description
<b>Play Busy Prompt in x Seconds</b>	Number of seconds to wait before playing the Basic ACD busy prompt. This is the time delay between when the caller joins the B-ACD queue and when the second greeting is played or replayed. The same time interval is used between repeats of the second greeting. Valid values range from 30 to 120 seconds. The default value is 60 seconds. The default busy prompt file is en_bacd_allagentsbusy.au.
<b>No Answer Forward To in x Seconds</b>	Maximum amount of time for call retry before the call is forwarded to the destination specified by <b>No answer forward to</b> . This is the maximum amount of time that the call can stay in the queue. Valid values range from 60 to 3600 seconds. The default value is 600 seconds.
<b>Retry Number in x Seconds</b>	Number of seconds to wait before re-sending the call to the local hunt group for this B-ACD service.
<b>Transfer to B-ACD Prompt</b>	<i>Optional.</i> This is the filename for the Transfer to B-ACD Prompt.
<b>Welcome Prompt</b>	<i>Optional.</i> This is the filename for the B-ACD Welcome Prompt.
<b>Max Retry Before Call Drops</b>	Number of times to retry the destination specified for <b>No answer forward to</b> before the call is dropped. When the call is dropped, the Basic ACD disconnect prompt is played. Valid values range from 1 to 3. The default value is 1.



## Hunt Group Parameters

Configure settings for Hunt Group Parameters as described below for each configured Basic ACD service. The Basic ACD hunt group that is created is local to the Basic ACD service.

Setting	Description
<b>Hunt Type</b>	<p>Defines the order in which calls are distributed to members of the Basic ACD hunt group. Choose one of these types:</p> <ul style="list-style-type: none"> <li>▪ <b>sequential.</b> Calls are routed to Basic ACD hunt group members in the order they are listed in the Members dialog.</li> <li>▪ <b>peer.</b> Calls are routed to Basic ACD hunt group members in round-robin order.</li> <li>▪ <b>longest-idle.</b> Calls are routed to the member of the Basic ACD hunt group with the longest idle time.</li> </ul>
<b>Members</b>	<p>Click <b>Members</b> to open a dialog for selecting phones and their associated users as members of this Basic ACD hunt group. See <a href="#">Members of Hunt Group, page 410</a>.</p>
<b>Hunt Timeout</b>	<p>Number of seconds before a call that is unanswered by a member of the hunt group is directed to the next member, as specified by the Hunt Type. The default is 8 seconds.</p>
<b>Enable Auto Logout</b>	<p>When this option is checked, autologout is enabled. When the <b>Attempts Before Logout</b> value is exceeded, the agent phone is automatically logged out of the Basic ACD hunt group.</p>
<b>All Agents Logged Out Display Message</b>	<p>Message to display when all agents (hunt group members) are logged out. The default is All Agents Logged Out. The message can contain up to 39 characters.</p>
<b>Attempts Before Logout</b>	<p>Maximum number of unanswered calls to the B-ACD hunt group member (from 1 to 20) before autologout. The default value is 3.</p>

## Prompts

To manage Basic ACD prompts, configure settings as described below. When you are finished making changes, click **OK** or **Apply**.

Setting	Description
<b>Welcome Prompt</b>	Choose from one of the default Basic ACD prompts listed or click <b>Record</b> to record a custom prompt using the built-in sound recorder.
<b>Transfer to Basic ACD Prompt</b>	Choose from one of the default Basic ACD prompts listed or click <b>Record</b> to record a custom prompt using the built-in sound recorder.

## Members of Hunt Group

This window appears when you click the **Members** button in the Create/Edit Basic ACD Parameters window.

To create or edit the list of hunt group members and their associated phones, follow these steps.

- 
- STEP 1** Click on a user in the Available or Selected list. Use the CTRL-click and SHIFT-click keyboard shortcuts to select multiple users in either list.
  - STEP 2** Use the **Add**, **Remove**, and **Select All** buttons to move selected users between the Available and Selected lists.
  - STEP 3** Use the **Up** and **Down** arrow buttons to order the members of the hunt group.
  - STEP 4** Click **OK** to apply your changes.
- 

## Hunt Group Report Parameters

The Basic ACD feature uses the CME B-ACD report generator to create simple CSV-format report files that can be imported into a spreadsheet program.

To enable Basic ACD reporting and configure hunt group report parameters, complete the fields in the Hunt Group Report Parameters section of the window as described below.

When you are done configuring Basic ACD hunt group report settings, click **OK** or **Apply**.

Setting	Description
<b>Enable CME Report</b>	When checked, Basic ACD hunt group report generation is enabled. Basic ACD reporting is disabled by default.
<b>CME Report Location</b>	Location of the TFTP or FTP server and directory for Basic ACD reports. The format is <b>tftp://&lt;ServerIPAddress&gt;/&lt;directory&gt;/&lt;filename&gt;</b> or <b>ftp://&lt;ServerIPAddress&gt;/&lt;directory&gt;/&lt;filename&gt;</b> .  For example: <b>tftp://192.168.10.1/bacdrpts/mybacd</b>
<b>Number of Reports</b>	The number of simple CSV-format report files to be created. Valid values range from 1 to 200.
<b>Frequency of Reports (hrs)</b>	Frequency of report generation, in hours. Valid values range from 1 to 84.
<b>Manually Upload Reports</b>	If CME reporting is enabled, click <i>Manually Upload Reports</i> to immediately trigger sending of report data to the specified report location on the TFTP server.  This option is unavailable when CME reporting is disabled.

## Night Service

To configure Night Service, choose **Configure > Telephony > Call Handling > Night Service** from the feature bar.

Before you can enable Night Service, you must set up a night service schedule from the Night Service Schedule tab in the Schedules window (**Configure > Telephony > Call Handling > Schedules**). See [Night Service Schedule, page 395](#).

### Overview

Up to four extensions can be configured for night service. Each extension can be configured with a Call Forward number or a Night Service Bell.

When a call forward number is configured for a night service extension, incoming calls to that extension during night service hours are forwarded to that number.

The night service bell allows you to provide coverage for unstaffed extensions for night-service hours. During night-service hours, extensions configured for night-service bell receive notification of incoming calls with a special “burst” ring. Phone users at the night-service phones can then use the call-pickup feature to answer incoming calls.

To configure night-service phones, at least one of the extensions must be configured with a night service bell.

A user can enter a night-service code to manually toggle night-service treatment off and on from any phone with a night service extension. The night service toggle code turns night service on or off for all phones with night service.

The following limitations apply to night service:

- Analog phones do not receive night service notifications. However, the extensions for the analog phones that are configured with a User Phone role can be configured to be monitored during night service.
- IP phones that do not have softkeys can use feature access codes to pick up calls to the night service extension.

### Procedures

To configure a night service extension with a call forward number:

- 
- STEP 1** In the **Extn #** field, choose an available extension from the drop-down list.
  - STEP 2** In the **Answer Type** field, choose **call forward night service**.
  - STEP 3** Enter a number in the **Forward to Number** field.

Inbound calls to this extension during night service hours are forwarded to this number.

This number can be an external PSTN number or an extension number. When entering an external PSTN number, enter the number exactly as you would dial it, including the access code.

- STEP 4** Repeat the steps 1 to 3 to configure night service with a call forward number for more extensions.
  - STEP 5** Click **OK** or **Apply**.
-

---

To configure Night Service with Night Service Bell, follow these steps.

- 
- STEP 1** In the **Extn #** field, choose an available extension from the drop-down list.
  - STEP 2** In the **Answer Type** field, choose **night service bell**.
  - STEP 3** Click the **Night Service Phones** button to launch a window for selecting phones.
  - STEP 4** Select the phones from the available phones list.
  - STEP 5** Click **Add**.
  - STEP 6** Click **OK** or **Apply**.
- 

To configure a night service code, follow these steps.

- 
- STEP 1** In the **Night Service Code** field, enter the night service toggle code.  
  
You can enter up to 15 digits. CCA automatically prefixes the code with an asterisk (\*).  
  
When choosing a code for toggling Night Service, keep in mind that a default set of feature activation codes (used primarily for analog lines) are sent to the UC500 by CCA. To avoid overlap with these feature activation codes, the Night Service toggle code should begin with \*2, \*7, \*8, or \*9.
  - STEP 2** Click **OK** or **Apply**.
- 

To remove a night service extension, set the **Extn#** field to **None** and apply the change. You can also select a different extension and modify any of the other settings.

To modify the list of night service phones, click **Night Service Phones**, use the **Add**, **Remove**, and **Select All** buttons to update the Selected Phones list, then apply your changes.

For more information, see these topics:

- [Night Service Phones, page 414](#)
- [Night Service Schedule, page 395](#)

## Night Service Phones

This window appears when you click **Night Service Phones** in the Night Service window.

Click on phones from the **Available** list and use the **Add**, **Remove**, and **Select All** arrow buttons to move phones between the Available and Selected Phones lists.

Selected phones are configured as night service phones and will receive notification of incoming calls when night service is active. Phone users at the night-service phones can then press the **GPickUp** button on their phone to answer incoming calls.

When you are finished choosing phones, click **OK**.

For more information, see these topics:

- [Night Service, page 411](#)
- [Night Service Schedule, page 395](#)

## Live Record

This window appears when you choose **Configure > Telephony > Call Handling > Live Record** from the feature bar.

### Overview

Live Record enables users to record live conversations and store the recording as a message in their mailbox. They can then play it or forward it to another voice mailbox. The default setting for this application is disabled.

Phone users can start a Live Record session by pressing the **LiveRcd** softkey on their IP phone during a call. The system sets up a conference call between the Live Record pilot number you configure here and the party to be recorded.

Periodic beep tones are played to indicate that the call is being recorded. You can choose to enable or disable these tones and set the tone duration and interval.

The following notes apply to Live Record:

- External callers cannot use this feature because it uses the extension number assigned to the caller.
- Live Record messages do not trigger a message notification when delivered to a voice mailbox.

- The size of Live Record messages is limited only by the amount of space remaining in the subscriber's voice mailbox.

### Procedures

To enable and configure Live Record, follow these steps.

---

#### STEP 1 Configure **Live Record Settings**:

- a. Check the **Enable Live Record** option to enable this feature.
- b. In the Pilot Number field, enter the Live Record pilot extension number.

This extension is used to forward all incoming calls to the voice mail system pilot number. All calls sent to the voice mail pilot number from this number will bypass the voice mail greeting. If the caller has a voice mailbox, recording starts immediately.

#### STEP 2 Configure **Live Record Beep Settings**:

- a. The **Beep Duration** setting specifies the number of milliseconds that the beep tone will play. The beep duration can range from 50 to 1000 milliseconds. The default is 250 milliseconds.
- b. The **Beep Interval** specifies the number of seconds between the end of one beep and the start of the next beep. The beep interval can range from 1 to 30 seconds. The default beep interval is 15 seconds.

#### STEP 3 Click **OK** or **Apply**.

---

## T.37 Fax to Mail

To configure T.37 Fax to Mail, choose **Configure > Telephony > Call Handling > T.37 Fax to Mail** from the feature bar.

To learn more about T.37 Fax to Email features and configuration settings, see the following topics:

- [Overview](#)
- [Limitations](#)
- [Prerequisites for Configuring T.37 Fax](#)
- [Enabling T.37 Fax to Mail and Configuring Services](#)
- [Configuring Mailboxes for Incoming Faxes](#)

### Overview

T.37 is an ITU standard for sending fax messages using email. The CCA T.37 Fax to Mail feature allows the UC500 to act as a fax gateway for communicating with regular fax machines, converting faxes to emails, or converting emails to faxes. Within Cisco, this feature is also referred to as T.37 Store and Forward Fax.

The CCA T.37 Fax to Mail feature allows you to configure the UC500 and the voice mail system to provide the following features:

- **Incoming fax services**, using the On Ramp application.

Using CCA, you configure the voice mailboxes that will receive incoming faxes. The stored faxes can be forwarded as email attachments or sent to a fax printer. Fax messages are converted to image files in TIFF format. You can configure the mailboxes for fax-only service (all incoming calls are assumed to be fax calls) or for voice and fax service (incoming calls can be either voice calls or faxes).

CCA configures voice mailboxes for users, groups, and floating extensions (extension not associated with a phone or group). All voice mailboxes, including those associated with floating extensions, can receive and store fax mail, as long as that they are associated with an incoming phone number on a PSTN trunk.



- **Voice and fax detection**, using the Voice and Fax Detection Application.

Voice and fax detection provides the ability to detect whether an incoming call is voice or fax. This enables you to use a single incoming number for both voice and fax calls.

- **Fax printing**, using the Off Ramp application. This enables phone users to use the Telephony User Interface (TUI) to forward faxes stored in voice mail to a local fax machine for printing.
- **Receive faxes as email messages**. Using CCA, you can integrate T.37 Fax to Mail services with voice mail notification or IMAP services so that users can be notified of incoming faxes via phone or email, with the option to include the fax as an email attachment.
- **Record custom prompts or use default system prompts for incoming calls to lines configured to receive both fax and voice calls**. You can use the default prompts for incoming calls to lines with voice and fax detection or you can configure custom prompts. Default prompts are provided in US/English, Spanish, and Chinese.

CCA bundles the Interactive Voice Response (IVR) applications used for fax services, fax detection and fax printing. These applications are implemented as Tool Command Language (TCL) scripts and are uploaded to the UC500 flash when you apply the T.37 Fax to Mail configuration. The default prompts presented to users for incoming calls to lines configured with voice and fax detection are uploaded to the flash when you apply the configuration.

The application TCL scripts and default system prompts are located in the `flash:applications/faxmail` directory on the UC500 flash. Your custom prompts are placed in the `flash:applications/faxmail/custom` directory on the flash.

## Limitations

The following limitations apply to T.37 Fax to Mail configuration using CCA:

- Only mailboxes associated with incoming phone numbers on PSTN trunks can be configured to receive incoming faxes. SIP trunks are not supported.
- Voice and Fax Detection does not work with all fax machines or all modes of operation. Tones may not be detected correctly for fax machines operating in manual mode.
- Concurrent use of T.37 Fax Detection application and SNR is not supported.

- Phones that do not have a Telephony User Interface (TUI), cannot be used to forward faxes to a local fax machine for printing.

## Prerequisites for Configuring T.37 Fax

Before you enable and configure T.37 fax, the following configuration must be set up:

- Configure users, extensions, and voice mailboxes on the system.

To do this, go to **Configure > Telephony > Users and Extensions > Users and Phones** and select the User Extensions or Floating Extensions tab. Note that voice mailboxes for Hunt Groups and Call Blast Groups are created when No Answer Forward To option is set to Voicemail in the Phone Groups window (**Configure > Telephony > Phone Groups**).

- Only voice mailboxes associated with incoming phone numbers on PSTN trunks can be configured to receive incoming faxes. You must create an incoming dial plan for each extension with a voice mailbox that will be configured to receive incoming faxes.

To do this, go to **Configure > Telephony > Dial Plan > Incoming**. When selecting a Destination Type for Incoming FXO Calls or Direct Dial to Auto Attendant, Groups, or Operator, choose OPERATOR or HUNT\_GROUP as the Destination Type.

- If you want to enable Fax Printing, you must have a local fax machine connected to an FXS port on the UC500 and the FXS port must be assigned a FAX role. To do this, go to **Configure > Telephony > Ports and Trunks > FXS Ports**.
- To integrate T.37 Fax to Mail with voice mail notifications so that users can receive email notification of incoming faxes with the fax as an attachment, go to **Configure > Telephony > Users and Phones > Voicemail**, and configure notifications for the mailboxes that are set to receive incoming faxes.

For instructions on how to do this, see [Notifications, page 353](#).

**NOTE:** In order to receive email or phone notification of incoming faxes the Notification Level should be set to All Voicemail.

- You can also enable Unified Messaging in CCA to integrate T.37 Fax to Mail with IMAP. To enable Unified Messaging, go to **Applications > Smart**

**Applications > Smart Applications Manager.** See **Unified Messaging (IMAP), page 479.**

## Enabling T.37 Fax to Mail and Configuring Services

On the Services tab, you can:

- Enable T.37 Fax to Mail services
- Configure prompt settings for Voice and Fax Detection
- Set the default fax printer to use for Fax Printing

To enable and configure T.37 Fax to Mail Services settings, follow these steps.

- 
- STEP 1** In the Hostname device pull-down menu, choose the UC500.
- STEP 2** Click the **Enable Fax to Mail** checkbox.
- STEP 3** Complete the fields on the Services tab as shown in the following table.

Settings	Description
<b>Incoming Fax Only</b>	<p>The Incoming Fax Only section of this page displays the version of the On Ramp Fax Only application that is installed.</p> <p>If T.37 Fax to Mail has not been configured for the system, the message “Pending Install (version 2.0.1.3)” is displayed. The On Ramp application will be uploaded and installed on the UC500 when you apply the configuration.</p>
<b>Incoming Voice and Fax</b>	<p>Voice and fax detection provides the ability to detect whether an incoming call is voice or fax. This enables you to use a single incoming number for both voice and fax calls.</p> <p>CCA configures fax detection to “listen first” so that the call does not need to be connected. When a fax tone is detected on the call, it is processed and routed as a fax call. If no fax tone is detected, it is routed as a normal voice call.</p> <p>The version of the Voice and Fax Detection application that is installed is also displayed here. If T.37 Fax to Mail has not been configured for the system, the message “Pending Install” and the version of the Voice and Fax Detection application are displayed. The Voice and Fax Detection application will be uploaded and installed on the UC500 when you apply the configuration.</p>

Settings	Description
<b>Incoming Voice and Fax (continued)</b>	<p data-bbox="657 359 1024 390"><b>Prompt for Incoming Calls</b></p> <p data-bbox="657 422 1495 674">The detection process may delay incoming calls for up to 9 seconds. Default system prompts are provided for alerting callers and providing options for callers to avoid the delay and be connected immediately or send a fax. You can also record a custom prompt for this purpose (for example, you may want to do this if you require the prompt to be played in a different language).</p> <p data-bbox="657 705 1487 810">The default system prompt is “To send a fax, press the START key on your fax machine now. For voice calls, press any key or stay on the line.”</p> <p data-bbox="657 842 1057 873">Choose ones of these options</p> <ul data-bbox="699 905 1487 1440" style="list-style-type: none"> <li>▪ <b>Custom.</b> Record a custom prompt for incoming calls. When selected, click <b>Add File</b> to record and upload a custom prompt.</li> <li>▪ <b>System (Chinese).</b> Use the Chinese language system default prompts.</li> <li>▪ <b>System (English).</b> Use the English language system default prompts. This is the default value.</li> <li>▪ <b>System (Spanish).</b> Use the Spanish language system default prompts.</li> <li>▪ <b>None.</b> Choose this option if you are not using Voice and Fax Detection (mailboxes that receive incoming faxes are configured as Fax Only).</li> </ul> <p data-bbox="657 1472 1487 1640">The built-in TFTP server in CCA is used for uploading and downloading system prompts. Make sure that the firewall settings on your PC allow TFTP traffic to and from the UC500 and that there are no third-party TFTP servers running on your PC.</p> <p data-bbox="657 1671 1422 1745">For instructions on how to record prompts using the CCA prompt recorder, see <a href="#">Sound Recorder, page 403</a>.</p>

Settings	Description
	<p><b>Custom Prompt File (Optional)</b></p> <p>Displays the filename of the prompt you recorded for incoming calls. This menu only appears if a custom prompt is recorded.</p>
<b>Fax Printing</b>	<p>Fax mail may be printed to any dialable number or to the default fax printer configured.</p> <p>If you want to enable Fax Printing, you must have a local fax machine connected to an FXS port on the UC500 and the FXS port must be assigned a FAX role. To do this, go to <b>Configure &gt; Telephony &gt; Ports and Trunks &gt; FXS Ports</b>.</p> <p>Only FXS ports that have been assigned a Fax role are available for selection.</p> <p>The version of the Off Ramp fax printing application that is installed is also displayed. If T.37 Fax to Mail has not been configured for the system, the message “Pending Install (version 2.0.1.1)” is displayed. The Off Ramp fax printing application will be uploaded and installed on the UC500 when you apply the configuration.</p> <hr/> <p><b>Default Fax Printer</b></p> <p>To configure a default fax printer:</p> <ol style="list-style-type: none"> <li>1. Set the default printer to use.</li> <li>2. Click <b>OK</b> or <b>Apply</b>.</li> </ol>

---

## Configuring Mailboxes for Incoming Faxes

Incoming faxes may be stored and forwarded to voice mailboxes. All mailboxes can receive faxes, provided they have an incoming dial plan. The same mailbox is used for storing both faxes and voice mails.

Also, you can disable the fax without impacting the existing messages in the mailbox. However, after faxing is disabled for a mailbox, the system rejects faxes addressed to that mailbox from a fax machine.

Mailboxes configured with an email destination may receive faxes as email. To configure email destinations, go to **Telephony > User and Extensions > Voicemail** and select the Notifications tab to enable email notification via email.

**NOTE:** Unified Messaging may also be used to receive faxes as email. To configure Unified Messaging, go to **Applications > Smart Applications > Smart Applications Manager**.

## Adding Mailboxes to Receive Incoming Faxes

Only mailboxes associated with incoming numbers on PSTN trunks may be added. To configure incoming numbers go to **Telephony > Dial Plan > Incoming**.

To add mailboxes that will receive incoming faxes, follow these steps:

- 
- STEP 1** Click **Add** on the Mailboxes tab in the T.37 Fax to Email window. The Add Mailboxes to Receive Incoming Faxes window appears.
  - STEP 2** In the Add Mailboxes to Receive Incoming Faxes window, use the **Add**, **Remove**, and **Select All** buttons to move selected users between the Available Mailboxes and Selected Mailboxes lists.
  - STEP 3** Click **OK** to return to the T.37 Fax to Email window.
- 

## Removing Mailboxes from the List

To remove mailboxes to receive incoming faxes follow these steps:

- 
- STEP 1** From the Mailboxes tab, select the desired Mailbox
  - STEP 2** Click **Delete**.
-

---

**STEP 3** Click **OK** or **Apply**.

---



## Dial Plan

This section covers incoming and outgoing dial plan configuration, including the following topics:

- [Incoming Dial Plan](#)
- [Outgoing Dial Plan](#)
- [PSTN Trunk Groups](#)
- [Dial Plan Templates](#)

### Incoming Dial Plan

To configure the incoming dial plan, choose **Configure > Telephony > Dial Plan > Incoming Dial Plan** from the feature bar.

#### Before You Begin

Before configuring incoming dial plan settings for direct dialing and incoming FXO calls, make sure that settings in the PSTN Trunks window for BRI, PRI, and FXO trunks have been configured (**Configure > Telephony > Ports and Trunks > PSTN Trunks**). If SIP trunks are used, make sure these are configured (**Configure > Telephony > Ports and Trunks > SIP Trunk**). Auto Attendant, hunt groups, and call blast groups should also be configured so that they are available as destinations for incoming FXO calls and DID numbers.

The incoming dial plan window has these tabs:

- [Incoming FXO Calls](#)
- [Direct Dialing](#)

## Incoming FXO Calls

On the Incoming FXO Calls tab, choose the destination for incoming calls on FXO ports.

To configure destinations for incoming calls to FXO ports, select an FXO port from the list, edit settings as described below, then click **OK** or **Apply**.

Field	Description
<b>Description</b>	Description for this FXO port. You can edit the default value, which initially is the same as the FXO port number, for example, 4 FXO-0/0/1.
<b>Trunk</b>	Read-only field that contains the FXO port number, for example, 4 FXO-0/0/1.
<b>Destination Type</b>	<p>Destination for inbound calls to this FXO trunk. Choose from the following destination types.</p> <ul style="list-style-type: none"> <li>▪ CO_LINE (direct “Central Office” PSTN trunk line)</li> <li>▪ OPERATOR</li> <li>▪ AUTO_ATTENDANT</li> <li>▪ BLAST_GROUP</li> <li>▪ HUNT_GROUP</li> <li>▪ B_ACD (Basic ACD service extension)</li> </ul>
<b>Destination</b>	<p>If you choose AUTO_ATTENDANT, HUNT_GROUP, BLAST_GROUP, or B_ACD, as the extension type, select the appropriate extension or group from the list of those configured on your system.</p> <p>If you choose Operator as the extension type, manually enter the extension to be used for the Operator for the site.</p> <p>If you choose CO_LINE, a read-only description is displayed, for example, Direct Trunk Line - CO1.</p>

## Direct Dialing

On the Direct Dialing tab, set up translation rules for mapping incoming PSTN numbers to internal extensions. Two types of translations can be set up:

- **Direct Dial to Internal User Extensions.** Configure direct inward dial (DID) numbers to ring internal extensions. Use this method to create a one-to-one mapping between a single DID number and a single internal extension. See [Direct Dial to Internal User Extensions, page 427](#).
- **Direct Dial to AA, Groups, Operator.** Configure a DID number or range of DID numbers to ring a hunt group, call blast group, Basic ACD service, Auto Attendant or Operator extension. See [Direct Dial to Auto Attendant, Groups, Operator, page 429](#).

**IMPORTANT** For SIP trunking, DID mappings for Auto Attendant and voice mail extensions must be configured through the settings on the Auto Attendant and Voicemail windows, not through the DID settings in the Incoming Dial Plan window.

## Direct Dial to Internal User Extensions

This window appears when you click **Add** from the Direct Dial to Internal User Extensions section in the Incoming Dial Plan window.

### Overview

From this window, you configure DID (direct inward dial) numbers to ring internal user extensions. This is done by creating translation rules to define the mapping between each DID number and its corresponding internal extension. A single DID number is mapped to a single internal extension.

The DID number provided by your carrier can have any number of digits. Consult your carrier for the DIDs that have been assigned for your installation.

The maximum number of DID translation rules is 15. However, a single translation rule can be used to map multiple DID numbers to internal extensions by using a range, as shown in this example.

**DID Translation Settings**

Setting	Value
DID Range Start	972555 1000
DID Range End	972555 1005
Internal Number Start	200
Internal Number End	205

**Resulting Configuration**

Incoming calls to this DID number	Ring this extension
972-555-1000	Ext. 200
972-555-1001	Ext. 201
972-555-1002	Ext. 202
972-555-1003	Ext. 203
972-555-1004	Ext. 204

**Procedures**

To configure a translation rule for direct dial to internal user extensions, click **Add**, complete the fields in the Direct Dial to Internal User Extensions window as described below, then click **OK** or **Apply**.

Field	Description
<b>Description</b>	Description for the DID extension mapping.
<b>Trunks</b>	Choose the digital trunk type from the list that corresponds to the carrier providing the DID numbers, for example, SIP Trunk, BRI Trunk, or PRI Trunk.

Field	Description
<b>DID Numbers</b>	<p>DID (PSTN) numbers to map to the corresponding internal extensions.</p> <ul style="list-style-type: none"> <li>To map only one number, enter the same number for the <b>DID Range Start</b> and <b>DID Range End</b>.</li> <li>To map a range of numbers, enter starting and ending numbers to define the range.</li> <li>DID numbers can begin with a “+” character.</li> </ul>
<b>Internal Numbers</b>	<p>Internal extension numbers to map to DID numbers.</p> <ul style="list-style-type: none"> <li>To map only one number, enter the same number for the <b>Internal Number Start</b> and <b>Internal Number End</b>.</li> <li>To map a range of numbers, enter starting and ending numbers for internal extensions to define the range.</li> <li>The number of internal extensions specified by the range must match the number of DID numbers specified by the DID range.</li> </ul>

## Direct Dial to Auto Attendant, Groups, Operator

This window appears when you click **Add** from the Direct Dial to Auto Attendant, Groups, Operator section in the Incoming Dial Plan window.

From this window you create DID translations to map one or more incoming PSTN numbers to an Auto Attendant, hunt group, call blast group, Basic ACD service, or operator.

To configure direct dial from one or more PSTN numbers to a hunt group, blast group, Basic ACD service, Operator extension, or the Auto Attendant, click **Add**, complete the fields in the **Direct Dial to Auto Attendant, Groups, Operator** window as described below, then click **OK** or **Apply**.

Field	Description
<b>Description</b>	Description for the DID extension mapping.

Field	Description
<b>Trunks</b>	Choose the voice trunk type from the list that corresponds to the carrier providing the DID numbers, for example, SIP Trunk, BRI Trunk, or PRI Trunk.
<b>DID Numbers</b>	<p>DID (PSTN) numbers to map to the corresponding internal destinations.</p> <ul style="list-style-type: none"> <li>To map only one number, enter the same number for the <b>DID Range Start</b> and <b>DID Range End</b>.</li> <li>To map a range of numbers, enter starting and ending numbers to define the range.</li> <li>DID numbers can begin with a “+” character.</li> </ul>
<b>Destination Type</b>	<p>Choose from the following internal destinations types. If a destination type is not listed, no internal extensions of that type are configured on the system:</p> <ul style="list-style-type: none"> <li>OPERATOR</li> <li>AUTO_ATTENDANT</li> <li>BLAST_GROUP</li> <li>HUNT_GROUP</li> <li>B_ACD (Basic ACD service extension)</li> </ul>
<b>Destination</b>	<p>If you choose AUTO_ATTENDANT, HUNT_GROUP, BLAST_GROUP, or B_ACD, as the destination type, select the appropriate extension or group from the list of those configured on your system.</p> <p>If you choose Operator as the Destination Type, manually enter the extension to be used for the Operator for the site.</p>

## Outgoing Dial Plan

This window appears when you choose **Configure > Telephony > Dial Plan > Outgoing** from the feature bar.

**NOTE** Telnet must be enabled in order to configure dial plan features.

The Outgoing Dial Plan window has these tabs:

- **Outgoing Call Handling**
- **PSTN Trunk Groups**
- **Caller ID**

### **Outgoing Call Handling**

On the Outgoing Call Handling tab, you can:

- **Choose a Numbering Plan Locale**
- **Set the Default Access Code and Digit Collection Timeout**
- **Configure Outgoing Numbers**
- **Add or Edit an Outgoing Number**

### **Choose a Numbering Plan Locale**

From the Numbering Plan Locale menu, choose one of the following:

- A built-in numbering plan template for a specific locale, for example, Template: Australia or Template: North America.

The following locales have built-in templates: Argentina, Australia, Austria, Belgium, Brazil, Chile, China, Columbia, France, Germany, Indonesia, Ireland, Italy, Japan, Malaysia, Mexico, Netherlands (6-digit or 7-digit), New Zealand, North America (7-digit and 10-digit), Norway, Philippines, Singapore, Slovenia, Spain, Switzerland, UK, Taiwan, Thailand, and Venezuela.

For North America, both 7-digit and 10-digit dial plan templates are provided so that you do not have to manually edit the dial plan for local dialing. Similarly, 6-digit and 7-digit templates are provided for the Netherlands.

- Define a new locale (creates a new, blank numbering plan).
- A custom template based on one of the default templates with modifications or a custom imported template.

Once you choose a numbering plan locale, the tab updates to display the outgoing numbers defined in the selected locale or, if you selected **Define New Locale**, all outgoing numbers are cleared.

Once you have added or modified any of the outgoing numbers in the default template for a locale, a new dial plan is created with your changes, leaving the original template intact.

When you first apply an outgoing dial plan template, if that template contains any blocked numbers, you are asked whether you want to globally enable or disable call blocking on all user phones. This global option appears only during initial dial plan configuration. If you add or remove blocked numbers after the template is applied, this global enable/disable option is not available. Call blocking on phones added after the dial plan template is applied must be manually configured on the User Extensions tab in the Voice window.

For more information, see [Dial Plan Templates, page 437](#).

### Set the Default Access Code and Digit Collection Timeout

An access code is a single-digit number that phone users dial to place external calls. In the **Access Code** field, enter a single digit, from 0 to 9 or use the default value of 9. This sets the default access code.

If you change the default Access Code for an existing dial plan, Configuration Assistant displays a dialog asking you whether or not you want the default access code to be applied to all outgoing numbers. Choose **Yes** to update all outgoing numbers in the existing dial plan.

In the **Digit Collection Timeout** field, enter the number of seconds (from 2 to 120) to wait for user input when dialing or use the default value of 5.

### Configure Outgoing Numbers



**CAUTION** All changes to dial plan configuration for outgoing numbers must be tested. Errors in dial plan configuration can result in customers being unable to place calls.

Cisco strongly recommends that you use an actual IP phone to test the outbound dial plan after you have applied the configuration. CCA checks for conflicts within the UC500, but checking for incompatibility with the Telco provider is out of scope for CCA.

For example, some North American Telco providers require the PSTN access prefix to be sent to the CO, while other providers require the access code to be stripped.



You may need to **Add or Edit an Outgoing Number** in the numbering plan to:

- **Change permissions for certain types of calls.**

Prevent users from dialing certain numbers (call blocking). Call blocking prevents calls to restricted numbers. When a user attempts to place a call to a blocked number, a fast busy signal is played for approximately 10 seconds. The call is terminated, and the line is placed back on-hook. Call blocking can be enabled and disabled on all types of phones except SIP phones. Call blocking is controlled separately from user permissions and must be enabled on a per-phone basis from the More options window on the Users tab in the Voice window. For more information, see **Call Blocking Example, page 436**.

Call permissions and restricted numbers in the dial plan do not apply to CO (central office) trunk lines. The **Block Restricted Calls** and **Permissions** options are not available for CO Lines.

The Telephony Setup wizard does not globally enable call blocking for user phones when the dial plan template is applied. After the wizard completes, you must manually configure call blocking on each phone.

- **Permit phone users to place calls to specific numbers that are outside their normal permissions.** For example, phone users permitted to dial National Plus numbers may also need to be able to dial an international number to reach the main corporate office. In that case, you can add an outgoing number specifically for that purpose and set its permission to National Plus.
- **Edit the Trunk List to route calls to the appropriate trunk in order of preference.** For example, if you select PSTN Only for the Trunk List for Local and Local Plus numbers, all local/local plus calls and emergency calls are routed to PSTN trunks. If you select SIP then PSTN as the Trunk Type for International and International Plus calls, these are routed to available SIP trunks first (since they are free), with fallback to PSTN trunks.

### **Add or Edit an Outgoing Number**

To add an outgoing number, click **Add Number** to insert a new row in the table, configure settings as described in the following table, then click **OK** or **Apply**.

Field	Description
<b>Permissions</b>	<p>Permission level for the outgoing number. You can also define patterns for call blocking.</p> <p>Each outgoing number has a permission level. The permission level corresponds to the <b>Permissions</b> and <b>Block Restricted Calls</b> settings that are configured on each phone. Permission levels are cumulative, as listed below:</p> <ul style="list-style-type: none"> <li>▪ <b>Blocked.</b> Restricted number. When <b>Block Restricted Numbers</b> is enabled for a phone, calls to these numbers are blocked.</li> <li>▪ <b>Emergency.</b> Outgoing number for emergency services calls. Emergency numbers are included in all permission levels.</li> <li>▪ <b>Toll-Free.</b> Outgoing number for free calls that is included in all permission levels</li> <li>▪ <b>Local.</b> Includes Emergency, Toll-Free, and Local calls.</li> <li>▪ <b>Local Plus.</b> Includes Emergency, Toll-Free, Local, and Local Plus numbers</li> <li>▪ <b>National</b> Includes Emergency, Toll-Free, Local, Local Plus, and National numbers</li> <li>▪ <b>National Plus.</b> Includes Emergency, Toll-Free, Local, Local Plus, National, and National Plus numbers.</li> <li>▪ <b>International.</b> Includes Emergency, Toll-Free, Local, Local Plus, National, National Plus, and International numbers.</li> <li>▪ <b>International Plus.</b> Includes Emergency, Toll-Free, Local, Local Plus, National, National Plus, International, and International Plus numbers.</li> <li>▪ <b>Unrestricted.</b> Includes all permission levels except Blocked.</li> </ul>
<b>Description</b>	Description of the outgoing number rule. For blocked calls, the description is always Restricted Number, and is displayed automatically.

Field	Description
<b>Access Code</b>	Access code, if needed, for dialing the outgoing number. In most cases, this will be the default access code defined for external calling. You can also enter a different access code for an outgoing number.
<b>Begins With</b>	Number or pattern to be matched. <ul style="list-style-type: none"><li>▪ The pattern must be unique.</li><li>▪ Numbers and patterns are matched beginning with the first digit.</li><li>▪ A number that includes the pattern, but does not begin with the pattern is not matched.</li><li>▪ When specifying a pattern, an “x” matches any digit from 0 through 9. A series of numbers enclosed in brackets ([089]) matches any one of the digits.</li><li>▪ You can also specify a range. For example, [2-9] matches any single digit in the range from 2 to 9.</li></ul>
<b>Number of Digits</b>	Enter the number of digits in the dialed number or select <b>Variable</b> . The number of digits cannot be smaller than the prefix defined in the <b>Begins With</b> field and cannot be larger than 15.
<b>Dial Pattern</b>	As you enter patterns in the <b>Begins With</b> field, the <b>Dial Pattern</b> column in the table updates to display the dial pattern that is matched, including the access code. The <b>Dial Pattern</b> column is read-only.
<b>Trunk Priority</b>	Trunk priority settings enable you to assign priority to the outgoing trunk with the lowest cost for a given type of call.  Specify a trunk priority for the outgoing number. Choices include <b>PSTN only</b> , <b>SIP only</b> , <b>PSTN then SIP</b> , <b>SIP then PSTN</b> , or <b>None</b> .

Field	Description
<b>Configure Priority</b>	<p><i>Optional.</i> Click the <b>Configure Priority</b> button to open the Trunk List Details dialog, where you can view or edit trunk list settings. To edit trunk list settings:</p> <ol style="list-style-type: none"> <li>1. Click in the <b>Preference</b> column that corresponds to the trunk whose priority you want to edit and select a new priority, from 1 (highest) to 10 (lowest).</li> <li>2. Click <b>Add Trunk</b> to add trunk groups that are configured on the system were not added to outgoing numbers when they were created. When a trunk is created, you can choose whether you want to add it to the trunk list for all outgoing numbers. If you did not choose to add it at the time of creation, use this option to add it to an outgoing number.</li> <li>3. Click <b>Delete Trunk</b> to remove trunks from the list (for example, you can remove a SIP trunk if you want all calls to be routed through ports connected to the PSTN).</li> <li>4. The <b>Forward Access Code</b> controls whether or not the access code dialed by the user is forwarded to the trunk. By default, Forward Access Code is set to No. Do not modify this field unless it is required by the Service Provider.</li> <li>5. Click <b>OK</b>.</li> </ol>

To edit an outgoing number, locate the number you want to edit, click in the row to select it, make your changes, then click **OK**.

To delete an outgoing number, locate the number you want to delete, click in the row to select it, click **Delete**, then click **OK**.

### Call Blocking Example

To configure the dial plan so that outgoing calls to all numbers that begin with 1976 for the North American Dial Plan are blocked, follow these steps.

- 
- STEP 1** From the Outgoing Numbers window, click **Add Number**.
  - STEP 2** From the **Permissions** menu, choose **Blocked** and enter the access code.
  - STEP 3** In the **Begins With** field, enter 1976.
  - STEP 4** In the **Number of Digits** column, enter 11.

- 
- STEP 5** The **Trunk List** and **Configure Priority** settings do not apply to blocked numbers.
- STEP 6** Click **OK**.
- 

Once you have modified the dial plan to add blocked numbers, you must enable **Block Restricted Calls** on each phone for which you want to block these numbers. To access this setting, choose **Configure > Telephony > Users and Extensions > Users and Phones**, select the User Extensions tab, then configure call blocking for each Normal or Shared line button on the phone.

### Dial Plan Templates

Through dial plan templates, Configuration Assistant provides support for tailoring the outgoing dial plan to meet locale-specific requirements. From the Outgoing Handling tab, you can:

- **Define a new locale** that is not based on an existing template. To define a new locale, choose **Define New Locale** from the Numbering Plan Locale menu. This creates a new, blank numbering plan locale.
- **Import a template.** When a template is imported, it is copied to the location that contains the Configuration Assistant built-in dial plan templates. Subsequent launches of Configuration Assistant display the new template as an option in the Numbering Plan Locale menu. To import a template, click **Import Template**.
- **Export a new locale or an existing configuration as a template.** When a template is exported, you are prompted to enter a unique name for the template. It is saved in the same location as the built-in Configuration Assistant dial plan templates. Subsequent launches of Configuration Assistant display the exported template in the Numbering Plan Locale menu on the Outgoing Call Handling tab. To export a locale or existing configuration as a new template, click **Export as Template**.
- **Delete a locale.** To delete a locale, choose **Delete Locale** from the Numbering Plan Locale menu. Use the arrow keys in the Delete Locale Template dialog to move available locale templates to the deleted locale templates list, then click **OK**. Click **OK** again when prompted to confirm the deletion.

## PSTN Trunk Groups

PSTN trunk groups provide a way to logically group voice ports into trunk groups to allow flexibility in choosing voice ports for outgoing calls.

**NOTE** The Least Cost Routing support addressed in this section refers to the process of manually selecting a PSTN or SIP trunk, by dialing a pre-defined access code.

Least Cost Routing refers to the ability to choose the outgoing trunk with the lowest cost for a given type of call.

Configuration Assistant provides support for Least Cost routing by providing the ability to:

- Configure trunk priority for outgoing numbers
- Assign a hunt scheme for voice ports within a trunk group
- Create and manage new PSTN trunk groups to form logical groupings of voice ports

To create a new, custom PSTN trunk group, select the PSTN Trunk Group tab and click **Add**. See [Trunk Group Parameters, page 441](#).

## Caller ID

See these sections for details on how to configure Caller ID settings:

- [Specify the Caller ID Per-Call Block Code](#)
- [Specify the Default Caller ID to Display for Each PSTN Trunk Group](#)
- [Override the Default Caller ID Number for Specific Extensions](#)

### Specify the Caller ID Per-Call Block Code

The **Caller ID Per Call Block Code** is a four-digit code that phone users can dial before making a call. The code must begin with an asterisk (for example, \*111).

Users dial the code before making any call on which they do not want their number displayed on the called-party phone. The caller ID is sent, but its presentation parameter is set to “restricted” so that the caller ID is not displayed.

To configure the code, enter a 3-digit number in the Caller ID Per Call Block Code field and click **Apply** or **OK**.

The asterisk (\*) is automatically inserted by CCA. For example, if you enter 222 as the per-call block code, phone users will dial \*222 to block display of their Caller ID for a call.

---

### Specify the Default Caller ID to Display for Each PSTN Trunk Group

The Caller ID Main PSTN Number is the caller ID number that is displayed by default for all outgoing calls from a SIP or PSTN trunk group.

The Caller ID tab lists all default and custom PSTN trunk groups or SIP Trunk configured on the system, along with the currently configured Caller ID Main PSTN Number for each trunk group. By default, the Caller ID Main PSTN number uses the main PSTN number that was configured when the trunk was created.

To modify the caller ID for a trunk group, follow these steps.

- 
- STEP 1** On the Caller ID tab in the Outgoing Dial Plan window, click on a PSTN trunk group to select it.
  - STEP 2** Click in the **Caller ID Main PSTN Number** field for the selected PSTN trunk group.
  - STEP 3** Enter the phone number to display for the caller ID. The number can have up to 15 digits. The number can begin with a “+” character.
  - STEP 4** Click **Apply** or **OK**.
- 

You can override the default caller ID for specific extensions. See [Override the Default Caller ID Number for Specific Extensions, page 439](#).

### Override the Default Caller ID Number for Specific Extensions

To override the default caller ID for specific extensions, follow these steps.

- 
- STEP 1** On the Caller ID tab in the Outgoing Dial Plan window, click on a PSTN trunk group to select it.
  - STEP 2** Click **Add**.  
  
The Add Caller ID for Internal Extensions dialog displays. Complete the fields in this dialog as described in [Add Caller ID for Internal Extensions, page 440](#).  
  
You can add up to 14 caller ID override entries.
  - STEP 3** Click **Apply** or **OK**.
- 

To modify existing caller ID override settings, highlight the caller ID override entry in the list and click **Modify**.

## Add Caller ID for Internal Extensions

This window appears when you select a PSTN Trunk Group on the Caller ID tab of the Outgoing Dial Plan window and click **Add** or **Modify**.

Configure the caller ID for internal extensions as described below, then click **OK**. You can add up to 14 caller ID override entries. By specifying a range of internal extensions to map to one or more caller ID numbers, you can reduce the number of entries used.

Field	Description
<b>Internal Extension Start Number</b>	Enter starting and ending internal extension numbers to override the default caller ID for a range of numbers.
<b>Internal Extension End Number</b>	To override the default caller ID for a single extension, enter the same extension number in the Internal Extension Start Number and Internal Extension End Number fields.
<b>Caller ID Start Number</b>	Enter starting and ending numbers to override the default caller ID for the specified range of internal extensions. The numbers can begin with a "+" character; however, if the preceding "+" is used for the start number, it must also be used for the end number.
<b>Caller ID End Number</b>	<p>If you are mapping a range of internal extensions to a range of caller ID numbers, the trailing digits must match. For example, if you enter 205 to 210 as the starting and ending numbers for internal extensions, the starting and ending caller ID numbers must end in -05 and -10.</p> <p>For a single PSTN trunk group, internal extension ranges cannot overlap.</p> <p>To override the default caller ID for a single extension or to display the same caller ID number for a range of extensions, enter the same number in the Caller ID Start Number and Caller ID End Number fields.</p>



## Examples

To override the default caller ID for extensions 205 through 225 with caller ID numbers 12229990005 through 12229990005:

- Enter 205 for the Internal Extension Start Number.
- Enter 225 for the Internal Extension End Number.
- Enter 12229990005 for the Caller ID Start Number.
- Enter 12229990025 for the Caller ID End Number.

To display 12229991200 as the caller ID for internal extensions 200 through 230:

- Enter 200 for the Internal Extension Start Number.
- Enter 230 for the Internal Extension End Number.
- Enter 12229991200 for both the Caller ID Start Number and the Caller ID End Number.

To override the default caller ID for extension 505 only with caller ID 12229991100:

- Enter 505 for both the Internal Extension Start Number and the Internal Extension End Number.
- Enter 12229991100 for both the Caller ID Start Number and the Caller ID End Number.

## Trunk Group Parameters

This window displays when you click **Add** or **Modify** on the PSTN Trunk Group tab in the Outgoing Dial Plan window.

All voice ports are initially placed in default groups based on the SKU type. For example, ALL\_FXO or ALL\_BRI. These default groups can be modified.

When you create a new PSTN trunk group, you are prompted to choose whether you want to add the new trunk as an option for all outgoing numbers or manually add the trunk group to selected numbers as needed.

When you create a new SIP trunk or T1/E1 trunk group, you are prompted to enter a main PSTN number for these trunks. The main PSTN number is required for trunk groups that are not empty. If you create a trunk group, but do not assign voice ports as members, the main PSTN number is not required. If there are voice ports assigned to that trunk group, it is required.

When creating or modifying a PSTN Trunk Group, configure settings as described below, and click **OK**.

Field	Description
<b>Trunk Group</b>	Descriptive name for this trunk group.
<b>Hunt Scheme</b>	<p>The hunt scheme determines how member voice ports are chosen for outbound calling. The following options are available:</p> <ul style="list-style-type: none"> <li>▪ <b>sequential</b>. Selects the voice port with the lowest preference.</li> <li>▪ <b>round-robin</b>. Selects the next voice port with free timeslots.</li> <li>▪ <b>random</b>. Randomly selects a timeslot.</li> <li>▪ <b>longest-idle</b>. Selects the voice port with the timeslot that is idle the longest.</li> <li>▪ <b>least-idle</b>. Selects the voice port with the timeslot that is idle the least.</li> </ul>
<b>Trunk Type</b>	Choose a trunk type from the list of trunk types available on your system.
<b>Trunk Group Members</b>	<p>Choose trunk group members from the list of available voice ports for the selected trunk type.</p> <p>A voice port can belong to only one PSTN trunk group.</p> <p>You cannot mix different types of PSTN trunks in a single trunk group. For example, an analog FXO port cannot be a member of a trunk group that contains ISDN BRI ports.</p> <p>Use the <b>Up</b> and <b>Down</b> arrow keys to re-order the list of voice ports, if the selected hunt scheme is sequential or round-robin.</p>

# Site Management

These topics are covered:

- **Multisite Manager**
- **Maximum Calls (Call Admission Control)**

## Multisite Manager

Use the Multisite Manager to configure, manage, and monitor up to 5 Cisco SBCS customer sites connected through a full-mesh VPN.

This feature enables end users at connected sites to place intersite calls using abbreviated dialing and share data over a secure WAN connection. Multisite deployments are well-suited for small businesses with up to 5 locations.

Supported deployment models include customer sites with a single UC500 or a UC500 behind a Cisco SR500 secure router for advanced security features.

- **Multisite Design Requirements and Guidelines**
- **Multisite Configuration Procedures**
- **Multisite Status Monitoring**
- **Voice Features Supported Across Multiple Sites**

### Multisite Design Requirements and Guidelines

Only the following network topologies are supported for individual customer sites that are members of a multisite deployment. Any of these site topologies can be combined as long as the total number of sites is 5 or fewer. The sites are configured with a full-mesh VPN — that is, every site has a direct link to every other site.

- A single UC500 connected to the WAN.

- A single SR520-T1 secure router combined with a UC500. The SR520-T1 is connected to the WAN and provides advanced security features, and the UC500 provides voice and data to the site. In this type of deployment, the data VLAN must be unique for both the SR520-T1 and the UC500.

For the current release, only the model SR520-T1 secure router is supported for use in Cisco SBCS multisite deployments configured using CCA.

**IMPORTANT** Each site *must* have a UC500 for voice and data. The Multisite Manager cannot be used to configure any of the following types of deployments:

- A standalone SR520-T1 router as one of the sites
- A data-only, site-to-site VPN between two or more SR500 secure routers
- A remote phone behind an SR520-T1 without a UC500

This diagram shows a simple example of a deployment with two sites that illustrates the supported topologies and some of the design requirements discussed in this section.

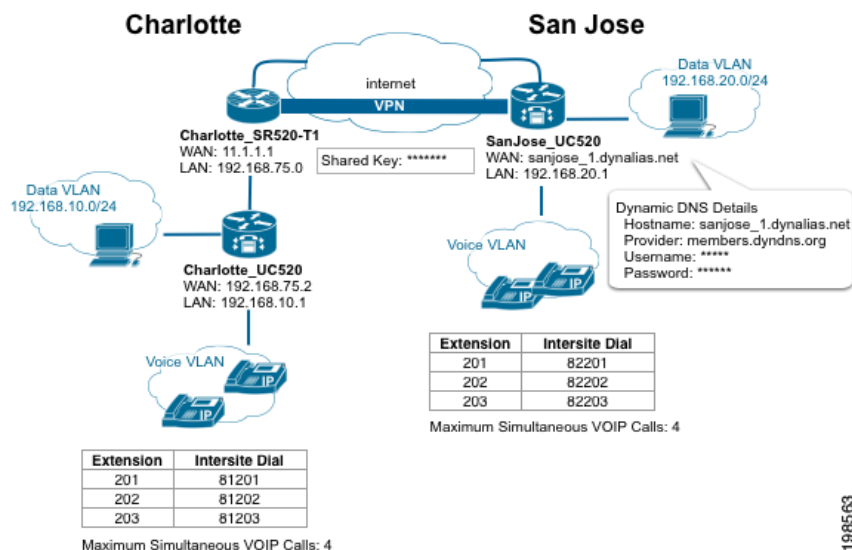

The above example illustrates these key elements of multisite configuration:

- **Site topology.** The Charlotte site provides an example of a site that has a UC500 behind an SR520-T1, while the San Jose site has a UC500 only.
- **Data VLAN IP addressing must be unique.** Since the data VLAN IP addresses must be unique across all sites for any UC500 and also for any SR520-T1, the data VLAN IP for the UC500 at the Charlotte site is set to 192.168.10.1/24, and the data VLAN IP for the UC500 San Jose is set to

192.168.20.1/24. The VLAN IP for the SR520-T1 at the Charlotte site is 192.168.75.0/24, and there is no SR520-T1 present at the San Jose site (otherwise a unique data VLAN IP would also be required for it).

- **Dial plan and intersite dialing.** For this configuration, we have chosen to use an intersite dialing prefix of “8.” The Charlotte site ID is set to “1”, and the San Jose site ID is set to 2. As shown in the example, phone users dial the *IntersiteDialingPrefix + Site ID + extension* to reach other sites. Both sites have their extension length set to 3. Although it is not required that sites use the same extension length, it is recommended for ease of use and configuration.
- **Static IP or DHCP WAN IP addressing is supported.** The Charlotte site uses a static WAN IP address, while the San Jose site is configured to use DHCP. Since DHCP is used, Dynamic DNS (DDNS) is configured for the San Jose site.
- **Full-mesh VPN with authentication using pre-shared key.** A global pre-shared key is configured identically for each site to provide authentication for the VPN tunnel.
- **Call admission control.** Both sites are configured to allow a maximum of 4 simultaneous calls over the WAN.

This table lists and describes multisite design requirements and guidelines in more details.

**IMPORTANT** Existing out-of-band configuration is not supported by the Multisite Manager. You must remove existing out-of-band multisite configuration before you can use the Multisite Manager.

Configuration Item	Requirements/Recommended Guidelines
Number of sites	Up to 5 sites in a full-mesh topology.

Configuration Item	Requirements/Recommended Guidelines
Number of IPsec tunnels	<p>For UC520 and UC540 platforms, each customer site supports up to 10 IPsec tunnels. For UC560 platforms, each customer site supports up to 20 IPsec tunnels. This include EZVPN tunnels, SSL VPN tunnels, multisite VPN tunnels, and SPA525G phone VPN tunnels.</p> <p>When a site is part of a multisite deployment, <math>N-1</math> of these VPN tunnels are used for the full-mesh site-to-site VPN, where <math>N</math> is the number of sites. For example, if the multisite deployment for a UC540 platform has 4 sites, 3 IPsec tunnels are used for the full-mesh site-to-site VPN, leaving 7 tunnels available for EZVPN and/or SSL VPN.</p>
Firewall	Cisco Zone-Based Firewall (ZBF) on SR500 or Cisco IOS-based CBAC policy on the UC500. Third-party firewalls are not supported.
Data VLAN addressing	<p>The data VLAN IP address for each UC500 and SR520-T1 must be unique across all sites.</p> <p>If each site is at factory default, you must remember to modify the default data VLAN address during the initial configuration of each additional site member to ensure that it is unique. Use the Telephony Setup Wizard to configure the initial settings.</p> <p>If one of the remote sites has an existing data VLAN IP address that is not unique, you must modify its data VLAN address. For a site that is not at factory default state, this can only be done through the Multisite Manager.</p> <p>After modifying the data VLAN IP address, you will lose connectivity to the UC500, and must request and obtain a new IP address from the UC500. To do this, go to <b>Start &gt; Run</b> on your PC and enter <code>cmd</code> to open a command prompt window. At the command prompt, enter the command <code>ipconfig /renew</code>.</p>

Configuration Item	Requirements/Recommended Guidelines
WAN connection type	<p>Sites can use either DHCP with DDNS configured or static IP addressing.</p> <p>For sites that use DHCP to dynamically obtain an IP address, DDNS (Dynamic Domain Name Service) or some other DNS registration method must be used to manage dynamic addresses.</p> <p>When configuring DDNS, the DDNS provider name, hostname for each site, and authentication information (username and password) must be provided as part of the multisite connection configuration. See <a href="#">Configuring DDNS, page 460</a>.</p> <p>The DDNS hostname must be unique for each site.</p>

Configuration Item	Requirements/Recommended Guidelines
DDNS (Dynamic DNS) hosting service	<p>DDNS must be configured for sites with DHCP WAN connections that are part of a multisite deployment. Sites that are configured with a static IP address are not required to configure DDNS.</p> <p>These DDNS hosting services can be selected from the HTTP DDNS section in the Modify Internet Connection window (<b>Configure &gt; Routing &gt; Internet Connection &gt; Modify &gt; Connection Settings</b>).</p> <ul style="list-style-type: none"> <li>▪ cgi.tzo.com</li> <li>▪ dup.hn.org</li> <li>▪ members.dyndns.org</li> <li>▪ members.easydns.com</li> <li>▪ www.dynx.cx</li> <li>▪ www.justlinux.com</li> <li>▪ www.zoneedit.com</li> </ul> <p>Accounts with these DDNS providers must be established outside of Configuration Assistant.</p> <p><b>TIP</b> Cisco recommends that you upgrade from the free package to a paid or premium package from the DDNS provider. For example, some free packages are designed to expire due to inactivity (for example, if the IP address is not updated in 30 days). Loss of the DNS support for a domain name means that the VPN tunnels can become inoperable or fail to come up, resulting in service interruptions.</p>
Traffic Shaping/ Quality of Service (QoS)	<p><i>Optional.</i> Although this setting is optional, it is strongly recommended. Sites that have limited bandwidth should enable traffic shaping and configure QoS settings for multisite deployments.</p>
Codec	<p>You must choose either G.711 or G.729 as the codec to use for intersite calls. The G.729 codec offers higher compression, which can translate into significant bandwidth savings, but can result in poorer quality for some types of audio such as Music on Hold.</p>



Configuration Item	Requirements/Recommended Guidelines
Call Admission Control	<p><i>Optional.</i> Configure Maximum Calls (maximum simultaneous calls) to ensure voice quality for intersite and VoIP calls by helping to prevent the Internet connection from being over-subscribed.</p> <p>Configuration Assistant uses the currently configured QoS settings for upstream bandwidth, codec preference, and bandwidth reservation for voice media to provide recommendations for call admission control.</p>
Dial Plan	<p>Specify an <b>Intersite Dialing Prefix</b> for site-to-site calling.</p> <p>To dial another site, phone users must dial:</p> <p><i>Intersite Dialing Prefix + SiteID + Extension</i></p> <p>This feature allows for flexibility in extension assignments for sites. Prefix digit that are already in use are not available for selection.</p>
Extension length	<p>It is recommended, but not required, that all sites in a multisite configuration use the same extension length.</p>
Hostname	<p>To avoid confusion when selecting the hostname from Configuration Assistant menus, it is recommended that you define system hostnames to be unique across all sites.</p> <p>The system hostname is displayed in Configuration Assistant hostname selection menus and system prompts.</p>

## Multisite Configuration Procedures

The topics in this section cover multisite configuration procedures for supported configurations.

If you have not previously configured multisite connections on this UC500, the initial window provides an overview of configuration steps, with these options:

- **Manually Specify Multisite Settings.** Choose this option to go to the Multisite Configuration tab. See [Adding and Configuring Sites, page 451](#).

- **Import Multisite Configuration File.** Choose this option to import site settings that were previously exported to a configuration file on another site. See [Exporting and Importing Sites, page 463](#).

**NOTE** All multisite configuration procedures assume that the PC running Configuration Assistant is connected to an Ethernet port on the UC500 and has obtained an IP address from the UC500. When the UC500 is behind an SR520-T1 secure router, connect directly to the UC500 and use DHCP to obtain an IP address from the UC500.

- [Multisite Design Requirements and Guidelines](#)
- [Prerequisites for Multisite Configuration](#)
- [Adding and Configuring Sites](#)
- [Configuring DDNS](#)
- [Configuring Quality of Service \(QoS\)](#)
- [Maximum Calls \(Call Admission Control\)](#)
- [Exporting and Importing Sites](#)
- [Modifying a Site After the Initial Configuration](#)
- [Deleting a Site](#)

## Prerequisites for Multisite Configuration

Several prerequisites must be met before you can configure multisite connections. For more detailed information, see [Voice Features Supported Across Multiple Sites, page 467](#).

- Basic voice and data configuration must be established on the UC500, using either the Telephony Setup Wizard (recommended for sites that are configured from factory default settings) or using Configuration Assistant in expert mode. This includes:
  - Internet connection
  - Data VLAN IP address for each UC500 and SR520-T1 should be unique across all sites. If it is not, this can be modified later through the Multisite Manager.
  - Voice system initialization settings such as the default access code for external calling (**Configure > Telephony > Dial Plan > Outgoing > Outgoing Call Handling** tab).

- At a minimum, local telephony must be configured for calls within the site, preferably through the Telephony Setup Wizard.
- If the SR500 secure router is the edge device (that is, the UC500 at a site is behind an SR500), these settings must be configured:
  - WAN connection. If using an SR520-T1 secure router, you must run the T1 connection utility before running the Telephony Setup wizard.
  - Firewall and NAT are disabled on the UC500. When you run the Telephony Setup Wizard, you are automatically prompted to this as part of the setup.
  - The UC500 has a static WAN IP address of 192.168.x.2 where x is obtained from the SR500 data VLAN75.
  - The SR500 can route to the UC500 (simple static route to the data VLAN1). When you run the Telephony Setup wizard, these routes are established automatically.
  - The SR500 must have a network-wide unique address configuration for VLAN75.
- For sites using a DHCP WAN connection, the following information is required for DDNS configuration:
  - DDNS provider name
  - Unique hostname for each site
  - Account username and password from DDNS provider

## Adding and Configuring Sites

### Overview

If you are configuring multisite connections for sites with UC500 and SR500 platforms with factory default settings, the recommended steps for configuring connections among sites is as follows.

1. If any of the sites use an SR520-T1 secure router as the edge device, you *must* run the T1 Connection Utility first (before running the Telephony Setup Wizard). See the *Cisco Small Business Pro SR520-T1 Quick Start Guide* and the *UC500 and SR520-T1 Secure Router Setup* application note for instructions.
2. On the first site:
  - a. Verify that basic voice and data configuration is established on the UC500.

- b. Launch Configuration Assistant and configure Traffic Shaping/Quality of Service, Maximum Calls (Call Admission Control), and DDNS settings, as required. Sites configured with a DHCP WAN connection must configure DDNS in order to launch the Multisite Manager.
  - c. Launch the Multisite Manager (**Configure > Telephony > Site Management > Multisite Manager**) and configure global settings for multisite:
    - Pre-shared key for VPN tunnel authentication
    - Intersite dialing prefix
    - Codec to use for site-to-site VoIP calls (G.711 or G.729)
  - d. Configure multisite settings for the first site:
    - Site name
    - Site index
    - Number of digits in extensions.
  - e. Add the other remote sites and configure basic multisite settings:
    - Site name
    - WAN IP or Fully Qualified Domain Name (FQDN)
    - Internal addressing (data VLAN for the UC500, whether or not site has an SR520-T1)
    - Site dial pattern (site ID number and digits per extension)
  - f. Export multisite configuration settings configured above and apply the configuration.
3. On the second site and each of the remaining sites (up to 5 sites, maximum).
    - a. Verify that basic voice and data configuration is established on the UC500.
    - b. Configure Traffic Shaping/QoS, Maximum Calls, and DDNS settings, as required.
    - c. Launch the Multisite Manager and import the multisite configuration file that was created and exported from the first site.
    - d. Configure the same pre-shared key on the remote sites.

If you are connecting one or more existing sites, the steps are similar, except that instead of using the Telephony Setup Wizard, you establish the configuration in expert mode. If you need to change the default data VLAN IP address for the SR520-T1 or UC500, you can do this through the Multisite Manager when importing site data.

**Procedures**

- STEP 1** Verify that the requirements described in [Prerequisites for Multisite Configuration, page 450](#) are met.
- STEP 2** Verify that the PC running Configuration Assistant is directly connected to the UC500 and has obtained an IP address from the UC500.
- STEP 3** Launch Configuration Assistant and connect to the first site to be configured.
- STEP 4** From the feature bar, choose **Configure > Telephony > Site Management > Multisite Manager**.
- STEP 5** Select the Multisite Configuration tab.
- STEP 6** Configure these **Global Settings** for all sites.

Setting	Description
<b>Pre-Shared Key for Authentication</b>	<p>Enter a pre-shared key for authenticating remote sites. Use a pre-shared key that meets strong password criteria. From 8 to 127 characters can be entered; Spaces and “?” characters are not supported.</p> <p>Place a check mark in the <b>Display Key</b> box to enable display of the pre-shared key in plain text.</p> <p>Place a check mark in the <b>Allow Key to be Exported</b> box to enable export of the pre-shared key as plan text in the configuration file.</p> <p><b>IMPORTANT</b> The pre-shared key <i>must</i> be the same for all sites. By default, the pre-shared key is not exported in the multisite configuration. If you choose to export the key, it is exported as plain text. If the pre-shared key is not exported, you must manually re-enter it when importing multisite configuration data to other sites.</p>

Setting	Description
<b>Codec</b>	Preferred codec for intersite calls. Choose either: <ul style="list-style-type: none"><li>▪ <b>G711</b>: G711 codec is preferred.</li><li>▪ <b>G729</b>: G729 codec is preferred.</li></ul>
<b>Intersite Dialing Prefix</b>	<p>Choose a prefix from the drop-down list. The system detects prefix digits that are currently in use by the dial plan and only displays available selections. This is the prefix digit that phone users must dial when making calls to other sites</p> <p>To call remote sites, phone users dial the</p> <p><i>Intersite Dialing Prefix + SiteID + Extension</i></p> <p>For example, if the prefix digit for intersite dialing is 7 and a user at site 1 wants to dial extension 307 at site 2, the user must dial 72307 to reach that extension.</p>

**STEP 7** Review and edit settings for the first site. This is the site to which you are initially connected.

To begin editing site settings, click **Edit**. See [Site Settings, page 457](#) for more information.

The following information is read in and displayed from the site to which you are connected.

Setting	Description
<b>WAN Address</b>	Read-only. WAN IP address of this site.
<b>UC500 Data VLAN Address</b>	Read-only. UC500 Data VLAN IP address for this site.
<b>UC500 Data VLAN Subnet Mask</b>	Read-only. UC500 Data VLAN subnet mask for this site.
<b>SR500 Data VLAN Address</b>	Read-only. SR520-T1 data VLAN IP address, if an SR520-T1 is part of the customer site.
<b>SR500 Data VLAN Subnet Mask</b>	Read-only. SR520-T1 data VLAN subnet mask, if an SR520-T1 is part of the customer site.
<b>Site Dial Pattern</b>	Read-only field that displays the pattern that site members dial when making site-to-site calls over the WAN.

#### Connected to This Site

Click **Show Extra Configuration Options** to view the status (either **Configured** or **Not Configured**) of additional settings that might need to be configured for this site.

<b>DDNS</b>	<p><i>Optional.</i> Dynamic DNS configuration. Indicates whether or not DDNS is configured for this site. If DDNS is not configured and you are using DHCP, you must configure it before you can launch the Multisite Manager.</p> <p>Click the <b>Configured</b> or <b>Not Configured</b> link to open the Internet Connection window where you can modify these settings. See <a href="#">Configuring DDNS, page 460</a>.</p>
-------------	---

Setting	Description
<b>WAN Traffic Shaping</b>	<p><i>Optional, but strongly recommended.</i> Indicates whether or not Traffic Shaping and Quality of Service (QoS) settings are configured for the site. Although these settings are optional, they are strongly recommended for all sites, and especially sites with limited bandwidth. This specifies preferential handling for voice traffic over data when needed.</p> <p>Click the <b>Configured</b> or <b>Not Configured</b> link to open the Internet Connection window where you can modify these settings. See <a href="#">Configuring Quality of Service (QoS)</a>, page 461.</p>
<b>Call Admission Control</b>	<p>Indicates whether or not Call Admission Control (CAC) is configured for this site. Call admission control settings determine the maximum number of simultaneous calls for a site.</p> <p>If CAC is not configured, choose <b>Configure</b> &gt; <b>Telephony</b> &gt; <b>Maximum Calls</b> from the feature bar to access configuration options. See <a href="#">Maximum Calls (Call Admission Control)</a>, page 468.</p>

**STEP 8** Once you have reviewed and configured settings for the first site, click **Add Site** and configure settings for the rest of the sites that are part of the deployment.

See [Site Settings](#), page 457.

**STEP 9** When you are finished adding and configuring all remote sites, click **Apply**.

The **Apply** button is disabled (greyed out) if any of the required settings are not configured (for example, pre-shared key).

Once the changes are successfully applied, the **Export Multisite Configuration File** button becomes active.

**STEP 10** Click **Export Multisite Configuration File**.

The **Export Multisite Configuration File** button is unavailable (greyed out) until you have successfully applied the configuration.

**STEP 11** Save the configuration file to your PC. You can use the default filename or specify a different filename.



**IMPORTANT** Do not edit the XML configuration file. Any changes to the multisite configuration settings that are exported must be made through the Multisite Manager and re-imported to any sites that are part of the configuration. See [Exporting Sites, page 463](#).

**STEP 12** Click **OK**.

**STEP 13** Save your changes to the startup configuration to all devices in the customer site:

- Click **Configure** > **Save Configuration**, or
- Click **Save** when prompted to save the configuration before exiting Configuration Assistant.

**STEP 14** Import the multisite configuration file you just exported to each of the other sites using the procedures described in [Importing Sites, page 464](#).

Once you import and apply settings among all the remote sites, the VPN tunnels will begin to come up.

It can take up to three (3) minutes for the VPN tunnels to be established.

To manually bring the IPsec tunnels up, choose the Multisite Status tab and click **Connect to All Sites**.

---

## Site Settings

The Site Settings window appears when you:

- Click **Add Site** in the Multisite Manager window.
- Click **Edit** (Pencil icon) in the Multisite Manager window to edit settings for any of the sites.

Add or modify site settings as described in this table, then click **OK** to return to the Multisite Manager.

Changes made to site configuration will result in dropped calls and interruption in data traffic during the re-configuration.

Setting	Description
<b>Site Information</b>	
Site Name	Descriptive name for this site.
WAN IP Address or Domain	Public IP address (if static IP addressing is used) or fully-qualified domain name for the site (if DDNS is used).

### Internal Addressing

If you are directly connected to this site, Internal Addressing data is read from the current device configuration.

You can modify the data VLAN IP address for the UC500 or SR520-T1, but if you do, a warning dialog is displayed.

- You are prompted to verify or re-acquire an IP address on your PC before restarting Configuration Assistant and re-connecting to the customer site.
- No other multisite configuration is applied during this change. You must re-visit the Multisite Manager and configure or re-import your multisite settings once the VLAN has been updated.

UC500 Data VLAN IP Address	IP address of the data VLAN on the UC500. For example, 182.168.30.5.
UC500 Data VLAN Netmask	Subnet mask for the data VLAN on the UC500. For example, 255.255.255.0. If you are directly connected to this site, this information is read from the current configuration.
Site uses SR500 as WAN device	Check this option if the UC500 is behind an SR520-T1 secure router.
SR500 Data VLAN Network Address	IP address of the data VLAN on the SR520-T1. If you are directly connected to this site, this information is read from the current configuration.
SR500 Data VLAN Netmask	Subnet mask for the data VLAN on the SR520-T1. If you are directly connected to this site, this information is read from the current configuration.

Setting	Description
<b>Site Dial Pattern</b>	
Intersite Dialing Prefix	This read-only field displays the currently configured single-digit prefix for site-to-site dialing. This is a global configuration setting for all sites.
Digits per extension	Number of digits used for internal extensions (that is, extension length).
Site Identifier	<p>Enter a number from 1 to 5 that identifies this site. This is the Site ID used for intersite dialing.</p> <p>To dial this site, phone users at remote sites must use this format:</p> <p><i>Intersite Dialing Prefix + SiteID + Extension</i></p> <p>For example, if the prefix digit for intersite dialing is 7, and a user at site 1 wants to dial extension 307 at site 2, they must dial 72307 to reach that extension.</p>
Resulting Dial Pattern	This read-only field displays the site dialing pattern, based on the values currently configured for intersite dialing prefix, site identifier, and number of digits per extension.

## Configuring DDNS

DDNS is only required for sites that use DHCP to obtain a WAN IP address or sites that use PPPoE with IP address negotiation.

### Procedure

- STEP 1** Choose **Configure > Routing > Internet Connection** and open the Modify Internet Connection window.
- STEP 2** In the **HTTP DDNS** section of the Modify Internet Connection window, complete these settings:

Field	Description
<b>Provider</b>	Choose a DDNS provider from the pull-down menu. The account with the DDNS provider must be established outside of Configuration Assistant.
<b>Hostname</b>	<p>Unique hostname for this site, obtained from your DDNS provider. This is usually a fully qualified domain name (FQDN), for example, myhost.mydomain.net, but may be different for some DDNS services. The hostname must be registered.</p> <p>This field is not validated by Configuration Assistant. Make sure that you have entered the hostname exactly as specified by your DDNS provider.</p> <p>If you are configuring a multisite deployment, each site must have a unique DDNS hostname.</p>
<b>Username</b>	Account user name, obtained from your DDNS provider.
<b>Password/ Confirm Password</b>	<p>Account password, obtained from your DDNS provider.</p> <p>Re-enter the password for confirmation.</p>

- STEP 3** Click **OK**.
- STEP 4** Verify that the site configuration change triggered a DNS update with the DDNS provider.

## Configuring Quality of Service (QoS)

Quality of Services (QoS) settings for multisite deployments allow you to:

- Enable traffic shaping
- Specify the amount of upload bandwidth available for a site
- Specify the percentage of available WAN bandwidth to allocate for VoIP traffic when it is present on the network
- Use call admission control (CAC) to ensure that your call count can not exceed this bandwidth allocation to avoid degradation.

When QoS is enabled and configured:

- Priority is guaranteed for voice traffic, up to the percentage of available WAN bandwidth specified. When voice traffic exceeds this percentage, audio degradation will be observed for all VoIP calls.
- The remainder of the available WAN bandwidth is used for all other network traffic.
- If no voice traffic is present on the network, all of the available bandwidth can be used for data traffic.

### Important Guidelines

These important guidelines apply to configuring QoS:

- Configure QoS settings before configuring Maximum Calls so that Configuration Assistant can determine recommended settings for CAC.
- QoS configuration is optional, but strongly recommended. By default, it is disabled.
- QoS must be configured separately for each site. It is not part of the multisite configuration that is exported through the Multisite Manager.
- QoS is always configured on the device that is connected to the Internet:
  - If the UC500 is directly connected to the WAN, configure QoS on the UC500.
  - If the UC500 is behind an SR520-T1, configure QoS on the SR520-T1.

- Always specify the actual upstream bandwidth for the site, as determined by a reliable connection speed test or the Committed Information Rate (CIR) specified in the Service Level Agreement (SLA) for the Internet service provider.

If the CIR and connection speed test results are not available, specify an upstream bandwidth that is approximately 80% of the upstream bandwidth advertised by the Internet service provider.

Applying a bandwidth that is greater than experienced rates can cause audio degradation.

### Procedures

- 
- STEP 1** Navigate to **Configure > Routing > Internet Connection**.
- STEP 2** From the **Hostname** menu, select hostname of the device that is connected to the Internet (either the UC500 or an SR520-T1).
- STEP 3** Click on a connection to select it.
- STEP 4** Click **Modify**.
- STEP 5** In the Modify Internet Connection window, click the Traffic Shaping tab.
- STEP 6** Click the **Traffic Shaping** checkbox to enable traffic shaping.
- STEP 7** In the **Upstream Bandwidth [kbps]** field, enter the actual upstream bandwidth for the site, as determined by a connection speed test or the CIR (Committed Information Rate) specified in the SLA from the service provider. For example, if the upload speed is 1.8 Mbps, enter 1800 for the upstream bandwidth.
- Value values range from 384 kbps to 100000 kbps.
- If the results of a speed test are not available, enter a value in kbps that is 80% of the upstream bandwidth advertised by the ISP.
- STEP 8** In the **Media Reservation** field, use the slider bar to specify the proportion of available bandwidth to guarantee for voice media if it is present on the network. Valid values range from 1 to 95 percent (the remaining 5 percent covers signaling and other overhead). The default is 50%.
- STEP 9** Click **OK** or **Apply**.
- STEP 10** Save the configuration (**Configure > Save Configuration**).
-

---

## Exporting and Importing Sites

Once you have configured connection settings for each site, you export these settings to an XML file that can be imported onto each of the other sites.

### Exporting Sites

For each site, these settings are exported:

- Site name and index
- Intersite dialing prefix and number of digits in extensions
- Public IP address or hostname of the site
- IP address and subnet mask of the data LAN for the edge device on the network (SR500 or UC500)
- IP address and subnet mask of the UC500, if it is behind an SR500 secure router

**IMPORTANT** For security reasons, the **Pre-shared key** for site authentication is *not* included in the exported configuration file by default.

- If the pre-shared key is not exported in the configuration file, you must manually re-enter it for each site.
- You can choose to include the pre-shared key in the exported site data. The pre-shared key is exported as plain text, which is less secure.

Do not edit or delete any of the settings in this XML file. Any changes to the multisite configuration settings must be made through Configuration Assistant.

To export the multisite connection settings:

---

**STEP 1** Click **Export Multisite Configuration File**.

**STEP 2** Save the configuration file to the PC running Configuration Assistant.

---

## Importing Sites

To import multisite connection settings:

- 
- STEP 1** Connect the PC running Configuration Assistant directly to a LAN port on the UC500 for the site and make sure the PC has obtained an IP address from the UC500.
  - STEP 2** Launch Configuration Assistant and connect to the site.
  - STEP 3** Choose **Configure > Telephony > Site Management > Multisite Manager** from the feature bar to open the Multisite Manager.
  - STEP 4** If you have not previously configured multisite connections, click the **Import Multisite Connection Settings** button on the page that is initially displayed for the Multisite Manager.  
  
If you are re-importing settings, click **Import Site** from the main Multisite Manager window.
  - STEP 5** Browse to the location of the configuration file you exported previously and click **OK**.
  - STEP 6** Choose the site to import and click **OK**.
  - STEP 7** If the site settings do not match the current configuration on the site, Configuration Assistant detects the differences in the configuration and asks you whether you want to update the configuration.

If the data LAN IP address must be re-configured on the UC500 you will lose connectivity to Configuration Assistant and must re-connect using the new IP address.

---

## Modifying a Site After the Initial Configuration

You can modify site settings after the initial configuration, but if you do, you must:

- Export the new configuration.
- Import the new configuration onto all sites.



---

## Deleting a Site

To delete a single site from the a multisite configuration, follow these steps.

- 
- STEP 1** Launch Configuration Assistant and choose **Configure > Telephony > Site Management > Multisite Manager**.
  - STEP 2** In the Multisite Manager window, select the Multisite Configuration tab.
  - STEP 3** Locate the site you want to remove and click **Delete**.
  - STEP 4** Click **OK** to confirm the deletion.
  - STEP 5** Click **Apply** or **OK**.
- 

To delete all multisite configuration from the device to which you are connected, follow these steps:

- 
- STEP 1** Launch Configuration Assistant and choose **Configure > Telephony > Site Management > Multisite Manager**.
  - STEP 2** In the Multisite Manager window, select the Multisite Configuration tab.
  - STEP 3** Click **Delete Multisite Configuration**. This option is located in the lower right corner of the Multisite Manager window. The **Delete Multisite Configuration** option is only available if the Multisite Manager detects an existing configuration (that is, a configuration was successfully applied at least once).
  - STEP 4** Click **OK** when you are asked whether you want to remove all multisite configuration.

When you click **OK**, all existing multisite configuration is completely removed from the device. The Multisite Manager window refreshes to display the default initial page without any configuration settings.

---

## Multisite Status Monitoring

To monitor multisite VPN tunnel connections and view diagnostic information:

- Choose **Monitor > Multisite Status** from the toolbar, or
- Click the Multisite Status tab in the Multisite Manager.

The Multisite Status monitor has these areas:

- **VPN Tunnel Status Summary**
- **VPN Tunnel Status Detail**

### VPN Tunnel Status Summary

The VPN Tunnel Status Summary section displays the status of each VPN tunnel connection among all sites in the deployment. If the multisite configuration has not yet been imported and applied to a site, the text “Site Configuration Not Yet Applied” is displayed.

Click **Connect to All Sites** to manually bring up the VPN tunnels among all the sites.

### VPN Tunnel Status Detail

The **VPN Tunnel Status Detail** area displays the output for the **show crypto session detail** Cisco IOS command. This command lists all active Virtual Private Network (VPN) sessions and the IKE (Internet Key Exchange) and IPsec SAs (security associations) for each VPN session.

Note these lines in the example output:

- **Session status.** This displays the tunnel status. When the tunnel is coming up, this status is DOWN-NEGOTIATING. When the tunnel is up, the status can be UP-ACTIVE, UP-NO-IKE, or UP-IDLE. If the session status is DOWN, the tunnel does not exist.
- **IPSEC FLOW.** A snapshot of information about the IPsec-protected traffic flow. The IP addresses correspond to the data VLAN IP addresses and subnet masks configured for the UC 500 and SR 500.

Crypto session current status

```
Code: C - IKE Configuration mode, D - Dead Peer Detection
K - Keepalives, N - NAT-traversal, T - cTCP encapsulation
X - IKE Extended Authentication, F - IKE Fragmentation
```

```
Interface: Serial11/0:1
```

```
--> Session status: UP-NO-IKE
```

```
Peer: 10.130.2.2 port 500 fvrf: (none) ivrf: (none)
```

```
Desc: (none)
```

```
Phase1_id: (none)
```

```
--> IPSEC FLOW: permit ip 192.168.30.0/255.255.255.0 192.168.20.0/
255.255.255.0
```

```
Active SAs: 2, origin: crypto map
```

```
Inbound: #pkts dec'ed 335 drop 0 life (KB/Sec) 4429573/683
```

```
Outbound: #pkts enc'ed 335 drop 0 life (KB/Sec) 4429573/683
```

```

--> IPSEC FLOW: permit ip 192.168.75.0/255.255.255.0 192.168.20.0/
255.255.255.0
    Active SAs: 0, origin: crypto map
    Inbound:  #pkts dec'ed 0 drop 0 life (KB/Sec) 0/0
    Outbound: #pkts enc'ed 0 drop 0 life (KB/Sec) 0/0

Interface: Serial1/0:1
Session status: UP-NO-IKE
Peer: 10.130.1.2 port 500 fvrf: (none) ivrf: (none)
    Desc: (none)
    Phase1_id: (none)
--> IPSEC FLOW: permit ip 192.168.75.0/255.255.255.0 192.168.10.0/
255.255.255.0
    Active SAs: 0, origin: crypto map
    Inbound:  #pkts dec'ed 0 drop 0 life (KB/Sec) 0/0
    Outbound: #pkts enc'ed 0 drop 1 life (KB/Sec) 0/0
--> IPSEC FLOW: permit ip 192.168.30.0/255.255.255.0 192.168.10.0/
255.255.255.0
    Active SAs: 2, origin: crypto map
    Inbound:  #pkts dec'ed 725 drop 0 life (KB/Sec) 4492717/470
    Outbound: #pkts enc'ed 707 drop 1 life (KB/Sec) 4492717/470
. . .

```

## Voice Features Supported Across Multiple Sites

This table lists common voice features and indicates which are supported among sites in a multisite configuration.

Voice Feature	Supported Among Multiple Sites
Basic site-to-site calls with abbreviated dialing	Yes
Transfer calls between sites	Yes
Conference calls between sites	Yes
Paging and Call Park across sites	No
Forward voice mails between sites	No
Auto Attendant	Partial  The Auto Attendant can transfer calls to other site extensions using abbreviated site dialing.

Voice Feature	Supported Among Multiple Sites
Fax between sites	Yes
Extension mobility across sites	No
Hunt groups configured across sites	No* Call Blast groups support “Other” digit entry, which allows Blast Groups to be configured across sites.
Shared directory across sites	No

## Maximum Calls (Call Admission Control)

To access call admission control settings, choose **Configure > Telephony > Site Management > Maximum Calls**.

### Overview

Call admission control (CAC) limits the number of simultaneous calls over the WAN. When call admission control is enabled and configured, it is applied to all calls that traverse the WAN. This includes intersite calls in a multisite deployment and SIP calls.

Configure Traffic Shaping/QoS settings before configuring Maximum Calls so that Configuration Assistant can determine recommended settings for CAC based on these settings.

When you change this setting, the **Maximum Number of Calls** setting configured in the SIP Trunk window is also updated (**Configure > Telephony > Ports and Trunks > SIP Trunks**). See [SIP Trunks, page 296](#).

## Procedures

To configure Call Admission Control, follow these steps.

- 
- STEP 1** Choose **Configure > Telephony > Site Management > Maximum Calls** from the feature bar to open the Maximum Calls window.
- STEP 2** Choose a device from the Hostname field.
- STEP 3** In the Maximum Calls field, enter the maximum number of simultaneous calls to allow.

If you enter a value of zero (0), call admission control is disabled.

If QoS is enabled and configured for the site:

- The **Current Traffic Shaping** section displays read-only information about the Traffic Shaping settings currently configured on the system (upstream bandwidth in kbps and percentage of WAN bandwidth guaranteed for VoIP calls).
- The **Maximum Call Ranges** section displays Recommended, Sensitive, and Degraded ranges for the Maximum Calls setting, based on the currently configured QoS settings.

If QoS is not configured, choose **Configure > Routing > Internet Connection** from the feature bar, select the WAN connection, click **Modify**, and select the Traffic Shaping tab.

**CAUTION** If you choose a number in the Sensitive or Degraded range for the Maximum Calls setting, this can result in poor voice quality for all VoIP calls, including intersite calls) if available bandwidth is exceeded.

- STEP 4** Enter the maximum number of calls to allow for this site.
- STEP 5** Click **OK**.
-



# Applications

Cisco Configuration Assistant provides support for enabling and configuring Cisco SBCS Smart Applications and other third-party applications for UC500 platforms.

For some applications, application-specific setup options must be configured to enable and use the application.

These topics provide information about enabling and configuring settings for Cisco SBCS applications:

- **General Settings**
- **Smart Applications Manager**
- **Application-Specific Configuration**

For information on Cisco SBCS third-party applications, go to this URL on the Cisco Small Business Support Community:

<https://supportforums.cisco.com/docs/DOC-9780/>

## General Settings

Some applications, such as Cisco WebEx PhoneConnect or other third-party SBCS applications, require general system settings to be configured in order to run. To access general settings for applications, choose **Applications > General Settings** from the feature bar.

General settings that can be configured are described in these sections:

- **Authentication URL**
- **Services Menu Access**
- **Call Accounting**
- **HTTPS Authentication**

For more detailed information about general settings for applications, refer to the documentation for the application you are configuring.

## Authentication URL

This window appears when you choose **Applications > General Settings > Authentication URL** from the feature bar.

This setting specifies the CME authentication URL required for a Cisco SBCS Smart Application or third-party application.

Here are some example authentication URLs:

- VoiceView Express

`http://10.110.1/voiceview/authentication/authenticate.do`

- WebEx PhoneConnect

`http://10.110.2/CCMCIP/authenticate.asp.`

Only one authentication URL can be in use at a time. To configure a different application and authentication URL, you must first disable the application that is using this setting. For example, you must disable Webex PhoneConnect if you need to configure an authentication URL to integrate with a third-party application.

**NOTE** Some authentication URLs are compatible with more than one Cisco SBCS application. For example, the VoiceView Express authentication URL is also compatible with the TimeCardView authentication URL. The WebEx PhoneConnect application URL is compatible with both VoiceView Express and TimeCardView, and these applications can be simultaneously enabled if there are enough resources to run them.

When you first access the Authentication URL window, the VoiceView Express authentication URL is displayed. This is because the default setting for VoiceView Express is **Enabled**. Configuration Assistant automatically sets the application authentication URL and CME service URL for VoiceView Express when the voice system is initialized. To enable or disable VoiceView Express, choose **Configure > Telephony > Users and Extensions > Voicemail** and select the Setup tab.

Not all applications require an authentication URL. Refer to the documentation for the application you are configuring to determine the URL to enter here. Some applications automatically configure this URL when they are enabled.

Click **OK** or **Apply** when you have entered the authentication URL.



## Services Menu Access

This window appears when you choose **Applications > General Settings > Services Menu Access** from the feature bar.

- **Overview**
- **Adding a CME Service URL**
- **Modifying or Deleting a CME Service URL**

### Overview

From the Services Menu Access window, define the menu item name, CME Service URL, and order of menu items on IP phones for configurable service URLs. These are used by applications such as WebEx PhoneConnect, TimeCardView, and other third-party applications. The menu items defined here is displayed when the user presses the **services** button on their IP phone.

Up to 8 Service URLs can be configured.

Use the **Up** and **Down** arrow buttons to change the order in which they are displayed on the **services** menu on IP phones.

Only the order of configurable CME service URLs can be modified. On the Cisco IP phone **services** menu, the CME Service URL item always appears first, followed by configurable CME service URLs, Extension Mobility, and My Phone Apps items.

**IMPORTANT** Refer to the documentation for the application you are configuring for the specific URL to enter.

- Some applications, such as WebEx PhoneConnect and VoiceView Express automatically configure this URL for you.
- If a service URL is automatically configured by an application when it is enabled, the service URL is automatically deleted from the list when the application is disabled. You cannot modify or delete service URLs that are configured by these applications.

### Adding a CME Service URL

To add a new CME Service URL, follow these steps.

- 
- STEP 1** Click **Add** to open a new row in the table for editing.
- STEP 2** Configure the service name and URL.

Setting	Description
<b>Menu Name</b>	CME service menu name to display on the Services menu on Cisco IP Phones. The menu name can have up to 15 characters and must not contain spaces or special characters.
<b>URL</b>	CME service URL, for example: http://10.1.10.1/WebExPhone/MainMenu

- STEP 3** If multiple CME service URLs are listed, use the **Up** and **Down** arrow buttons to reorder the menu items.
- STEP 4** Click **OK**.
- 

### Modifying or Deleting a CME Service URL

You cannot modify or delete default service URLs that are automatically configured by SBCS applications such as VoiceView Express, TimeCardView or WebEx PhoneConnect. You can, however, disable these applications to remove the service URLs.

User-configured service URLs can be deleted or modified as needed.

- To modify a user-configured service URL, click in the Menu Name or URL column for the row that contains the URL, make your edits, and click **OK** or **Apply**.
- To delete a user-configured service URL, select the URL from the list and click **Delete**.

## Call Accounting

The Call Accounting window appears when you choose **Applications > General Settings > Call Accounting** from the feature bar.

### Overview

From this window you can enable or disable Call Detail Record (CDR) collection and specify the location on an external TFTP or FTP server where the CDRs are stored, as well as a backup location on the UC500 flash. These settings are used in conjunction with call accounting applications that capture CDRs and store them to an external FTP server.

Backup CDR files are stored in the flash:cdr/ directory on the UC500. Click **Copy CDR to File** to manually write CDRs to the specified backup file on the flash.

For more information, see the documentation for the call accounting application you are configuring.

### Procedures

Configure general settings for Call Accounting applications as described in this table. Click **OK** or **Apply** when you are finished.

Setting	Description
<b>Call Accounting Server</b>	
<b>FTP URL</b>	Sets the primary location for storing the CDRs generated for file accounting.  Specify a path/filename for the location of the file on an FTP server.  For example: ftpserver01/cdrs
<b>Username</b>	Username for FTP server authentication
<b>Password</b>	Password for FTP server authentication

Setting	Description
<b>Flash Backup</b>	
<b>Flash Backup Filename</b>	<p>Base filename to use for CDR backups in the flash:\cdr\ directory on the UC500, for example, <code>cdr_backups</code>. The filename can contain up to 15 characters. Spaces and special characters are not permitted.</p> <p>The CDR backup file is given a unique name when it is created. The router hostname and time stamp are appended to the filename in the format <code>&lt;filename&gt;.&lt;hostname&gt;.&lt;timestamp&gt;</code>.</p> <p>For example, if the <b>Flash Backup Filename</b> is <code>cdr_backups</code>, the path and filenames are formatted as shown below:</p> <pre>flash:/cdr/ cdr_backups.UC520.07_25_2009_18_15_10.346</pre>
<b>Copy CDR to File</b>	<p>Click <b>Copy CDR to File</b> to manually write pending CDR information to the CDR backup file on the UC500 flash.</p> <p>When you click <b>Copy CDR to File</b>, a new CDR backup file is created on the flash.</p>

## HTTPS Authentication

This window appears when you choose **Applications > General Settings > HTTPS Authentication** from the feature bar.

Some applications, such as Cisco WebEx PhoneConnect, require you to enable HTTPS communication and provide a username and password for authentication.

For more information refer to the documentation for the application you are configuring.

Configure **HTTPS Authentication** settings as described in this table. Click **OK** or **Apply** when you are finished.

Setting	Description
<b>Enable HTTPS Communication</b>	When enabled (checked), this setting creates the HTTPS private certificate used to connect to the PhoneConnect Web Services API.  For WebEx PhoneConnect, this option must be checked.
<b>Name</b>	Username for HTTPS authentication. The username can contain up to 15 characters. Spaces and special characters are not permitted. By default this setting is blank. Required for WebEx PhoneConnect.
<b>Password</b>	Password for HTTPS authentication. The password can contain up to 15 characters. Spaces and special characters are not permitted. By default this setting is blank. Required for WebEx PhoneConnect.

## Smart Applications Manager

To access options for enabling and disabling Smart Applications, choose **Applications > Smart Applications Manager** from the feature bar.

### Overview

From the Smart Applications Manager, you can enable, disable, and configure Cisco SBCS Smart Applications. These applications run on the CUE module of the UC500 platform. You can also view total resources available, resources required for each application, and current usage by each application. Applications that can be enabled from this window include:

- Unified Messaging
- Cisco WebEx PhoneConnect
- Cisco TimeCardView

System resources in use by an application are indicated by displaying a number of credits. A total of 100 credits are available to the system. The number of credits required for each application is the minimum number of credits needed to run the application, based on CPU, memory, and disk utilization. Some applications such as Video Telephony and Live Record do not require any credits to run. Configuration Assistant displays an error if you attempt to enable an application without the required number of resources.

To enable or disable an application:

- 
- STEP 1** In the Applications list on the left, click on the application you wish to enable. A brief description of the application is displayed,
- STEP 2** Click **Configure** to access options for enabling and configuring the application. See these sections for information about configuring Cisco SBCS Smart Applications:
- [Unified Messaging \(IMAP\), page 479](#)
  - [Cisco WebEx PhoneConnect, page 480](#)
  - [TimeCardView, page 493.](#)
- STEP 3** Click **OK** or **Apply** when you are finished configuring application settings.
- 

## Application-Specific Configuration

The topics in this section provide an overview of each application along with instructions for configuration application-specific setup options.

- [Unified Messaging \(IMAP\)](#)
- [Video Telephony](#)
- [Cisco WebEx PhoneConnect](#)
- [TimeCardView](#)

## Unified Messaging (IMAP)

The Unified Messaging Configuration window appears when you select Unified Messaging from the Applications list in the Smart Applications Manager window and click **Configure**.

### Overview

Unified Messaging allows voice mail subscribers to have an integrated view of their emails and voice mail messages from a single email client using IMAP. Subscribers can delete voice mail messages or mark them as read or unread in a manner similar to email messages. The voice mail messages are downloaded as attachments to email messages. Subscribers can access voice mail messages over the network or download them selectively. The default setting for this application is disabled.

### Procedures

#### Enabling or Disabling Unified Messaging

To enable or disable Unified Messaging, click the **Enable Unified Messaging** checkbox, then click **OK** to return to the Smart Applications Manager window.

#### Configuring the IMAP Client

In order for a user to take advantage of this feature, their email client (for example, Microsoft Outlook) must be configured for IMAP. When configuring the client for IMAP:

- Use the Cisco Unity Express (CUE) module IP address (10.1.10.1) for the IMAP server IP address.
- The username and password configured on the IMAP client for authentication must match the username and password of the phone user as it is configured in Cisco Configuration Assistant.

## Video Telephony

The Cisco Unified Video Advantage (CUVA) solution in SBCS allows users to make desktop-to-desktop video telephony calls between Cisco IP phones that are video enabled.

Video Telephony is enabled by default. To disable this open, uncheck the **Enable Video Telephony** option and click **OK**.

You can choose whether video calls are allowed on specific phones by enabling or disabling the **Allow video calls** option on each phone. See [Allow Video Calls, page 306](#).

## Cisco WebEx PhoneConnect

WebEx PhoneConnect is designed for customers who want fast, simple access to WebEx meetings from their IP phone without the need for a desktop PC. WebEx PhoneConnect automates this entire process so that IP phone users can join the audio portion of a WebEx conference by pressing a single softkey on their IP phone. This section covers these topics:

- [About Cisco WebEx PhoneConnect](#)
- [SBCS Platform Requirements](#)
- [Related Documentation](#)
- [WebEx Site Administrator Account Information](#)
- [Procedures](#)

### About Cisco WebEx PhoneConnect

Once a WebEx user is associated with an IP phone through WebEx PhoneConnect, a simple meeting browser application is installed on their Cisco IP phone display that allows the IP phone user to:

- List WebEx meetings they are hosting
- List WebEx meetings to which they are invited by other IP phone users in their company (users must share same UC500 router)
- Receive audio and visual alerts on their IP phone when it is time to join a meeting
- Control how far in advance of the meeting they want to receive alerts
- Press a single softkey to join a meeting

WebEx users with access to a WebEx Connect client from a desktop PC can use Click-to-Call with their IP phone to automatically dial someone on their WebEx Connect Buddy List.



## SBCS Platform Requirements

Component	Version
Cisco Configuration Assistant (CCA)	2.0 and later
UC500 Software Pack	7.0(3) or later
Cisco IOS	12.4(20)T2 or later Cisco Unified Communications Manager Express (CME) 7.0 or later
Cisco Unity Express (CUE)	CUE 7.0 or later
Supported Cisco IP Phones	Cisco Unified IP Phone Models 794x, 796x, and 797x Cisco Unified Wireless Phones Models 7921 and 7925 Cisco Unified IP Phone 7937 Cisco Unified IP Phone 524G Cisco Unified IP Phone 521G Cisco SPA525G and SPA525G2 IP Phones Cisco IP Communicator (CIPC) softphone client

### Related Documentation

For detailed information on configuring and administering WebEx PhoneConnect, see the *Cisco WebEx PhoneConnect Administration Guide*.

End-user information and instructions are documented in the *Cisco WebEx PhoneConnect Quick Reference*.

## WebEx Site Administrator Account Information

Before you can enable and configure the WebEx PhoneConnect application, your customer must have or obtain a WebEx small business account from WebEx with an administrative user.

- Your customer must provide you with their WebEx service site account information (administrative user ID and password, site ID, and site URL).

CCA uses this information to connect to the customer's WebEx service site and associate the customer's WebEx user accounts with the WebEx PhoneConnect application.

- Make sure that you know the password policy being used for the site.

When a WebEx site is set up, the site administrator can specify a password policy. The policy defines user password requirements such as the minimum and maximum number of characters, password strength, characters that cannot appear in passwords, and so on. All WebEx user passwords must conform to this policy.

## Before You Begin

Before configuring WebEx PhoneConnect, make sure that:

- Phones and user extensions are configured on the system (**Configure > Telephony > Users and Extensions > Users and Phones > User Extensions** tab).
- Dial plan and voice trunks have been configured and inbound/outbound calls are working correctly.
- DNS server IP address is configured. The Internet Service Provider DNS server IP address is used by WebEx PhoneConnect to locate the webex.com server.
- NTP server is configured (optional; recommended for synchronization of meeting times and alerts).

## Procedures

Read this section for an overview of WebEx PhoneConnect configuration steps. For more detailed information, see the *Cisco WebEx PhoneConnect Administration Guide*, available on Cisco.com.

To configure Cisco WebEx PhoneConnect, follow these steps.

- 
- STEP 1** Launch Cisco Configuration Assistant and connect to the Cisco UC500.
- STEP 2** Choose **Applications > General Settings > Authentication URL** from the feature bar. In the Authentication URL window, configure these settings:
- Verify that `http://10.1.10.2/CCMCIP/authenticate.asp` is being used for the URL. If not, modify this setting so that it is.
  - Click **OK**.
- STEP 3** Choose **Applications > General Settings > HTTPS Authentication** from the feature bar.
- STEP 4** In the HTTPS Authentication window, configure these settings:
- Check **Enable HTTPS Communication** (required).
  - Enter a username and password for HTTPS authentication (required).
  - Click **OK**.
- CME Service URL settings for WebEx PhoneConnect are filled in automatically after the PhoneConnect application is enabled.
- STEP 5** Navigate to **Applications > Smart Applications Manager**.
- STEP 6** Click **WebEx Phone Connect** to select the application, then click **Configure**. The PhoneConnect Configuration Login window appears.
- STEP 7** In the PhoneConnect Configuration Login window, enter the customer's WebEx administrator username, password, site ID, and Site URL and click **OK**. See [PhoneConnect Configuration Login Window, page 484](#).
- Once the site login credentials are verified, the PhoneConnect Application Main window appears and displays information for the WebEx site.
- STEP 8** In the PhoneConnect Application Main window, click the **Enable** checkbox at the top of the window and configure site settings. See [PhoneConnect Application Main Window, page 484](#).

- STEP 9** Add users and enable WebEx PhoneConnect on their Cisco IP phones as described in the Cisco *WebEx Phone Connect Administration Guide*. See [PhoneConnect Application Main Window, page 484](#).
- STEP 10** Click **OK** to apply the site settings and close the PhoneConnect Application Main window.
- STEP 11** In the Smart Applications Manager window, click **OK**.

See [PhoneConnect Advanced Site Configuration, page 490](#), for information about additional settings that may need to be configured.

### PhoneConnect Configuration Login Window

To configure PhoneConnect, you must first log in with the WebEx site administrator account credentials, as described below.

Setting	Description
<b>UserID</b>	WebEx site administrator user ID. Also referred to as a WebEx ID.
<b>Password</b>	WebEx site administrator password
<b>SiteID</b>	WebEx site ID number (text characters are not accepted in this field).
<b>SiteName</b>	WebEx site name (the first string in the WebEx site URL). For example, if the WebEx site URL is http://acme.webex.com, enter acme for the site name.

Click **OK** when you are finished entering login credentials.

### PhoneConnect Application Main Window

This window appears when you have successfully logged with the WebEx site administrator credentials after clicking **Setup Options** for WebEx PhoneConnect in the Smart Applications Manager window.

Configure the settings in the PhoneConnect Application Main window as described below. Click **OK** or **Apply** when you are finished making changes.

Setting	Description
<b>Customer Administrator Information</b>	
Contact information for the WebEx site administrator.	
First Name	WebEx site administrator first name
Last Name	WebEx site administrator last name
Email	WebEx site administrator email address
Company	WebEx site administrator company name
Phone	WebEx site administrator phone number
<b>WebEx Users Information</b>	
UserID	<p>Required. This is the WebEx account user ID that the user enters when logging in to the WebEx service site to schedule, attend, and browse meetings.</p> <p>Recommended format: <i>&lt;phone user ID&gt;@&lt;admindomain&gt;.com</i></p> <p>All new WebEx users created through PhoneConnect must use the email address format for their user ID. WebEx user accounts created before PhoneConnect was enabled can continue to use the existing user ID format.</p> <p>If all of your customer's users share the same email domain, it is recommended that you add your customer's email domain after the phone user ID, and use this as the User ID, for example, jsmith@acme.com.</p>

Setting	Description
Password	<p>Required. This is the password the user enters when logging in to the WebEx service site to host, attend, or browse meetings.</p> <p>When a WebEx site is set up, the site administrator can specify a password policy. The policy defines criteria for user passwords such number of characters, passwords that cannot be used, and so on. All user passwords must conform to the password policy for your customer's WebEx service site.</p> <p>Be sure to notify users if you change their password.</p>
Email	<p>Required. This is the email address to which WebEx meeting invitations and WebEx notices are sent.</p> <p>If the user does not have an email address (for example, the user is a conference room, this format is recommended:</p> <p><i>&lt;phone user ID&gt;@&lt;admindomain&gt;.com</i></p> <p>where the <i>&lt;phone user ID&gt;</i> is the phone user ID found in the Associated Phone User field.</p>
Last Name	Required. WebEx account user first name.
First Name	Required. WebEx account user last name.
Associated Phone	Read only. Displays the current phone user ID associated with this WebEx account. If no phone user ID is associated with the WebEx PhoneConnect user, --None-- is shown.

Setting	Description
Select Phone	<p>Click <b>Select Phone</b> to open a dialog for choosing a phone user to associate with this WebEx user account and enabling the PhoneConnect application on their phone. See <a href="#">Select Phone, page 489</a>.</p> <p>If the user has an existing WebEx account and has a phone configured on the system, but does not have PhoneConnect enabled on their phone you can use Select Phone to enable the PhoneConnect application on their phone.</p> <p><b>IMPORTANT:</b> If you are editing an existing WebEx user account in order to enable PhoneConnect, you must assign the WebEx user a new password (this is required so that PhoneConnect can authenticate the phone user). Be sure to notify the user of their new WebEx account password.</p>
Add	<p>Insert a new row in the WebEx users list for adding a new WebEx user.</p>
Delete	<p>Delete the selected WebEx user.</p> <p>The user is moved to the de-activated state on the WebEx service site. Once a user account is deleted, the user no longer has access to WebEx or WebEx PhoneConnect. The user will no longer receive meeting invitations or alerts, and will not be able to attend or host WebEx meetings from their company's WebEx service site.</p> <p>To reinstate a user after they have been deleted (for example, if a user leaves the company but then returns), you can use their old UserID and other account information. However, a new password must be created, as WebEx can be configured to reject a password that is the same as any of the last three passwords previously registered with WebEx.</p>

Setting	Description
Copy From Device	<p><b>Copy From Device</b> is an alternative method for adding WebEx users.</p> <p>Click <b>Copy from Device</b> to open a dialog for choosing existing phone users to associate with this WebEx account. The first name, last name, password, and phone for each selected phone user are copied into the WebEx users list. The WebEx UserID and email address fields are left blank. See <a href="#">Copy From Device, page 490</a>.</p>
<b>Customer Site Configuration Information</b>	
Install Language Files	<p>Add a new localized language for your IP phone users' WebEx PhoneConnect meeting browser and alerts.</p> <p>Only the WebEx PhoneConnect IP phone screens are affected by this procedure. See <a href="#">Install Language File for WebEx PhoneConnect, page 492</a>.</p>
Advanced Configuration	<p>Access advanced configuration settings. See <a href="#">PhoneConnect Advanced Site Configuration, page 490</a>.</p>
<b>Meeting Call-In Configuration</b>	
Call-In Preference	<p>Use a Toll-Free or Toll number for WebEx meeting call-in. The default is Toll-Free.</p>
Dial-out Prefix	<p>Digit that callers dial to get an outside line. The default value is the access code for external dialing defined on the system. You can edit this setting.</p>
<b>Call-In Number Conversion - Toll Number or Free Number</b>	
<p>Depending on where your customer is dialing from, how their outgoing dial plan is set up, and how the WebEx call-in number is formatted, you might need to use these settings to remove or replace initial dialing prefixes such as country codes, area or city codes, or code for international dialing.</p>	
WebEx Provided Number	<p>Read-only. Telephone number provided by WebEx for this WebEx site.</p>



Setting	Description
Remove Num. of Digits from the Front	<p>Number of digits to remove from the beginning of WebEx-provided number. This field is required and cannot be left blank. The default value is zero (0).</p> <p>Enter the number of digits that must be removed or replaced as required to match the dial-out number.</p>
Add Digits to the Front	<p>Digits to add to the beginning of the WebEx-provided call-in number. This field can contain up to 20 digits. The default value is None (blank).</p> <p>Enter digits to be added to the front of the number, for example, an area code that differs from the one in the WebEx-provided number. You do not need to add the Dial-Out Prefix (access code) here. The Dial Out Prefix is automatically added to the front of the number.</p>
Resulting Number of Digits to Dial	<p>Dial-out number after adding and removing digits and pre-pending the dial-out prefix. The number displayed is read-only and is generated using the Dial-out Prefix and the values entered in the Dial-Out Prefix and Remove/Add Digits fields.</p> <p>Verify that the number matches what users manually dial to reach the WebEx service.</p>

### Select Phone

This window appears when you click **Select Phone** in the WebEx users list on the WebEx PhoneConnect Application Main window.

**STEP 1** In the Select Phone window, select a phone from the list that you wish to associate with this WebEx PhoneConnect user.

Only phones that are not currently enabled for PhoneConnect are listed.

**STEP 2** Click **OK** to return to the WebEx PhoneConnect Application Main window.

## Copy From Device

This window appears when you click **Copy From Device** in the WebEx PhoneConnect Application Main window.

The **Copy From Device** option provides a convenient way to add WebEx accounts and enable PhoneConnect for multiple existing phone users. When you use **Copy From Device**, previously provisioned values are automatically copied into the appropriate WebEx user account fields.

To use **Copy From Device**, follow these steps.

- 
- STEP 1** Select one or more phone users for which you want to add WebEx accounts. Only phones that are not associated with a WebEx user account are listed.
  - STEP 2** Click **Select All** or use the CTRL-click and SHIFT-click keyboard shortcuts to select multiple users.
  - STEP 3** Click **Add** to move phone users to the list of selected users.
  - STEP 4** Click **OK**.

The User ID, first name, last name, email address, and associated phone for each existing phone user are copied into the WebEx users list in the WebEx PhoneConnect Application Main window. The password is left blank.

- STEP 5** In the PhoneConnect Application Main window, you must locate the users you just added, and complete the Password field.

As soon as an IP phone is associated with a WebEx user, it has full WebEx PhoneConnect functionality. The IP phone does not need to be restarted. Open menus on phones might need to be closed to see the changes.

---

## PhoneConnect Advanced Site Configuration

To access advanced configuration settings for WebEx PhoneConnect, click **Advanced Site Configuration** from the WebEx PhoneConnect Application Main window.

In most cases, you can use the default settings. You only need to make changes if you are experiencing problems with WebEx PhoneConnect.

Configure advanced site settings for the WebEx PhoneConnect application as described below. Click **Apply** or **OK** when you are done configuring site settings.

Setting	Description
<b>Application Timing Configuration</b>	
Check for new meetings (minutes)	<p>How often to poll WebEx for new meetings. The default value is 4 minutes.</p> <p>Reducing frequency below 4 minutes can adversely affect Cisco Unity Express (CUE) performance.</p>
Delay before providing the meeting ID (seconds)	<p>Number of seconds the system waits after the Call button on the IP phone is pressed before auto-entering the meeting ID. The default setting of 10 seconds is based on FXO/BRI/PRI trunk connectivity.</p> <p>This value can be set to 7 seconds if SIP trunks are used. You may need to increase the interval if calling internationally. There are no known performance impacts.</p>
Delay between digits (milliseconds)	<p>The speed with which digits are dialed when auto-entering a meeting ID. The default value is 200 ms.</p> <p>You may need to increase interval depending on where calling (for example, when calling internationally). There are no known performance impacts.</p>
Clear WebEx Site Data	<p>Click <b>Clear WebEx Site Data</b> to remove all WebEx site data from the UC500.</p> <p>This does not affect the WebEx service site or account information; it only removes the WebEx PhoneConnect application settings and site data stored on the Cisco UC500. The PhoneConnect application is removed from all users phones.</p> <p>This may be needed, for example, in situations where the wrong site data is imported onto the UC500, the WebEx site changes, the WebEx site is no longer active, or where demonstration site data must be removed from the system.</p>

## Install Language File for WebEx PhoneConnect

To install a new localized language file for WebEx PhoneConnect, click **Install Language File** from the WebEx PhoneConnect Application Main window.

WebEx PhoneConnect supports localization of IP phone GUI displays for the WebEx PhoneConnect meeting browser and for alerts. Between releases, Cisco adds support for additional languages as they become available. You can update the WebEx PhoneConnect application with a new language using the Install Language File option. Once the new language file is installed and the new language is selected in Configuration Assistant, all of the WebEx PhoneConnect IP phone screen menus will use the new language.

Before you begin, you must first localize the UC500 to the desired region and language (**Configure > Telephony > System > Region**), then download the corresponding WebEx localization file for the new language.

**NOTE** WebEx PhoneConnect does not support the UC500 phone override localization feature. WebEx PhoneConnect only displays the default language selected.

Follow these steps to add a new language for WebEx PhoneConnect.

- 
- STEP 1** In the **File to install** field, browse to the language file you want to install and click **Open**.
  - STEP 2** Click **Install**. The new language file is moved to the Installed Language File(s) list. You can overwrite an existing language file, but you cannot delete an existing language file.
  - STEP 3** Click **OK** to deploy the language file to the CME localization directory and return to the PhoneConnect Application Main window.

You are prompted to restart the CUE module on the UC500.

- STEP 4** To restart the CUE module on the UC500, open the Topology view, right-click on the UC500, and select the **Restart CUE** option from the menu.

The CUE restart can take from 10 to 15 minutes. During that time, voice mail, Auto Attendant, and other applications that require a connection to CUE will be unavailable.

---

## TimeCardView

This window appears when you select TimeCardView in the Applications list in the Smart Applications Manager window and click **Configure**.

**IMPORTANT** This section only covers TimeCardView setup and payroll server settings that can be managed through Configuration Assistant. For more information, see the documentation listed under [TimeCardView Documentation, page 494](#).

TimeCardView is a time and attendance system for Cisco IP phone users connected to Cisco SBCS platforms.

- [Overview](#)
- [TimeCardView Documentation](#)
- [SBCS Platform Requirements](#)
- [TimeCard Configuration](#)
- [Payroll Server Configuration](#)

### Overview

TimeCardView automatically tracks employees' working hours and enables supervisors to view employees' real time status. It provides for online review and approval of timesheets and it can generate the reports supervisors and payroll specialists need via the Historical Reporting Client and export them to the .csv and .xls file formats.

TimeCardView enables employees to use a Cisco Unified IP phone connected to Cisco Unity Express to automatically track the hours worked (start shift, end shift, lunch, and breaks) and review hours for the shift, the day, the week, or the month.

Supervisors and payroll specialists use TimeCardView to set limits on the time employees can spend in any state, view their current shift status, and review and approve their timesheets.

Optionally, TimeCardView can be set up to interface with back-end accounting software such as Intuit's QuickBooks so that timesheet data can be seamlessly transferred to the accounting system.

**NOTE** TimeCardView is not supported on all Cisco IP Phone models. The maximum number of TimeCardView users is restricted to the maximum number of users that your Cisco SBCS platform supports.

## TimeCardView Documentation

These TimeCardView guides are available on Cisco.com:

- For detailed information about configuring the TimeCardView application and managing users, see the *TimeCardView 7.0 GUI Guide*.
- End-user information and instructions are documented in the *TimeCardView 7.0 for Users Quick Start Guide*.

## SBCS Platform Requirements

- Cisco Configuration Assistant (CCA) 2.0 or later
- UC500 Software Pack 7.0(3) or later
  - Cisco IOS 12.4(20)T2 or later
  - Cisco Unified Communications Manager Express (CME) 7.0 or later
  - Cisco Unity Express (CUE) CUE 7.0.1 or later

## TimeCard Configuration

On the Time Card Configuration tab, configure TimeCardView application administration settings as described below. Click **OK** or **Apply** when you are finished making changes.

Setting	Description
Maximum Sessions	Maximum number of TimeCardView sessions, either 2 or 8, depending on the platform.  The default is 2.
Notification Emails	RFC-2822-compliant email address to use for application notification emails, for example, name@company.com.
Supervisor IP Phone Application Timeout (60 - 600 seconds)	Amount of time, in seconds, that elapses before the system automatically logs out the specified supervisor.
Employee IP Phone Application Timeout (60 - 600 seconds)	Amount of time that elapses before the system automatically logs out the specified employee

Setting	Description
Maximum Daily Work Duration (1 - 1440 minutes)	Number of minutes employees can remain in the work state.
Maximum Daily Overtime Duration (0 - 1440 minutes)	Maximum number of overtime minutes per day employees can work. If you change the default, do not forget to limit the number of regular working hours, otherwise employees cannot accrue overtime.  The default is 0.
Maximum Daily In-Shift Work Duration (1 - 1440 minutes)	Number of minutes employees can remain in the work state.  The default is 1440.
Maximum Daily Break Work Duration (1 - 1440 minutes)	Number of minutes employees can remain in the break state.  The default is 1440.
Maximum Daily In-Shift Lunch Duration (1 - 1440 minutes)	Number of minutes employees can remain in the lunch state. The default is 1440.
Work Starts On	Starting day of the work week. The default is Monday.

### Payroll Server Configuration

On the Payroll Server Configuration tab, complete the fields as described below if you wish to integrate TimeCardView with Intuit Quick Books. Click **OK** when you are finished configuring server settings.

Setting	Description
<b>Quick Books Server Setup</b>	
Hostname	QuickBooks payroll server. DNS name or IP address of the payroll server.
Port	Port number of Quick Books payroll server. The default value is 57343.

Setting	Description
<b>Synchronization Schedules</b>	
Day of Week	Day of week for scheduled synchronization of TimeCardView data with QuickBooks. Default: Daily
Time of day (HH:MM 24-hr)	Time of day for scheduled synchronization. Default: (none) Example: 23:00
Included Timesheets	Whether to include all timesheets or only approved timesheets. Select All or Approved. Default: All Timesheets
<b>Purge Schedules</b>	
Number of Days Between Purges	Minimum number of days between database purges. Range: 1 - 365 days Default: 90
Days to Keep	Minimum number of days the system must keep data. Range: 1 - 365 days Default: 90



## Maintenance

This section covers these maintenance tasks that can be performed using Configuration Assistant:

- [Cisco UC500 Software and Locale Packs](#)
- [View Software Version Information and Device Properties](#)
- [Software Upgrades](#)
- [Voicemail Upgrade \(UC560\)](#)
- [File Management](#)
- [Restart/Reset Devices](#)
- [How to Localize the UC500 \(Non-US/English Locales\)](#)
- [License Management](#)
- [Phone Load Management](#)

See [Backing Up and Restoring Device Configuration, page 112](#) for instructions on how to use the backup and restore features available from the Maintenance item on the feature bar.

### Cisco UC500 Software and Locale Packs

Read these sections to learn more about UC500 software and locale packs:

- [UC500 Software Packs](#)
- [UC500 Locale Packs](#)
- [Downloading U500 Software and Locale Packs](#)

## UC500 Software Packs

UC500 Software Packs are large zip files that contain all necessary files for the UC500 Series platform and locale. The factory default locale for the UC500 is US/English.

Separate UC500 software packs are provided for the Model UC520, UC540, and UC560 platforms. You must download the correct .zip file for your UC500 platform.

The UC500 software pack bundles all the necessary platform files together with all of the necessary language files and phone files for the default locale, which is US/English. The files are named UC5xx\_8.1.0 .zip.

A software pack zip file contains multiple TAR/archive files and other files for the component of the UC500, including the:

- Cisco IOS image for the UC500 platform
- Cisco IP phone firmware files
- Communications Manager Express (CME) support files
- Cisco Unity Express (CUE) voice mail software
- Factory default configurations for all SKUs
- Support files such as Basic ACD prompts and scripts, ringtones, and desktop images
- Factory default (US/English) locale files:
  - Phone region and language files
  - Voice mail language files

See the *Release Notes for Cisco Configuration Assistant* for compatibility and version information for UC500 software packs.

## UC500 Locale Packs

UC500 Locale Packs can also be downloaded from this location. Locale packs contain the software needed to localize voicemail and phones (locales for Cisco Model 79xx, SPA525, SPA50x, and CP-52x phones).

This means that you only need to download one file to localize voice mail and all supported phone models.

A locale pack can be provided when installing software on the UC500 via CCA in order to install an alternate language on the UC500. Up to two languages can be installed, an active language and an alternate language.

For more information, see [Installing Software on the UC500, page 503](#).

## Downloading U500 Software and Locale Packs

Use one of the following methods to download a UC500 software pack or locale pack:

- In CCA, choose **Partner Connection > UC500 Software Downloads** from the feature bar.
- Open a Web browser and go to this URL:

[www.cisco.com/web/go/uc500swpk](http://www.cisco.com/web/go/uc500swpk)

Users who have a valid Cisco Service Contract are eligible to access current and future versions of software from Cisco (if made available by Cisco). Partners who have not purchased a Service Contract for the Cisco UC500 are eligible to download the current version of the UC500 software within 30 days of the product purchase from Cisco or an authorized Cisco Partner. This gives users a way to obtain a current version of software for the UC500 for the initial deployment of the product.

Access to software for this purpose requires a valid Cisco.com account. Any future software update (if made available by Cisco) beyond the 30-day period of initial purchase from distribution requires a valid service contract.

## View Software Version Information and Device Properties

There are several locations where you can view version information for the SBCS software on the UC500, as well as firmware for connected devices.

- The System Status item on the Dashboard displays the Cisco IOS version.
- Choose **Monitor > Telephony > Software Pack** to view version information for the currently installed UC500 software package, including Cisco IOS, CME, and CUE version, supported phone firmware loads, and CUE status output.
- Right-click on a device in the Topology view to display device properties, including the hostname, IP address, MAC address, and software version (for example, Cisco IOS image) for the device.

When you right-click on an IP phone, you also see the phone type (model), status, phone user first and last name, button types, extensions, and button labels.

## Software Upgrades

To open the Software Upgrade window, choose **Maintenance > Software Upgrade** from the feature bar.

- To learn more about upgrading software for devices that are part of your customer site such as switches, wireless access points, routers, or security appliances, see [Device Firmware Upgrade, page 500](#).
- To learn more about upgrading the software on the UC500, see [Installing Software on the UC500, page 503](#).

### Device Firmware Upgrade

The Software Upgrade window appears when you choose **Maintenance > Software Upgrade > Router/Switch/Security** from the CCA feature bar.

To learn more about upgrading software on CCA-managed devices in the customer site, see these topics:

- [Software Upgrade Window Information](#)
- [Procedures](#)

### Software Upgrade Window Information

This table explains the columns in the Software Upgrade window.

Column	Explanation
<b>Device</b>	Displays device icons and hostnames.
<b>Upgrade</b>	Place a check in the Upgrade box to indicate the device or devices to be upgraded when you click <b>Upgrade</b> . You can select more than one device of the same type.
<b>Device Type</b>	Displays the device type.
<b>Current Version</b>	Displays the version of software currently installed on the device.
<b>New Image Name</b>	Displays the name of the software image that you provided in the Upgrade Settings window. Only the filename appears, not the path.
<b>Upgrade Status</b>	<p>If you have not yet specified software upgrade settings, this field displays the message “Click the Upgrade Settings button to continue.”</p> <p>Once you begin the installation, this field displays upgrade status and progress messages. See <a href="#">Upgrade Status Messages, page 506</a> for details.</p>

### Procedures

Before you begin, download the software image files that you want to install.

Follow these steps to install or upgrade software on devices in the CCA customer site.

- STEP 1** In the Software Upgrade window, select one or more devices from the same platform.
- STEP 2** Click **Upgrade Settings**.
- STEP 3** Complete the settings Upgrade Settings window, and click **OK** to save your input. See [Upgrade Settings, page 502](#).
- STEP 4** If you want to upgrade more than one device type, repeat Steps 1 to 4 for each of the device types.

**STEP 5** Check the **Upgrade** box beside each device that you want to upgrade.

**STEP 6** Click **Upgrade** to start the upgrade process.

**STEP 7** Click **Status** to display the Software Upgrade Status window. This window displays the progress of the upgrade.

When the software upgrade process is completed for all selected devices, a confirmation dialog pops up. The status messages list which devices upgraded successfully and which devices did not. See [Upgrade Status Messages](#), page 506.

**STEP 8** Click **OK**. You are prompted to reload the successfully upgraded devices.

**STEP 9** Choose **Yes** to reload; choose **No** if you do not want to reload the devices. The devices do not use the update until after it is loaded.

**STEP 10** You can also click **Reload Upgraded Devices** to reload the selected devices after they have been upgraded.

All configuration changes are automatically saved to flash memory. After 1 minute, the devices are restarted, and the new image runs. You can then close the Software Upgrade window.

- You can manage the devices in the customer site as soon as they are restarted.
- You lose connectivity to a device when you restart it.

---

## Upgrade Settings

This window appears when you select one or more devices in the Software Upgrade window and click **Upgrade Settings**. Use it to enter the upgrade settings for devices of the same platform.

Configure upgrade settings as described in this table. Click **OK** when you are ready to continue with the upgrade or click **Cancel**.

Setting	Description
<b>Device</b>	Read-only. Displays the selected device name.
<b>Image</b>	Click <b>Browse</b> to locate the software image to use for the upgrade.

Setting	Description
<b>Mode</b>	<p>On some devices you can choose <b>Standard</b> or <b>TFTP</b> mode.</p> <ul style="list-style-type: none"><li>▪ In <i>standard</i> mode if the upgrade images are stored locally.</li><li>▪ In <i>remote TFTP server</i> mode, the software images for the upgrade are stored remotely. To upgrade using remote TFTP server mode, you need a dedicated TFTP server on a UNIX workstation or on another PC. You can run any third-party TFTP application on the remote server.</li></ul> <p>If you choose <b>Remote TFTP Server</b>,</p> <ul style="list-style-type: none"><li>▪ In the <b>Image File</b> field, enter the full path and filename of the Cisco IOS image.</li><li>▪ In the <b>TFTP Server IP Address</b> field, enter the IP address of your TFTP server.</li></ul> <p>You can select multiple site members and upgrade their Cisco IOS images. To perform group upgrades, your TFTP server must handle multiple requests and sessions simultaneously.</p>

## Installing Software on the UC500

The UC500 Software Installation wizard appears when you choose **Maintenance > Software Upgrade > UC500**.

To learn more about preparing for a UC500 software installation, see these topics:

- [UC500 Software Installation Wizard](#)
- [Preparing to Install Software on the UC500](#)
- [Upgrade Status Messages](#)



**CAUTION** Cisco does not recommend that you perform software upgrades over a remote WAN connection. If the connection to the WAN is interrupted, the operation will fail and the system or device may become unusable.

## UC500 Software Installation Wizard

Using the UC500 Software Installation wizard, you can:

- Install a UC500 software pack

This is the preferred way to install and upgrade UC500 software. When using this method, choose **All** when choosing upgrade settings. The UC500 software pack includes Cisco IOS, CUE, related CME phone loads, scripts for Auto Attendant and Basic ACD, US/English locale and language files for phones and voice mail, and support files.

- Install a UC500 locale pack
- Upgrade only the Cisco IOS software image on the UC500
- Upgrade only the CUE voice mail software on the UC500

**NOTE** When downloading a specific CUE or Cisco IOS image from Cisco.com, use the tar version of Cisco IOS images and a CUE package file for CUE voice mail software.

Follow the onscreen instructions in the wizard to install the software.

### Preparing to Install Software on the UC500

To avoid software installation and upgrade failures and other issues, read this section carefully and verify that the system is ready for the installation or upgrade by performing these tasks.

- Verify that your PC meets the requirements for using CCA. See [System Requirements, page 17](#).
- If you have a dual NIC (network interface card) on the PC running Configuration Assistant, make sure that only one of the interfaces is enabled.
- Turn off FTP/TFTP services running on your PC.

Before upgrading, disable any third-party TFTP servers running on your local PC. The embedded TFTP server in CCA is used to transfer images and files from your PC to the device to be upgraded. Only one TFTP server can access the TFTP port at a time.

On the PC running CCA, open a command window and execute the command `netstat -a` to see if any FTP or TFTP services are running. You should not see port 21, 69, FTP, or TFTP in the output. If there are, shut down those processes or services.



If there are no third-party TFTP services running, try restarting your PC to release TFTP ports that may still be in use from a prior CCA session.

- Ensure that the PC has obtained a DHCP address from the UC500 and the default gateway is set correctly.

On the PC running CCA, open a command window and execute the command `ipconfig /all`. The Default Gateway IP address shown in the output should be obtained from the UC500 (the default value is 192.168.10.1).

- Any firewall software installed on the PC running CCA should be configured to allow TFTP and FTP access to and from the UC500.

A firewall running on your PC can potentially block the connection between the CUE module on the UC500 and CCA, which can result in an upgrade failure.

If you disable the firewall running on the PC while performing an upgrade, be sure to re-enable it after the upgrade.

- Verify the CUE interface status. To do this, choose **Troubleshoot > CUE Diagnostics > CUE Connectivity Diagnostics** from the feature bar and click **Check Status**. You should see the line “Integrated-Service-Engine0/0 is up, line protocol is up” in the “show interfaces” section near the top of the output if the CUE interface module is running.

## Software Upgrade Status

This window appears when you select a device and click **Status** in the Software Upgrade window. The window shows detailed messages as they are generated from the device during an upgrade.

If there is insufficient space on the device to install the new image, a message with a link to the File Management window appears. You can use the File Management window to manage your file systems, and, if necessary, to delete old images to make space for new images.

### Upgrade Status Messages

This table explains upgrade status messages.

Message	Explanation
<b>Click the Upgrade Settings button to continue</b>	The Upgrade Settings window must be completed before the device can be upgraded.
<b>Click the Upgrade button to upgrade the device</b>	All the parameters are set for the device to be upgraded.
<b>Reload started for the device</b>	The device is reloading after a successful software upgrade. Even after the reload is completed, this message appears until you refresh the window.
<b>Software upgrade was successful</b>	The upgrade completed successfully.
<b>Software upgrade failed</b>	The upgrade failed. See the Status window for more information.  <b>IMPORTANT</b> If a UC500 upgrade fails, verify that you have performed all the tasks listed in the <a href="#">Preparing to Install Software on the UC500, page 504</a> .
<b>Software upgrade in progress</b>	The upgrade for the devices is in process.
<b>Uploading the image</b>	The image is being uploaded to the device.
<b>Verifying the image</b>	The device is verifying the image.

## Voicemail Upgrade (UC560)

The UC560 platform supports upgrade of the Voicemail Compact Flash from the factory default size of 2 GB to 4 GB or 8 GB to increase voice mail storage capacity. Once the compact flash is replaced and the UC560 is restarted, you are prompted to install voice mail software and language files on the new Voicemail Compact Flash.

See these sections for more information:

- [Preparing for a Voicemail Upgrade](#)
- [Replacing the Voicemail Compact Flash on the UC560 and Performing a Voicemail Upgrade](#)

### Preparing for a Voicemail Upgrade

Before performing a voicemail upgrade:

- If you have a dual NIC (network interface card) on the PC running Configuration Assistant, make sure that only one of the interfaces is enabled.
- Any firewall software installed on the PC running CCA should be configured to allow TFTP and FTP access to and from the UC500.
- Shut down any third-party TFTP or FTP servers running on the PC running CCA.
- If there are no third-party TFTP services running, try restarting your PC to release TFTP ports that may still be in use from a prior CCA session.
- If the UC500 is not in factory default state:
  - Save the running configuration to the startup configuration. See [Applying and Saving the Configuration, page 47](#).
  - Back up the current UC500 configuration and [Backing Up and Restoring Device Configuration, page 112](#).
- Make sure you have downloaded the latest UC500 software pack for the UC500 platform (for example, UC560-8.1.0.zip or later) to the PC running CCA. The software pack contains the latest CUE voice mail software (SCUE\*.zip file).
- If you require a locale other than US/English or want to install files for an alternate locale, you must also download the appropriate UC500 locale packs. See [UC500 Locale Packs, page 498](#).

To download UC500 locale packs, go to: [www.cisco.com/go/uc500swpk](http://www.cisco.com/go/uc500swpk).

- If desired, download copies of custom files from the UC500 flash to our PC using the CCA File Management window (**Maintenance > File Management**). See [File Management, page 520](#).

## Replacing the Voicemail Compact Flash on the UC560 and Performing a Voicemail Upgrade

A larger capacity Voicemail Compact Flash for the UC560 can be ordered from Cisco as a spare (UC500-8GB= for the 8-GB flash and UC500-4GB= for the 4-GB flash).



**WARNING** Before installing a new Voicemail Compact Flash on the UC560, you must save and back up the configuration on the UC560 and then power down the UC560. Failure to do so can cause the system to become inoperable or result in data loss.

To replace the Voicemail Compact Flash on the UC560 and perform a voicemail upgrade using CCA, perform these steps.

- STEP 1** Make sure that you have performed the tasks listed in [Preparing for a Voicemail Upgrade, page 507](#).
- STEP 2** Power down the UC560.
- STEP 3** Locate the Voicemail Compact Flash slot and remove the existing Voicemail Compact Flash.
- STEP 4** Insert the new compact flash in the Voicemail Compact Flash slot.
- STEP 5** Power on the UC560.
- STEP 6** With the PC running CCA connected to the LAN side of the UC500, launch CCA and connect to the UC560.

CCA detects that a new Voicemail Compact Flash is installed, displays a message informing you that there is no CUE voice mail software installed, and asks you if you want to install it.

- If you choose **Yes**, the UC500 Software Installation wizard appears.
- If you choose **No** or close the window, you can always re-open it from the feature bar by choosing **Maintenance > Software Upgrade > UC500**.

Because the new Voicemail Compact Flash does not have any software or data on it, voicemail features are not available on the system until you install the voice mail software.

- STEP 7** Follow the onscreen instructions in the UC500 Software Installation wizard to install voice mail software and language files. When asked to choose an installation option, choose **Voicemail Software**.

The upgrade process takes approximately 30 minutes.

CCA performs a restore from the most recent voicemail backup after the software installation completes.

**STEP 8** To verify that the voice mail software installation completed successfully

- Open the Voicemail window (**Configure > Telephony > Voicemail**) and verify that the available voicemail storage data reflects the increased capacity.
- Make calls, leave voice mail messages, and retrieve messages to verify that the voice mail system functions as expected.
- Retrieve existing voice mail to verify that old voice mails are accessible as expected.

**STEP 9** Save the configuration (**Configure > Save Configuration**).

**STEP 10** Back up the new configuration (**Maintenance > Configuration Archive, Backup**).

---

## License Management

To manage licenses, choose **Maintenance > License Management** from the feature bar.

License management options differ between UC520 and UC540 platforms. These options are discussed in more detail in these sections:

- [Overview, page 509](#)
- [License Types, page 510](#)
- [UC520 License Management, page 511](#)
- [UC540 and UC560 License Management, page 512](#)

### Overview

Cisco Software Licensing is supported on the UC500 Series platforms so that they can be modified in the field. For example, a system licensed for 8 users that physically supports 16 users can be upgraded to a 16-user license. Licenses can also be downgraded.

IP phones are registered, based on the availability of a license for each phone. On UC520 platforms, when a system license is downgraded due to license expiration or by configuration by the user and the number of registered phones exceeds the user license count, the system reloads.

These software licensing features are available:

- For the UC520 platform, evaluation, extension, permanent, and grace-period licenses are supported.
- For UC540 and UC560 platform, evaluation and permanent licenses are supported. The UC540 and UC560 platforms support PAK (Product Authorization Key) license upgrades.
- Installation and expiration events are managed by the licensing infrastructure.

### License Types

Configuration Assistant supports four types of licenses, which are described in this section.

License Type	Description
<b>Evaluation License</b>	<p>Evaluation licenses are non-node locked, metered licenses that are bundled with a Cisco IOS image and valid for a limited period of time. The license is used only when there is no permanent, extension, or grace-period licenses for a feature. You must accept the EULA (End User License Agreement) before using this license.</p> <p>Every time you connect to or refresh the network, Configuration Assistant notifies you of the status of a temporary license by using the Event Notification window. You are also notified if the license for any feature expires within 10 days or less, and the system recommends that you install a permanent license.</p>
<b>Permanent License</b>	<p>Permanent licenses are node-locked licenses with no associated usage period, issued through the Cisco licensing portal. For UC520 platforms, you must accept the EULA as part of the installation of the license.</p>

License Type	Description
<b>Extension License</b>	UC520 only. Extension licenses are node-locked metered licenses, issued through the Cisco licensing portal. For UC520 platforms, you must accept the EULA as part of the installation of the license.
<b>Grace-Period License</b>	UC520 only. Grace-period licenses are node-locked metered licenses, issued through the Cisco licensing portal as part of the permission ticket to rehost a license. These licenses are installed on the device as part of the rehost operation. You must accept the EULA as part of the rehost operation for this type of license.

### UC520 License Management

To view license information or install a license, choose **Maintenance > License Management** on the feature bar.

This table lists and describes UC520 licenses information displayed in this window.

Setting	Description
<b>Device/Feature</b>	Displays available devices and currently installed user licenses.
<b>Device ID</b>	Read-only. Displays the unique device identifier for the UC520. For example: UC520W-FXO-K9:FFH104001MR.
<b>Current Capabilities</b>	Current number of user licenses installed on this UC520.
<b>Maximum Capabilities</b>	Maximum number of user licenses supported for this UC520 SKU.
<b>License Type</b>	License can be permanent, evaluation, extension, or grace period.

Setting	Description
<b>Expiry Period</b>	For permanent licenses, Lifetime is always displayed for the Expiry period.  For evaluation Licenses, the Expiry Period is the amount of time remaining until the evaluation license expires.
<b>Action</b>	Available options include <b>None</b> or <b>Select License File</b> .

To install an **evaluation** license, follow these steps:

- 
- STEP 1** In the License Management window, click on the UC500 device for which you want to view or install the evaluation license.
  - STEP 2** From the Action list for the device, select **Evaluation License**.
  - STEP 3** Click **Apply** or **OK** to install the licenses. The related fields are updated.
- 

To install a **permanent** or an **extension** license, follow these steps:

- 
- STEP 1** From the Action list for the device, choose **Select License File**. The Upload License File dialog appears.
  - STEP 2** Click **Browse** to navigate to the location of the license file, then click **OK**. See [Upload License File, page 517](#).

To cancel a license upgrade, click **Cancel** before you click **Apply** or **OK**. The installation is canceled, and the original license status appears.

- STEP 3** Click **Apply** or **OK** to install the license. The related fields are updated.

When the licenses are successfully installed, the Capabilities column updates to reflect the additional licenses.

---

### UC540 and UC560 License Management

Software licensing on the UC540 and UC560 platforms supports the Software PAK (Product Authorization Key) mechanism for license upgrades. For details, see the next section, [License Management Actions, page 513](#).



This table lists and describes UC540 licenses information displayed in this window.

Setting	Description
<b>Device/Feature</b>	Displays available devices and currently installed licenses. UC540 and UC560 device licenses are listed as Pro User License.
<b>Device ID</b>	Read-only. Displays the unique device identifier for the UC540 or UC560 device.  For example: UC540W-FXO-K9:FFH104001MR.
<b>Current Capabilities</b>	Current number of licenses installed on this UC540 or UC560.
<b>Maximum Capabilities</b>	Maximum number of licenses supported. For the UC540, this is 32. The UC560 supports up to 104 user licenses.
<b>License Type</b>	For the UC540 and UC560, this can be Permanent or Evaluation. Licenses can be either Active or Inactive.
<b>Expiry Period</b>	For permanent licenses, Lifetime is always displayed for the Expiry period.  For evaluation Licenses, the Expiry Period is the amount of time remaining until the evaluation license expires.
<b>Action</b>	For active licenses, click <b>Manage</b> to open the License Management Details window, where you can install, upgrade, transfer, activate, and deactivate licenses. See <a href="#">License Management Actions, page 513</a> .

## License Management Actions

This window appears when you select a UC540 or UC560 in the License Management window, select a license, and click **Manage**.

## Overview

The UC540 platform ships from the factory with 8 permanent licenses installed and active; the UC560 platform ships with 16 permanent licenses installed and active. These factory-installed licenses cannot be transferred, revoked, or modified.

The maximum number of user licenses for the UC540 platform is 32. For the UC560, the maximum number of user licenses is 104. Additional licenses can be added in sets of 8 using a Product Authorization Key (PAK) or added through a license file. If the maximum number of licenses are already installed, the upgrade license from a PAK and install license options are disabled.

The configuration fields displayed in this window vary, depending on the license management action you choose. These actions can be performed:

- [Upgrade License Using a PAK \(Product Authorization Key\), page 514](#)
- [Transfer License To or From This Device, page 515](#)
- [Install License From File, page 517](#)
- [Activate or Deactivate Evaluation License, page 517](#)

### Upgrade License Using a PAK (Product Authorization Key)

Choose the **Upgrade License Using PAK (Product Authorization Key)** option if you want to install additional licenses using a PAK. This option is unavailable if the maximum number of licenses are already installed.

The SWIFT (Software Infrastructure and Fulfillment Technology) database is contacted and updated when licenses are upgraded.

To install an upgrade license using a PAK, follow these steps.

---

**STEP 1** In the **Actions** section of the window, choose **Upgrade License Using a PAK (Product Authorization Key)**.

The Device ID at the top of the window displays the unique ID for this UC540 device.

**STEP 2** In the **Action Details** section of the window, complete settings as described below.

Settings	Description
<b>Cisco.com User</b>	Enter your Cisco.com user ID.
<b>Cisco.com Password</b>	Enter your Cisco.com password.
<b>Email Address</b>	Enter a valid email address. This is the address to which notification emails from SWIFT are sent.
<b>Number of PAK to install</b>	Select the number of PAKs (Product Authorization Keys) to install from the drop-down list; from 1 to 3 for the UC540 or from 1 to 8 for the UC560.
<b>PAK-1 to PAK-3 (UC540) PAK-1 to PAK-8 (UC560)</b>	Enter the Product Authorization Key for each license to be installed.

**STEP 3** Click **OK** to close the License Management Actions window and return to the License Management window.

### Transfer License To or From This Device

Choose **Transfer License to or From This Device** if you want to:

- Revoke and remove licenses from this UC540 or UC560 device and save them to a file, or
- Transfer previously saved licenses to another UC540 or UC560 device.

When you remove licenses from a UC540 or UC560:

- The licenses are stored in a file on the PC running Configuration Assistant.
- The location is displayed in the License Management Actions window.

When you transfer the license to a different UC540 or UC560 make sure that file is present on the PC running Configuration Assistant. Use the same PC to remove and transfer the licenses or copy the saved license file to same location on the PC to be used for the license transfer.

The SWIFT (Software Infrastructure and Fulfillment Technology) database is contacted and updated when licenses are revoked and transferred.

To remove licenses from one UC540 or UC560 for transfer to another UC540 or UC560, follow these steps.

**STEP 1** In the **Actions** section of the License Management Actions window, choose **Transfer License To or From This Device**.

**STEP 2** In the **Action Details** section of the window, complete settings as described below.

Settings	Description
<b>Cisco.com Username</b>	Enter your Cisco.com user ID.
<b>Cisco.com Password</b>	Enter your Cisco.com password.
<b>Email Address</b>	Enter a valid email address. This is the address to which notification emails from SWIFT (Software Infrastructure and Fulfillment Technology) are sent.
<b>Transfer Type</b>	Choose <b>Remove License and Save for Transfer</b> .

**STEP 3** When you click **OK**, the system connects to the SWIFT database and revoke the license. The license is removed from the UC540 or UC560 and saved to a file on the PC running Configuration Assistant.

The location of the file on the local PC is displayed in the License Management Actions window.

To install a previously saved license transferred from another UC540 or UC560, follow these steps.

**STEP 1** In the **Actions** section of the window, choose **Transfer License To or From This Device**.

**STEP 2** In the **Action Details** section of the window, complete settings as described below.

Settings	Description
<b>Cisco.com Username</b>	Enter your Cisco.com user ID.
<b>Cisco.com Password</b>	Enter your Cisco.com password.

---

Settings	Description
<b>Transfer Type</b>	Choose <b>Transfer Previously Saved License</b> .  Choose the license to install from the <b>Discovered Licenses</b> drop-down list menu. When discovering licenses, Configuration Assistant looks only in the location in which the license was previously saved.

---

- STEP 3** Click **OK** to install the license and close the License Management Actions window. You are returned to the License Management window.
- 

### Install License From File

Choose **Install License File** if you want to manually install a license using a license file.

To install a license from a file, follow these steps.

- 
- STEP 1** In the **Actions** section of the window, choose **Install License from File**.
- STEP 2** In the **Action Details** section of the window, click **Browse** and locate the license file to install, then click **OK**. See [Upload License File, page 517](#).
- STEP 3** Click **Apply** or **OK** to install the license and close the License Management Actions window.
- 

### Activate or Deactivate Evaluation License

To activate or deactivate a license choose **Activate Evaluation License** or **Deactivate Evaluation License**, then click **OK**. No other information is required.

### Upload License File

The Upload License File dialog appears when you are managing licenses on a UC520 and choose **Select a License File** from the Actions drop-down list in the License Management window.

Click **Browse** to navigate to the location of the license file on your system, then click **OK** to upload the license file.

The license file will have a .lic or .xml extension.

---

## Restart/Reset Devices

To open the Restart/Reset window, choose **Maintenance > Restart/Reset** from the feature bar.

### Overview

You can *restart* devices in your customer site or *reset* them to their factory defaults.

- Restarting a device saves the active configuration file and starts it again. A device is not accessible while it is being restarted, and connectivity is interrupted briefly between the device and its end stations.
- Resetting a device restores the settings that it had when it was new from the factory. After a device is reset to factory default, you can use one of the device setup wizards to establish the configuration or re-configure the device manually.

**NOTE** When resetting a device, the DHCP server might assign a new IP address to a reset device. If this happens, the CCA Topology view shows that the device is unreachable. Right-click on the device in the Topology view and choose **Add to Site** to re-add the device to its customer site with its new IP address.

### Procedures

To restart or reset a device in your customer site, follow these steps:

---

**STEP 1** In the Restart/Reset window, select the device you want to restart or reset.

**STEP 2** Choose one of these steps:

- Check the **Restart** option.
- Check the **Reset to Factory Defaults** option.
- Check both options.

**STEP 3** Click **OK**.

---

### To Restart CUE

For the UC500, you can also choose to restart the Cisco Unity Express module only. Voice mail, Auto Attendant, and other telephony applications run on the CUE module.



**CAUTION** You should only restart the CUE module if instructed to by Cisco TAC to address a specific issue or if required as part of a related operation in Configuration Assistant, for example, forcing a re-read of installed language files for the Cisco WebEx PhoneConnect application.

A CUE restart can take from 10 to 15 minutes. During this time, voice mail, Auto Attendant, and telephony applications such as Cisco WebEx PhoneConnect and TimeCardView are unavailable.

To restart the CUE module, choose **Home** > **Topology** to open the Topology view, right-click on the UC500 icon in the Topology view, and choose **Restart CUE** from the menu.

**TIP** To access CUE diagnostic and troubleshooting tools, go to **Troubleshoot** > **Telephony Diagnostics** > **CUE Diagnostics** > **CUE Connectivity Diagnostics**. For more information, see [CUE Connectivity Diagnostics, page 573](#).

## How to Localize the UC500 (Non-US/English Locales)

The default system locale for the UC500 is US/English.

To localize the UC500, phones, and voicemail for a different locale, perform these steps.

**STEP 1** Download the latest UC500 software pack if needed, and download the UC500 locale packs for the desired locales.

See [Downloading U500 Software and Locale Packs, page 499](#).

**STEP 2** To install the software and locale packs, choose **Maintenance** > **Software Upgrade** > **UC500** and follow the onscreen instructions.

See [Installing Software on the UC500, page 503](#).

**STEP 3** In the Outgoing Dial Plan window, choose the numbering plan locale that corresponds to the desired locale or upload a custom, localized dial plan.

See [Outgoing Dial Plan, page 430](#).

---

## File Management

To manage the file system on the compact flash for the UC500 or the file system for other Cisco IOS devices, choose **Maintenance > File Management** from the feature bar.

**TIP** The Flash Usage item on the Dashboard view provides information about the percentage of used and available storage on the compact flash. To open the Dashboard, choose **Home > Dashboard** from the feature bar. You can remove phone loads from the flash to free up space, if needed. See [Phone Load Management, page 524](#).

### Overview

From the File Management window, you can

- View the file systems of any Cisco IOS devices while the devices are connected to a live network
- Perform basic file management operations on these file systems
- Delete files from the flash

For example, when performing a software upgrade, you might have insufficient space to install the new image, and therefore you might need to delete the old image to make room for the new image

- Upload and download files to and from the flash

### Procedures

The File Management window has two tabs:

- **Overview**
- **Files**



## Overview

This table explains the columns in the **Overview** tab.

Column	Explanation
<b>Device/File System</b>	Lists the devices selected and the file systems on those devices.
<b>Status</b>	<p>Status for a file system can be any one of these:</p> <ul style="list-style-type: none"> <li>▪ <b>Blank</b>—No status to report.</li> <li>▪ <b>Squeeze Needed</b>—There are deleted files on a class B file system.</li> <li>▪ <b>Squeeze in Progress</b>—Currently purging files marked for deletion.</li> <li>▪ <b>File System in Use</b> — File system information is unavailable. Click <b>Refresh</b> to try again.</li> <li>▪ <b>File System Full</b>—There is no free space left in the file system.</li> <li>▪ <b>File System Empty</b>—There are no files in the file system.</li> <li>▪ <b>File System is Read-only</b>—The file system is locked and cannot be modified. This is often due to a physical switch setting on a compact flash card.</li> </ul>
<b>Capacity</b>	Size of the file system rounded to the nearest megabyte (MB).
<b>Free Space</b>	Number of megabytes free in the file system, rounded to the nearest MB.
<b>% Free Space</b>	Percentage of the total file system that is unused.
<b>Files</b>	Number of files on the file system. Directories on Class C file systems and deleted files on Class B file systems are counted as files.

## Files

This table explains the columns on the **Files** tab.

Column	Explanation
<b>Device/File System</b>	Lists the devices selected and the file systems on those devices. Below each file system is a list of directories and files.
<b>Squeeze</b>	This action is available only when there is a deleted file on a device with a Class B file system. Check the box provided to permanently remove deleted files from the file system. The check box is not available if the file system is read-only or if there are no deleted files on the file system.
<b>Size</b>	Lists the sizes of individual files in KB.
<b>Type</b>	Lists the file type of individual files, if available. Common file types would include System Image, Cisco IOS Image, and Configuration.
<b>Modified</b>	Lists the file modification date and time.
<b>Delete</b>	Check the box for a file to select it for deletion. If the file is in a Class B file system and a file is already marked for deletion, the box is checked.
<b>Restore</b>	Appears only for devices that have Class B file systems with deleted files. Check the boxes to select which files to undelete.

### Uploading, Downloading, and Deleting Files on the Flash

You can upload and download files to and from the compact flash on the UC500 or other CCA-managed Cisco IOS devices. For example, you can upload custom ringtone files, phone desktop images, music on hold files, custom Auto Attendant scripts, or support files as directed by Cisco Support. You can download copies of files on the flash to your local machine to archive them or to upload them to another device.

**IMPORTANT** CCA uses a built-in FTP service to transfer files between your PC and the compact flash on the UC500 or other CCA-managed Cisco IOS devices. You must disable any other third-party FTP services running on your PC before you can transfer files. If there are no third-party FTP services running, check the firewall and network security settings on your PC to make sure that FTP traffic is allowed between the PC and the device or try restarting your PC.

---

To upload a file from your local machine to the compact flash on a Cisco IOS device, follow these steps.

- 
- STEP 1** In the File Management window, select the **Files** tab.
  - STEP 2** In the **Device/File System** tree, select the device and navigate to the location on the flash where you want to upload the file.

Make sure that you upload the file to the correct location on the flash. For example, Music on Hold audio files are uploaded to the `flash:\media` directory. For more information, see the Cisco Unified CME documentation on Cisco.com.

- STEP 3** Click **Upload**.
- 

To download a copy of one or more files from the compact flash on a Cisco IOS device to your local machine, follow these steps.

- 
- STEP 1** In the File Management window, select the **Files** tab.
  - STEP 2** In the **Device/File System** hierarchy, select a device and navigate to the folder on the flash that contains the file or files you want to download.
  - STEP 3** Click on the names of the files that you want to download to select them.

You can use the Windows CTRL-Left mouse button and Shift-Left mouse button keyboard shortcuts to select multiple files.

The **Download** button is not active until you select at least one file.

- STEP 4** Click **Download**.
- 

To delete one or more files from the compact flash on a Cisco IOS device, follow these steps.



---

**CAUTION** Do not delete the system boot image or any of these files on the UC500 flash: `vlan.dat`, `config.txt`, `env_vars`, `private_config.txt`, and `system_env_vars`.

---

- 
- STEP 1** In the File Management window, select the **Files** tab.
- STEP 2** In the **Device/File System** hierarchy, navigate to the folder on the flash that contains the folder or files you want to delete.
- STEP 3** Check the box in the same row as the file or folder that you want to delete.
- You can select more than one file or folder to delete. When you select a folder, all files in the folder and its subfolders will be deleted.
- STEP 4** Click **Apply**.
- STEP 5** If you want to permanently remove the file from a Class B file system, perform a squeeze operation on the file system where the file exists.
- STEP 6** Follow these steps to restore a file that has not been permanently deleted by a squeeze operation:
- Check the box in the same row as the file that you want to restore.
  - Click **Apply**.
- STEP 7** Follow these steps to squeeze a Class B file system:
- Check the box in the same row as the file system that you want to squeeze.
  - Click **Apply**.
- When squeezing a file system, if there are files in it marked to be restored, those files are restored before the squeeze operation. Files marked for deletion are removed before the squeeze operation. Squeeze operations can take several minutes.
- 

## Phone Load Management

To access phone load management options, choose **Maintenance > Phone Load Management**.

- [Overview](#)
- [Delete Phone Loads](#)
- [Upload Phone Loads](#)

- **Drag-and-Drop Phone Upgrades (SPA500 Series, SPA300 Series, 6900 Series, and Selected 7900 Series IP Phones)**

### Overview

From the tabs on the Phone Load Management window, you can:

- Replace or add phone loads to the UC500 compact flash by specifying a UC500 software pack. The phone loads are extracted from the software pack and uploaded to the UC500.
- Remove phone loads from the compact flash on the UC500 to optimize space on the flash.
- Replace a specific phone load by deleting the version that is currently on the system and then uploading a newer version.

In order to upload phone load files to the UC500, make sure that you have disabled any third-party TFTP or FTP servers running on the PC that is running Configuration Assistant.

### Delete Phone Loads

When you choose the Delete Phone Loads tab, all phone loads on the UC500 flash are displayed in the list.

- A checkbox is displayed in the Select column for all phone loads available on the UC500 flash.
- Phone loads that are not in use on the system are checked and can be safely deleted.
- Phone loads that are in use are unchecked.

To delete a phone load, follow these steps.

- 
- STEP 1** Click on the row in the table for that phone load to highlight it.
  - STEP 2** Make sure that checkbox in the **Select** column for that phone load is checked.  
Click **Delete**.
  - STEP 3** Repeat the above steps to delete additional phone loads.

As you delete phone loads, the **Flash space available** fields update to reflect flash usage after the deletion.

**STEP 4** Click **OK** when you are finished deleting phone loads.

---

### Upload Phone Loads

To upload phone loads to the UC500, follow these steps.

---

**STEP 1** Click **Browse** and locate the UC500 software pack (.zip file) that contains the phone loads you want to upload., for example `UC520-7.0.3.zip` or `UC540-7.1.1.zip`.

Once you have selected the UC500 software pack file, CCA analyzes the phone loads in the software pack and the ones in use on your system.

When the software pack analysis completes, the list of phone loads available in the specified image are displayed. Phone loads that are already in use on your system are selected for upload.

Click the checkbox in the **Select** column to select or deselect phone loads from the list of those to be uploaded.

**NOTE** The 521\_524 phone loads for CP500 phones cannot be deselected. You must upgrade to the latest firmware for these phones to function correctly.

**STEP 2** Click **Upload** to upload the selected phone loads to the UC500.

**STEP 3** Click **OK** to close the Phone Load Management window.

---

### Drag-and-Drop Phone Upgrades (SPA500 Series, SPA300 Series, 6900 Series, and Selected 7900 Series IP Phones)

The drag-and-drop phone load upgrade method can be used to upgrade firmware for the following IP phones:

- Cisco Model 6901, 6911, 6921, 6941, and 6961 IP phones (Model 6945 is not supported)
- Cisco SPA500 Series IP phones (including SPA525G and SPA525G2)
- Cisco SPA300 Series IP phones
- Cisco Model 7975, 7970, 7971, 7945, 7965, 7942, 7962, 7941, 7961, 7931, 7911, and 7906 IP phones

These guidelines and notes apply to drag-and-drop phone load upgrades:

- This upgrade method is supported only the phones listed above. CCA displays a message if it does not recognize the file format of the phone load file.
- For most Cisco Model 79xx phones, you do not have to extract the files from the .zip archive. For Cisco SPA500 Series and 300 Series phones, you must extract the .bin file from the archive before dragging and dropping it onto the topology. Cisco Model 7921 and 7925 phone loads are packaged in .tar files that you can drag-and-drop onto the UC500 icon.
- You cannot drag and drop more than one file at a time.
- Phone loads are copied into the `flash:phones/` directory on the UC500 flash and placed under the appropriate subdirectory for the phone model. For example: `flash:phones/525` or `flash:phones/5x5`.
- Once the upgraded firmware is downloaded, it can be managed through the Phone Load Management window in CCA.

To upgrade Cisco IP phones using the drag-and-drop method, follow these steps.

- 
- STEP 1** Download the phone software from Cisco.com. A Cisco.com login is required.
  - STEP 2** Launch CCA and connect to the customer site or UC500 device.
  - STEP 3** Choose **Home > Topology** to open the Topology View if it is not already open.
  - STEP 4** On the PC running CCA, locate the phone firmware file that you downloaded from Cisco.com. For example: `spa525g-7-4-3.bin`.
  - STEP 5** In the Topology View, use the mouse to drag the phone load (.zip or .bin) file from your PC and drop it onto the UC500 icon.

If CCA recognizes the file as a valid phone load, a pop-up dialog displays and you are prompted to upload the file.

- STEP 6** Click **Upload**. The dialog displays the upload and upgrade progress.

After the upgrade is applied, you are prompted to restart all affected phones.

To restart a phone using CCA, open the Topology View, right-click on the phone icon, and choose **Reboot**.

---





# Monitoring

Read this section to learn about reports and diagnostic information that can be monitored for devices in a customer site. To access system monitoring options, choose **Monitor** from the feature bar.

These report categories and monitoring tools are available:

- **Network**
- **Security**
- **Telephony**
- **Inventory**
- **Health**
- **Event Notification**
- **System Log**
- **System Messages**
- **Multisite Status**

---

## Network

To access network status monitoring options, choose **Monitor > Network** from the feature bar. These network monitoring reports and tools are available:

- **Port Statistics**
- **Bandwidth Graphs**
- **Link Graphs**
- **Wireless Usage**
- **T1/E1/BRI Status**
- **DNS and Hosts**

### Port Statistics

To access Port Statistics, choose **Monitor > Network > Port Statistics** from the feature bar.

Port Statistics are available for Cisco ESW500 Series switches and Cisco CE520 switches only.

From the Port Statistics window, you can display port information such as statistics on link performance, dropped packets, and total errors. To see a condensed, graphical view of port statistics, use the **Bandwidth Graphs** window.

- To see these statistics for the ports on a given device, select the device from the Hostname list.
- To refresh the statistics, click **Refresh**.
- To clear the statistics for all the ports on the selected device, click **Clear Counters**.
- To save the report to a local drive, click **Save Report**. In the window that appears, you select a folder for storing the report.

This table explains the data on each of the tabs: Overview, Transmit Detail, and Receive Detail.

Tab	Column	Explanation
Overview	Interface	Port interface name (for example, on an ESW-540-8P switch, the interfaces are numbered g1 through g9).
	Port Description	ESW500 switches only. Text description for this port, if configured on the switch.
	Transmit Rate	The current transmit rate in Mbps. It includes the transmission of bad packets and retransmission because of collisions in half-duplex operations.
	Receive Rate	The current receive rate in Mbps. It includes the data bytes of bad packets, discarded packets, and no-destination packets.
	Transmit Bandwidth Usage	The percentage of the bandwidth usage for transmission, based on the current transmit rate and actual speed.
	Receive Bandwidth Usage	The percentage of the bandwidth usage for reception, based on the current receive rate and actual speed.
	Transmit Packet Rate	The current transmit rate of well-formed packets. It includes unicast, multicast, and broadcast packets.
	Receive Packet Rate	The current receive rate of well-formed packets. It includes unicast, multicast, and broadcast packets.
	Transmit Multicast/Broadcast Packet Rate	The current transmit rate of well-formed multicast and broadcast packets. It excludes unicast packets.
	Receive Multicast/Broadcast Packet Rate	The current receive rate of well-formed multicast and broadcast packets. It excludes unicast packets.
	Total Discarded Packets	The total number of packets discarded from both transmission and reception.

Tab	Column	Explanation
<b>Overview</b>	Total Packets with Errors	The total number of packets with errors from both transmission and reception.
<b>Transmit Packets</b>	Interface	Port interface name (for example, on an ESW-540-8P switch, the interfaces are numbered g1 through g9).
	Port Description	ESW500 switches only. Text description for this port, if configured on the switch.
	Unicast	The total number of well-formed unicast packets transmitted by a port. It excludes packets transmitted with errors or with multicast or broadcast destination addresses.
	Multicast	The total number of well-formed multicast packets transmitted by a port. It excludes packets transmitted with errors or with unicast or broadcast destination addresses.
	Broadcast	The total number of well-formed broadcast packets transmitted by a port. It excludes packets transmitted with errors or with unicast or multicast destination addresses.
	Total Collision	The total number of packets transmitted without error after having 1 to 15 collisions. It includes packets of all destination address types and excludes packets discarded because of insufficient resources or late collisions.
	Excessive Collision	The total number of packets that failed to be transmitted after 16 collisions. It includes packets of all destination address types.
	Late Collision	The total number of packets discarded because of late collisions detected during transmission. It includes all transmit packets that had a collision after the transmission of the packet's 64th byte. The preamble and SFD are not included in the frame's byte count.

Tab	Column	Explanation
<b>Receive Packets</b>	Interface	Port interface name (for example, on an ESW-540-8P switch, the interfaces are numbered g1 through g9).
	Port Description	ESW500 switches only. Text description for this port, if configured on the switch.
	Unicast	The total number of well-formed unicast packets received by a port. It excludes packets received with errors, with multicast or broadcast destination addresses, or with oversized or undersized packets. Also excluded are packets discarded or without a destination.
	Multicast	The total number of well-formed multicast packets received by a port. It excludes packets received with errors, with unicast or broadcast destination addresses, or with oversized or undersize packets. Also excluded are packets discarded or without a destination.
	Broadcast	The total number of well-formed broadcast packets received by a port. It excludes packets received with errors, with unicast or multicast destination addresses, or with oversized or undersize packets. Also excluded are packets discarded or without a destination.
	Discarded	The total number of packets discarded because of insufficient receive bandwidth or receive buffer space, or because the forwarding rules stipulate that they not be forwarded.

Tab	Column	Explanation
<b>Receive Packets</b>	Alignment Errors	The total number of packets received with alignment errors. It includes all the packets received with both an FCS error and a non-integral number of bytes.
	FCS Errors	The total number of packets received with FCS errors. It excludes undersized packets with FCS errors.
	Collision Fragments	The total number of frames of less than 64 bytes that have an integral number of bytes and bad FCS values.
	Undersize Packets	The total number of packets received of less than 64 bytes that have good FCS values.
	Oversize Packets	The total number of packets received of more than 1518 bytes that have good FCS values.

## Bandwidth Graphs

From the Bandwidth Graphs window, you can see an estimate of the traffic flowing through the device you choose from the Hostname list. Bandwidth Graphs are available for CE520 switches only.

To display a bandwidth graph for a CE520 switch, take any of these actions:

- Right-click a site member in the Front Panel view and choose Bandwidth Graphs from the popup menu.
- Right-click or double-click a site member in the Topology view and choose Bandwidth Graphs from the popup menu.
- Select a site member in either view, and choose **Monitor > Network > Bandwidth Graphs** on the feature bar.

### Overview

For a selected Catalyst Express 500 switch, a bandwidth graph gives you these estimates:

- How much of its bandwidth is being used, starting at the time the graph appears

- How much of its bandwidth was used, in the past minute, hour, day, or 2-week period

### Procedures

The window has these tabs:

- **Time Series**, which shows the percentage of bandwidth utilized, starting at the time the window appears.
- **Trends**, which shows the percentage of bandwidth utilized in the past minute, hour, day, or 2-week period.

### Time Series

You can manipulate the graph on this tab by

- Selecting the type of graph displayed
- Changing the increments on the x-axis
- Changing the polling interval
- Scrolling the x-axis

### Selecting the Type of Graph to Display

From the Type list, click Line or Bar to select a type of graph. In a line graph, data points are connected by a line. In a bar graph, data points are denoted by the height of bars.

### Changing the Increments on the X-Axis

By default, the time increments on the x-axis are 2 minutes apart. To make them closer together or farther apart, click the Zoom buttons.

### Changing the Polling Interval

At a regular interval, Configuration Assistant queries the managed devices to gather device- and link-utilization data. This interval is called the graph polling interval. To set it, open the Preferences window, click the General tab, and choose a value for the Graph Polling Interval field.

Note: When the traffic level on a device drops dramatically, you do not see a change in the graph for at least 15 minutes, regardless of the setting for the graph polling interval.

### Scrolling the X-Axis

You can use the scroll bar at the bottom of the graph to scroll left and review past data points that have moved off the graph. You can then scroll right to return to the most recent data.

Note: The graph is updated each time the device is polled. You can change the polling interval (the frequency for collecting the data) by selecting and using the Preferences window.

### Trends

The graph on this tab is about past bandwidth utilization. Therefore, you see historical data when you open this tab-by default, the device's bandwidth data for the past 60 seconds. By clicking the trend buttons on the tab, you can also see data for the past 60 minutes, 24 hours, or 14 days. The data always appears as a bar graph. The intervals on the x-axis are fixed for each trend graph; you can lengthen or shorten them only by clicking a different trend button.

## Link Graphs

Link Graphs are available for Cisco ESW500 Series switches and CE520 switches only.

To display a link graph, one end of the link must connect to a port on a member device. You cannot display a link graph between candidate devices.

To display a link graph, take either of these actions:

- Choose **Monitor > Network > Link Graphs** on the feature bar.
- Click a link in the topology view and choose **Link Graphs** from the popup menu.

**NOTE** You can change the graph polling interval by selecting and using the Preferences window.

### Overview

A link graph shows the:

- Percentage of bandwidth being used
- Number of bytes transmitted and received
- Number of packets transmitted and received (differentiated into broadcast/multicast packets and unicast packets)



- Total errors and packets dropped

From the Link Graphs window, you can:

- **Select the Type of Data Displayed**
- **Select the Type of Graph Displayed**
- **Change the Increments on the Axes**
- **View a Long Span of Data**

### Procedures

To select a port other than the one in the **Interface** field, overwrite the port number, use the scroll buttons, or click the port selection icon. If you choose the last option, the Select Interface window opens to show the front panel of the device. Select a port by clicking it; then click **OK**. See [Select Interface, page 539](#).

### Select the Type of Data Displayed

To select a type of data, click % **Utilization**, **Transmitted/Received Packets**, **Packet-Forwarding Methods**, or **Packet Drops and Errors** in the **Data** list. The results of each selection are described in this table:

Data Type	Results
<b>% Utilization</b>	Displays the percentage of bandwidth being used on the port that corresponds to the link. For example, if the bandwidth of the link is 100 Mbps, and 20 Mb is consumed at a time, the graph plots 20% at that instant.
<b>Transmitted/Received Packets</b>	<p>Displays two graphs: Transmitted (red) and Received (blue).</p> <p>The Bytes Transmitted graph displays the number of bytes transmitted on the port that corresponds to the link.</p> <p>The Bytes Received graph displays the total number of bytes received on the port that corresponds to the link.</p>

Data Type	Results
<b>Packet-Forwarding Methods</b>	<p>Displays two graphs: Broadcast/Multicast Packets (red) and Unicast Packets (blue).</p> <p>The Broadcast/Multicast Packets graph displays the number of broadcast and multicast packets received on and transmitted to the port that corresponds to the link.</p> <p>The Unicast Packets graph displays the number of unicast packets received on and transmitted to the port that corresponds to the link.</p>
<b>Packet Drops and Errors</b>	<p>Displays two graphs: Total Errors (blue) and Total Packets Dropped (red).</p> <p>The Total Errors graph displays the total number of packets with errors that have accumulated on the port since the counters were last reset.</p> <p>The Total Packets Dropped graph displays the total number of packets that were dropped on the port corresponding to the link. Packets are dropped because of a lack of buffers or bandwidth or because of user-configured packet filtering on the device.</p>

### Select the Type of Graph Displayed

From the **Type** list, click **Line**, **Bar**, **Stack Bar**, **Area**, or **Stack Area** to select a type of graph. The appearance of each type is described in this table.

Graph Type	Appearance
<b>Line</b>	Data points are connected by a line.
<b>Bar</b>	Data points are denoted by the height of bars.
<b>Stack Bar</b>	Multiple bar graphs, each of a different color, are stacked one upon another.
<b>Area</b>	Data points are connected by a line, and the area under the line is filled in.

---

Graph Type	Appearance
Stack Area	Multiple area graphs, each of a different color, are stacked one upon another.

---

### Change the Increments on the Axes

By default, the time increments on the x-axis are 2 minutes apart. To make them closer together or farther apart, click the **Zoom** buttons.

Check **Log Scaling** if you want the increments on the y-axis to scale upward logarithmically rather than arithmetically.

### View a Long Span of Data

Use the scroll bar at the bottom of the graph to scroll left and review past data points that have moved off the graph. You can then scroll right to return to the most recent data.

**NOTE** The graph is updated each time the device is polled. You can change the polling interval (the frequency for collecting the data) from the Preferences window.

### Select Interface

This window appears when you click a switchport icon in a Configuration Assistant window. It displays the front panel of a selected switch. Use the window to select an interface on the switch.

Follow these steps:

---

**STEP 1** Click on the interface you want to use.

Interfaces that you cannot select are grayed out.

**STEP 2** Click **OK**. You return to the Configuration Assistant window you were using, and the number of the selected interface appears in the Interface field.

---

## Wireless Usage

To view a wireless usage report, choose **Monitor > Network > Wireless Usage** from the feature bar.

Status information for wireless clients is only available for these devices:

- Cisco UC500 platforms and Cisco SR500 Series Secure Routers with an embedded access point
- Cisco AP521 autonomous access points
- Cisco AP541N Dual-band Single-radio access points

Wireless LAN controller status is not shown.

Choose a wireless device from the Hostname list menu.

The Wireless Usage report displays the following information for each connected client:

- MAC address
- Name
- IP address
- VLAN number
- SSID (secure site identifier)
- Key management type
- Encryption type
- Data rate, in Mbps
- Signal strength, in dBm, for clients connected to AP521 and built-in UC500 access points
- RSSI (received signal strength indication, for AP541N access points)

The RSSI indicates the RF (radio frequency) signal strength for clients connected to AP541N access points. A value from 1 to 100 is displayed.

- Packets in/out
- Bytes in/out

## T1/E1/BRI Status

If a T1/E1 or BRI interface is present on the system, choose **Monitor > Network > T1/E1/BRI Status** from the feature bar to view output of Cisco IOS commands such as **show isdn status** and **show controller** for bri, t1, or e1, depending on the available interfaces.

## DNS and Hosts

Choose **DNS and Hosts** to view the output of the **show hosts** command for the customer site. The output includes the DNS hostname and domain of the UC500 or SR500 and the IP addresses of the primary and secondary DNS servers.

## Security

To access s monitoring options for network security, choose **Monitor > Security** from the feature bar. Expert mode security reports are listed and described below.

These reports are text-based and are generated from Cisco IOS command output.

**NOTE** These reports are primarily intended to aid the Small Business Support Center (SBSC) in resolving issues with Cisco SBSC deployments. Expert knowledge of Cisco IOS and the command-line interface is required to effectively interpret the data presented in these reports.

Security Report	Description
<b>EZVPN Client and Server</b>	Displays output of <b>show crypto</b> commands for obtaining information about current IKE security associations, EasyVPN remote configuration, settings used by current SAs, active VPN sessions, and encryption accelerator statistics.
<b>Site-to-Site VPN Status</b>	Displays output of <b>show crypto</b> commands for obtaining current IKE security associations, active VPN sessions, settings used by current SAs, active VPN sessions, and encryption accelerator statistics.

Security Report	Description
SSL VPN Status	Displays output of <b>show tcp</b> and <b>show webvpn</b> commands for obtaining information about TCP connection endpoints, SSL VPN user sessions, and SSL VPN tunnel statistics.  To display SSL VPN user session information for a specific user, enter the username and click <b>Query</b> .
Firewall	Displays output of <b>show access-list</b> and <b>show ip inspect session</b> commands.
NAT	Displays output of <b>show ip nat</b> and <b>show ip route</b> commands for obtaining information about NAT statistics, IP routes, and NAT translations.
VPN Status	See <a href="#">VPN Status, page 542</a> .

## VPN Status

The VPN status window appears when you choose **Monitor > Security > VPN Status** from the feature bar.

### EasyVPN

From this tab, you can monitor the status of EasyVPN tunnels.

Choose a device to be reported from the Hostname list. The report entries are automatically populated.

VPN Status	Description
UP-ACTIVE	Up and active.
UP-IDLE	Up, but there is no activity.
UP-NO-IKE	Up, but there is no IKE (Internet Key Exchange).
DOWN-NEGOTIATING	Down, but the device is negotiating the connection.
DOWN	Down.

## SSL VPN

From this tab, you can monitor status of SSL (secure socket layer) VPN tunnels.

## Telephony

To access monitoring options for telephony features, choose **Monitor > Telephony** from the feature bar. Expert mode telephony reports are listed and described below.

These reports are text-based and are generated from Cisco IOS and CUE command output.

**NOTE** These reports are primarily intended to aid the Small Business Support Center (SBSC) in resolving issues with Cisco SBSC deployments. Expert knowledge of CUE, Cisco IOS, and the command-line interface is required to effectively interpret the data and output presented in these reports.

Telephony Report	Description
<p><b>Phones and Extensions</b></p>	<p><b>Phones.</b> Displays read-only internal configuration information and status for phones and extensions, including tag, MAC address, phone type, username, button assignment, phone template in use, IP address, phone load being used, and status.</p> <p><b>Extensions.</b> For each extension, displays the DN tag, internal extension number, line type, label, username, COR incoming, trunk type, and channel status. If configured, the intercom number and intercom label are also displayed. Intercom numbers begin with an alphabetic character (for example, A502).</p>
<p><b>Hunt Groups</b></p>	<p>Displays internal configuration information for hunt groups, including the tag, pilot number, type, members, timeout settings, and destination for No Answer Forward To.</p> <p><b>Search Groups by Member.</b> Enter an extension number or a series of numbers separated by a comma to find out which hunt group or groups an extension number belongs to.</p>

Telephony Report	Description
<b>Call Blast Groups</b>	<p>Displays internal configuration information for hunt groups, including the tag, pilot number, type, members, timeout settings, and destination for No Answer Forward To.</p> <p><b>Search Groups by Member.</b> Enter an extension number or a series of numbers separated by a comma to find out which call blast group or groups an extension number belongs to.</p> <p>Choose a group and click <b>View Configuration Summary</b> to display CLI summary information for the selected call blast group.</p>
<b>TFTP Server Files</b>	<p>Displays filename information for TFTP server files stored on the flash. If applicable, the name of the device that owns the file and the filename alias are also listed.</p>
<b>Dial Peers</b>	<p>Displays internal configuration information for POTS and VoIP dial peers configured on the system.</p> <p><b>POTS.</b> For POTS dial peers, the information includes the tag number, port, description, destination pattern, incoming destination, translation profile name, forward-digits value, and trunk preference.</p> <p><b>VoIP.</b> For VoIP dial peers, the information includes the tag number, description, destination pattern, voice class, session target, DTMF relay, and codec.</p>
<b>Translation Profiles</b>	<p>Displays internal configuration information for translation profiles and translation rules and provides an option for testing translation rules.</p>
<b>SIP Trunk Status</b>	<p>Displays output of <b>show sip-ua</b> commands for SIP service status, registration, timers, and statistics.</p>
<b>Phone Template</b>	<p>For the selected IP phone template, displays internal template properties for softkeys and button layout.</p> <p>This information is read-only; templates cannot be edited using Configuration Assistant.</p>



Telephony Report	Description
<p><b>Voicemail Status</b></p>	<p>When you select a voicemail status report, Configuration Assistant displays a Progress dialog as the connection to the Voicemail system on the CUE module is opened and command output is collected. These text-based voicemail status reports are available:</p> <p><b>System.</b> Displays the output of show commands for obtaining information about clock and time zone statistics, privileges assigned to configured groups, versions of software and applications, purchased licenses for the system, and installed software packages.</p> <p><b>Voicemail.</b> Displays the output of show voicemail commands for obtaining information about configured mailboxes and current storage status, default values for all mailboxes, and voicemail usage statistics.</p> <p><b>Calendar.</b> Displays schedules and holidays configured for the system in text format.</p> <p><b>Others.</b> Displays the output of commands for obtaining information about currently configured applications, configured auto-attendant greeting prompts, script filenames, and currently configured trigger types.</p>
<p><b>DSP Status</b></p>	<p>The DSP Status report displays detailed show command output for DSP hardware, DSP farm, groups, errors, and active/signaling voice DSP.</p>
<p><b>Software Pack</b></p>	<p>The Software Pack report displays software package and component version information, compact flash usage, CUE status, and supported phone types for the currently installed UC500 software package.</p> <p>Version information for UC500 software packages prior to 7.0.0 is not available.</p>
<p><b>Extension Mobility Status</b></p>	<p>The Extension Mobility Status report displays Extension Mobility Phones, Extension Mobility Status output, Phone Profile and Current User Profile information. This information is read-only; to configure these settings see <a href="#">Extension Mobility, page 317</a>.</p>

---

## Inventory

To display an inventory report for a customer site or a single device, choose **Maintenance > Inventory**.

The inventory report for a customer site displays device types, serial numbers, IP addresses, and software releases for the site. You can also choose a single device for which you want to view inventory details.

The information in this window is read-only. For each device in the customer site, the inventory contains

- Hostname
- Device type
- Serial number
- Hardware version number (Version ID)
- MAC address
- IP address
- Installed software revision
- System location
- System uptime (length of time that it has been operating)

If you did not assign a hostname to a switch in the site, a hostname of **switch-*<number>*** is automatically assigned. The number shows the order in which the switch was added to the site.

Click **Details** to view details for a specific device. See [Inventory Details, page 547](#).

Click **Refresh** to update the display.

## Inventory Details

This window appears when you select a device with routing capability and click **Details** in the Inventory window.

The window displays information for the device by component, description, part number, hardware revision, PCB (printed circuit board) serial number, and product number. The description gives the details of the component. The part number is the order number of the component.

If you know that a change has occurred and you want to see the change, click **Refresh**. Configuration Assistant re-samples the components and redisplay the details when components are removed or added.

## System Log

The System Log report displays the output of the **show log** command.

## Multisite Status

You must be directly connected to a LAN port on the UC500 or SR520-T1 secure router to view multisite status.

The Multisite Status report displays the output for the **show crypto session detail** Cisco IOS command. This command lists all active Virtual Private Network (VPN) sessions and the IKE (Internet Key Exchange) and IPsec SAs (security associations) for each VPN session.

See [Multisite Status Monitoring, page 465](#).

## Health

You can monitor a number of device health measurements to avoid downtime and to ensure that your network is running efficiently. The measurements tell you about the utilization of bandwidth, PoE (Power over Ethernet), the CPU, and memory, and about device temperature and the percentage of packet errors.

To check the health measurements, choose **Monitor > Health** from the feature bar.

In addition to the health measurements, Configuration Assistant has features that focus on the use of specific resources:

- For information about PoE utilization, choose **Configure > Ports > Port Settings**.
- For information about bandwidth utilization over time, choose **Monitor > Network > Bandwidth Graphs**.
- For information about link utilization over time, choose **Monitor > Network > Link Graphs**.
- For more information about packet errors, choose **Monitor > Network > Port Statistics**.

Use the window to see up to five devices that have the highest measurements in the categories that you choose to monitor. Click the bars in the window to display additional.

For even more information, click **Details** to open the Health Details window. See [Health Details, page 548](#).

## Health Details

This window appears when you click **Details** in the System Health window (**Monitor > Health**). For a graphical display of this information, choose **Home > Dashboard**.

When you finish with the window, click **OK**.

The Health Details window has these tabs:

- **Overview**
- **Bandwidth Utilization**
- **Packet Errors**
- **PoE Utilization**
- **Temperature**
- **CPU Utilization**
- **Memory Utilization**

## Overview

The Overview tab shows the overall measurements for each of the categories that you monitor on all the devices in the network to which the categories apply. This table explains the columns on the tab.

Column	Explanation
<b>Hostname</b>	The hostname of a standalone device or the hostnames of the devices in your community
<b>Bandwidth Utilization</b>	The average bandwidth used to receive and transmit packets as of the last polling interval
<b>Packet Errors</b>	The overall (input and output) percentage of packets in error
<b>PoE Utilization</b>	The percentage of PoE wattage in use
<b>Temperature</b>	The temperature in Celsius
<b>CPU Utilization</b>	The percentage of CPU utilization in the last 5 seconds
<b>Memory Utilization</b>	The percentage of memory being used

### Bandwidth Utilization

The Bandwidth Utilization tab shows the percentage of bandwidth being used to receive packets, the percentage to transmit packets, and the average of the two.

You can open the Bandwidth Graphs window to see how the bandwidth of a device is being used over time. The Link Graphs window shows which ports have the most traffic.

### Packet Errors

The Packet Errors tab shows the percentage of device input and output packets that are in error and an overall error percentage.

### PoE Utilization

For devices that support PoE (Power over Ethernet), the PoE Utilization tab shows the percentage of PoE wattage in use, the total wattage, used wattage, and available wattage. If you are adding access points and IP phones to your network, connect them to devices that show a low PoE utilization.

### Temperature

For devices that can measure temperature precisely, the Temperature tab shows, in Celsius, the current temperature, the overheating threshold, and the critical threshold. For other devices, you see that the temperature is OK, Normal, Faulty, or N/A, indicating that the precise current temperature, overheating threshold, and critical threshold are not sensed.

### CPU Utilization

The CPU Utilization tab shows, by device, the percentage of CPU capacity in use in the last 5 seconds, 1 minute, and 5 minutes.

### Memory Utilization

The Memory Utilization tab shows the percentage of memory in use and the number of total, used, and free megabytes.

## Event Notification

The Event Notification window appears when you take any of these actions:

- Click an event icon on the status bar or in the Topology view.
- Choose **Monitor > Event Notifications** the feature bar.
- Click the Event Notification icon on the toolbar.

### Overview

An event is a condition that Configuration Assistant detects and wants you to know about. These are examples of events:

- A high device temperature
- A device with a broken fan
- An administratively disabled port
- A port with a duplex mismatch
- A port that you can configure with Smartports
- A device in your network that is unknown
- VLAN conflicts

To make you aware of an event, Configuration Assistant displays a popup message. It also puts a clickable event icon on the status bar and in the Topology view, beside the device on which the event occurred. When your mouse pointer touches an event icon in the Topology view, you see a summary of the event.

The appearance of the icon depends on the type of the event. Event types differ by number; the smaller the type number, the greater the need to take action.

If Configuration Assistant detects multiple events, you see icons for all of them in the Topology view. On the status bar, you see the icon for only the most urgent event.

The Event Notification window gives you a full description of events that were detected in your network. You use the window to:

- Tell Configuration Assistant that you are aware of the event.
- Ask Configuration Assistant to take action, if possible.
- Turn off the Alert LED on switches.

### Procedures

The Events tab in the notification window is where you can view descriptions of all the events in your network, acknowledge your awareness of them, and use Configuration Assistant to resolve them (if possible)

To see a subset of event information, click **Filter**, and use the Notification Filter window. See [Notification Filter, page 552](#).

Click **OK** when you are done with the window.

This table explains the information on the tab.

Column	Explanation
<b>Type</b>	Denotes how urgent it is to resolve the event. The lower the type number, the more urgent the need to resolve it.
<b>Time</b>	The time when the event occurred.
<b>Event Description</b>	A brief description of what occurred. When you select an event, a longer description appears below the list of events.

Column	Explanation
<b>Resolvable</b>	<b>Yes</b> if Configuration Assistant can resolve the event, <b>No</b> if it cannot. You ask Configuration Assistant to resolve an event by highlighting it and clicking <b>Resolve</b> . Configuration Assistant then opens a window for resolving the event.
<b>Acknowledged</b>	Boxes that you check to show your awareness of events. If you click <b>Acknowledge All</b> , you acknowledge all the events at once. When an event is acknowledged, its event icon dims.
<b>Device</b>	The device involved in the event.

### Notification Filter

This window appears when you click **Filter** in the Event Notification window. Use it to limit the types of events that appear in that window.

Follow these steps:

- 
- STEP 1** Under **Types**, uncheck the boxes for the event types to be filtered out. Events of these types do not appear in the Event Notification window.
  - STEP 2** Click **Set Defaults** if any box is unchecked and you want all the boxes to be checked again.

Click **OK** when you finish with the window.

---

## System Messages

From the System Messages window you can view the messages issued by devices in a customer site.

To access the System Messages window, choose **Monitor > System Messages** from the feature bar.

### Procedures

Follow these steps to view and filter system messages.



- 
- STEP 1** From the Hostname list, select a device whose messages you want to view, or select **All Devices** to see the messages that are issued by all the devices in the community.
  - STEP 2** Click a column heading of the table to sort the messages according to your interest. By default the messages are sorted by severity.
  - STEP 3** To see details about a particular message, select its row in the table. The message details appear in the area below the table.
  - STEP 4** *Optional:* Click **Filter** to open the System Messages Filter window, where you can specify criteria for limiting the messages that appear. See [System Messages Filter, page 553](#).
  - STEP 5** *Optional:* Click **Save Report** to save the window contents in a file in comma-delimited format. The default filename has a time stamp to make it unique.
  - STEP 6** Click **OK** when you finish with the window.
- 

## System Messages Filter

This window appears when you click **Filter** in the System Messages window. Use it to limit the number of messages that appear in that window.

To filter system messages, follow these steps.

- 
- STEP 1** Under **Severity Levels**, uncheck the boxes for the severity levels to be filtered out. Messages with these severity levels do not appear in the System Messages window.
  - STEP 2** Click **Set Defaults** if any box is unchecked and you want all the boxes to be checked again.
- Click **OK** when you finish with the window.
-



# Troubleshooting

Configuration Assistant provides several tools for troubleshooting your system:

- **Circuit Diagnostics (T1 Loopback)**
- **Network Diagnostics**
- **Telephony Diagnostics**
- **CUE Connectivity Diagnostics**
- **Security Diagnostics**
- **Generic Debugs**
- **IOS Exec Commands**
- **CUE Exec Commands**
- **Generating a System Troubleshooting Log**
- **Links and Connectivity (CE520 Switches)**

## Circuit Diagnostics (T1 Loopback)

To access the T1 Loopback diagnostic tool for troubleshooting the T1 circuit, choose **Troubleshoot > Circuit Diagnostics > T1 Loopback**.

This diagnostic is only available on a UC500 with a T1 voice interface or an SR520-T1 router with a T1 WAN connection.

### Overview

Use the T1 Loopback diagnostic to perform a local or remote loopback test on a T1 circuit.

On UC500 platforms with a T1 interface, you can also perform a Bit Error-Rate Test (BERT). In order to initiate a BERT, the T1 connection must be up and a far-end loop must be present on the circuit. If it is not, BERT options are unavailable.

During normal operation, the BERT errors (last) field should remain at 0. If bit-rate errors are observed, contact the service provider or Telco who provides the T1 circuit.

The BERT diagnostic is not available for SR520-T1 platforms.

### Procedures

To perform a loopback diagnostic, follow these steps.

- 
- STEP 1** Select a host from the Hostname list.
- STEP 2** Choose the T1 interface. In most cases, only one interface is listed.
- STEP 3** Choose a **Loopback Type** from the drop-down list.

Available loopback types vary, depending on whether you are running the diagnostic on a UC500 platform or an SR520-T1 secure router and whether or not an FDL (Facilities Data Link) type is set.

On the UC500, these Loopback types are available:

- Diag
- Local Line
- Local Payload
- Remote IBOC
- Remote ESF Line (if the FDL Type is set to ansi, att, or both)
- Remote ESF Payload (if the FDL Type is set to ansi, att, or both)

On the SR520-T1, these loopback types are supported:

- Local
- Remote
- Payload

- STEP 4** Optionally, choose an FDL Type. Available types are **ansi (ANSI T1.403)**, **att (AT&T TR54016)**, **both**, or **none set**.

The FDL Type setting enables additional remote loop testing capabilities by sending out-of-band signaling information between sites connected over a T1 circuit.

**STEP 5** Click **Loop Up** create the loopback on the circuit.

The **Summary** message displayed above the output window indicates the loop status (looped at the local end, looped at the remote end, or no loop detected).

You can click **Clear Counters** to zero out and reset the test counters.

**STEP 6** To initiate a BERT while the loop is up, follow these steps.

- a. Choose a Pattern. Available options are **All 0's**, **All 1's**, **2^11-1**, **Alternating 0's and 1's**, **2^20 QRSS**, **0.151**, and **2^15-1 QRW**.
- b. Set the test interval, from 1 to 14400 minutes.
- c. Click **Start BERT Test**.
- d. Click **Abort Current BERT Test** to stop the test.

Click **Refresh** to refresh interface and BERT test data.

BERT data, when present, is always displayed at the top of the output window. BERT data remains in the output window until you click **Clear Counters**.

**STEP 7** Click **Loop Down** to remove the loop.

If the loop is still up when you close this window, you are prompted to remove any existing loops. You should remove the loops unless you need to leave the loop active for extended testing.

---

## Network Diagnostics

Configuration Assistant provides several diagnostic tools:

- **Ping**
- **Trace, page 559**
- **DHCP Bindings**
- **System Status**
- **WAN Debug Log (SR520-T1)**

## Ping

To access the Ping diagnostic, choose **Troubleshoot > Network Diagnostics > Ping** from the feature bar.

The ping diagnostic is a very common method for troubleshooting the accessibility of devices.

### Overview

It uses a series of Internet Control Message Protocol (ICMP) echo messages to determine:

- Whether a remote host is active or inactive
- The round-trip delay in communicating with the host
- Packet loss

The ping diagnostic first sends an echo request packet to an address, then waits for a reply. The ping is successful only if:

- The echo request gets to the destination, and
- The destination is able to get an echo reply back to the source within a predetermined time (called a timeout). The default value of this timeout is two seconds on Cisco routers.

### Procedures

To run a ping test, follow these steps.

---

**STEP 1** Choose a source interface (either the default WAN interface, or an internal interface/IP address).

To test site-to-site VPN connectivity, choose an internal interface such as VLAN1.

**STEP 2** Enter a destination IP address or hostname.

**STEP 3** Click **Go**.

---

The output of the ping command indicates whether the test was successful (> 50% packets transmitted) and the average, minimum, and maximum round trip times.

## Trace

To access the Trace diagnostic, choose **Troubleshoot > Network Diagnostics > Trace** from the feature bar.

### Overview

The trace diagnostic (based on the Cisco IOS traceroute command) allows you to determine the path a packet takes in order to get to a destination from a given source by returning the sequence of hops the packet has traversed.

The trace terminates when the:

- Destination responds
- Maximum TTL (time-to-live) count is exceeded
- Maximum number of hops (30) is reached
- Trace is cancelled

The results of the trace are displayed in a table. The output for each hop displays the hop counter, the IP address and hostname associated with that hop, and the average latency in milliseconds.

### Procedures

To run the trace diagnostic:

---

**STEP 1** Enter the destination hostname or IP address.

**STEP 2** Click **Go**.

---

## DHCP Bindings

To access DHCP diagnostics, choose **Troubleshoot > Network Diagnostics > DHCP Bindings** from the feature bar.

The DHCP Bindings diagnostic displays the dynamically assigned IP addresses on the system.

Manual bindings cannot be cleared. You can only clear automatic bindings.

The output displays the IP address, hardware address (MAC address), and lease expiration date/time.

---

## Procedures

---

**STEP 1** Choose one of these options:

- Click **Release Selected Binding** to clear the selected DHCP binding.
- Click **Release All Bindings** to clear all DHCP bindings.
- Click **Read Bindings** to refresh the list.

**STEP 2** Click **OK** to close the window.

---

## System Status

To view system status, choose **Troubleshoot > Network Diagnostics > System Status** from the feature bar. This information can also be viewed in the System Status window on the Dashboard (**Home > Dashboard**).

The System Status window displays this information for managed devices at the customer site:

- Hostname
- Device type
- WAN IP address
- Subnet mask
- Gateway
- DNS server IP addresses
- Cisco IOS version
- Uptime (time elapsed since last system reset)
- Timestamp of last update

## WAN Debug Log (SR520-T1)

The WAN Debug Log window appears when an SR520-T1 secure router is present in the customer site and you choose **Troubleshoot > Network Diagnostics > WAN Debug Log** from the feature bar.



---

## Overview

The WAN Debug Log feature enables you to capture Cisco IOS debug information while troubleshooting a T1 WAN connection issue for the SR520-T1 Secure Router. You can also use this tool to gather SR520-T1 WAN configuration and connection status data. The information is collected in text log files and bundled into a .zip archive file. The Cisco IOS debug facility and show commands are used to gather the information.



**CAUTION** Enabling collection of WAN debug information is resource-intensive and can significantly degrade performance. Only enable WAN debugging for short periods of time and avoid peak usage periods, if possible.

For this reason, all WAN debugging is disabled when you close the WAN Debug Log window or close Configuration Assistant. If Configuration Assistant closes unexpectedly, WAN debugging is disabled the next time Configuration Assistant is launched.

---

## Procedures

To generate a log of **show** command output only:

---

**STEP 1** In the WAN Debug Log window, click **Browse** and choose a log file directory.

**STEP 2** Click **Generate Troubleshooting Log**.

You do not have to choose any WAN debug options or enable debugging.

A text log file is created in the specified directory; no zip file is created. This log includes the output of WAN debug-related show commands. A progress bar displays while the log is generated.

**STEP 3** Click **OK** to close the window when the log is generated.

---

To enable debug, and collect both show command output and WAN debug data, follow these steps.

---

**STEP 1** In the WAN Debug log window, click **Browse** and choose a log file directory.

**STEP 2** Check the **T1** checkbox to collect T1 WAN debug information.

**STEP 3** Click **Apply Debug** to enable debugging.

**STEP 4** Reproduce the issue on your network.

**STEP 5** Click **Generate Troubleshooting Log**.

A .zip file is created in the specified log file directory. This log includes the output of WAN debug-related show commands and all of the WAN debug data. A progress bar displays while the log is generated.

**STEP 6** Click **OK** to close the window when the log is generated.

**STEP 7** Turn off (uncheck) all WAN debugging and click **OK** to close the window.

All WAN debugging is disabled automatically when you close the window.

## Telephony Diagnostics

Configuration Assistant provides these voice diagnostic tools:

- **Dialplan Test**
- **SIP Trunk Registration**
- **Voice Troubleshooting Log**
- **Phone Debug Log**
- **PCM Capture**
- **SCCP Analog Phones**

### Dialplan Test

To access dial plan test diagnostics, choose **Troubleshoot > Telephony Diagnostics > Dialplan Test** from the feature bar.

Use the Dialplan Test diagnostic tool to view how the dial plan routes inbound and outbound calls to and from the specified port or extension on the system. You can perform two types of dial plan tests:

- **Outbound Dial Plan Test**
- **Inbound Dial Plan Test**

**NOTE** Dial plan tests do not involve active calls.

### Outbound Dial Plan Test

The outbound dial plan test shows how outbound calls are handled by the outgoing dial plan.

The test checks the permissions for the source extension (user or shared line), the destination number translations, and the possible routes (the outgoing interfaces on the router) for the call.

Given a user extension and a destination number, the voice configuration on the router is examined and the following call data is displayed:

- Whether the call is allowed
- The actual number forwarded to destination
- All potential interfaces, along with their preference
- The outgoing interfaces shown in the test output include SIP trunks, if any are configured
- For a SIP trunk, the SIP server IP is displayed

To perform an outbound dial plan test, follow these steps.

---

**STEP 1** Click the Outbound tab in the Dial Plan Test window.

**STEP 2** Choose a **User/Shared Extension** from the drop-down list.

**STEP 3** Enter the destination number for the outbound call.

The destination number can be an internal extension number or an external number (local, long distance, or international). It can contain up to 20 digits.

For external numbers, the number specified must include all necessary access codes such as the PSTN access code for external calls, long distance access code, area code, country code (for example 011) or international dialing code.

**STEP 4** Click **Get Dial Plan Details**.

---

### Inbound Dial Plan Test

For incoming calls, given an analog FXO port or a DID number, the inbound dial plan test shows how the call is routed and basic information about the destination extension.

The output indicates whether a matching destination was found and displays the destination extension number and extension type (for example, user, analog phone).

To perform an inbound dial plan test, follow these steps.

- 
- STEP 1** Click the Inbound tab in the Dialplan Test window.
  - STEP 2** Select **Analog FXO Port** or enter a **DID Number** for the incoming call. The DID number is typically an E.164 format number, for example, 16905552222.
  - STEP 3** Click **Find Destination**.
- 

### SIP Trunk Registration

The SIP Trunk Registration window displays SIP registration information and provides diagnostic tools for troubleshooting SIP trunk registration problems. When SIP trunk registration fails, the voice system is down and users are not able make and/or receive calls over the trunk. To access this window, choose **Troubleshoot > Telephony Diagnostics > SIP Trunk Registration**.

For more information, see these topics:

- [SIP Registration Information](#)
- [SIP Registration Diagnostics \(Ping Registrar, Ping Proxy, Reset Registrar\)](#)

#### SIP Registration Information

The following SIP registration information is displayed:

- Whether or not the SIP trunk is enabled
- Name of the SIP trunk provider configured in the SIP Trunk window. This can be one of the CCA-supported providers or the generic SIP trunk provider.

- SIP registration model used for the selected SIP trunk provider. The registration model can be one of the following:
  - The service provider registers the main number for the Outgoing Caller ID.
  - The service provider registers all DIDs using the same username and password.
  - The service provider registers DIDs using different usernames and passwords. User credentials for each DID are entered under **Configure > Telephony > Trunks > SIP Trunk**.
  - The service provider does not register DIDs (registration is not required).
- IP address or hostname of the SIP registrar server, if configured in the SIP Trunk window
- IP address or hostname of the outbound SIP proxy server, if configured in the SIP Trunk window

### SIP Registration Diagnostics (Ping Registrar, Ping Proxy, Reset Registrar)

These SIP registration diagnostics are provided.

SIP Diagnostic	Description
<b>Ping Registrar</b>	Click <b>Ping Registrar</b> to check connectivity with the SIP Registrar server that is configured in the SIP Trunk Window.  Depending on the output returned by the ping test, this could indicate DNS hostname resolution failure, problems with network settings, firewall or ACL issues preventing traffic from reaching the server, or an unreachable host.
<b>Ping Proxy</b>	Click <b>Ping Proxy</b> to check connectivity with the outbound SIP proxy server configured in the SIP Trunk window.

SIP Diagnostic	Description
<b>Reset Registrar</b>	<p>When you click <b>Reset Registrar</b>, the following actions are taken:</p> <ul style="list-style-type: none"> <li>▪ CCA reconfigures and resets the SIP registrar server. When the registrar server is reset, the timers and retry counters for the SIP User Agent in Cisco Unified CME are reset. This also allows SIP registration to be restarted without resetting the UC500.</li> <li>▪ If a domain name is specified for the SIP registrar server, CCA reconfigures the internal voice source group and ACLs for the CBAC firewall on the UC500. This can resolve problems that occur if the IP address for the registrar server that is added to the ACLs at the time of configuration is different than the IP address of the registrar server at the time of registration.</li> </ul> <p>After you reset the registrar server and allow time for registration with the service provider, you can check SIP registration status by going to the SIP Trunk Status window (<b>Monitor &gt; Telephony &gt; SIP Trunk Status</b>). The registered status in the SIP Register panel of the window should display “yes” if the SIP trunk has registered successfully.</p> <p>The SIP trunk attempts to register immediately. However, depending on the provider, it may take several hours for calls to start going through again after the SIP trunk has successfully registered.</p>

## Voice Troubleshooting Log

The Voice Troubleshooting log feature enables you to capture Cisco IOS debug information while troubleshooting a specific scenario or issue. You can also use this tool to gather voice-related device configuration data and voice state data. The information is collected in text log files and bundled into a .zip archive file.

---

## Overview

The IOS debug facility and show commands are used to gather the information. You can specify one or more of these types of voice debug data to collect:

- Dial plan
- Voice ports
- IP phones (SCCP)
- VoIP (SIP)
- VoIP (H323)



---

**CAUTION** Enabling collection of voice debug information is resource-intensive and can significantly degrade performance. Only enable voice debugging for short periods of time and avoid peak usage periods, if possible.

For this reason, all voice debugging is disabled when you close the Voice Troubleshooting Log window. If Configuration Assistant closes unexpectedly, voice debugging is disabled the next time Configuration Assistant is launched.

---

## Procedures

To generate a log of show command output only:

---

**STEP 1** In the Voice Troubleshooting Log window, click **Browse** and choose a log file directory.

**STEP 2** Click **Generate Troubleshooting Log**.

You do not have to choose any voice debug options or enable debugging.

A text log file is created in the specified directory; no zip file is created. This log includes the output of voice-related show commands. A progress bar displays while the log is generated.

**STEP 3** Click **OK** to close the window when the log as been generated.

---

---

To enable debug, and collect both show command output and voice debug data:

- 
- STEP 1** In the Voice Troubleshooting log window, click **Browse** and choose a log file directory.
  - STEP 2** Select one or more types of voice debug data to collect.
  - STEP 3** Click **Apply Debug** to begin generating debug information.
  - STEP 4** Reproduce the issue on your network.
  - STEP 5** Click **Generate Troubleshooting Log**.

A .zip file is created in the specified log file directory. This log includes the output of voice-related show commands and all of the voice debug data. A progress bar displays while the log is generated.

- STEP 6** Click **OK** to close the window when the log is generated.
- STEP 7** Turn off (uncheck) all voice debugging and click **OK** to close the window.

All voice debugging is disabled automatically when you close the window.

---

## Phone Debug Log

The Phone Debug Log window appears when you choose **Troubleshoot > Telephony Diagnostics > Phone Debug Log**.

### Overview

The Phone Debug log feature enables you to capture Cisco IOS debug information while troubleshooting a scenario or issue on a specific phone or group of phones.

You can also use this tool to gather voice-related device configuration data and voice state data for the selected phone or phones. The information is collected in text log files and bundled into a .zip archive file.





---

**CAUTION** The Cisco IOS debug facility and show commands are used to gather the information. Enabling collection of phone debug information is resource-intensive and can significantly degrade performance. Only enable phone debugging for short periods of time and avoid peak usage periods, if possible.

For this reason, all phone debugging is disabled when you close the Phone Debug Log window. If Configuration Assistant closes unexpectedly, voice debugging is disabled the next time Configuration Assistant is launched.

---

### Procedures

To generate a log of show command output only:

---

**STEP 1** In the Phone Debug Log window, click **Browse** and choose a directory for the log file.

**STEP 2** Click **Generate Troubleshooting Log**.

You do not have to choose any phones or enable debugging.

A text log file is created in the specified directory; no zip file is created. This log includes the output of voice-related show commands. A progress bar displays while the log is generated.

**STEP 3** Click **OK** to close the window when the log as been generated.

---

To enable debug, and collect both show command output and voice debug data:

---

**STEP 1** In the Phone Debug Log window, check the **Enable** option for each phone you wish to include in the debug log. This

**STEP 2** Click **Browse** and choose a log file directory.

**STEP 3** Select one or more types of voice debug data to collect.

**STEP 4** Click **Apply Debug** to begin generating debug information.

**STEP 5** Reproduce the issue on your network.

**STEP 6** Click **Generate Troubleshooting Log**.

A .zip file is created in the specified log file directory. This log includes the output of voice-related show commands and all of the voice debug data. A progress bar displays while the log is generated.

- STEP 7** When the log is generated, turn off (uncheck) debugging for all phones and click **OK** to close the window.

All phone debugging is disabled automatically when you close the window.

---

## PCM Capture

The PCM Capture window appears when you choose **Troubleshoot > Telephony Diagnostics > PCM Capture**.

From this window, you can troubleshoot voice quality or audio issues by generating a PCM (pulse code modulation) capture for a specific voice port, as instructed by Cisco support.

Follow these steps to reproduce the problem call scenario.

---

- STEP 1** Make sure that there is enough room on the UC500 flash to create the PCM capture. To do this, choose **Home > Dashboard** and look at the Flash Usage window.
- STEP 2** Try to reproduce the problem call scenario.
- STEP 3** Once you have the call set up, examine the output in the **Active Call Table** and **Voice Port Call Status Summary** panels to determine the voice port for the PCM capture, as directed by Cisco Support.

The Active Call Table displays the output of the **show call active voice brief** command, and the Voice Port Call Status Summary displays the output of the **show voice call sum** command.

For example, if the output in the Active Call Table displays the following for the call set up between extension 201 and extension 209 and extension 201 is experiencing the problem, then voice port 50/0/10 would be used for the PCM capture.

```
1227 : 26 1118849120ms.1 +2710 pid:20006 Answer 201 active  
dur 00:00:06 tx:131/31280 rx:130/31200  
Tele 50/0/10 (26) [50/0/10.0] tx:2620/2620/0ms g711ulaw  
noise:0 acom:0 i/0:0/0 dBm
```

```
1227 : 27 1118849600ms.1 +2220 pid:20034 Originate 209 active  
dur 00:00:06 tx:130/31200 rx:130/31200  
Tele 50/0/18 (27) [50/0/18.0] tx:2600/2600/0ms g711ulaw  
noise:0 acom:0 i/0:0/0 dBm
```

**STEP 4** In the **Voice Port** field, enter the port identifier that you want to perform the capture on (for example, 50/0/10).

**STEP 5** Click **Begin**.

When you click **Begin**:

- CCA issues these commands to set the capture buffer and specify the destination file for the capture (the file pcm.dat on the UC500 flash).

```
voice hpi capture buffer 5000000  
voice hpi capture destination flash:pcm.dat
```

- The system begins writing PCM data to the file pcm.dat on the UC500 flash.

**STEP 6** When you are ready to stop the capture, click **End and Save**.

**STEP 7** Save the pcm.dat capture file.

After you save the file, it is removed from the flash. The size of the capture file varies, depending on the actions performed on the call.

---

## SCCP Analog Phones

The SCCP Analog Phone window appears when you choose **Troubleshoot > Telephony Diagnostics > SCCP Analog Phones**.

Feature access codes enable users of SCCP-controlled analog phones to be able to access certain phone features by dialing codes (for example, \*\*1 to set Call Forward All on the phone).

When the UC500 device is in factory default configuration, the voice initialization process removes the `stcapp` feature access-code command.

From this window you can enable or disable `stcapp` feature-access codes.

- When **Enable `stcapp` feature access codes** is unchecked, feature access codes are configured through the `fac` commands under `telephony-service` only. This is the recommended setting.
- When **Enable `stcapp` feature access codes** is checked, the `stcapp` `feature access-codes` command is configured in addition to the `fac` commands under `telephony-service`. However, enabling this setting results in conflicts among feature codes, since codes 5, 6, 7, and 8 are configured differently by these commands. The output of the following `show` commands illustrates the conflict.

```
UC_540# show stcapp feature codes
```

```
stcapp feature access-code
malicious call ID (MCID) ***
prefix **
call forward all **1
call forward cancel **2
pickup local group **3
pickup different group **4
meetme-conference **5
pickup direct **6
forward-to-voicemail **7
cancel call waiting **8
```

```
UC540# sh telephony-service fac
```

```
telephony-service fac standard
callfwd all **1
callfwd cancel **2
pickup local **3
pickup group **4
pickup direct **5
park **6
dnd **7
redial **8
```

## CUE Connectivity Diagnostics

The CUE Diagnostics window appears when you choose **Troubleshoot > CUE Diagnostics > CUE Connectivity Diagnostics**.

Before you run CUE diagnostics:

- Make sure that Telnet is enabled on the UC500. When using CCA, Telnet is always enabled.
- A firewall running on your PC can potentially block the connection between the CUE module on the UC500 and Configuration Assistant. You may need to temporarily disable the firewall or configure the firewall to permit access to the CUE module while performing CUE diagnostics.

The CUE Connectivity Diagnostics window provides tools for troubleshooting and diagnosing problems related to the CUE module on the UC500. The Cisco Unity Express (CUE) voice mail system and UC500 applications such as TimecardView reside on the CUE module on the UC500.

From this window, you can:

- Check connectivity between the PC running CCA and the CUE module and view the output of CUE exec mode commands in a console window
- Execute one or more of the following Recovery Tasks to put the module in a known state to resolve CUE issues (for example, continuous reboot or software upgrade failures):
  - Reload CUE
  - Change to boot loader mode
  - Boot CUE from image on UC500 flash
- Generate a CUE logs to troubleshoot low-level problems on the CUE module

To learn more about CUE diagnostic options, see these sections:

- [Checking Status, page 574](#)
- [Generating Logs, page 574](#)
- [Performing Recovery Tasks, page 575](#)

### Checking Status

When you click **Check Status**, CCA attempts to open a Telnet connection to the CUE module to check the general health of the module. Depending on the CUE module status, different output is displayed:

- If CUE is booting when this button is clicked, boot progress output is shown in the console.
- If CUE is up and in exec mode, the **show tech-support** command is issued and the output is shown in the console.
- If the CUE is in boot loader mode, the **show config** command is issued and the output, which includes config parameters, is shown in the console.
- If the CUE session cannot be established, the appropriate error message is displayed in the console.

### Generating Logs

The **Generate Logs** button is only enabled if CUE is up and is in exec or config mode.

When you click **Generate Logs**, CCA gathers debug information from the CUE module and creates a .zip archive containing all of the generated log files. These logs are collected:

- install.log
- syslog.log
- atrace\_save.log
- debug\_server.log
- sshd.log
- postgres.log
- klog.log
- messages.log
- shutdown\_installer.log

You are prompted to specify a default log directory for the .zip file.

## Performing Recovery Tasks

Choose a recovery tasks and click **OK**.



**CAUTION** You should only perform Recovery Tasks on the CUE module if instructed to by Cisco Support to address a specific issue.

A CUE reload can take from 10 to 15 minutes.

When performing CUE recovery tasks, voice mail, Auto Attendant, and telephony applications such as Cisco WebEx PhoneConnect and TimeCardView are unavailable.

Recovery Task	Description
<b>Reload CUE</b>	The CUE interface is reset and progress is shown as the CUE is booting up in the console.
<b>Put CUE in Bootloader</b>	This option attempts to put CUE in boot loader mode. This is useful for putting CUE into a known state so that you can examine the boot configuration and then attempt to boot CUE from the image in the CUE flash.
<b>Boot CUE form Image on Flash</b>	This option is only available if CUE is in boot loader mode. The image on the CUE flash is used to boot CUE, and progress is shown in the console.

---

## Security Diagnostics

Cisco Configuration Assistant provides these security diagnostic tools:

- [Firewall/NAT Debug Log](#)
- [VPN Debug Log](#)

### Firewall/NAT Debug Log

The Firewall/NAT Debug Log window appears when you choose **Troubleshoot > Security Diagnostics > Firewall/NAT Debug Log**.

#### Overview

The Firewall/NAT Debug Log feature enables you to capture Cisco IOS debug information while troubleshooting a security scenario or issue for the UC500 platform and SR500 Series secure routers. You can also use this tool to gather firewall and NAT (network address translation) configuration and status data. The information is collected in text log files and bundled into a .zip archive file.

The Cisco IOS debug facility and show commands are used to gather the information. You can specify one or more of these types of security-related debug data to collect:

- NAT
- Firewall
- URL filtering



---

**CAUTION** Enabling collection of security debug information is resource-intensive and can significantly degrade performance. Only enable security debugging for short periods of time and avoid peak usage periods, if possible.

For this reason, all security debugging is disabled when you close the Firewall/NAT Debug Log window or close Configuration Assistant. If Configuration Assistant closes unexpectedly, all debugging is disabled the next time Configuration Assistant is launched.

---



---

## Procedures

To generate a log of **show** command output only:

---

**STEP 1** In the Firewall/NAT Debug Log window, click **Browse** and choose a log file directory.

**STEP 2** Click **Generate Troubleshooting Log**.

You do not have to choose any firewall or NAT debug options or enable debugging.

A text log file is created in the specified directory; no zip file is created. This log includes the output of firewall and NAT-related show commands. A progress bar displays while the log is generated.

**STEP 3** Click **OK** to close the window when the log is generated.

---

To enable debug, and collect both show command output and security debug data:

---

**STEP 1** In the Firewall/NAT Debug log window, click **Browse** and choose a log file directory.

**STEP 2** Select the type of security debug data to collect.

**STEP 3** Click **Apply Debug** to begin generating debug information.

**STEP 4** Reproduce the issue on your network.

**STEP 5** Click **Generate Troubleshooting Log**.

A .zip file is created in the specified log file directory. This log includes the output of firewall and NAT-related show commands and all of the security debug data. A progress bar displays while the log is generated.

**STEP 6** Click **OK** to close the window when the log is generated.

**STEP 7** Turn off (uncheck) all firewall and NAT debugging and click **OK** to close the window.

All firewall and NAT debugging is disabled automatically when you close the window.

---

## VPN Debug Log

The VPN Debug Log window appears when you choose **Troubleshoot > Security Diagnostics > VPN Debug Log**.

### Overview

The VPN Debug Log feature enables you to capture Cisco IOS debug information while troubleshooting a VPN issue for the UC500 platform and SR500 Series secure routers. You can also use this tool to gather VPN configuration and status data. The information is collected in text log files and bundled into a .zip archive file.

The IOS debug facility and show commands are used to gather the information. You can specify one or more of these types of VPN-related debug data to collect:

- EZVPN
- Site-to-site VPN (IPsec)
- SSL VPN (Clientless)
- SSL VPN (Full Tunnel)

If SSL VPN (Full Tunnel) is selected, choose an ACL, then enter a Web VPN user name. The ACLs listed are the ones that are configured on the router.



**CAUTION** Enabling collection of VPN debug information is resource-intensive and can significantly degrade performance. Only enable VPN debugging for short periods of time and avoid peak usage periods, if possible.

All VPN debugging is disabled when you close the VPN Debug Log window or close Configuration Assistant. If Configuration Assistant closes unexpectedly, VPN debugging is disabled the next time Configuration Assistant is launched.

### Procedures

To generate a log of **show** command output only:

- STEP 1** In the VPN Debug Log window, click **Browse** and choose a log file directory.
- STEP 2** Click **Generate Troubleshooting Log**. You do not have to choose any VPN debug options or enable debugging.

---

A text log file is created in the specified directory; no zip file is created. This log includes the output of firewall and NAT-related show commands. A progress bar displays while the log is generated.

**STEP 3** Click **OK** to close the window when the log is generated.

---

To enable debug, and collect both show command output and VPN debug data:

---

**STEP 1** In the VPN Debug log window, click **Browse** and choose a log file directory. Select the type of VPN debug data to collect.

- EZVPN
- Site-to-site VPN (IPsec)
- SSL VPN (Clientless)
- SSL VPN (Full Tunnel). Choose an ACL (access list) from the drop-down menu or enter a Web VPN user name.

**STEP 2** Click **Apply Debug** to begin generating debug information.

**STEP 3** Reproduce the issue on your network.

**STEP 4** Click **Generate Troubleshooting Log**.

A .zip file is created in the specified log file directory. This log includes the output of VPN-related show commands and all of the security debug data. A progress bar displays while the log is generated.

**STEP 5** Click **OK** to close the window when the log is generated.

**STEP 6** Turn off (uncheck) all VPN debugging and click **OK** to close the window. All VPN debugging is disabled automatically when you close the window.

---

---

## Generic Debugs

The Generic Debugs window appears when you choose **Troubleshoot > Generic Debugs** from the feature bar.

For information about how to view additional command-based diagnostic information, see [IOS Exec Commands, page 581](#) and [CUE Exec Commands, page 581](#).

### Overview

From the Generic Debugs window, you can: enter one or more Cisco IOS debug commands, one per line, to execute on the device. Once the debug data is collected, you can view the debug output in your default text editor and save it to a file or search the output for specific information.

Certain resource-intensive debug commands are excluded from this window. Configuration Assistant displays a message if you enter any of these commands or if the command you enter is invalid.

The output is stored in a 5 MB ring buffer. When the amount of data exceeds 5 MB, the oldest data is overwritten with the newest data.

To collect generic debug information:

- 
- STEP 1** Enter IOS debug commands to execute on the device, one per line.
  - STEP 2** Click **Begin** to begin collecting information.
  - STEP 3** Reproduce the scenario or issue in the network.
  - STEP 4** Click **End** to stop collecting debug data.
  - STEP 5** Once you have collected the data, you can:
    - Click **Search** to search debug output in the output area of the window. The command window displays only the output of each command; it does not echo the commands as they are executed.
    - Click **Save and Show Debug Output** to view collected debug output in your default text editor and save it to a file.
    - Click **Clear List** to reset the debug command list and enter different commands or enter commands in a different order.

- 
- STEP 6** Click **OK** to close the window. All debugging is disabled when you close the window. If Configuration Assistant closes unexpectedly, all debugging is disabled the next time Configuration Assistant is launched.
- 

## IOS Exec Commands

To view output of IOS exec mode commands, choose **Troubleshoot > IOS Exec Commands**.

From the IOS Exec Command window, you can simultaneously display the output of up to four Cisco IOS exec mode commands. The commands can be selected from a list or entered manually.

- To display output for a single command, choose an Cisco IOS exec command from the list or manually enter the command, and click **Run**.
- To display output for multiple commands, choose the number of panels to display (1, 2, or 4). Enter or select each command and click **Run** to display the output in a new panel. If all panels are in use, the output for the next command that you run overwrites the output for the oldest command.
- Click **Clear Panels** to clear all open panels.
- Click **Refresh** to update the information displayed in each panel.
- To find text, listed within the opened panel(s), enter the desired text in the search field and click **Search**. Matching text will be highlighted for each opened panel.
- To save the display output data of the opened panel click **Save a Copy**. On the proceeding window enter the desired file name, select the desired destination folder on your PC, then click **Save**.

## CUE Exec Commands

To view output of CUE exec mode commands, choose **Troubleshoot > CUE Exec Commands**.

From the CUE Exec Command window, you can simultaneously display the output of up to four CUE exec mode commands. The commands can be selected from a list or entered manually.

- To display output for a single command, manually enter the command and click **Run**.
- To display output for multiple CUE exec mode commands, choose the number of panels to display (1, 2, or 4). Enter each command and click **Run** to display the output a new panel. If all panels are in use, the output for the next command that you run overwrites the output for the oldest command.
- Click **Clear Panels** to clear all open panels.
- Click **Refresh** to update the information displayed in each panel.

## Generating a System Troubleshooting Log

Perform these steps to collect troubleshooting information from within Configuration Assistant to assist the Cisco TAC in helping to resolve issues.

You can select either a UC500 or an SR500 as the device, if a customer site is configured.

- 
- STEP 1** From within CCA, select **Help > Support Information** from the menu at the top of the main window.
  - STEP 2** In the Support Information window, click **Troubleshooting Log**.
  - STEP 3** Click **Browse** and choose any folder on your PC for the log file directory.
  - STEP 4** In the Hostname field, select the UC500 or SR500 device in the community.
  - STEP 5** Click **Generate Log**.

Configuration Assistant collects the required log and configuration files required for troubleshooting.

This process can take up to 5 minutes. The log file is created in the folder specified in step 3.

- STEP 6** Attach this log file to your Cisco Technical Assistance Center (TAC) case for technical support.

---

The log filename and format is UC5x0\_ *MAC address* \_Date\_Time\_tac\_logs.zip.

---

## Links and Connectivity (CE520 Switches)

To test the links or connectivity problems in a system with a CE520 switch, choose Links and Connectivity from the feature bar.

### Overview

From the Links and Connectivity window, you can discover these types of issues in your network:

- No connectivity between a source device and a destination device.
- No cable or a faulty cable connected to the port.
- Mismatch in the port speed settings on a link.
- Network connectivity issues between two devices in the network, for example, a host and a server.



---

**NOTE** The connectivity test is only supported on copper Ethernet 10/100/1000 ports.

---

### Procedures

To test a link, follow these steps.

- 
- STEP 1** Select **Link (Service Disruptive)** from the **Test Type** list.
  - STEP 2** Select a hostname from the Hostname list.
  - STEP 3** Select an interface from the Interface list, or click the icon beside the Interface field, and select an interface on the device that is displayed.
  - STEP 4** Click **Start** to start the test.
- 

If there are any errors on the link, the error message description and the recommendation appear in the Results area. If there are no errors, a message stating that there are no errors is displayed.

---

To resolve a link problem, click the **Fix It** button. You can only fix a speed mismatch problem by using Configuration Assistant.

To test the network connectivity between two devices, you must provide the source IP address of one device and the destination IP address of the other device. The test results show whether there is connectivity between the devices.

To test the network connectivity between two devices:

- 
- STEP 1** Select **Connectivity** from the Test Type list.
  - STEP 2** In the **Source IP** address field, enter the source IP address of one of the devices.
  - STEP 3** In the **Destination IP** address field, enter the destination IP address of the other device.

Click **Start** to start the test. The message description and the recommendation appear in the Results area.

---





## Where to Go From Here

Cisco provides a wide range of resources to help you and your customer obtain the full benefits of Cisco Configuration Assistant and the Cisco Smart Business Communications System (SBCS).

<b>Cisco Configuration Assistant</b>	
Cisco Configuration Assistant Product Page	<a href="http://www.cisco.com/go/configassist">www.cisco.com/go/configassist</a>
Cisco Configuration Assistant Technical Documentation	<a href="http://www.cisco.com/en/US/products/ps7287/tsd_products_support_series_home.html">www.cisco.com/en/US/products/ps7287/tsd_products_support_series_home.html</a>
<i>Cisco Configuration Assistant Out-of-Band Configuration Guidelines</i>	<a href="http://www.cisco.com/en/US/partner/products/ps7287/prod_installation_guides_list.html">http://www.cisco.com/en/US/partner/products/ps7287/prod_installation_guides_list.html</a>
<b>Cisco Small Business</b>	
Cisco Partner Central for Small Business (Partner Login Required)	<a href="http://www.cisco.com/web/partners/sell/smb">www.cisco.com/web/partners/sell/smb</a>
Cisco Small Business Home	<a href="http://www.cisco.com/smb">www.cisco.com/smb</a>
<b>Cisco Small Business Support</b>	
Cisco Small Business Support Community	<a href="http://www.cisco.com/go/smallbizsupport">www.cisco.com/go/smallbizsupport</a>
Cisco Small Business Support and Resources	<a href="http://www.cisco.com/go/smallbizhelp">www.cisco.com/go/smallbizhelp</a>
Phone Support Contacts	<a href="http://www.cisco.com/en/US/support/tsd_cisco_small_business_support_center_contacts.html">www.cisco.com/en/US/support/tsd_cisco_small_business_support_center_contacts.html</a>
Cisco Small Business Firmware Downloads	<a href="http://www.cisco.com/go/smallbizfirmware">www.cisco.com/go/smallbizfirmware</a>  Select a link to download firmware for Cisco Small Business Products. No login is required.  Downloads for all other Cisco Small Business products, including Network Storage Systems, are available in the Download area on Cisco.com at <a href="http://www.cisco.com/go/software">www.cisco.com/go/software</a> (registration/login required).

<b>Cisco Smart Business Communications System and Components</b>	
Cisco UC500 software packages and localization files (Cisco.com Login Required)	<a href="http://www.cisco.com/go/uc500swpk">www.cisco.com/go/uc500swpk</a>
Cisco Smart Business Communications System	<a href="http://www.cisco.com/go/sbcsresources">www.cisco.com/go/sbcsresources</a>
Cisco Unified Communications 500 Series	<a href="http://www.cisco.com/go/uc500resources">www.cisco.com/go/uc500resources</a>
Cisco SPA500 Series IP Phone	<a href="http://www.cisco.com/go/spa500phones">www.cisco.com/go/spa500phones</a>
Cisco SPA300 Series IP Phones	<a href="http://www.cisco.com/go/300phones">www.cisco.com/go/300phones</a>
Cisco Unified IP Phones 7900 Series	<a href="http://www.cisco.com/en/US/products/hw/phones/ps379/">www.cisco.com/en/US/products/hw/phones/ps379/</a>
Cisco AP541N Access Point	<a href="http://www.cisco.com/go/ap500resources">www.cisco.com/go/ap500resources</a>
Cisco SA500 Security Appliance	<a href="http://www.cisco.com/go/sa500resources">www.cisco.com/go/sa500resources</a>
Cisco ESW500 Series Switches	<a href="http://www.cisco.com/go/esw500resources">www.cisco.com/go/esw500resources</a>
Cisco PVC2300 (Audio/PoE) and WVC2300 (Audio/Wireless-G) Business Internet Video Cameras	<a href="http://www.cisco.com/go/smallbizcameras">www.cisco.com/go/smallbizcameras</a>
Cisco Secure Router SR500 Series	<a href="http://www.cisco.com/go/sr500">www.cisco.com/go/sr500</a>
<i>Cisco Smart Business Communications System Feature Reference Guide</i>	<a href="http://www.cisco.com/en/US/partner/prod/collateral/voicesw/ps6882/ps10585/partner_reference_c07-557625-00.html">www.cisco.com/en/US/partner/prod/collateral/voicesw/ps6882/ps10585/partner_reference_c07-557625-00.html</a>
<b>License Notices</b>	
Open Source License Notices	<a href="http://www.cisco.com/go/osln">www.cisco.com/go/osln</a> The Open Source License Notice for CCA 3.0 is located on the CCA software download page on Cisco.com.

# Glossary

## A

<b>AAA</b>	Authentication, authorization and accounting. Pronounced “triple-A.”
<b>ABR</b>	Area border router. A router that is located on the border of one or more OSPF areas and that connects the areas to the backbone network. ABRs are considered to be members of both the OSPF backbone and the attached areas. Therefore, they maintain routing tables that describe both the backbone topology and the topology of the areas.
<b>access point</b>	A device that serves as a center point in a wireless network or as a connection point between wireless devices and a wired network. See also autonomous access point and LAP (lightweight access point).
<b>access port</b>	A port that carries the traffic of one virtual LAN (VLAN). Contrast with trunk port.
<b>access VLAN</b>	VLAN that is used by a switch for data traffic. See also native VLAN and voice VLAN.
<b>address aggregation</b>	A routing protocol feature that breaks major network addresses into aggregates representing numerically contiguous groups of addresses known as supernets. This feature automatically suppresses the advertisements of more specific networks on a chosen interface.
<b>advertising</b>	The router process of sending routing and service updates at intervals so that other routers can maintain a table of usable routes.
<b>address mask</b>	A bit combination used to describe which part of an address refers to the network or the subnet and which part refers to the host. See also IP address and subnet mask.
<b>administrative speed</b>	The speed of a link as specified by the administrator. If the administrator specifies auto as the speed, the actual speed is determined through auto-negotiation.

---

<b>AES</b>	Advanced Encryption Standard. A block cipher that can encrypt and decrypt data using keys of 128, 192, or 256 bit.
<b>AES CCMP</b>	Advanced Encryption Standard-Counter Mode with Cipher Block Chaining Message Authentication Code Protocol. An encryption protocol that uses AES. The CCMP algorithm produces a message integrity code that provides data origin authentication and data integrity for the wireless packet.
<b>AP manager interface</b>	An interface that is used for all Layer 3 communications between a WLAN controller and LAP (lightweight access points) after the access points have joined the WLAN controller.
<b>ARP</b>	Address resolution protocol. An Internet protocol that is used to map an IP address to a MAC address.
<b>area</b>	A group of adjacent routers that share OSPF link-state updates. It is identified by a number known as an area ID.
<b>ATM</b>	Autonomous transfer mode. The international standard for cell relay in which multiple service types (such as voice, video, or data) are conveyed in fixed-length (53-byte) cells. Fixed-length cells allow cell processing to occur in hardware, thereby reducing transit delays. ATM is designed to take advantage of high-speed transmission media, such as E3, SONET, and T3.
<b>auto-negotiation</b>	The ability of linked ports to determine each other's characteristics and to choose the best communication method.
<b>autonomous access point</b>	A fully featured standalone access point that does not require a WLAN controller to operate. Compare with LAP (lightweight access point).
<b>AWP</b>	Alternatively wired ports. Two physical ports that operate as a single logical port. Usually one port uses a fiber SFP connector and the other port uses a copper RJ-45 connector.

## B

<b>BOOTP</b>	Bootstrap protocol. The protocol used by a network node to determine the IP address of its Ethernet interfaces to affect network booting.
--------------	---

## C

<b>CAC</b>	Call Admission Control. A process of regulating voice quality by limiting the number of calls that can be active on a particular link at the same time. CAC does not guarantee a particular level of audio quality on the link, but it does allow you to regulate the amount of bandwidth consumed by active calls on the link.
<b>CAS</b>	Channel-associated signaling. The transmission of signaling information within the voice channel. CAS signaling often is referred to as robbed-bit signaling because user bandwidth is being robbed by the network for other purposes.
<b>CCKM</b>	Cisco Centralized Key Management. A protocol that supports time-sensitive applications such as wireless voice over IP (VoIP). CCKM uses a fast re-keying technique that enables clients to roam from one access point to another without going through the controller.
<b>CDP</b>	Cisco Discovery Protocol. A protocol that a device uses to advertise its existence to other devices and to receive information about other devices on the same LAN or on the remote side of a WAN.
<b>CEF</b>	Cisco Express Forwarding. An advanced Layer 3 switching technology for IP. CEF optimizes network performance and scalability for networks with large and dynamic traffic patterns, such as those associated with the Internet, web-based applications, and interactive sessions.
<b>CGMP</b>	Cisco Group Management Protocol. A protocol that reduces the flooding of IP multicast packets by limiting the transmission of these packets to clients that request them. End stations become clients by sending join messages to join a CGMP group; they send leave messages to leave the group.
<b>clientless mode</b>	Provides secure access to private web resources and access to web content.
<b>customer site</b>	A group of devices that is managed through the IP addresses of its members. Switches, routers, wireless access controllers, and autonomous access points can be members.

## D

<b>default gateway</b>	A node in a network that serves as both an exit point to another network and an entry point from another network.
<b>delay dial</b>	The originating end seizes the line and waits 200 ms to see if the far end is on-hook. If so, the originating end then outputs digits. If the far end is off-hook, the originating end waits until the far end is on-hook before outputting digits.
<b>destination-based forwarding</b>	The forwarding of a packet by a port group based on the packet's destination address. Contrast with source-based forwarding.
<b>DHCP</b>	Dynamic host configuration protocol. A mechanism for dynamically allocating IP addresses so that addresses can be reused when hosts no longer need them.
<b>DID</b>	Direct Inward Dial. A service offered by telephone companies that enables callers to dial directly to an extension on a Private Branch Exchange (PBX) or packet voice system without the assistance of an operator or automated call attendant. This service makes use of DID trunks, which forward only the last three to five digits of a phone number to the PBX or router/gateway.
<b>digest authentication</b>	A process for SIP trunks and phones that allows challenge of the identity of a SIP user agent (UA) when the UA sends a request. (A SIP user agent represents a device or application that originates a SIP message.)
<b>DMZ</b>	Demilitarized zone. A buffer zone between the Internet, and your private networks. It can be a public network typically used for Web, FTP, and email servers that are accessed by external clients on the Internet. Placing these public access servers on a separate isolated network provides an extra measure of security for an internal network.
<b>DNS</b>	Domain Name Service. An Internet service that translates domain names, which are composed of letters, into IP addresses, which are composed of numbers.
<b>domain name</b>	The familiar, easy-to-remember name of a host on the Internet that corresponds to its IP address.
<b>dynamic address</b>	A MAC address that is learned on a port. It is stored in the address table and lost when the switch reloads. The first MAC address that is learned when port security is enabled becomes a dynamic secure address. See also static address.
<b>dynamic routing</b>	Routing that adjusts automatically to network topology or traffic changes. Also called adaptive routing.

## E

<b>EANA</b>	Equal Access North American. One of four common forms of CAS signaling; the others are groundstart, loopstart, and E&M.
<b>EAP</b>	Extensible Authentication Protocol. An authentication method in which an access point assists a wireless client device and a RADIUS server to perform authentication and to derive a dynamic WEP key.
<b>EIGRP</b>	Enhanced Interior Gateway Routing Protocol. A Cisco version of IGRP that provides superior convergence properties and operating efficiency and combines the advantages of link-state protocols with those of distance-vector protocols.
<b>E&amp;M</b>	One of four common forms of CAS signaling; the others are loop start, ground start and EANA.
<b>endpoint</b>	A SIP terminal or gateway. An endpoint can call and be called. It generates and/or terminates the information stream.
<b>EtherChannel</b>	A group of Fast Ethernet or Gigabit Ethernet ports that acts as a single logical port for high-bandwidth connections between switches or between switches and servers. If a port within an EtherChannel fails, traffic previously carried over the failed port transfers to the remaining ports within the EtherChannel.
<b>Ethernet management port</b>	The Ethernet management port is a Layer 3-capable host port to which you can connect a PC. The Ethernet management port can be used instead of the switch console port for network management. This port should be used only to manage the switch. The Ethernet management port supports the Port settings and IP Address features in Cisco Configuration Assistant.
<b>EZVPN</b>	Easy VPN. A centralized VPN management solution based on the Cisco Unified Client Framework. A Cisco Easy VPN consists of two components: a Cisco Easy VPN remote client, and a Cisco Easy VPN server.

## F

<b>failover</b>	The transfer of responsibilities to a standby switch.
-----------------	---

---

<b>Fast Leave</b>	A multicast routing feature that speeds up the removal of a multicast group from a router. When a member leaves a group, Fast Leave searches for other members of the group (devices receiving IP multicast packets from a particular port on the switch). If there are no other members on the port, the switch removes the port from the group. If there are no other ports in the group, the switch notifies the routers connected to the VLAN to delete the entire group.
<b>firewall</b>	A router or access server, or several routers or access servers, designated as a buffer between any connected public networks and a private network. A firewall router uses access lists and other methods to ensure the security of the private network.
<b>FTP</b>	File Transfer Protocol. Part of the TCP/IP protocol stack, used for transferring files between hosts.

## G

<b>GBIC</b>	Gigabit Interface Converter. A transceiver that converts electric currents (digital highs and lows) to optical signals and optical signals to digital electric currents. The GBIC is typically used in fiber-optic and Ethernet systems as an interface for high-speed networking. The data transfer rate is 1 Gigabit per second (1 Gbps) or more.
<b>graph polling interval</b>	The frequency with which Configuration Assistant queries the members of a customer site to obtain device- and link-utilization data throughout the device group. This information is used to update link graphs and bandwidth graphs. See also health polling interval, LED polling interval, and network polling interval.
<b>GRE</b>	Generic Routing Encapsulation. A tunneling protocol that encapsulates a variety of protocol packet types inside IP tunnels, creating a virtual point-to-point connection to devices at remote points over an IP network. With this technology, GRE encapsulates the entire original packet with a standard IP header and GRE header before the IPsec process. Then, IPsec views the GRE packet as an unremarkable IP packet and performs encryption and authentication services, as dictated by the IKE negotiated parameters. Because GRE can carry multicast and broadcast traffic, it is possible to configure a routing protocol for virtual GRE tunnels. The routing protocol detects loss of connectivity and reroutes packets to the backup GRE tunnel, thus providing high resiliency.



**groundstart** One of four common forms of T1 CAS signaling. It is primarily an analog signal that can be used on FXS, FXO, or any analog port; the others are EANA, and E&M.

## H

**health polling interval** The frequency with which Configuration Assistant queries the devices in a customer site to obtain measurements of the utilization of device resources and device temperatures. See also graph polling interval, LED polling interval, and network polling interval.

**home network** The network on the server side of a VPN tunnel. For example, a guest at a hotel might connect a PC to the hotel network to download a file stored on a server physically located on the guest's corporate network. The connection is established from the hotel network through the Internet to the corporate network by using a VPN tunnel. In this example, the hotel network is the remote network and the corporate network is the home network.

**hunt group** Number of telephone lines that are associated together by the telephone company central office or a PBX system. When a call comes in to a hunt group, it cycles through the group of lines until it finds one that is not busy, then it rings that phone (or extension, if it is a PBX system).

**HSRP** Hot Standby Routing Protocol. A protocol that provides high network availability and transparent network topology changes. It creates a device group with a lead device that services all the packets sent to a hot standby address. The lead device is monitored by others in the group; if it fails, one of the other devices inherits the lead position and the hot standby address.

**HWIC** High-Speed WAN Interface Card. A wireless LAN interface card in the HWIC form-factor that provides integrated access point functionality in Cisco devices with routing capability.

## I

**ICMP** Internet Control Message Protocol. A network layer Internet protocol that reports errors and provides other information relevant to IP packet processing.

**IGMP** Internet Group Management Protocol. A protocol used between hosts and routers on the LAN to determine which multicast groups the hosts belong to.

---

<b>IGMP snooping</b>	The examination by a Layer 2 switch of some Layer 3 information in an IGMP packet sent from a host to a router. The switch determines from its findings whether to add or remove member ports.
<b>IGRP</b>	Interior Gateway Routing Protocol. An Interior Gateway Protocol that addresses issues associated with routing in large, heterogeneous networks.
<b>IKE</b>	Internet Key Exchange. A key management protocol standard used in conjunction with IPsec and other standards. IPsec can be configured without IKE, but IKE enhances IPsec by providing additional features, flexibility, and ease of configuration for the IPsec standard. IKE provides authentication of the IPsec peers, negotiates IPsec keys, and negotiates IPsec security associations.
<b>Immediate Leave</b>	A multicast routing feature that speeds up the removal of a multicast group from a router. When a member indicates that it wants to leave the group, Immediate Leave removes the member port from the group at once.
<b>immediate start</b>	The originating end seizes the line by going off-hook and, without waiting for a response, it begins to outpulse digits.
<b>inside interface</b>	The first interface that connects the device to your internal, trusted network protected by a security appliance.
<b>IP address</b>	A 32-bit address assigned to hosts using TCP/IP. It belongs to one of five classes (A, B, C, D, or E) and is written in four octets separated by periods (dotted decimal format). Each address consists of a network number, an optional subnetwork number, and a host number. The network and subnetwork numbers together are used for routing, and the host number is used to address an individual host within the network or subnetwork. A subnet mask is used to extract network and subnetwork information from the IP address.
<b>IP phone</b>	A full-featured telephone that provides voice communication over an IP network.
<b>IPsec</b>	A framework of open standards that provides data confidentiality, data integrity, and data authentication between participating peers. IPsec provides these security services at the IP layer. IPsec uses IKE to handle negotiation of protocols and algorithms based on local policy and to generate the encryption and authentication keys to be used by IPsec. IPsec can be used to protect one or more data flows between a pair of hosts, between a pair of security gateways, or between a security gateway and a host.
<b>ISL</b>	Inter-Switch Link. A Cisco-proprietary protocol that maintains VLAN information as traffic flows between switches and routers.

## K

**keysystem** A small-scale telephone system designed to handle telephone communications for a small office of 1 to 25 users. Keysystems can be either analog or digital. In a keysystem each phone is able to answer any incoming PSTN call on any line. When multiple calls are present within the system at the same time, each call is visible and can be directly selected by pressing the corresponding line button on an IP phone.

## L

**LACP** Link Aggregate Control Protocol. The protocol that supports the IEEE 802.3AD specification for bundling physical interfaces together to form a single logical interface.

**LED polling interval** The frequency with which Configuration Assistant polls the ports in a customer site and displays changes in the LED colors of ports. See also graph polling interval, health polling interval, and network polling interval.

**lightweight access point** An access point that cannot act independently of a WLAN controller. The WLAN controller manages the AP configurations and firmware. No individual configuration of these access points is necessary. They handle only real-time MAC functionality and leave non-realtime MAC functionality to be processed by the WLAN controller. This architecture is referred to as the *split MAC* architecture. Compare with autonomous access point.

**link state protocol** A type of routing protocol that maintains a map of the internetwork, allowing it to see alternate routes or parallel paths for load balancing. OSPF is an example of this protocol type. Contrast with distance-vector protocol.

**LEAP** Lightweight Extensible Authentication Protocol. An 802.1X authentication type for wireless LANs that supports strong mutual authentication between the client and a RADIUS server using a logon password as the shared secret. It provides dynamic per-user, per-session encryption keys.

**link-state protocol** A type of routing protocol that maintains a map of the internetwork, allowing it to see alternate routes or parallel paths for load balancing. OSPF is an example of this protocol type. Contrast with distance-vector protocol.

**local span** A SPAN session in which all the source and destination ports are on the same switch. Contrast with remote SPAN.

**loopstart** One of four common forms of T1 CAS signaling, but it is primarily an analog signal that can be used on FXS, FXO, or any analog port; the others are groundstart, EANA, and E&M.

## M

**MAC** Media Access Control. The lower of the two sublayers of the data link layer defined by the IEEE. The MAC sublayer determines access to shared media, such as whether token passing or contention is used.

**MAC address** The standardized data link layer address that is required for every port or device that connects to a LAN. Other devices in the network use these addresses to locate specific ports in the network and to create and update routing tables and data structures. MAC addresses are 6 bytes long and are controlled by the IEEE.

**management interface** The default interface for managing a device. Media Access Control. The lower of the two sublayers of the data link layer defined by the IEEE. The MAC sublayer determines access to shared media, such as whether token passing or contention is used.

**multicast routing** A routing technique that allows copies of a single packet to be passed to a selected subset of all possible destinations. Contrast with unicast routing.

**MWI server** The SIP MWI (message waiting indicator) server is a proxy server that relays SIP MWI messages.

## N

**NAT** Network Address Translation. A mechanism for reducing the need for globally unique IP addresses. NAT allows an organization with IP addresses that are not globally unique to connect to the Internet by translating those addresses into globally routable IP addresses.

**native VLAN** The VLAN that carries untagged packets from an IEEE 802.1Q trunk port. See also access VLAN and voice VLAN.

---

<b>network EAP</b>	An authentication method in which the access point assists a wireless client device and the RADIUS server to perform authentication and to derive a dynamic WEP key.
<b>network polling interval</b>	The frequency with which Configuration Assistant polls the members of a customer site to determine the status of the device group and the existence of new members. See also graph polling interval, health polling interval, and LED polling interval.
<b>network port</b>	A port to which the switch forwards all VLAN traffic with unknown destination addresses; this process helps to prevent flooding to all the ports in a VLAN.
<b>notification name</b>	The name of a collection of information that specifies types of system events and an email address to which notification of these events is sent.
<b>NTP</b>	Network time protocol. A protocol that ensures accurate local time-keeping with reference to radio and atomic clocks located on the Internet.

## O

<b>open authentication</b>	An authentication method that allows any device to authenticate and then attempts to communicate with the access point.
<b>open authentication with EAP</b>	An authentication method in which the access point forces all client devices to perform EAP authentication before they can join the network.
<b>OSPF</b>	Open Shortest Path First. A link-state protocol that imposes no limit on hop count, propagates routing changes instantaneously, supports variable-length subnet masks, and allows for load balancing based on the actual cost of the link. It also compartmentalizes networks into smaller regions called areas, which limits the traffic caused by link-state updates.
<b>outside interface</b>	The first interface, usually port 0, that connects to other untrusted networks outside the security appliance; a WAN or the Internet.

## P

<b>PAT</b>	Port address translation. Conserves addresses in the global address pool by allowing source ports in TCP connections or UDP conversations to be translated. Different local addresses then map to the same global address, with port translation providing the necessary uniqueness. Global pool addresses are always used before a PAT address is used.
<b>pickup group</b>	Allows administrators to associate pickup groups with individual IP phones, making it easier for phone users to answer, or pick up, a call that is ringing on a different extension or telephone number.
<b>PBX</b>	Private branch exchange. Digital or analog telephone switchboard located on the subscriber premises and used to connect private and public telephone networks.
<b>PKI</b>	public-key infrastructure. A system of certification authorities (CAs) and registration authorities (RAs) that provides support for the use of asymmetric key cryptography in data communication through such functions as certificate management, archive management, key management, and token management. Alternatively, any standard for the exchange of asymmetric keys. This type of exchange allows the recipient of a message to trust the signature in that message, and allows the sender of a message to encrypt it appropriately for the intended recipient. See key management.
<b>PPPoE</b>	Point-to-Point Protocol over Ethernet. PPP encapsulated in Ethernet frames. PPPoE enables hosts on an Ethernet network to connect to remote hosts through a broadband modem.
<b>PoE</b>	Power over Ethernet. A technology that provides power to connected devices through the data cables rather than by power cords.
<b>polling interval</b>	See graph polling interval, LED polling interval, and network polling interval.
<b>preshared key</b>	An authentication method offered in IPsec. Preshared keys allow for one or more clients to use individual shared secrets to authenticate encrypted tunnels to a gateway using IKE (Internet Key Exchange). Preshared keys are commonly used in small networks of up to 10 clients. With preshared keys, there is no need to involve a certification authority for security.
<b>privilege level</b>	A number that determines the level of Configuration Assistant access that is granted to a user. Level 15 grants read-write access; levels 1 to 14 grant read-only access.

**PSTN** Public switched telephone network. General term referring to the variety of telephone networks and services in place worldwide.

## Q

**QoS** Quality of Service. Refers to the capability of a network to provide better service to selected network traffic. The primary goal of QoS is to provide priority including dedicated bandwidth, controlled jitter and latency (required by some real-time and interactive traffic), and improved loss characteristics.

## R

**RADIUS** Remote Authentication Dial-In User Service. A database for authenticating modem and ISDN connections and for tracking connection time.

**remote network** The network on the client side of a VPN tunnel. For example, a guest at a hotel might connect a PC to the hotel network to download a file stored on a server physically located on the guest's corporate network. The connection is established from the hotel network through the Internet to the corporate network by using a VPN tunnel. In this example, the hotel network is the remote network and the corporate network is the home network.

**remote span** A SPAN session in which the source ports are located remotely from the switch containing the destination port. Contrast with local SPAN.

**RIP** Routing Information Protocol. The most common Interior Gateway Protocol in the Internet. It uses a hop count as a routing metric.

**root port** The switch port with the best path to the root switch.

**root switch** The switch selected to be the center of a spanning-tree topology. All data flow across the network is from the perspective of this switch.

**routable interface** A routed port or an SVI.

**routing protocol** A set of rules and conventions for gathering information about available networks, such as the distance or cost to reach them, and determining the routing path for a packet.

## S

<b>secure address</b>	A MAC address that is forwarded to only one port per VLAN. Secure addresses are retained even when the switch reloads. See also dynamic address and static address.
<b>secure port</b>	A port for which a user-specified action occurs whenever an address-security violation occurs.
<b>SDP</b>	<ol style="list-style-type: none"><li>1. Session Description Protocol. A protocol for defining information needed to establish multimedia transport over IP. SDP transmits information such as session announcement, session invitation, transport addresses, and media types. For example, in a SIP call, SDP messages indicates if NTE is used, which events to send using NTE, and the NTE payload type value.</li><li>2. Secure Device Provisioning. Deploys PKI (public key infrastructure) between two end devices, such as a Cisco IOS client and a Cisco IOS certificate server.</li></ol>
<b>SFP</b>	Small form-factor pluggable. A field-replaceable laser optical transceiver module. SFP modules provide Gigabit uplink connections to other switches.
<b>SFTP</b>	SSH File Transfer Protocol. SFTP is part of SSH and is always enabled on the router. A user with the appropriate level can copy files to and from the router by using SFTP.
<b>shared authentication</b>	An authentication method in which the access point sends an unencrypted challenge text string to any device attempting to communicate with it. If the challenge text is correctly encrypted, the access point allows the requesting device to authenticate.
<b>SIP</b>	Session Initiation Protocol. Enables call handling sessions, particularly two-party audio conferences. SIP works with Session Description Protocol (SDP) for call signaling. Using SIP, the router can support any SIP Voice over IP (VoIP) gateways and VoIP proxy servers.
<b>SMTP</b>	Simple Mail Transfer Protocol. An Internet protocol that provides email services.
<b>SNMP</b>	Simple Network Management Protocol. A protocol in TCP/IP networks that provides a means to monitor and control network devices and to manage configurations, statistics collection, performance, and security.
<b>source-based forwarding</b>	The forwarding of a packet by a port group based on the packet source address. Contrast with destination-based forwarding.



---

<b>split tunneling</b>	Split tunneling allows VPN clients to communicate locally unencrypted. Users send only that traffic which is destined for the home network across the tunnel. All other traffic, such as instant messaging, email, or casual Internet browsing, is sent out to the Internet by using the local LAN of the VPN Client.
<b>SPAN</b>	Switched Port Analyzer. A feature that is used to specify a set of ports (or VLANs) to be monitored. A copy of the traffic on these source ports is sent to a specified destination port. Typically, a user connects a network analyzer to the destination port to view the traffic on the source ports. See also local SPAN and remote SPAN.
<b>spanning tree protocol</b>	See STP.
<b>static secure address</b>	A manually configured secure address that is stored in the address table and added to the running configuration. See also dynamic address and sticky MAC address.
<b>SSH</b>	Secure Shell. An application running on top of a reliable transport layer, such as TCP/IP, that provides strong authentication and encryption capabilities.
<b>SSID</b>	Service set identifier. A code attached to packets on a wireless network to identify each packet as part of that network. All wireless devices attempting to communicate with each other must associate with the same SSID.
<b>static route</b>	A route that is explicitly configured and entered into the routing table. Static routes take precedence over routes chosen by dynamic routing protocols.
<b>STP</b>	Spanning Tree Protocol. A standardized technique for maintaining a network of multiple bridges or switches. When a network topology changes, STP prevents the creation of loops by transparently reconfiguring bridges and switches and placing ports in a forwarding or blocking state. Each VLAN is treated as a separate bridge, and a separate instance of STP is applied to each.
<b>subnet mask</b>	A 32-bit address mask used in IP to show which bits of an IP address identify the network number, the subnetwork number, and the node number.
<b>switch port</b>	A Layer 2-only interface that is associated with a physical port. It can be either an access port or a trunk port.
<b>SVI</b>	Switch virtual interface. A VLAN with an assigned IP address that Layer 3 devices use to access the VLAN. An SVI can be configured to route packets from one VLAN to another.

## T

<b>TCP</b>	Transmission Control Protocol. A connection-oriented transport layer protocol that provides reliable full duplex data-transmission. TCP is part of the TCP/IP protocol stack.
<b>TCP/IP</b>	The common name for a suite of protocols that support the construction of worldwide internetworks.
<b>Telnet</b>	A terminal emulation protocol for TCP/IP networks such as the Internet. Telnet is a common way to control web servers remotely.
<b>TFTP</b>	Trivial File Transfer Protocol. A simplified version of FTP that allows files to be transferred from one computer to another over a network, usually without the use of client authentication (for example, username and password).
<b>TKIP</b>	Temporal Key Integrity Protocol. An encryption that defends against an attack on WEP in which the intruder uses an unencrypted segment called the initialization vector (IV) in encrypted packets to calculate the WEP key.
<b>trunk port</b>	A port that carries the traffic of multiple VLANs. Contrast with access port.
<b>tunnel</b>	A virtual channel through a shared medium such as the Internet, used for the exchange of encapsulated data packets.

## U

<b>UDP</b>	User Datagram Protocol. A connectionless transport layer protocol in the TCP/IP stack. UDP is a simple protocol that exchanges datagrams without acknowledgments or guaranteed delivery, requiring that error processing and retransmission be handled by other protocols.
<b>unicast routing</b>	A routing technique that routes a packet to a single destination and uses a routing protocol to determine the path to that destination. Contrast with multicast routing.

## V

<b>virtual interface</b>	An interface that acts as the DHCP server placeholder for wireless clients that obtain their IP address from a DHCP server and that serves as the redirect address for the web authentication login window.
--------------------------	---

---

<b>VLAN</b>	Virtual LAN. A logical rather than a physical LAN comprising workgroups drawn together for business reasons or for a particular project, irrespective of each member's actual location.
<b>VPN</b>	virtual private network. The same network security and privacy over a public infrastructure as would be provided over a private network. VPNs enable IP traffic to travel securely over a public TCP/IP network by encrypting all traffic from one network to another. A VPN uses tunneling to encrypt all information at the IP level.
<b>VTP</b>	VLAN Trunking Protocol. A Layer 2 messaging protocol that maintains VLAN configuration consistency by managing the addition, deletion, and renaming of VLANs on a network-wide basis.
<b>VTP pruning</b>	The blocking of flooded broadcast, multicast, and unknown unicast traffic to VLANs on trunk ports that are included in the pruning-eligible list.
<b>voice VLAN</b>	A VLAN that is used by a switch for voice traffic from IP phones. See also access VLAN and native VLAN.

## W

<b>WEP</b>	Wired Equivalent Privacy. An encryption that scrambles the communication between the access point and client devices to keep communication private. Both the access point and the client device use the same WEP key to encrypt and unencrypt radio signals.
<b>wink start</b>	The originating end seizes the line by going off-hook. It waits for acknowledgement from the other end before outpulsing digits. This serves as an integrity check that identifies a malfunctioning trunk and allow the network to send a re-order tone to the calling party.
<b>WINS</b>	Windows Internet Naming Service. A Windows system that determines the IP address associated with a particular network computer.
<b>WMM</b>	Wireless Multimedia. A QoS enhancement for wireless LANs. WMM supports devices that meet the 802.11E QoS Basic Service Set (QBSS) standard. WMM enables differentiated services for voice, video, and best-effort data to allow voice traffic to be handled before other traffic on the network.

---

<b>WPA</b>	Wi-Fi Protected Access. A standards-based, interoperable security enhancement that increases the level of data protection and access control for wireless LAN systems. Using WPA key management, clients and the authentication server authenticate to each other by using an EAP authentication method, and the client and server generate a pair-wise master key (PMK). WPA uses TKIP for data protection and IEEE 802.1X for authenticated key management.
<b>WPA2</b>	Wi-Fi Protected Access 2. A standards-based, interoperable security enhancement that uses AES CCMP for data protection. WPA2 offers a higher level of security than WPA because AES offers stronger encryption than TKIP.
<b>WPA-PSK</b>	Wi-Fi Protected Access-Pre-shared key. An authentication method that supports WPA on a wireless LAN where IEEE 802.1X-based authentication is not available. A pre-shared key is configured on both the client and the access point.
<b>WPA2-PSK</b>	Wi-Fi Protected Access 2-Preshared key. An authentication method that supports WPA2 on a wireless LAN where IEEE 802.1X-based authentication is not available. A preshared key is configured on both the client and the access point.