

# Cisco UCS C245 M8 SFF Rack Server

A printed version of this document is only a copy and not necessarily the latest version. Refer to the following link for the latest released version:

<https://www.cisco.com/c/en/us/products/servers-unified-computing/ucs-c-series-rack-servers/datasheet-listing.html>



# CONTENTS

<b>OVERVIEW</b>	<b>3</b>
<b>DETAILED VIEWS</b>	<b>4</b>
Chassis Front View	4
Chassis Rear View	5
<b>BASE SERVER STANDARD CAPABILITIES and FEATURES</b>	<b>7</b>
<b>CONFIGURING the SERVER</b>	<b>9</b>
STEP 1 VERIFY SERVER SKU	10
STEP 2 SELECT RISER CARDS (REQUIRED)	11
STEP 3 SELECT CPU(s)	13
STEP 4 SELECT MEMORY	15
Memory configurations and mixing rules	17
STEP 5 SELECT DRIVE CONTROLLERS	19
RAID Volumes and Groups	19
STEP 6 SELECT DRIVES	22
STEP 7 SELECT OPTION CARD(s)	25
ORDER OPTIONAL PCIe OPTION CARD ACCESSORIES	28
STEP 8 ORDER GPU CARDS (OPTIONAL)	29
STEP 9 ORDER POWER SUPPLY	31
STEP 10 SELECT INPUT POWER CORD(s)	32
STEP 11 ORDER TOOL-LESS RAIL KIT AND OPTIONAL REVERSIBLE CABLE MANAGEMENT ARM	36
STEP 12 SELECT MANAGEMENT CONFIGURATION (OPTIONAL)	37
STEP 13 ORDER SECURITY DEVICES (OPTIONAL)	38
STEP 14 SELECT LOCKING SECURITY BEZEL (OPTIONAL)	39
STEP 15 ORDER M.2 SATA SSDs (OPTIONAL)	40
STEP 16 SELECT OPERATING SYSTEM AND VALUE-ADDED SOFTWARE	41
STEP 17 SELECT OPERATING SYSTEM MEDIA KIT	45
<b>SUPPLEMENTAL MATERIAL</b>	<b>46</b>
Chassis	46
Riser Card Configurations and Options	48
Riser 1A	48
Riser 1B	49
Riser 2A	50
Riser 3A	51
Riser 3B	52
Riser 3C	53
Riser 3D	54
Serial Port Details	55
KVM Cable	55
<b>REPLACING CPUs and HEATSINKS</b>	<b>56</b>
<b>UPGRADING or REPLACING MEMORY</b>	<b>57</b>
<b>TECHNICAL SPECIFICATIONS</b>	<b>59</b>
Dimensions and Weight	59
Power Specifications	61
Environmental Specifications	65
Compliance Requirements	66

## OVERVIEW

The UCS C245 M8 SFF server extends the capabilities of Cisco's Unified Computing System portfolio in a 2U form factor with the addition of the AMD CPUs, 12 DIMM slots per CPU for 4800 MT/s DDR5 DIMMs with individual DIMM capacity points up to 256 GB. The maximum memory capacity for 2 CPUs is 6 TB (for 24 x 256 GB DDR5 DIMMs). The Cisco UCS C245 M8 SFF server offers the following:

### CPU:

- Up to 2x 4<sup>th</sup> Generation AMD Processors with up to 128 cores per processors

### Memory:

- 24 DIMM slots (12 DIMMs per CPU socket), up to 4800 MT/s DDR5.
- Up to 6 TB of capacity.

The server provides one or two internal slot for one of the following:

- Cisco 24G Tri-mode RAID controller with cache backup to control SAS/SATA/NVMe drives

**mLOM:** The UCS C245 M8 SFF server has a single 1GBE management port. A modular LAN on motherboard (mLOM)/OC3.0 module provides up to two 100GBE ports. A connector on the front of the chassis provides KVM functionality.

The Cisco UCS C245 M8 server can be used standalone, or as part of the Cisco Unified Computing System, which unifies computing, networking, management, virtualization, and storage access into a single integrated architecture enabling end-to-end server visibility, management, and control in both bare metal and virtualized environments.

See [Figure 1 on page 3](#) for front and rear views of the UCS C245 M8 server.

**Figure 1 Cisco UCS C245 M8 SFF Rack Server**

24 Front drives are SAS/SATA/NVMe (up to 4 direct attach NVMe drives in front) and optionally 4 direct attach NVMe rear drives

Front View



Rear View (all slots shown unpopulated - see [Figure 3 on page 5](#) for details)

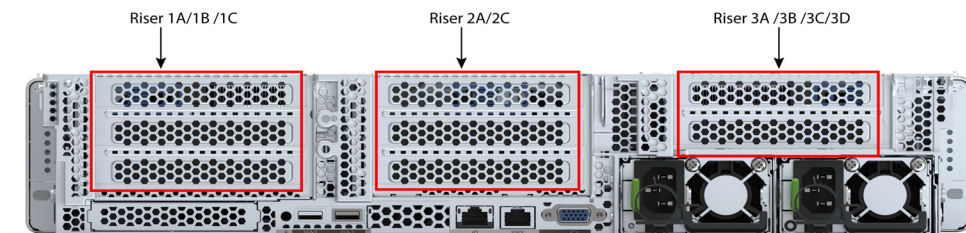

# DETAILED VIEWS

## Chassis Front View

Figure 2 shows the 24 Front drives are SAS/SATA/NVMe (up to 4 direct attach NVMe drives in front) and optionally 4 direct attach NVMe rear drives.

Figure 2 Chassis Front View (UCSC-C245-M8SX)

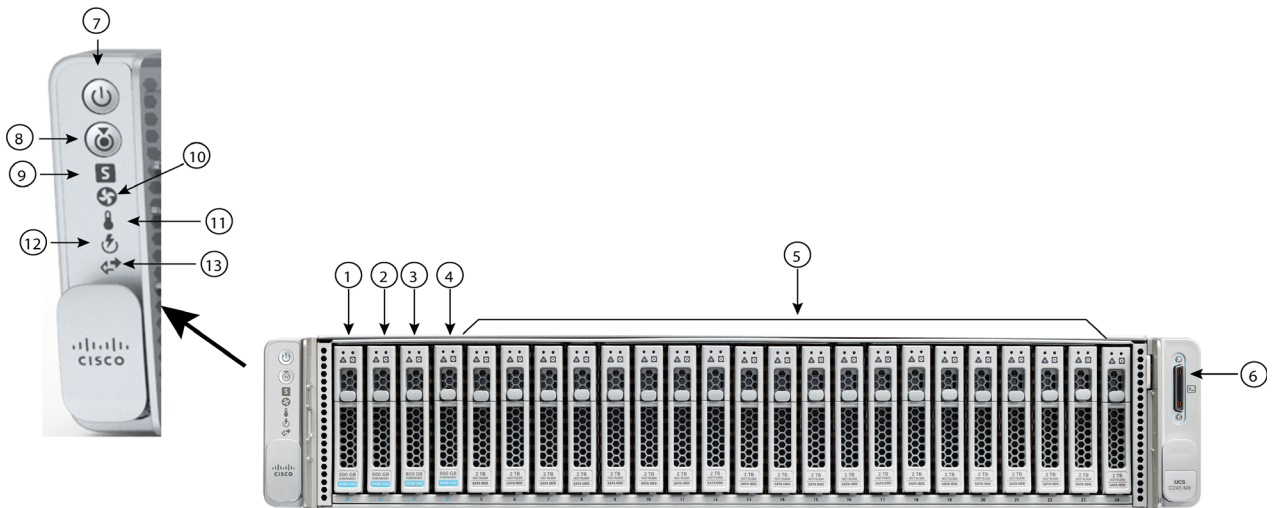

1 - 4	Up to 4 direct attach NVMe drives supports in front	9	System status LED
5	1-24 Support SAS/SATA/NVMe SSDs	10	Fan status LED
6	KVM connector (used with KVM cable that provides two USB 2.0, one VGA, and one serial connector)	11	Temperature status LED
7	Power button/Power status LED	12	Power supply status LED
8	Unit Identification button/LED	13	Network link activity LED

## Chassis Rear View

Figure 3 shows the external features of the rear panel.

Figure 3 Chassis Rear View (UCSC-C245-M8SX)

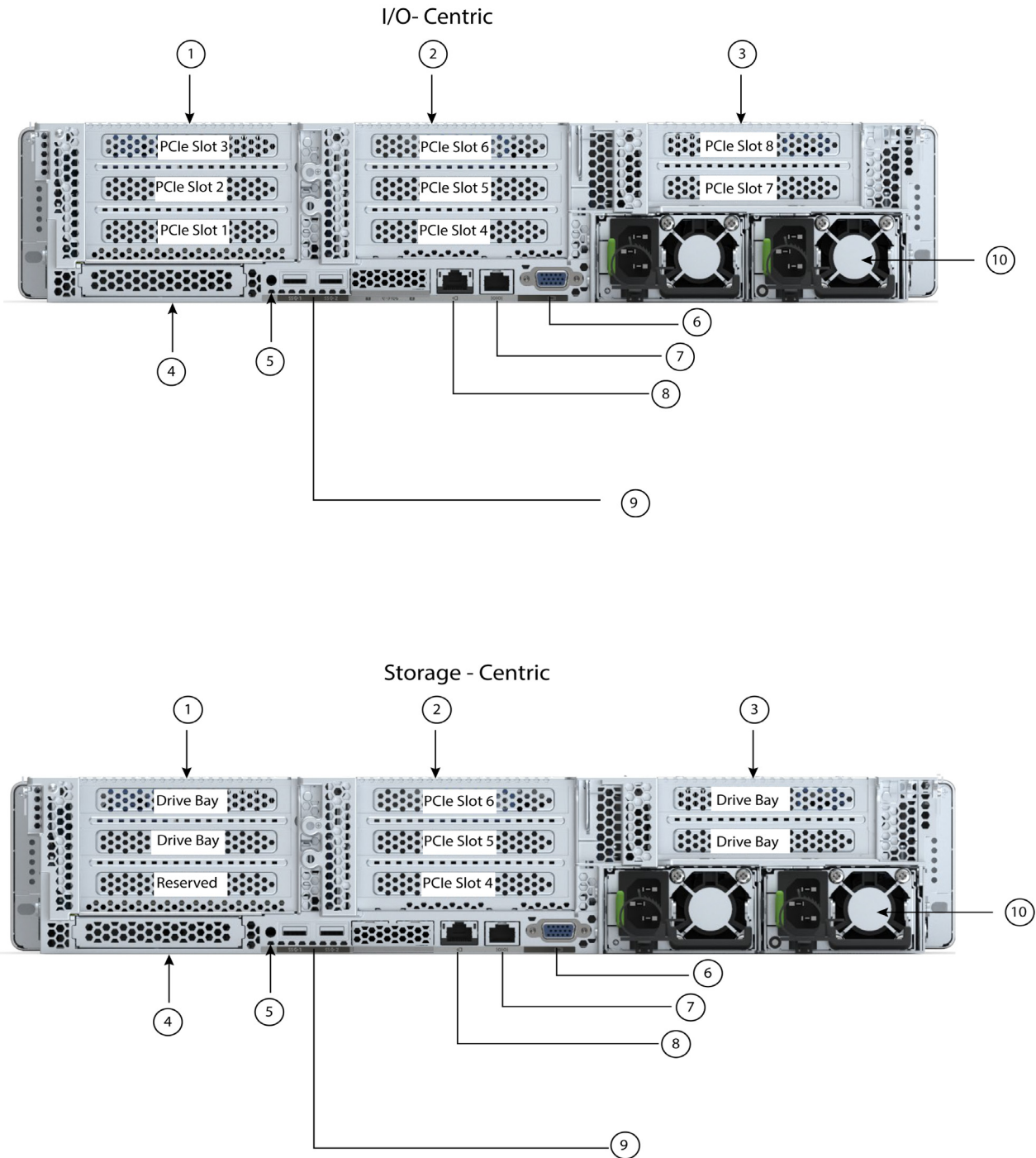

1	<p>There are three Riser 1 options:</p> <p><b>Riser 1A (I/O-centric, Gen 4, CPU1 control)</b> Supports three Gen 4 PCIe slots:</p> <ul style="list-style-type: none"> <li>■ Slot 1 is full-height, 3/4 length, x8, NCSI, single wide GPU</li> <li>■ Slot 2 is full-height, full-length, x16, NCSI, single/double wide GPU</li> <li>■ Slot 3 is full-height, full-length, x8, no NCSI, single wide GPU</li> </ul> <p><b>Riser 1B (storage-centric, CPU1 control)</b> Supports two drive bays:</p> <ul style="list-style-type: none"> <li>■ Slot 1 is reserved</li> <li>■ Drive bay 102, x4, SAS/SATA/NVMe</li> <li>■ Drive bay 101, x4, SAS/SATA/NVMe</li> </ul> <p><b>Riser 1C (I/O-centric, Gen 5, CPU1 control)</b> Supports two Gen 5 PCIe slots:</p> <ul style="list-style-type: none"> <li>■ Slot 1 is full-height, 3/4 length, x16, NCSI, single wide GPU</li> <li>■ Slot 2 is full-height, full-length, x16, no NCSI, single/double wide GPU</li> </ul>	6	VGA display port (DB15 connector)
2	<p>There are two Riser 2 options:</p> <p><b>Riser 2A (I/O-centric, Gen 4, CPU2 control)</b> Supports three Gen 4 PCIe slots:</p> <ul style="list-style-type: none"> <li>■ Slot 4 is full-height, 3/4 length, x8, NCSI, single wide GPU</li> <li>■ Slot 5 is full-height, full-length, x16, NCSI, single/double wide GPU</li> <li>■ Slot 6 is full-height, full length, x8, no NCSI, single wide GPU</li> </ul> <p><b>Riser 2C (I/O-centric, Gen 5, CPU2 control)</b> Supports two Gen 5 PCIe slots:</p> <ul style="list-style-type: none"> <li>■ Slot 4 is full-height, 3/4 length, x16, NCSI, single wide GPU</li> <li>■ Slot 5 is full-height, full-length, x16, no NCSI, single/double wide GPU</li> </ul>	7	COM port (RJ45 connector)
3	<p>There are three Riser 3 options</p> <p><b>Riser 3A (I/O-centric, CPU2 control)</b> Supports two PCIe slots:</p> <ul style="list-style-type: none"> <li>■ Slot 7 is full-height, full-length, x8, no NCSI, no GPU</li> <li>■ Slot 8 is full-height, full-length, x8, no NCSI, no GPU</li> </ul> <p><b>Riser 3B (storage-centric, CPU2 control)</b> Supports two drive bays:</p> <ul style="list-style-type: none"> <li>■ Drive bay 104, x4, SAS/SATA/NVMe</li> <li>■ Drive bay 103, x4, SAS/SATA/NVMe</li> </ul> <p><b>Riser 3C (for GPU, CPU2 control)</b> Supports one PCIe Slot:</p> <ul style="list-style-type: none"> <li>■ Slot 7 is one full-height, full-length, x16, no NCSI, double wide GPU</li> <li>■ Slot 8 is blocked by double wide GPU (not used)</li> </ul> <p><b>Riser 3D (storage-centric, CPU2 control)</b> Supports two drive bays:</p> <ul style="list-style-type: none"> <li>■ Drive bay 104, x4, SAS/SATA/NVMe</li> <li>■ Drive bay 103, x4, SAS/SATA/NVMe</li> </ul> <p><b>NOTE:</b> 3D Riser Supports Connectivity to 4x front NVMe SSDs at Gen4 x2 Per Drive</p>	8	1 GbE dedicated Ethernet management port
4	Modular LAN-on-motherboard (mLOM)/OCP 3.0 card slot (x16)	9	USB 3.0 ports (two)
5	System ID pushbutton/LED	10	Power supplies (two)

## BASE SERVER STANDARD CAPABILITIES and FEATURES

*Table 1* lists the capabilities and features of the base server. Details about how to configure the server for a particular feature or capability (for example, number of processors, disk drives, or amount of memory) are provided in *CONFIGURING the SERVER, page 9*.

**Table 1 Capabilities and Features**

Capability/Feature	Description
Chassis	Two rack unit (2RU) chassis
CPU	One or two AMD EPYC 97x4, 9004 Series, and 9004 Series with 3D V-Cache™ Technology Processors
Memory	24 slots for registered DIMMs (RDIMMs)
Multi-bit Error Protection	This server supports multi-bit error protection.
Video	The Cisco Integrated Management Controller (CIMC) provides video using the Matrox G200e video/graphics controller: <ul style="list-style-type: none"> <li>■ Integrated 2D graphics core with hardware acceleration</li> <li>■ Embedded DDR memory interface supports up to 512 MB of addressable memory (8 MB is allocated by default to video memory)</li> <li>■ Supports display resolutions up to 1920 x 1200 16bpp @ 60Hz</li> <li>■ High-speed integrated 24-bit RAMDAC</li> <li>■ Single lane PCI-Express host interface running at Gen 1 speed</li> </ul>
Power subsystem	Up to two of the following hot-swappable power supplies: <ul style="list-style-type: none"> <li>■ 1050 W (DC)</li> <li>■ 1200 W (AC)</li> <li>■ 1600 W (AC)</li> <li>■ 2300 W (AC)</li> </ul> One power supply is mandatory; one more can be added for 1 + 1 redundancy.
Front Panel	A front panel controller provides status indications and control buttons.
ACPI	This server supports the advanced configuration and power interface (ACPI) version 6.3
Fans	Six hot-swappable fans for front-to-rear cooling
Infiniband	The InfiniBand architecture is supported by the PCIe slots.
Expansion slots	<ul style="list-style-type: none"> <li>■ Riser 1A (three Gen 4 PCIe slots)</li> <li>■ Riser 1B (two drive bays)</li> <li>■ Riser 1C (two Gen 5 PCIe slots)</li> <li>■ Riser 2A (three Gen 4 PCIe slots)</li> <li>■ Riser 2C (two Gen 5 PCIe slots)</li> <li>■ Riser 3A (two Gen 4 PCIe slots)</li> <li>■ Riser 3B (two drive bays)</li> <li>■ Riser 3C (one full-length, double-wide GPU)</li> <li>■ Riser 3D (two drive bays)</li> </ul> For more details on the variations of riser 1, riser 2, and riser 3, see <i>Riser Card Configurations and Options, page 49</i> .

Capability/Feature	Description
Interfaces	<ul style="list-style-type: none"> <li>■ Rear panel                             <ul style="list-style-type: none"> <li>• One 1Gbase-T RJ-45 management port</li> <li>• One RS-232 serial port (RJ45 connector)</li> <li>• One DB15 VGA connector</li> <li>• Two USB 3.0 port connectors</li> <li>• One flexible modular LAN on motherboard (mLOM)/OCP 3.0 slot that can accommodate various interface cards.</li> </ul> </li> <li>■ Front panel                             <ul style="list-style-type: none"> <li>• One KVM console connector (supplies two USB 2.0 connectors, one VGA DB15 video connector, and one serial port (RS232) RJ45 connector)</li> </ul> </li> </ul>
Internal storage devices	<ul style="list-style-type: none"> <li>■ Up to 24 front facing SFF SAS/SATA HDDs or SAS/SATA SSDs or NVMe SSDs</li> <li>■ Optionally, up to four of the slots can be direct-attach NVMe. These drives must be placed in front drive bays 1, 2, 3, and 4 only. The rest of the bays (5 - 24) can be populated with SAS/SATA/NVMe SSDs or HDDs.</li> <li>■ Optionally, up to four SFF rear-facing SAS/SATA/NVMe drives</li> </ul>
	<p>Other storage:</p> <ul style="list-style-type: none"> <li>■ A mini-storage module connector on the motherboard supports a boot-optimized RAID controller carrier that holds up to two SATA M.2 SSDs. Mixing different capacity SATA M.2 SSDs is not supported.</li> <li>■ 8GB FlexMMC utility storage for staging of firmware and other user data. 8GB FlexMMC storage is built into the motherboard on M8</li> </ul>
Integrated management processor	<p>Baseboard Management Controller (BMC) running Cisco Integrated Management Controller (CIMC) firmware.</p> <p>Depending on your CIMC settings, the CIMC can be accessed through the 1GE dedicated management port or a Cisco virtual interface card (VIC).</p> <p>CIMC manages certain components within the server, such as the Cisco 12G SAS HBA.</p>
Storage controllers	<p><u>Internal storage controllers:</u></p> <ul style="list-style-type: none"> <li>■ Cisco 24G Tri-mode RAID controller                             <ul style="list-style-type: none"> <li>• RAID support (RAID 0, 1, 5, 6, 10, 50, 60, RAID0, and RAID00)</li> <li>• Supports up to 14 internal SAS/SATA/NVMe drives</li> </ul> </li> </ul> <p><u>External storage controllers:</u></p> <ul style="list-style-type: none"> <li>■ Cisco 12G 9500-8e 12G SAS HBA for external JBOD attach</li> </ul>
Modular LAN on Motherboard (mLOM)/Open Compute Project (OCP) 3.0 slot	<p>The dedicated mLOM/OCP 3.0 slot on the motherboard can flexibly accommodate the following cards:</p> <ul style="list-style-type: none"> <li>■ Cisco Virtual Interface Cards</li> <li>■ OCP 3.0 network interface card</li> </ul>
Fabric Interconnect	Compatible with the Cisco UCS 6454, 64108 and 6536 fabric interconnects
UCSM	UCS Manager (UCSM) 4.3(2) or later runs in the Fabric Interconnect and automatically discovers and provisions some of the server components.
Intersight	Intersight provides server management capabilities
CIMC	Cisco Integrated Management Controller 4.3(1) or later
Firmware standards	<ul style="list-style-type: none"> <li>■ UEFI Spec 2.9</li> <li>■ ACPI 6.5</li> <li>■ SMBIOS Ver 3.6</li> </ul>



# CONFIGURING the SERVER

Follow these steps to configure the Cisco UCS C245 M8 SFF Rack Server:

- [STEP 1 VERIFY SERVER SKU, page 10](#)
- [STEP 2 SELECT RISER CARDS \(REQUIRED\), page 11](#)
- [STEP 3 SELECT CPU\(s\), page 13](#)
- [STEP 4 SELECT MEMORY, page 15](#)
- [STEP 5 SELECT DRIVE CONTROLLERS, page 19](#)
- [STEP 6 SELECT DRIVES, page 22](#)
- [STEP 7 SELECT OPTION CARD\(s\), page 26](#)
- [STEP 8 ORDER GPU CARDS \(OPTIONAL\), page 30](#)
- [STEP 9 ORDER POWER SUPPLY, page 32](#)
- [STEP 10 SELECT INPUT POWER CORD\(s\), page 33](#)
- [STEP 11 ORDER TOOL-LESS RAIL KIT AND OPTIONAL REVERSIBLE CABLE MANAGEMENT ARM, page 37](#)
- [STEP 12 SELECT MANAGEMENT CONFIGURATION \(OPTIONAL\), page 38](#)
- [STEP 13 ORDER SECURITY DEVICES \(OPTIONAL\), page 39](#)
- [STEP 14 SELECT LOCKING SECURITY BEZEL \(OPTIONAL\), page 40](#)
- [STEP 15 ORDER M.2 SATA SSDs \(OPTIONAL\), page 41](#)
- [STEP 16 SELECT OPERATING SYSTEM AND VALUE-ADDED SOFTWARE, page 42](#)
- [STEP 17 SELECT OPERATING SYSTEM MEDIA KIT, page 46](#)

## STEP 1 VERIFY SERVER SKU

Top level ordering product ID (PID) is shown in [Table 2](#)

**Table 2 Top level ordering PID (major line bundle)**

Product ID (PID)	Description
UCS-M8-MLB	UCS M8 Rack, Blade, Chassis MLB This major line bundle (MLB) consists of the Rack Server (UCSC-C245-M8SX) with software PIDs. Use this PID to begin a new configuration.

Select server product ID (PID) from [Table 3](#).



**CAUTION:** This products may not be purchased outside of the approved bundles. (must be ordered under the MLB)

**Table 3 PID of the C245 M8 SFF Rack Base Server**

Product ID (PID)	Description
UCSC-C245-M8SX	Small form-factor (SFF) drives, with 24-drive backplane. <ul style="list-style-type: none"> <li>■ Front facing drive bays 1-24 support 2.5in SAS/SATA/NVMe SSDs depending on controller type installed.</li> <li>■ Optionally, front-loading drive bays 1, 2, 3, and 4 support 2.5-inch direct-attach NVMe SSDs.</li> <li>■ Optionally, 4 rear facing SAS/SATA/NVMe drives</li> </ul>

The Cisco UCS C245 M8 SFF server:

- Includes a 24-drive backplane
- Does not include power supply, CPU, memory DIMMs, hard disk drives (HDDs), solid-state drives (SSDs), NVMe drives, SD cards, riser 1, riser 2, riser 3, tool-less rail kit, or option cards.



**NOTE:** Use the steps on the following pages to configure the server with the components that you want to include.

## STEP 2 SELECT RISER CARDS (REQUIRED)

Select desired risers from [Table 4](#).



### CAUTION:

- Mixing storage riser and I/O Risers are not allowed with the exception of Riser 2
- Mixing Gen 4 and Gen 5 Risers are not allowed with the exception of Riser 3.

Table 4 PIDs of the Risers



Product ID (PID)	Description
<b>Option 1</b>	
UCSC-RIS1A-240-D (I/O riser, Gen 4)	C245 M8 Riser1A; (x8;x16x, x8); StBkt; (CPU1) (Gen4) <ul style="list-style-type: none"> <li>■ Slot 1 is full-height, 3/4 length, x8, Supports NCSI and single wide GPU</li> <li>■ Slot 2 is full-height, full-length, x16, Supports NCSI and single/double wide GPU</li> <li>■ Slot 3 is full-height, full-length, x8, Supports single wide GPU</li> </ul>  <p><b>Note:</b> This riser can only be select with UCSC-RIS2A-240-D, UCSC-RIS3A-240-D, UCSC-RIS3C-240-D.</p>
UCSC-RIS1B-245M8 (storage riser)	UCS C-Series M8 2U Riser 1B support rear SAS & NVMe Drives <ul style="list-style-type: none"> <li>■ Slot 1 is reserved</li> <li>■ Drive bay 102, x4, Supports SAS/SATA/NVMe drives</li> <li>■ Drive bay 101, x4, Supports SAS/SATA/NVMe drives</li> </ul>  <p><b>Note:</b> UCSC-RIS2A-240-D, UCSC-RIS2C-245M8, and UCSC-RIS3B-245M8.</p>
UCSC-RIS1C-245M8 (I/O riser, Gen 5)	UCS C-Series M8 2U Riser 1C PCIe Gen5 (2x16) <ul style="list-style-type: none"> <li>■ Slot 1 is full-height, 3/4 length, x16, Supports NCSI and single wide GPU</li> <li>■ Slot 2 is full-height, full-length, x16, supports single/double wide GPU</li> </ul>  <p><b>Note:</b> If Selected can only select with UCSC-RIS2C-245M8, UCSC-RIS3A-240-D, UCSC-RIS3C-240-D.</p>
<b>Option 2</b>	
UCSC-RIS2A-240-D (I/O riser, Gen 4)	C245 M8 Riser2A; (x8;x16;x8);StBkt; (CPU2) <ul style="list-style-type: none"> <li>■ Slot 4 is full-height, 3/4 length, x8, Supports NCSI and single wide GPU</li> <li>■ Slot 5 is full-height, full-length, x16, Supports NCSI and single/double wide GPU</li> <li>■ Slot 6 is full-height, full length, x8, Supports single wide GPU</li> </ul>
UCSC-RIS2C-245M8 (I/O riser, Gen 5)	UCS C-Series M8 2U Riser 2C PCIe Gen5 (2x16); (CPU2) <ul style="list-style-type: none"> <li>■ Slot 4 is full-height, 3/4 length, x16, Supports NCSI and single wide GPU</li> <li>■ Slot 5 is full-height, full-length, x16, Supports single/double wide GPU</li> </ul>

Table 4 PIDs of the Risers

Product ID (PID)	Description
<b>Option 3 (2-CPU must be selected)</b>	
UCSC-RIS3A-240-D (I/O riser, Gen 4)	C245 M8 Riser3A (x8;x8); StBkt; (CPU2) (GEN4) <ul style="list-style-type: none"> <li>■ Slot 7 is full-height, full-length, x8</li> <li>■ Slot 8 is full-height, full-length, x8</li> </ul>
UCSC-RIS3B-245M8 (storage riser, Gen 4)	UCS C-Series M8 2U Riser 3B support rear SAS & NVMe Drives (GEN 4) <ul style="list-style-type: none"> <li>■ Drive bay 104, x4, SAS/SATA/NVMe drives</li> <li>■ Drive bay 103, x4, SAS/SATA/NVMe drives</li> </ul>
UCSC-RIS3C-240-D (GPU riser)	C245 M8 Riser 3C (GEN4) <ul style="list-style-type: none"> <li>■ Slot 7 is one full-height, full-length, x16, Supports double wide GPU</li> <li>■ Slot 8 is blocked by double wide GPU (not used)</li> </ul>
UCSC-RIS3D-245M8 (storage riser, Gen 4)	UCS C-series M8 2U C245 Riser 3D (GEN 4) <ul style="list-style-type: none"> <li>■ Drive bay 104, x4, SAS/SATA/NVMe drives</li> <li>■ Drive bay 103, x4, SAS/SATA/NVMe drives</li> </ul> <p><b>NOTE:</b> 3D Riser Supports Connectivity to 4x front NVMe SSDs at Gen4 x2 Per Drive</p>
<p><b>Accessories/spare included along with selected risers:</b></p> <ul style="list-style-type: none"> <li>■ UCSC-FBRS2-C240-D for riser 2 and UCSC-FBRS3-C240-D riser filler blank for riser 3 is auto included, if riser 2 or riser 3 are not selected.</li> <li>■ CBL-SASR1B-C245M8 is auto included with selection of Riser 1B and Raid controller (UCSC-RAID-HP)</li> <li>■ CBL-SASR3B-C245M8 is auto included with selection of Riser 3B/3D and Raid controller (UCSC-RAID-HP)</li> <li>■ CBL-R3D-C245M8 is auto included with selection of Riser 3D (UCSC-RIS3D-245M8)</li> <li>■ CBL-SASR1-C245M8 is auto included with selection of Raid controller (UCSC-RAID-HP).</li> <li>■ CBL-SASR3-C245M8 is auto included with selection of Raid controller (UCSC-RAID-HP).</li> </ul> <p><b>NOTE:</b> Please note, if you are adding additional risers and raid controller later, you may need to order the accessories with it.</p>	



**NOTE:**

- For additional details on riser cards, see [Riser Card Configurations and Options, page 49](#)
- For GPU support on a particular riser slot, see [Table 15 on page 30](#)

## STEP 3 SELECT CPU(s)

The standard CPU features are:

- CPU-to-CPU communication using Infinity Fabric Interconnect
- Cache size of up to 1152 MB
- Up to 128 cores

### Select CPUs

The available CPUs are listed in [Table 5](#)



**CAUTION:** For systems configured with processors operating above 28° C [82.4° F], a fan fault or executing workloads with extensive use of heavy instructions sets may assert thermal and/or performance faults with an associated event recorded in the System Event Log (SEL).

Table 5 Available CPUs

Product ID (PID) <sup>1</sup>	Maximum Socket	Core	Clock Freq	Power	Cache Size	Highest DDR5 DIMM Clock Support
	(S)	(C)	(GHz)	(W)	(MB)	(MT/s) <sup>2</sup>
<b>4<sup>th</sup> Gen EPYC 97x4 Processors</b>						
UCS-CPU-A9754	2S	128	2.25	360	256	4800
UCS-CPU-A9734	2S	112	2.20	340	256	4800
<b>4<sup>th</sup> Gen EPYC 9004 Series Processor</b>						
UCS-CPU-A9654	2S	96	2.40	360	384	4800
UCS-CPU-A9634	2S	84	2.25	290	384	4800
UCS-CPU-A9554	2S	64	3.10	360	256	4800
UCS-CPU-A9534	2S	64	2.45	280	256	4800
UCS-CPU-A9454	2S	48	2.75	290	256	4800
UCS-CPU-A9354	2S	32	3.25	280	256	4800
UCS-CPU-A9334	2S	32	2.70	210	128	4800
UCS-CPU-A9254	2S	24	2.90	200	128	4800
UCS-CPU-A9224	2S	24	2.50	200	64	4800
UCS-CPU-A9124	2S	16	3.00	200	64	4800
UCS-CPU-A9474F	2S	48	3.60	360	256	4800
UCS-CPU-A9374F	2S	32	3.85	320	256	4800
UCS-CPU-A9274F	2S	24	4.05	320	256	4800
UCS-CPU-A9174F	2S	16	4.10	320	256	4800
UCS-CPU-A9654P	1S	96	2.40	360	384	4800
UCS-CPU-A9554P	1S	64	3.10	360	256	4800

Table 5 Available CPUs

Product ID (PID) <sup>1</sup>	Maximum Socket	Core	Clock Freq	Power	Cache Size	Highest DDR5 DIMM Clock Support
	(S)	(C)	(GHz)	(W)	(MB)	(MT/s) <sup>2</sup>
UCS-CPU-A9454P	1S	48	2.75	290	256	4800
UCS-CPU-A9354P	1S	32	3.25	280	256	4800
<b>4<sup>th</sup> Gen EPYC 9004 Series with 3D V-Cache™ Technology</b>						
UCS-CPU-A9684X	2S	96	2.55	400	1152	4800
UCS-CPU-A9384X	2S	32	3.10	320	768	4800
UCS-CPU-A9184X	2S	16	3.55	320	768	4800

Notes:

1. Any CPU PID ending in “P” cannot be used in a 2-CPU system. They can only be used in a 1-CPU system
2. If higher or lower speed DIMMs are selected than what is shown in [Table 7 on page 16](#) for a given CPU speed, the DIMMs will be clocked at the lowest common denominator of CPU clock and DIMM clock.

Approved Configurations

(1) For the UCSC-C245-M8SX:

- For 1-CPU systems, select one CPU from [Table 5 on page 13](#). The server is shipped by default with riser 1 only
- For 2-CPU systems, select two identical CPUs from [Table 5 on page 13](#).



NOTE:

- You cannot have two CPUs ending in a “P” suffix in a two-CPU configuration.
- If you configure a server with one CPU with a “P” suffix, you cannot later upgrade to a 2-CPU system with two of these CPUs.

Caveats

- The selection of 1 or 2 CPUs depends on the desired server functionality. See the following sections:
  - [STEP 4 SELECT MEMORY, page 15](#)
  - [STEP 5 SELECT DRIVE CONTROLLERS, page 19](#)
  - [STEP 6 SELECT DRIVES, page 22](#)
  - [STEP 7 SELECT OPTION CARD\(s\), page 26](#)

## STEP 4 SELECT MEMORY

The *Table 6* below describes the main memory DIMM features supported on Cisco UCS C245 M8 rack server.

Table 6 C245 M8 Main Memory Features

Memory DIMM server technologies	Description
DDR5 memory clock speed	4th Gen. CPU: Up to 4800 MT/s 1DPC
Operational voltage	1.1 Volts
DRAM fab density	16Gb and 24Gb
DRAM DIMM type	RDIMM (Registered DDR5 DIMM)
Memory DIMM organization	Twelve memory DIMM channels per CPU; 1 DIMMs per channel only
Maximum number of DRAM DIMM per server	Up to 24 (2-Socket)
DRAM DIMM Densities and Ranks	16GB 1Rx8, 32GB 1Rx4, 64GB 2Rx4, 128GB 4Rx4, 256GB 8Rx8
	48GB 1Rx4, 96GB 2Rx4
Maximum system capacity (DRAM DIMMs only)	6TB (24x256GB)

*Figure 4* is the supported 12-channel configuration, with one DPC.

Figure 4 12-Channel Memory Organization

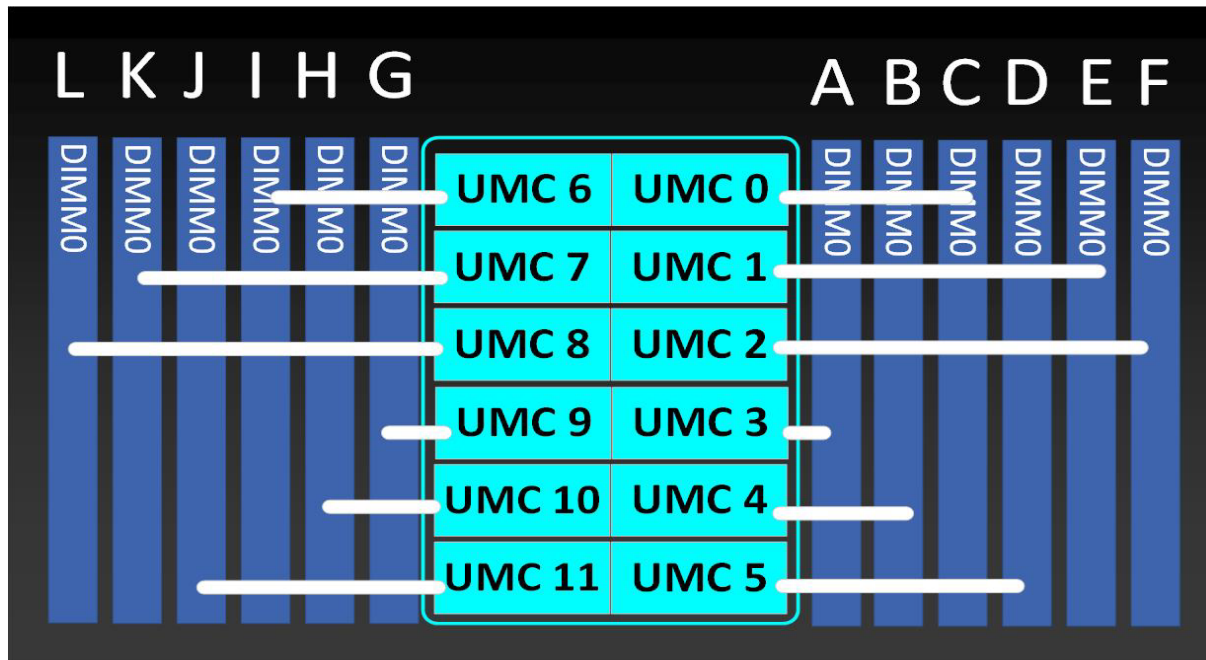

Select DIMMs

The supported memory DIMMs are listed in [Table 7](#).



**NOTE:** Cisco Memory DIMM PIDs used on M8 C245 server models are DDR5-5600 PIDs, although the memory will operate at the maximum speed of the AMD 4th Gen. CPU memory controller, up to 4800 MT/s. Check Table 5 for CPU SKUs definition and maximum memory speed

**Table 7 Available DDR5 DIMMs**

Product ID (PID)	PID Description <sup>1</sup>	Ranks/DIMM
UCS-MR256G8RE3 <sup>2</sup>	256GB DDR5-5600 RDIMM 8Rx4 (16Gb)	8
UCS-MR128G4RE3	128GB DDR5-5600 RDIMM 4Rx4 (16Gb)	4
UCS-MRX96G2RF3	96GB DDR5-5600 RDIMM 2Rx4 (24Gb)	2
UCS-MRX64G2RE3	64GB DDR5-5600 RDIMM 2Rx4 (16Gb)	2
UCS-MRX48G1RF3 <sup>2</sup>	48GB DDR5-5600 RDIMM 1Rx4 (24Gb)	1
UCS-MRX32G1RE3	32GB DDR5-5600 RDIMM 1Rx4 (16Gb)	1
UCS-MRX16G1RE3	16GB DDR5-5600 RDIMM 1Rx8 (16Gb)	1
<b>DIMM Blank<sup>3</sup></b>		
UCS-DIMM-BLK	UCS DIMM Blank	

Notes:

1. If higher or lower speed DIMMs are selected than for a given CPU speed, the DIMMs will be clocked at the lowest common denominator of CPU clock and DIMM clock. check the [Table 5](#) column “**Highest DDR5 DIMM Clock Support**”
2. Available in Q4CY24
3. Any empty DIMM slot must be populated with a DIMM blank to maintain proper cooling airflow.



## Memory configurations and mixing rules



**GOLDEN RULE:** Memory on every CPU socket shall be configured identically. Therefore, the memory configuration of CPU-1 will be identical to CPU-2 for a 2-Socket system. Unbalanced populations are unsupported.

- System speed is dependent on the CPU DIMM speed support. Refer to [Available CPUs, page 13](#) for DIMM speeds.
- For full details on supported memory configurations see the [M8 Memory Guide](#).
- DIMM Count Rules:

**Table 8 Allowed DIMM Count for 1-CPU and 2-CPU**

Allowed DIMM Count rules	Minimum Count	Maximum Count	Allowed Count	Not Allowed Count
<b>16GB, 32GB, 48GB, 64GB, 96GB, 128GB, 256GB (4th Gen. CPUs)<sup>1</sup></b>				
DIMM count for 1 CPU	1	12	1,2,4,6,8,10,12	3,5,7,9,11
DIMM count for 2-CPU	2	24	2,4,8,12,16,20,24	6,10,14,18, 22

**Notes:**

1. 1DPC support only.

- DIMM Population Rules:
  - When populating memory on a server powered by one or more 4th AMD EPYC processors:
    - All memory DIMMs must be RDIMM (16GB, 32GB, 48GB, 64GB, and 96GB) or RDIMM 3DS (128GB, and 256GB) module types.
    - All memory DIMMs must be Cisco DDR5-5600 memory PIDs, although the memory will operate at the maximum speed of the AMD 4th Gen. CPU memory controller, up to 4800 MT/s.
    - Balanced memory configurations maximize memory bandwidth by optimizing memory interleaving. To obtain a balanced memory configuration:
      - Populate each socket with 1, 2, 4, 6, 8, 10, or 12 memory channels.
      - Use the same memory configuration in all populated memory channels. No DIMM density mixing across channel is allowed.
      - Use the same DIMM configuration for each processor socket, on a 2-socket configuration.
      - No DIMM mixing within a channel is possible as C245 server supports only 1DPC.

Table 9 M8 DIMM population order for 16GB, 32GB, 48GB, 64GB, 96GB, 128GB, 256GB

#DIMMs per CPU	DIMM Population - 16GB, 32GB, 48GB, 64GB, 128GB, 256GB <sup>1</sup>
	Slot 1 (Blue)
1	A1
2	A1, G1
4	A1, C1, G1, I1
6	A1, B1, C1, G1, H1, I1
8	A1, B1, C1, E1, G1, H1, I1, K1
10	A1, B1, C1, D1, E1, G1, H1, I1, J1, K1
12	A1, B1, C1, D1, E1, F1, G1, H1, I1, J1, K1, L1

Notes:

1. 1DPC support only.

■ Memory Limitations:

- Memory on every CPU socket shall be configured identically.
- Refer to [Table 9](#) for DIMM population and DIMM mixing rules.
- Cisco Memory DIMM PIDs used on M8 C245 server models are DDR5-5600 PIDs, although the memory will operate at the maximum speed of the AMD 4th Gen. CPU memory controller, up to 4800 MT/s. Check Table 5 for CPU SKUs definition and maximum memory speed.

■ For best performance, observe the following:

Table 10 Maximum Memory Frequency - 4th Gen. CPU - 1 DIMM Per Channel only

4th Gen. CPU Memory Speed	DIMM	DIMM
	Rank	Max Speed
RDIMM	One Rank	4800 MT/s
	Two Rank	4800 MT/s
	Four Rank	4800 MT/s
	Eight Rank	4800 MT/s



**NOTE:** For full details on supported memory configurations see the [M8 Memory Guide](#).

## STEP 5 SELECT DRIVE CONTROLLERS

The following list summarizes how drives are controlled on the server:

- Up to 14 SAS/SATA/NVMe drives are controlled through a Cisco 24G Tri-mode RAID controller

### RAID Volumes and Groups

When creating each RAID volume, follow these guidelines:

- Use the same capacity for each drive in each RAID volume
- For the Cisco 24G Tri-mode RAID controller, use either all SAS HDDs, or all SAS SSDs, or all SATA SSDs or NVMe SSDs in each RAID volume.



**NOTE:** 240 virtual drives (VDs) per controller, with up to 16 per disk group with the 24G Tri Mode Controller.

#### Select RAID Controller Options

Select the following:

- Two Cisco 24G Tri-mode RAID controller (see [Table 11](#))



**NOTE:**

- If the Cisco 24G Tri-mode RAID controller, it is factory-installed in a dedicated slot.
- There is no RAID support for direct-attach NVMe drives.

Table 11 Hardware Controller Options

Product ID (PID)	PID Description
<b>Controllers for Internal Drives</b>	
UCSC-RAID-HP <sup>1,2</sup>	Cisco Tri-Mode 24G SAS RAID Controller w/4GB Cache <ul style="list-style-type: none"> <li>■ This RAID controller supports up to 14 SAS HDDs and SAS/SATA/NVMe SSDs operating at 3Gbps, 6Gbps, 12Gbps and 24Gbps. It includes a SuperCap and a 4GB flash-back write cache (FBWC)</li> <li>■ Supports RAID0, RAID00, 1, 5, 6, 10, 50, 60, and JBOD mode and supports mixed RAID and JBOD mode.</li> <li>■ The RAID controller plugs directly into a dedicated slot.</li> <li>■ For all self-encrypting drives (SED), standalone Management (CIMC/UCSM) is supported for configuring and managing local keys. For now, SED drives are managed with local key management only. Third-party key management will be supported (KMIP compliant).</li> <li>■ Requires 2-CPU configuration.</li> </ul>

Table 11 Hardware Controller Options (*continued*)

Product ID (PID)	PID Description
<b>Controllers for External Drives</b>	
UCSC-9500-8E-D	9500 Series PCIe Gen 4.0 Tri-Mode Storage HBA 12Gb/s SAS/SATA/PCIe (NVMe) <ul style="list-style-type: none"> <li>■ External Storage HBA plugs in to PCIe slot</li> <li>■ This controller is half-height half-length and can be installed in riser 1, 2, or 3.</li> </ul>
<b>Accessories/spare included with drive controller (For UCSC-C245-M8SX):</b> <ul style="list-style-type: none"> <li>■ UCS-SCAP-D, CBL-SCAP-C240-D and UCSC-HPBKT-24XM7 are included with the selection of UCSC-RAID-HP drive controller.</li> </ul> <b>NOTE:</b> If you are adding drive controller later as spare, you may need to order cables/supercap/super cables and controllers bracket with it.	

**Notes:**

1. When ordering UCSC-RAID-HP, please note that mixing SAS/SATA and NVMe drives in a single RAID volume is not supported. Virtual drives can only be created with drives of the same type.
2. U.3 NVMe drives selected with the Tri-mode RAID controller (UCSC-RAID-HP) will be set to RAID attached as the factory default. The U.3 drives in slots 1-4 can however operate in U.2 mode, directly attached to the CPU. This mode can be changed from the Cisco IMC if desired.

**RAID Configuration Option**

Select one of the RAID Configuration option from the following [Table 12](#).



**CAUTION:** All RAID options require drives of same sector size and media type. The smallest drive capacity will be used to calculate the RAID volume size.

Table 12 RAID Configuration Options

Product ID (PID)	PID Description
<b>NOTE:</b> Not available for Cisco 12G SAS HBA	
R2XX-SRAID0D	Enable single disk RAID 0 Setting.
R2XX-RAID0D	Factory preconfigured RAID striping option Enable RAID 0 Setting. Requires two or more drive.
R2XX-RAID00D	Factory preconfigured RAID striping option Enable RAID 00 Setting. Requires two or more drive.
R2XX-RAID1D	Factory preconfigured RAID mirroring option Enable RAID 1 Setting. Requires even number of drives (minimum of two).
R2XX-RAID5D	Factory preconfigured RAID option Enable RAID 5 Setting. Requires a minimum of three drives
R2XX-RAID6D	Factory preconfigured RAID option Enable RAID 6 Setting. Requires a minimum of four drives.

Table 12 RAID Configuration Options (*continued*)

Product ID (PID)	PID Description
R2XX-RAID10D	Factory preconfigured RAID option Enable RAID 10 Setting. Requires even number of drives (minimum of 2 drives per span)
R2XX-RAID50D	Factory preconfigured RAID option Enable RAID 50 Setting. Requires minimum of three drives per span
R2XX-RAID60D	Factory preconfigured RAID option Enable RAID 60 Setting. Requires minimum of four drives per span.

### Approved Configurations

---

Cisco UCS C245 M8 SFF server can be ordered as follows:

- UCSC-C245-M8SX (24-drive SAS/SATA/NVMe backplane and optionally 4 of those can be direct-attach NVMe)
- There is no RAID support for direct-attach NVMe drives.

## STEP 6 SELECT DRIVES

The standard disk drive features are:

- 2.5-inch small form factor
- Hot-pluggable
- Drives come mounted in sleds



**NOTE:** If more than two NVMe SSDs are selected, you must also select 2 CPUs.

### Select Drives



**CAUTION:** Cisco uses solid state drives (SSDs) from a number of vendors. All solid state drives (SSDs) are subject to physical write limits and have varying maximum usage limitation specifications set by the manufacturer. Cisco will not replace any solid state drives (SSDs) that have exceeded any maximum usage specifications set by Cisco or the manufacturer, as determined solely by Cisco.

The available drives are listed in [Table 13](#).

**Table 13 Available Hot-Pluggable Sled-Mounted Drives UCSC-C245-M8SX**

Product ID (PID)	PID Description	Drive Type	Capacity
<b>HDDs</b>			
<b>HDDs (10K RPM)</b>			
UCS-HD12TB10KJ4	1.2 TB 12G SAS 10K RPM SFF HDD	SAS	1.2 TB
UCS-HD18TB10KJ4	1.8 TB 12G SAS 10K RPM SFF HDD (4K)	SAS	1.8 TB
UCS-HD24TB10KJ4	2.4 TB 12G SAS 10K RPM SFF HDD (4K)	SAS	2.4 TB
UCS-HD600G10KJ4	600GB 12G SAS 10K RPM SFF HDD	SAS	600 GB
<b>Enterprise Performance SAS/SATA SSDs (High endurance, supports up to 10X or 3X DWPD (drive writes per day))</b>			
UCS-SD16TKA3X-EP	1.6TB 2.5in Enterprise Performance 12G SAS SSD(3X endurance)	SAS	1.6 TB
UCS-SD32TKA3X-EP	3.2TB 2.5in Enterprise Performance 12G SAS SSD(3X endurance)	SAS	3.2 TB
UCS-SD16TBKANK9	1.6TB 2.5" Enterprise performance 12GSAS SSD(3DWPD,SED-FIPS)	SAS	1.6 TB
UCS-SD480GBM3X-EP	480GB SATA SSD 3DWPD	SATA	480 GB
UCS-SD960GBM3X-EP	960GB SATA SSD 3DWPD	SATA	960 GB
UCS-SD19TBM3X-EP	1.9TB SATA SSD 3DWPD	SATA	1.9 TB
UCS-SD480G63X-EP	480GB 2.5 inch Enterprise performance 6GSATA SSD(3X endurance)	SATA	480 GB
UCS-SD960G63X-EP	960GB 2.5 inch Enterprise performance 6GSATA SSD(3X endurance)	SATA	960 GB
UCS-SD19T63X-EP	1.9TB 2.5 inch Enterprise performance 6GSATA SSD(3X endurance)	SATA	1.9 TB

Table 13 Available Hot-Pluggable Sled-Mounted Drives (continued)UCSC-C245-M8SX

Product ID (PID)	PID Description	Drive Type	Capacity
UCS-SD38T63X-EP	3.8TB 2.5 inch Enterprise performance 6GSATA SSD(3X endurance)	SATA	3.8 TB
UCS-SDB480OA1P	480GB 2.5in 15mm Solidigm S4620 Enter Perf 6G SATA 3X SSD	SATA	480 GB
UCS-SDB960OA1P	960GB 2.5in 15mm Solidigm S4620 Enter Perf 6G SATA 3X SSD	SATA	960 GB
UCS-SDB1T9OA1P	1.9TB 2.5in 15mm Solidigm S4620 Enter Perf 6G SATA 3X SSD	SATA	1.9 TB
UCS-SDB3T8OA1P	3.8TB 2.5in 15mm Solidigm S4620 Enter Perf 6G SATA 3X SSD	SATA	3.8 TB
<b>Enterprise Value SAS/SATA SSDs (High endurance, supports up to 10X or 3X DWPD (drive writes per day))</b>			
UCS-SD19TKA1X-EV	1.9TB 2.5 inch Enterprise Value 12G SAS SSD	SAS	1.9 TB
UCS-SD38TKA1X-EV	3.8TB 2.5 inch Enterprise Value 12G SAS SSD	SAS	3.8 TB
UCS-SD76TKA1X-EV	7.6TB 2.5 inch Enterprise Value 12G SAS SSD	SAS	7.6 TB
UCS-SD15TKA1X-EV	15.3TB 2.5 inch Enterprise Value 12G SAS SSD	SAS	15.3 TB
UCS-SD38TBKANK9	3.8TB 2.5" Enterprise value 12G SAS SSD (1DWPD, SED-FIPS)	SAS	3.8 TB
UCS-SD76TBKANK9	7.6TB Enterprise value SAS SSD (1 DWPD, SED-FIPS)	SAS	7.6 TB
UCS-SD960G6S1X-EV	960GB 2.5 inch Enterprise Value 6G SATA SSD	SATA	960 GB
UCS-SD19T6S1X-EV	1.9TB 2.5 inch Enterprise Value 6G SATA SSD	SATA	1.9 TB
UCS-SD38T6S1X-EV	3.8TB 2.5 inch Enterprise Value 6G SATA SSD	SATA	3.8 TB
UCS-SD76T6S1X-EV	7.6TB 2.5 inch Enterprise Value 6G SATA SSD	SATA	7.6 TB
UCS-SDB960SA1V	960GB 2.5in 6G SATA Enter Value 1X Samsung G1PM893A SSD	SATA	960 GB
UCS-SDB1T9SA1V	1.9TB 2.5in 6G SATA Enter Value 1X Samsung G1PM893A SSD	SATA	1.9 TB
UCS-SDB3T8SA1V	3.8TB 2.5in 6G SATA Enter Value 1X Samsung G1PM893A SSD	SATA	3.8 TB
UCS-SDB7T6SA1V	7.6TB 2.5in 6G SATA Enter Value 1X Samsung G1PM893A SSD	SATA	7.6 TB
UCS-SD240GBM1X-EV	240GB SATA SSD 1DWPD	SATA	240 GB
UCS-SD480GBM1X-EV	480GB SATA SSD 1DWPD	SATA	480 GB
UCS-SD960GBM1X-EV	960GB SATA SSD 1DWPD	SATA	960 GB
UCS-SD16TBM1X-EV	1.6GB SATA SSD 1DWPD	SATA	1.6 TB
UCS-SD19TBM1X-EV	1.9TB SATA SSD 1DWPD	SATA	1.9 TB
UCS-SD38TBM1X-EV	3.8TB SATA SSD 1DWPD	SATA	3.8 TB
UCS-SD76TBM1X-EV	7.6TB SATA SSD 1DWPD	SATA	7.6 TB
UCS-SDB480OA1V	480GB 2.5in 15mm Solidigm S4520 Enter Perf 6G SATA 1X SSD	SATA	480 GB
UCS-SDB960OA1V	960GB 2.5in 15mm Solidigm S4520 Enter Perf 6G SATA 1X SSD	SATA	960 GB
UCS-SDB3T8OA1V	3.8TB 2.5in 15mm Solidigm S4520 Enter Perf 6G SATA 1X SSD	SATA	3.8 TB
<b>Self-Encrypted Drives (SED)</b>			
UCS-SD38TBKANK9-D	3.8TB 2.5in Enterprise value 12G SAS SSD (1DWPD, SED-FIPS)	SED-FIPS	3.8 TB
UCS-SD76TBKANK9-D	7.6TB Enterprise value SAS SSD (1 DWPD, SED-FIPS)	SED	7.6 TB
UCS-SD19TEM2NK9-D	1.9TB Enterprise value SATA SSD (1X , SED)	SED	1.9 TB
UCS-SD38TEM2NK9-D	3.8TB Enterprise value SATA SSD (1X, SED)	SED-FIPS	3.8 TB
UCS-SD76TEM2NK9-D	7.6TB Enterprise value SATA SSD (1X, SED)	SED	7.6 TB

Table 13 Available Hot-Pluggable Sled-Mounted Drives (continued)UCSC-C245-M8SX

Product ID (PID)	PID Description	Drive Type	Capacity
UCS-SD960GM2NK9-D	960GB Enterprise value SATA SSD (1X , SED)	SED	960 GB
UCS-SD16TBKANK9-D	1.6TB 2.5 Enterprise performance 12GSAS SSD(3DWPD,SED-FIPS)	SED-FIPS	1.6 TB
<b>PCIe/NVMe SFF (2.5-inch) drives</b>			
UCS-NVME4-1600	1.6TB 2.5in U.2 P5620 NVMe High Perf High Endurance	NVMe	1.6 TB
UCS-NVME4-3200	3.2TB 2.5in U.2 P5620 NVMe High Perf High Endurance	NVMe	3.2 TB
UCS-NVME4-6400	6.4TB 2.5in U.2 P5620 NVMe High Perf High Endurance	NVMe	6.4 TB
UCS-NVME4-1920	1.9TB 2.5in U.2 P5520 NVMe High Perf Medium Endurance	NVMe	1.9 TB
UCS-NVME4-3840	3.8TB 2.5in U.2 P5520 NVMe High Perf Medium Endurance	NVMe	3.8 TB
UCS-NVME4-7680	7.6TB 2.5in U.2 P5520 NVMe High Perf Medium Endurance	NVMe	7.6 TB
UCS-NVME4-15360	15.3TB 2.5in U.2 P5520 NVMe High Perf Medium Endurance	NVMe	15.3 TB
UCS-NVMEQ-1536	15.3TB 2.5in U.2 P5316 NVMe High Perf Low Endurance	NVMe	15.3 TB
UCS-NVMEG4-M1536	15.3TB 2.5in U.3 Micron P7450 NVMe High Perf Medium Endurance	NVMe	15.3 TB
UCS-NVMEG4-M1600	1.6TB 2.5in U.3 Micron P7450 NVMe High Perf High Endurance	NVMe	1.6 TB
UCS-NVMEG4-M1920	1.9TB 2.5in U.3 Micron P7450 NVMe High Perf Medium Endurance	NVMe	1.9 TB
UCS-NVMEG4-M3200	3.2TB 2.5in U.3 Micron P7450 NVMe High Perf High Endurance	NVMe	3.2 TB
UCS-NVMEG4-M3840	3.8TB 2.5in U.3 Micron P7450 NVMe High Perf Medium Endurance	NVMe	3.8 TB
UCS-NVMEG4-M6400	6.4TB 2.5in U.3 Micron P7450 NVMe High Perf High Endurance	NVMe	6.4 TB
UCS-NVMEG4-M7680	7.6TB 2.5in U.3 Micron P7450 NVMe High Perf Medium Endurance	NVMe	7.6 TB
UCS-NVMEG4-M960	960GB 2.5in U.3 Micron P7450 NVMe High Perf Medium Endurance	NVMe	960 GB
UCS-NVB1T601P	1.6TB 2.5in U.2 15mm Solidigm P5620 Hg Perf Hg End 3X NVMe	NVMe	1.6 TB
UCS-NVB3T201P	3.2TB 2.5in U.2 15mm Solidigm P5620 Hg Perf Hg End 3X NVMe	NVMe	3.2 TB
UCS-NVB6T401P	6.4TB 2.5in U.2 15mm Solidigm P5620 Hg Perf Hg End 3X NVMe	NVMe	6.4 TB
UCS-NVB1T901V	1.9TB 2.5in U.2 15mm Solidigm P5520 Hg Perf Med End 1X NVMe	NVMe	1.9 TB
UCS-NVB3T801V	3.8TB 2.5in U.2 15mm Solidigm P5520 Hg Perf Med End 1X NVMe	NVMe	3.8 TB
UCS-NVB7T601V	7.6TB 2.5in U.2 15mm Solidigm P5520 Hg Perf Med End 1X NVMe	NVMe	7.6 TB
UCS-NVB15T01V	15.3TB 2.5in U.2 15mm Solidigm P5520 Hg Perf Med End 1X NVMe	NVMe	15.3 TB
<b>Accessories/spare included with drives (For UCSC-C245-M8SX):</b>			
<ul style="list-style-type: none"> <li>■ UCSC-BBLKD-M7 is included for the unselected front and rear storage device.</li> </ul>			
<p><b>NOTE:</b> If you decide to add front-facing NVMe drives later, you may need to order the drives as spare and also NVMe cables. Spare NVMe cables support depends on the drive controller installing/installed in the system.</p>			



## Caveats

---

### For UCSC-C245-M8SX:

- Front SFF NVMe drives 1-4 are connected directly to CPU2.
- The rear NVMe drives are controlled directly from the CPUs.
- If you order NVMe drives, you must also order two CPUs.
- SFF NVMe drives are bootable in UEFI mode only.
- You can mix HDDs and SSDs as long as you keep all HDDs in their own RAID volume and all SSDs in their own RAID volume.
- You can mix SAS HDDs and SAS/SATA SSDs when using a Cisco 24G Tri-Mode RAID controller.
- SED drives can be mixed with the non-SED drives in [Table 13 on page 22](#)
- Rear NVMe drives in riser 1B are connected directly to CPU1
- Rear NVMe drives in riser 3B/3D are connected directly to and require CPU 2

## STEP 7 SELECT OPTION CARD(s)

For up-to-date server compatibility, please check the Hardware and Software compatibility list (HCL) at <https://ucshcltool.cloudapps.cisco.com/public/>.

The standard card offerings are:

- Modular LAN on Motherboard (mLOM)
- Virtual Interface Cards (VICs)
- Network Interface Cards (NICs)
- Open Compute Project (OCP) 3.0 NIC
- Host Bus Adapters (HBAs)

### Select Option Cards

The available option cards are listed in [Table 14](#).

Table 14 Available Option Cards

Product ID (PID)	PID Description	Location	Card Size <sup>1</sup>
<b>Modular LAN on Motherboard (mLOM)/OCP</b>			
UCSC-M-V5Q50GV2-D	Cisco UCS VIC 15427 Quad Port CNA MLOM with Secure Boot	mLOM	HHHL, SS
UCSC-M-V5D200GV2D	Cisco UCS VIC 15238 Dual Port CNA MLOM with Secure Boot	mLOM	HHHL, SS
UCSC-O-ID10GC <sup>2</sup>	Intel X710T2LOCPV3G1L 2x10GbE RJ45 OCP3.0 NIC	mLOM/OCP 3.0 slot	-
<b>Virtual Interface Card (VICs)</b>			
UCSC-P-V5Q50G-D	Cisco UCS VIC 15425 Quad Port 10/25/50G CNA PCIE	Riser 1 or 2	HHHL, SS
UCSC-P-V5D200G-D	Cisco UCS VIC 15235 Dual Port 40/100/200G CNA PCIE	Riser 1 or 2	HHHL, SS
<b>Network Interface Cards (NICs)</b>			
<b>1 GbE NICs</b>			
UCSC-P-IQ1GC	Cisco-Intel I710-T4L 4x1GBASE-T NIC	Riser 1, 2, or 3	HHHL, SS
<b>10 GbE NICs</b>			
UCSC-PCIEID10GF-D	Intel X710-DA2 Dual Port 10Gb SFP+ NIC	Riser 1, 2, or 3	HHHL, SS
UCSC-P-ID10GC-D	Cisco-Intel X710T2LG 2x10 GbE RJ45 PCIe NIC	Riser 1, 2, or 3	HHHL, SS
<b>25 GbE NICs</b>			
UCSC-P-I8D25GF-D <sup>3</sup>	Cisco-Intel E810XXVDA2 2x25/10 GbE SFP28 PCIe NIC	Riser 1, 2, or 3	HHHL, SS
UCSC-P-N6D25GF-D <sup>3</sup>	Cisco-NVDA MCX631102AS-ADAT CX6Lx 2x25GbE SFP28 x8 PCIe NIC	Riser 1, 2, or 3	HHHL, SS
<b>100 GbE NICs</b>			
UCSC-P-I8D100GF-D <sup>3</sup>	Cisco-Intel E810CQDA2 2x100 GbE QSFP28 PCIe NIC	Riser 1, 2, or 3	HHHL, SS
UCSC-P-MDD100GF-D	Cisco-MLNX MCX623106AC-CDAT GbE 2x100G QSFP56 PCIe NIC	Riser 1, 2, or 3	HHHL, SS

Table 14 Available Option Cards (*continued*)

Product ID (PID)	PID Description	Location	Card Size <sup>1</sup>
<b>Host Bus Adapters (HBAs)</b>			
UCSC-P-Q6D32GF-D	Cisco-QLogic QLE2772 2x32GFC Gen 6 Enhanced PCIe HBA	Riser 1, 2, or 3	HHHL, SS
UCSC-PCIEQD16GF-D	Qlogic QLE2692 dual-port 16G FC HBA	Riser 1, 2, or 3	HHHL, SS

**Notes:**

1. HHHL = half-height, half-length; HHLH = half-height, half-length; SS = single-slot; DS = double-slot
2. The UCSC-O-ID10GC is an OCP 3.0 adapter and fits in mLOM /OCP 3.0 slot using a special mechanical connector add-on. See the following link for installation instructions:  
[https://www.cisco.com/content/en/us/td/docs/unified\\_computing/ucs/c/hw/c245m6/install/c245m6.html](https://www.cisco.com/content/en/us/td/docs/unified_computing/ucs/c/hw/c245m6/install/c245m6.html)
3. When present, the recommended Fan Speed Control policy setting is balanced

**Caveats**

- For 1-CPU systems:
    - All the PCIe slots on riser 1A and 1C are supported for the PCIe Cards.
    - Riser 2 and 3 are not supported in 1-CPU system.
    - Only a single plug-in PCIe VIC card may be installed on a 1-CPU system, and it must be installed in slots 1 or 2 of riser 1A or slot 1 of riser 1C.
    - You can order an mLOM VIC card to be installed in the mLOM/OCP 3.0 slot internal to the chassis and thus have two VIC cards in operation at the same time. If you order a double-width GPU, it must be installed in slot 2; then a PCIe VIC can be installed in slot 1. See the [Table 14 on page 26](#) for the selection of plug-in and mLOM/OCP 3.0 VIC cards.
  - For 2-CPU systems:
    - All the PCIe slots on riser 1, 2, and 3 are supported for the PCIe Cards.
    - You can order an mLOM VIC card to be installed in the mLOM slot internal to the chassis. You can also have up to two PCIe VICs.
      - If Riser 1A and 2A are selected, two PCIe VIC can be installed in slot 2 of Riser 1A and slot 5 of Riser 2A. If GPUs are installed in slot 2 of riser 1A or slot 5 of riser 2A, the NCSI capability automatically switches over to slot 1 of riser 1A or slot 4 of Riser 2A. Therefore, Cisco PCIe VICs can be installed in slot 1 of Riser 1A and slot 4 of Riser 2A if GPUs are installed in slots 2 of Riser 1A and slot 5 of Riser 2A.
      - If Riser 1C and 2C are selected, two PCIe VIC can be installed in slot 1 of Riser 1C and slot 4 of Riser 2C.
- See [Table 15 on page 30](#) for the selection of plug-in and mLOM VIC cards. See also [C245 M8 Server With Top Cover Off, page 47](#) and below table for the PCIe slot physical descriptions.
- The server supports up to two PCIe Cisco VICs plus an MLOM VIC. However, single wire management is supported on only one VIC at a time. If multiple VICs are installed on a server, only one slot has NCSI enabled at a time and for single wire management, priority goes to the MLOM slot, then slot 2 of riser 1A/slot 1 of riser 1C, then slot 5 of riser 2A/slot 4 of riser 2C for NCSI management traffic. When multiple cards are installed, connect the single wire management cables in the priority order mentioned above.

- For installation in the mLOM slot, you can order either an mLOM VIC, or the OCP NIC - but not both. If ordering the OCP NIC, the OCP Mechanical Kit (UCSC-OCP3-KIT) must also be installed in order to mount OCP NIC in the mLOM slot.



### NOTE:

- UCSM managed servers are discoverable only if a PCIe VIC is installed or a VIC is installed in the MLOM slot.
  - Select Cisco UCS Virtual Interface Cards incorporate VIC Secure Boot technology to ensure the integrity of the VIC hardware and firmware upon server boot. VIC Secure Boot is independent of server-level secure boot from Cisco, but both technologies contribute to the Cisco trust model ensuring customers' equipment is genuine and running validated firmware.
  - To help ensure that your operating system is compatible with the card you have selected, or to see additional cards that have been qualified to work with the UCS C240 M7 server, but are not sold on the Cisco price list, check the [Hardware Compatibility List](#) link.
-

## ORDER OPTIONAL PCIe OPTION CARD ACCESSORIES

- At the time of first launch, the 3rd Party Ethernet adapters were tested for interoperability with an initial selection of Optical Modules and Cables. Please check the Product Briefs for this initial list of interoperable optics and cables at <https://www.cisco.com/c/en/us/products/servers-unified-computing/third-party-adapters-listing.html>.
- For list of supported optics and cables for VIC 15428 and VIC 15238, refer to the VIC 15000 series data sheet at <https://www.cisco.com/c/en/us/products/collateral/interfaces-modules/unified-computing-system-adapters/ucs-vic-15000-series-ds.htm>
- Cisco Transceiver Module Group (TMG) conducts tests with Cisco optics and cables and publishes the results in the TMG Compatibility Matrix. The latest compatibility with optical modules and DACs can be found at <https://tmgmatrix.cisco.com/>
- Refer to the these links for additional connectivity options.

<b>Intel:</b>
<a href="#">Product Guide</a>
<a href="#">Speed White Paper</a>

## STEP 8 ORDER GPU CARDS (OPTIONAL)

### Select GPU Options

The available GPU PCIe options and their riser slot compatibilities are listed in [Table 15](#).



**CAUTION:** 256GB DIMMs cannot be combined with GPU cards, and the ambient temperature shall be limited to a maximum of 28°C.



**NOTE:**

- GPUs cannot be mixed
- All GPU cards must be procured from Cisco as there is a unique SBIOS ID required by CIMC and UCSM
- If a GPU with TDP equal or greater than 150W is ordered, all the 3 risers are required, and GPU airblocker will be installed in the middle slot of any empty riser in the system.
- If GPUs are installed in slot 2 of riser 1A/1C or slot 5 of riser 2A/2C, the NCSI capability automatically switches over to slot 1 of riser 1A/1C or slot 4 of Riser 2A/2C. Therefore, Cisco PCIe VICs can be installed in slots 1 and 4, if GPUs are installed in slots 2 and 5. If you order multiple GPUs, they must be installed as shown in [Table 15 on page 30](#).
- Please refer to [installation guide](#) for the installation of the GPUs.

Table 15 Available PCIe GPU Cards

GPU Product ID (PID)	PID Description	Card Size	Max GPU Per Node	Riser Slot Compatibility <sup>1</sup>			
				Riser 1A/1C	Riser 2A/2C	Riser 3C <sup>2</sup>	Riser 1B/3A/3B
UCSC-GPU-H100-NVL <sup>3</sup>	NVIDIA H100: 400W, 92GB, 2-slot FHFL GPU	double-wide	2	slot 2 (Riser 1C Only)	slot 5 (Riser 2C Only)	n/a	n/a
UCSC-GPU-L40	NVIDIA L40: 300W, 48GB, 2-slot FHFL GPU	double-wide	3	slot 2	slot 5	slot 7	n/a
UCSC-GPU-L4 <sup>4</sup>	NVIDIA L4:70W, 24GB, 1-slot HHHL GPU	Single-wide	8	All slots	All slots	slot 7	slot 7
UCSC-GPU-L40S	NVIDIA L40S: 350W, 48GB, 2-slot FHFL GPU	double-wide	2	slot 2	slot 5	n/a	n/a
UCSC-GPU-A16-D	NVIDIA A16 PCIe 250W 4X16GB	double-wide	3	slot 2	slot 5	slot 7	n/a

Table 15 Available PCIe GPU Cards

GPU Product ID (PID)	PID Description	Card Size	Max GPU Per Node	Riser Slot Compatibility <sup>1</sup>
<b>Accessories/spare included with GPU:</b>				
<ul style="list-style-type: none"> <li>■ When a GPU ready configuration is ordered, the server comes with low-profile heatsinks PID (UCSC-HSLP-C45M8), and special airblocker PID (UCSC-RISAB-245M8) for GPUs.</li> <li>■ Air duct (UCSC-GPUAD-C245M8) is <b>not</b> auto-included with the double wide GPUs, however it is required selection under configuration. For GPU UCSC-GPU-L4 <b>air duct is not</b> required.</li> <li>■ CBL-G5GPU-C240M7 power cable included with the selection of UCSC-GPU-L40S GPU.</li> <li>■ CBL-L40GPU-C240M7 Power cable included with the selection of UCSC-GPU-L40 GPU.</li> </ul> <p><b>NOTE:</b> If you are adding GPUs later to non-GPU ready configuration system, you may need to order the GPU airblocker on any empty risers in the system, GPU airduct, low profile heatsinks and cables needed along with the spare GPU.</p>				

**Notes:**

1. 1C and 2C are Gen 5 riser and 1A and 2A are Gen 4 riser.
2. The server supports one full-height, full-length, double-wide GPU (PCIe slot 7 only) in Riser 3C.
3. Available in 2H'CY2024
4. L4 is supported on all slots in PCIe risers. The maximum would be 8 when you have riser 1A+2A+3A and populate all 8 slots with L4. No cable is required.

## STEP 9 ORDER POWER SUPPLY

Power supplies share a common electrical and physical design that allows for hot-plug and tool-less installation into M6 C-series servers. Each power supply is certified for high-efficiency operation and offer multiple power output options. This allows users to “right-size” based on server configuration, which improves power efficiency, lower overall energy costs and avoid stranded capacity in the data center. Use the power calculator at the following link to determine the needed power based on the options chosen (CPUs, drives, memory, and so on):

<http://ucspowercalc.cisco.com>



**WARNING:**

- Starting 1<sup>st</sup> January 2024, only Titanium rated PSUs are allowed to be shipped to European Union (EU), European Economic Area (EEA), United Kingdom (UK), Switzerland and other countries that adopted Lot 9 Regulation.
- DC PSUs are not impacted by Lot 9 Regulation and are EU/UK Lot 9 compliant

Table 16 Power Supply

Product ID (PID)	PID Description
<b>PSU (Input High Line 210VAC)</b>	
UCSC-PSU1-1200W-D	1200W Titanium power supply for C-Series Servers
UCSC-PSUV21050D-D	Cisco UCS 1050W -48V DC Power Supply for Rack Server
UCSC-PSU1-1600W-D	UCS 1600W AC PSU Platinum (Not EU/UK Lot 9 Compliant)
UCSC-PSU1-2300W-D	Cisco UCS 2300W AC Power Supply for Rack Servers Titanium
<b>PSU (Input Low Line 110VAC)</b>	
UCSC-PSU1-1600W-D	UCS 1600W AC PSU Platinum (Not EU/UK Lot 9 Compliant)
UCSC-PSU1-2300W-D	Cisco UCS 2300W AC Power Supply for Rack Servers Titanium



**NOTE:** In a server with two power supplies, both power supplies must be identical.



## STEP 10 SELECT INPUT POWER CORD(S)

Using [Table 17](#) and [Table 18](#), select the appropriate AC power cords. You can select a minimum of no power cords and a maximum of two. If you select the option R2XX-DMYPWRCORD, no power cord is shipped with the server.



**NOTE:** [Table 17](#) lists the power cords for servers that use power supplies less than 2300 W. [Table 18](#) lists the power cords for servers that use 2300 W power supplies. Note that the power cords for 2300 W power supplies use a C19 connector so they only fit the 2300 W power supply connector.

**Table 17 Available Power Cords (for server PSUs less than 2300 W)**

Product ID (PID)	PID Description	Images
NO-POWER-CORD	ECO friendly green option, no power cable will be shipped	
R2XX-DMYPWRCORD	No power cord (dummy PID to allow for a no power cord option)	Not applicable
CAB-48DC-40A-8AWG	C-Series -48VDC PSU Power Cord, 3.5M, 3 Wire, 8AWG, 40A	<p>Figure 1-3 CAB-48DC-40A-8AWG, DC Power Cord (3.5 m)</p>
CAB-N5K6A-NA	Power Cord, 200/240V 6A, North America	
CAB-AC-L620-C13	AC Power Cord, NEMA L6-20 - C13, 2M/6.5ft	
CAB-C13-CBN	CABASY,WIRE,JUMPER CORD, 27" L, C13/C14, 10A/250V	
CAB-C13-C14-2M	CABASY,WIRE,JUMPER CORD, PWR, 2 Meter, C13/C14,10A/250V	

Table 17 Available Power Cords (for server PSUs less than 2300 W)

Product ID (PID)	PID Description	Images
CAB-C13-C14-AC	CORD,PWR,JMP,IEC60320/C14,IEC60320/C13, 3.0M	
CAB-250V-10A-AR	Power Cord, 250V, 10A, Argentina	
CAB-9K10A-AU	Power Cord, 250VAC 10A 3112 Plug, Australia	
CAB-250V-10A-CN	AC Power Cord - 250V, 10A - PRC	
CAB-9K10A-EU	Power Cord, 250VAC 10A CEE 7/7 Plug, EU	
CAB-250V-10A-ID	Power Cord, 250V, 10A, India	
CAB-C13-C14-3M-IN	Power Cord Jumper, C13-C14 Connectors, 3 Meter Length, India	Image not available
CAB-C13-C14-IN	Power Cord Jumper,C13-C14 Connectors,1.4 Meter Length, India	Image not available
CAB-250V-10A-IS	Power Cord, SFS, 250V, 10A, Israel	

Table 17 Available Power Cords (for server PSUs less than 2300 W)

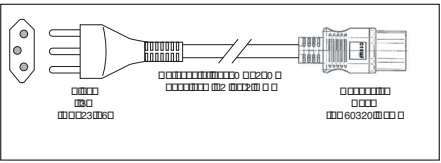
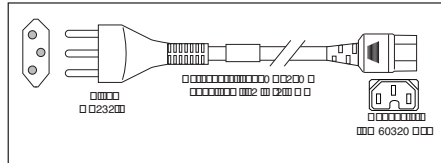
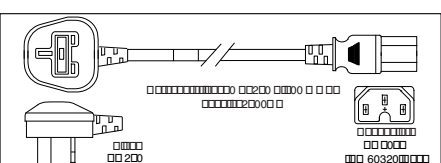
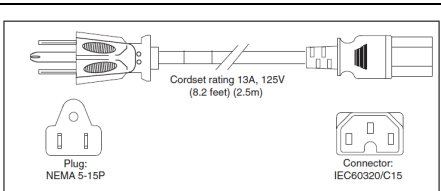
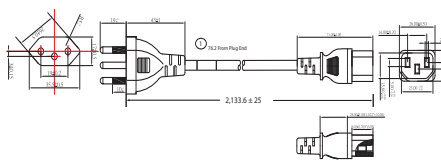
Product ID (PID)	PID Description	Images
CAB-9K10A-IT	Power Cord, 250VAC 10A CEI 23-16/VII Plug, Italy	
CAB-9K10A-SW	Power Cord, 250VAC 10A MP232 Plug, Switzerland	
CAB-9K10A-UK	Power Cord, 250VAC 10A BS1363 Plug (13 A fuse), UK	
CAB-9K12A-NA <sup>1</sup>	Power Cord, 125VAC 13A NEMA 5-15 Plug, North America	
CAB-250V-10A-BR	Power Cord - 250V, 10A - Brazil	
CAB-C13-C14-2M-JP	Power Cord C13-C14, 2M/6.5ft Japan PSE mark	Image not available
CAB-9K10A-KOR <sup>1</sup>	Power Cord, 125VAC 13A KSC8305 Plug, Korea	Image not available
CAB-ACTW	AC Power Cord (Taiwan), C13, EL 302, 2.3M	Image not available
CAB-JPN-3PIN	Japan, 90-125VAC 12A NEMA 5-15 Plug, 2.4m	Image not available

Notes:

1. This power cord is rated to 125V and only supported for PSU rated at 1050W or less

Table 18 Available Power Cords (for servers with 2300 W PSUs)

Product ID (PID)	PID Description	Images
CAB-C19-CBN	Cabinet Jumper Power Cord, 250 VAC 16A, C20-C19 Connectors	Not applicable
CAB-S132-C19-ISRL	S132 to IEC-C19 14ft Israeli	Image not available
CAB-IR2073-C19-AR	IRSM 2073 to IEC-C19 14ft Argen	Image not available
CAB-BS1363-C19-UK	BS-1363 to IEC-C19 14ft UK	Image not available
CAB-SABS-C19-IND	SABS 164-1 to IEC-C19 India	Image not available
CAB-C2316-C19-IT	CEI 23-16 to IEC-C19 14ft Italy	Image not available
CAB-L520P-C19-US	NEMA L5-20 to IEC-C19 6ft US	Image not available
CAB-US515P-C19-US	NEMA 5-15 to IEC-C19 13ft US	Image not available
CAB-US520-C19-US	NEMA 5-20 to IEC-C19 14ft US	Image not available
CAB-US620P-C19-US	NEMA 6-20 to IEC-C19 13ft US	Image not available

## STEP 11 ORDER TOOL-LESS RAIL KIT AND OPTIONAL REVERSIBLE CABLE MANAGEMENT ARM

### Select a Tool-less Rail Kit

Select a tool-less rail kit (or no rail kit) from [Table 19](#).

Table 19 Tool-less Rail Kit Options

Product ID (PID)	PID Description
UCSC-RAIL-D	Ball Bearing Rail Kit for C225 & C245 M8 rack servers
UCSC-RAIL-NONE-D	No rail kit option



**NOTE:** Cisco recommends a minimum quantity of 1 Rail Kit.

### Select an Optional Reversible Cable Management Arm

The reversible cable management arm mounts on either the right or left slide rails at the rear of the server and is used for cable management. Use [Table 20](#) to order a cable management arm.

Table 20 Cable Management Arm

Product ID (PID)	PID Description
UCSC-CMA-C240-D	Reversible CMA for C240 M8 ball bearing rail kit

For more information about the tool-less rail kit and cable management arm, see the *Cisco UCS C245 M8 Installation and Service Guide* at this URL:

[https://www.cisco.com/content/en/us/td/docs/unified\\_computing/ucs/c/hw/c245m6/install/c245m6.html](https://www.cisco.com/content/en/us/td/docs/unified_computing/ucs/c/hw/c245m6/install/c245m6.html)



**NOTE:** If you plan to rackmount your UCS C245 M8 server, you must order a tool-less rail kit. The same rail kits and CMAs are used for M5 and M6 servers.

## STEP 12 SELECT MANAGEMENT CONFIGURATION (OPTIONAL)

By default, the C245 M8 server NIC mode is configured to be Shared LOM Extended. This NIC mode allows any LOM port or adapter card port to be used to access the Cisco Integrated.



### NOTE:

- There are no LOM ports on the C245 M8 servers. Servers ordered without a VIC or OCP card will ship in Dedicated network mode, unless otherwise specified by a configurable SW PID (**UCSC-CCARD-01**)
- For full details on all the NIC mode settings, see

[https://www.cisco.com/c/en/us/td/docs/unified\\_computing/ucs/c/hw/c220m6/install/c220m7/m\\_maintaining\\_the\\_server.html?bookSearch=true](https://www.cisco.com/c/en/us/td/docs/unified_computing/ucs/c/hw/c220m6/install/c220m7/m_maintaining_the_server.html?bookSearch=true)

Table 21 Management Configuration Ordering Information

Product ID (PID)	PID Description
UCSC-DLOM-01-D	Dedicated Mode BIOS setting for C-Series Servers <ul style="list-style-type: none"> <li>■ To change the default NIC mode to Dedicated NIC mode, select this card</li> <li>■ In Dedicated NIC mode, the CIMC can be accessed only through the dedicated management port.</li> <li>■ See <i>Chassis Rear View (UCSC-C245-M8SX)</i>, page 5 for the location of the management port</li> </ul>
UCSC-CCARD-01-D	Cisco Card Mode BIOS setting for C-Series Servers <ul style="list-style-type: none"> <li>■ To change the default NIC mode to Cisco Card Mode, select this card</li> <li>■ If Cisco card selected, a VIC or MLOM must also be included in the configuration. if OCP card is included in the configuration, a VIC card must be selected.</li> <li>■ In this mode, you can assign an IP address to the CIMC using DHCP and from there you can fully automate your deployment.</li> </ul>

In addition, the optional software PIDS listed in [Table 26 on page 42](#) can be ordered for setting the server to operate in various modes.

## STEP 13 ORDER SECURITY DEVICES (OPTIONAL)

A Trusted Platform Module (TPM) is a computer chip (microcontroller) that can securely store artifacts used to authenticate the platform (server). These artifacts can include passwords, certificates, or encryption keys. A TPM can also be used to store platform measurements that help ensure that the platform remains trustworthy. Authentication (ensuring that the platform can prove that it is what it claims to be) and attestation (a process helping to prove that a platform is trustworthy and has not been breached) are necessary steps to ensure safer computing in all environments.

A chassis intrusion switch gives a notification of any unauthorized mechanical access into the server.

The security device ordering information is listed in [Table 22](#)



**NOTE:**

- The TPM module used in this system conforms to TPM v2.0, as defined by the Trusted Computing Group (TCG). It is also SPI-based.
- TPM installation is supported after-factory. However, a TPM installs with a one-way screw and cannot be replaced, upgraded, or moved to another server. If a server with a TPM is returned, the replacement server must be ordered with a new TPM.

**Table 22 Security Devices**

Product ID (PID)	PID Description
UCS-TPM2-002D-D	Trusted Platform Module 2.0 FIPS 140-2 and Windows 22 compliant for AMD M8 servers
UCSC-INT-SW02-D	C220, C240 M7 and C245 M8 Chassis Intrusion Switch
UCSX-TPM-OPT-OUT-D	OPT OUT, TPM 2.0, TCG, FIPS140-2, CC EAL4+ Certified <sup>1</sup>

**Notes:**

1. Please note that Microsoft certification requires a TPM 2.0 for bare-metal or guest VM deployments. Opt-out of the TPM 2.0 voids the Microsoft certification

## STEP 14 SELECT LOCKING SECURITY BEZEL (OPTIONAL)

An optional locking bezel can be mounted to the front of the chassis to prevent unauthorized access to the drives.

Select the locking bezel from [Table 23](#).

Table 23 Locking Bezel Option

Product ID (PID)	Description
UCSC-BZL-C240-D	Security Bezel



## STEP 15 ORDER M.2 SATA SSDs (OPTIONAL)

- Order one or two matching M.2 SATA SSDs from [Table 24](#) along with a boot-optimized RAID controller (see [Table 25](#)). See [Figure 5 on page 47](#) for the location of the module connector on the motherboard. The motherboard connector accepts the extender board and the extender board accepts the boot-optimized RAID controller. Each boot-optimized RAID controller can accommodate up to two SATA M.2 SSDs.



**NOTE:**

- It is recommended that M.2 SATA SSDs be used as boot-only devices.
- Order one or two identical M.2 SATA SSDs for the boot optimized RAID controller
- You cannot mix M.2 SATA SSD capacities.

**Table 24 M.2 SATA SSDs**

Product ID (PID)	PID Description
UCS-M2-I240GB-D	240GB SATA M.2 SSD
UCS-M2-I480GB-D	480GB SATA M.2 SSD
UCS-M2-240G-D	240GB M.2 SATA Micron G2 SSD
UCS-M2-480G-D	480GB M.2 SATA SSD
UCS-M2-960G-D	960GB M.2 SATA Micron G2 SSD

- Order Cisco boot optimized M.2 RAID controller from [Table 25](#). The boot optimized RAID controller plugs into a extender board on the motherboard and holds up to two M.2 SATA drives.



**NOTE:**

- The Cisco boot optimized M.2 RAID controller supports VMWare, Windows and Linux Operating Systems
- The Cisco boot optimized M.2 RAID controller supports RAID 1 and JBOD mode
- The Cisco boot optimized M.2 RAID controller is available only with 240GB, 480GB, and 960GB M.2 SSDs.
- CIMC is supported for configuring of volumes and monitoring of the controller and installed SATA M.2 drives
- The SATA M.2 drives can boot in UEFI mode only. Legacy boot mode is not supported
- Hot-plug replacement is not supported. The server must be powered off.

**Table 25 Boot-Optimized RAID Controller**

Product ID (PID)	PID Description
UCS-M2-HWRAID-D	Cisco Boot optimized M.2 RAID controller (holds up to two M.2 SATA SSDs)

Accessories/spare included with Boot-Optimized RAID Controller:

- UCSC-M2EXT-240-D is included with the selection of this Boot-Optimized RAID Controller.

**NOTE:** if you are adding later UCS-M2-HWRAID-D= as a spare you may need order UCSC-M2EXT-240-D= along with it

## STEP 16 SELECT OPERATING SYSTEM AND VALUE-ADDED SOFTWARE

Select

- Cisco Software ([Table 26](#))
- Operating System ([Table 27](#))



### NOTE:

- See this link for operating system guidance: <https://ucshcltool.cloudapps.cisco.com/public/>
- VMware is on Compliance Hold. Contact the [Compute-Vmware-Hold@cisco.com](mailto:Compute-Vmware-Hold@cisco.com) mailer to see if you are allowed to receive VMware Licenses

Table 26 OEM Software

Product ID (PID)	PID Description
<b>VMware vCenter</b>	
VMW-VCS-STD-D1A	VMware vCenter 7 Server Standard, 1 yr support required
VMW-VCS-STD-D3A	VMware vCenter 7 Server Standard, 3 yr support required
VMW-VCS-STD-D5A	VMware vCenter 7 Server Standard, 5 yr support required
VMW-VCS-FND-D1A	VMware vCenter Server 7 Foundation (4 Host), 1 yr supp reqd
VMW-VCS-FND-D3A	VMware vCenter Server 7 Foundation (4 Host), 3 yr supp reqd
VMW-VCS-FND-D5A	VMware vCenter Server 7 Foundation (4 Host), 5 yr supp reqd

Table 27 Operating System

Product ID (PID)	PID Description
<b>Microsoft Windows Server</b>	
MSWS-22-ST16CD	Windows Server 2022 Standard (16 Cores/2 VMs)
MSWS-22-ST16CD-NS	Windows Server 2022 Standard (16 Cores/2 VMs) - No Cisco SVC
MSWS-22-DC16CD	Windows Server 2022 Data Center (16 Cores/Unlimited VMs)
MSWS-22-DC16CD-NS	Windows Server 2022 DC (16 Cores/Unlim VMs) - No Cisco SVC
<b>Red Hat</b>	
RHEL-2S2V-D1A	Red Hat Enterprise Linux (1-2 CPU,1-2 VN); 1-Yr Support Req
RHEL-2S2V-D3A	Red Hat Enterprise Linux (1-2 CPU,1-2 VN); 3-Yr Support Req

Table 27 Operating System (continued)

Product ID (PID)	PID Description
RHEL-2S2V-D5A	Red Hat Enterprise Linux (1-2 CPU,1-2 VN); 5-Yr Support Req
RHEL-VDC-2SUV-D1A	RHEL for Virt Datacenters (1-2 CPU, Unlim VN) 1 Yr Supp Req
RHEL-VDC-2SUV-D3A	RHEL for Virt Datacenters (1-2 CPU, Unlim VN) 3 Yr Supp Req
RHEL-VDC-2SUV-D5A	RHEL for Virt Datacenters (1-2 CPU, Unlim VN) 5 Yr Supp Req
<b>Red Hat Ent Linux/ High Avail/ Res Strg/ Scal</b>	
RHEL-2S2V-D1S	Red Hat Enterprise Linux (1-2 CPU,1-2 VN); Prem 1Yr SnS Reqd
RHEL-2S2V-D3S	Red Hat Enterprise Linux (1-2 CPU,1-2 VN); Prem 3Yr SnS Reqd
RHEL-2S-HA-D1S	RHEL High Availability (1-2 CPU); Premium 1-yr SnS Reqd
RHEL-2S-HA-D3S	RHEL High Availability (1-2 CPU); Premium 3-yr SnS Reqd
RHEL-2S-RS-D1S	RHEL Resilent Storage (1-2 CPU); Premium 1-yr SnS Reqd
RHEL-2S-RS-D3S	RHEL Resilent Storage (1-2 CPU); Premium 3-yr SnS Reqd
RHEL-VDC-2SUV-D1S	RHEL for Virt Datacenters (1-2 CPU, Unlim VN) 1 Yr SnS Reqd
RHEL-VDC-2SUV-D3S	RHEL for Virt Datacenters (1-2 CPU, Unlim VN) 3 Yr SnS Reqd
<b>Red Hat SAP</b>	
RHEL-SAP-2S2V-D1S	RHEL for SAP Apps (1-2 CPU, 1-2 VN); Prem 1-Yr SnS Reqd
RHEL-SAP-2S2V-D3S	RHEL for SAP Apps (1-2 CPU, 1-2 VN); Prem 3-Yr SnS Reqd
RHEL-SAPSP-D3S	RHEL SAP Solutions Premium - 3 Years
RHEL-SAPSS-D3S	RHEL SAP Solutions Standard - 3 Years
<b>VMware</b>	
VMW-VSP-STD-D1A	VMware vSphere 7 Std (1 CPU, 32 Core) 1-yr, Support Required
VMW-VSP-STD-D3A	VMware vSphere 7 Std (1 CPU, 32 Core) 3-yr, Support Required
VMW-VSP-STD-D5A	VMware vSphere 7 Std (1 CPU, 32 Core) 5-yr, Support Required
VMW-VSP-EPL-D1A	VMware vSphere 7 Ent Plus (1 CPU, 32 Core) 1Yr, Support Reqd
VMW-VSP-EPL-D3A	VMware vSphere 7 Ent Plus (1 CPU, 32 Core) 3Yr, Support Reqd
VMW-VSP-EPL-D5A	VMware vSphere 7 Ent Plus (1 CPU, 32 Core) 5Yr, Support Reqd
<b>SUSE</b>	
SLES-2S2V-D1A	SUSE Linux Enterprise Svr (1-2 CPU,1-2 VM); 1-Yr Support Req
SLES-2S2V-D3A	SUSE Linux Enterprise Svr (1-2 CPU,1-2 VM); 3-Yr Support Req
SLES-2S2V-D5A	SUSE Linux Enterprise Svr (1-2 CPU,1-2 VM); 5-Yr Support Req

Table 27 Operating System (*continued*)

Product ID (PID)	PID Description
SLES-2SUVM-D1A	SUSE Linux Enterprise Svr (1-2 CPU,Unl VM) LP; 1Y Supp Req
SLES-2SUVM-D3A	SUSE Linux Enterprise Svr (1-2 CPU,Unl VM) LP; 3Y Supp Req
SLES-2SUVM-D5A	SUSE Linux Enterprise Svr (1-2 CPU,Unl VM) LP; 5Y Supp Req
SLES-2S-LP-D1A	SUSE Linux Live Patching Add-on (1-2 CPU); 1yr Support Req
SLES-2S-LP-D3A	SUSE Linux Live Patching Add-on (1-2 CPU); 3yr Support Req
SLES-2S2V-D1S	SUSE Linux Enterprise Svr (1-2 CPU,1-2 VM); Prio 1-Yr SnS
SLES-2S2V-D3S	SUSE Linux Enterprise Svr (1-2 CPU,1-2 VM); Prio 3-Yr SnS
SLES-2S2V-D5S	SUSE Linux Enterprise Svr (1-2 CPU,1-2 VM); Prio 5-Yr SnS
SLES-2SUVM-D1S	SUSE Linux Enterprise Svr (1-2 CPU,Unl VM) LP; Prio 1Y SnS
SLES-2SUVM-D3S	SUSE Linux Enterprise Svr (1-2 CPU,Unl VM) LP; Prio 3Y SnS
SLES-2SUVM-D5S	SUSE Linux Enterprise Svr (1-2 CPU,Unl VM) LP; Prio 5Y SnS
SLES-2S-HA-D1S	SUSE Linux High Availability Ext (1-2 CPU); 1yr SnS
SLES-2S-HA-D3S	SUSE Linux High Availability Ext (1-2 CPU); 3yr SnS
SLES-2S-HA-D5S	SUSE Linux High Availability Ext (1-2 CPU); 5yr SnS
SLES-2S-GC-D1S	SUSE Linux GEO Clustering for HA (1-2 CPU); 1yr Sns
SLES-2S-GC-D3S	SUSE Linux GEO Clustering for HA (1-2 CPU); 3yr SnS
SLES-2S-GC-D5S	SUSE Linux GEO Clustering for HA (1-2 CPU); 5yr SnS
SLES-2S-LP-D1S	SUSE Linux Live Patching Add-on (1-2 CPU); 1yr SnS Required
SLES-2S-LP-D3S	SUSE Linux Live Patching Add-on (1-2 CPU); 3yr SnS Required
<b>SLES and SAP</b>	
SLES-SAP-2S2V-D1S	SLES for SAP Apps (1-2 CPU, 1-2 VM); Priority 1-Yr SnS
SLES-SAP-2S2V-D3S	SLES for SAP Apps (1-2 CPU, 1-2 VM); Priority 3-Yr SnS
SLES-SAP-2S2V-D5S	SLES for SAP Apps (1-2 CPU, 1-2 VM); Priority 5-Yr SnS
SLES-SAP2SUVM-D1S	SLES for SAP Apps (1-2 CPU, Unl VM) LP; Priority 1Y SnS
SLES-SAP2SUVM-D3S	SLES for SAP Apps (1-2 CPU, Unl VM) LP; Priority 3Y SnS
SLES-SAP2SUVM-D5S	SLES for SAP Apps (1-2 CPU, Unl VM) LP; Priority 5Y SnS
SLES-SAP-2S2V-D1A	SLES for SAP Apps w/ HA (1-2 CPU, 1-2 VM); 1-Yr Support Reqd
SLES-SAP-2S2V-D3A	SLES for SAP Apps w/ HA (1-2 CPU, 1-2 VM); 3-Yr Support Reqd
SLES-SAP-2S2V-D5A	SLES for SAP Apps w/ HA (1-2 CPU, 1-2 VM); 5-Yr Support Reqd

Table 27 Operating System (*continued*)

Product ID (PID)	PID Description
SLES-SAP2SUVM-D1A	SLES for SAP Apps w/ HA (1-2 CPU, Unl VM) LP; 1Y Supp Reqd
SLES-SAP2SUVM-D3A	SLES for SAP Apps w/ HA (1-2 CPU, Unl VM) LP; 3Y Supp Reqd
SLES-SAP2SUVM-D5A	SLES for SAP Apps w/ HA (1-2 CPU, Unl VM) LP; 5Y Supp Reqd

## STEP 17 SELECT OPERATING SYSTEM MEDIA KIT

Select the optional operating system media listed in [Table 28](#).

Table 28 OS Media

Product ID (PID)	PID Description
MSWS-19-ST16C-RM	Windows Server 2019 Stan (16 Cores/2 VMs) Rec Media DVD Only
MSWS-19-DC16C-RM	Windows Server 2019 DC (16Cores/Unlim VM) Rec Media DVD Only
MSWS-22-ST16C-RM	Windows Server 2022 Stan (16 Cores/2 VMs) Rec Media DVD Only
MSWS-22-DC16C-RM	Windows Server 2022 DC (16Cores/Unlim VM) Rec Media DVD Only

# SUPPLEMENTAL MATERIAL

## Chassis

An internal view of the C245 M8 chassis with the top cover removed is shown in *Figure 5*.

**Figure 5** C245 M8 Server With Top Cover Off

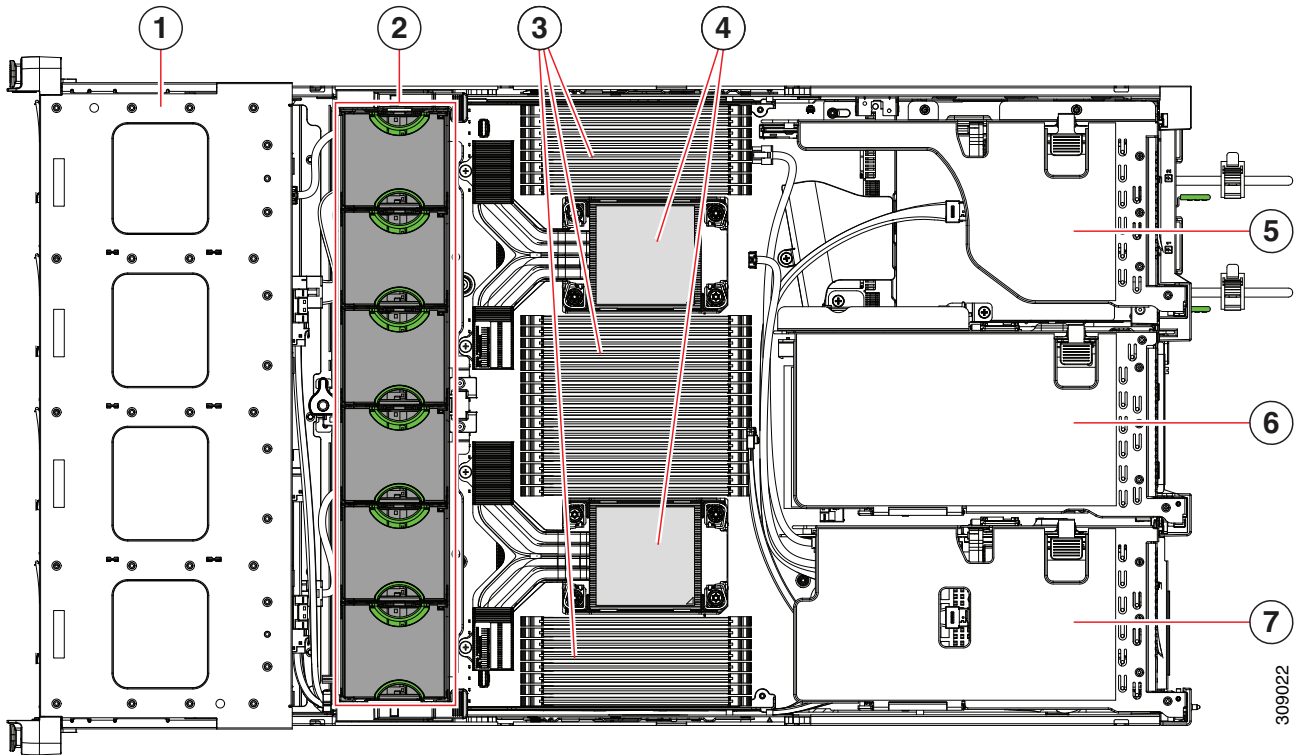

1	Front-loading drive bays.	2	Cooling fan modules (six, hot-swappable)
3	DIMM sockets on motherboard (12 per CPU) An air baffle rests on top of the DIMMs and CPUs when the server is operating. The air baffle is not displayed in this illustration.	4	CPU sockets CPU 2 is at the top and CPU 1 is at the bottom.

<p><b>5</b></p>	<p>PCIe riser 3 (PCIe slots 7 and 8 numbered from bottom to top), with the following options:</p> <ul style="list-style-type: none"> <li>■ 3A (I/O Option):</li> </ul> <p><b>Slot 7</b> (x24 mechanical, x8 electrical) supports full height, full length GPU card</p> <p><b>Slot 8</b> (x24 mechanical, x8 electrical) supports full height, full length GPU card</p> <ul style="list-style-type: none"> <li>■ 3B (Storage Option):</li> </ul> <p><b>Drive bay 103</b> (x4 electrical) supports 2.5-inch SFF universal HDD</p> <p><b>Drive bay 104</b> (x4 electrical) supports 2.5-inch SFF universal HDD</p> <ul style="list-style-type: none"> <li>■ 3C (GPU Option):</li> </ul> <p><b>Slot 7</b> (x24 mechanical, x16 electrical) support a full height, full length, double-wide GPU card</p> <p><b>Slot 8</b> empty (No NCSI support)</p> <ul style="list-style-type: none"> <li>■ 3D (Storage Option):</li> </ul> <p><b>Drive bay 103</b> (x4 electrical) supports 2.5-inch SFF universal HDD</p> <p><b>Drive bay 104</b> (x4 electrical) supports 2.5-inch SFF universal HDD</p>	<p><b>6</b></p>	<p>PCIe riser 2 (PCIe slots 4, 5, 6 numbered from bottom to top), with the following options:</p> <ul style="list-style-type: none"> <li>■ 2A (I/O Option):</li> </ul> <p><b>Slot 4</b> (x24 mechanical, x8 electrical) supports full height, ¾ length card;</p> <p><b>Slot 5</b> (x24 mechanical, x16 electrical) supports full height, full length GPU card;</p> <p><b>Slot 6</b> (x16 mechanical, x8 electrical) supports full height, full length card</p> <ul style="list-style-type: none"> <li>■ 2C (I/O Option):</li> </ul> <p><b>Slot 4</b> (x24 mechanical, x16 electrical) supports full height, ¾ length card;</p> <p><b>Slot 5</b> (x16 mechanical, x16 electrical) supports full height, full length GPU card</p>
<p><b>7</b></p>	<p>PCIe riser 1 (PCIe slot 1, 2, 3 numbered bottom to top), with the following options:</p> <ul style="list-style-type: none"> <li>■ 1A (I/O Option):</li> </ul> <p><b>Slot 1</b> (x24 mechanical, x8 electrical) supports full height, ¾ length card;</p> <p><b>Slot 2</b> (x24 mechanical, x16 electrical) supports full height, full length GPU card;</p> <p><b>Slot 3</b> (x24 mechanical, x16 electrical) supports full height, full length card.</p> <ul style="list-style-type: none"> <li>■ 1B (Storage Option):</li> </ul> <p><b>Slot 1</b> is reserved;</p> <p><b>Drive bay 101</b> (x4 electrical), supports 2.5-inch SFF universal HDD;</p> <p><b>Drive bay 102</b> (x4 electrical), supports 2.5-inch SFF universal HDD</p> <ul style="list-style-type: none"> <li>■ 1C (I/O Option):</li> </ul> <p><b>Slot 1</b> (x24 mechanical, x16 electrical) supports full height, ¾ length card;</p> <p><b>Slot 2</b> (x16 mechanical, x16 electrical) supports full height, full length GPU card.</p>	<p>-</p>	



## Riser Card Configurations and Options

The riser card locations are shown in *Figure 6*.

Figure 6 Riser Card Locations

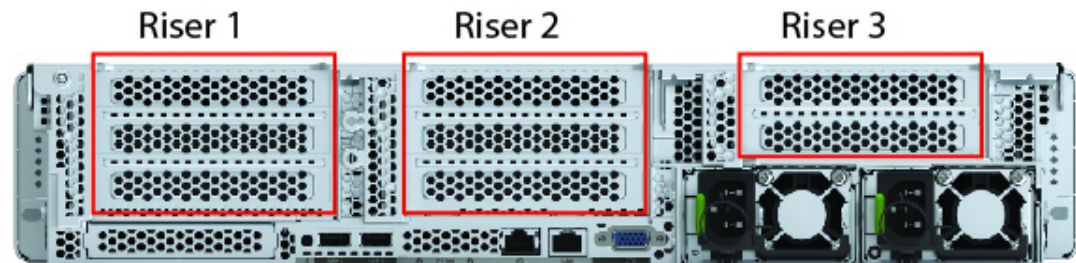

### Riser 1A

Riser 1A mechanical information is shown in *Figure 7*.

Figure 7 Riser Card 1A

#### PCIe Riser 1A (outside)

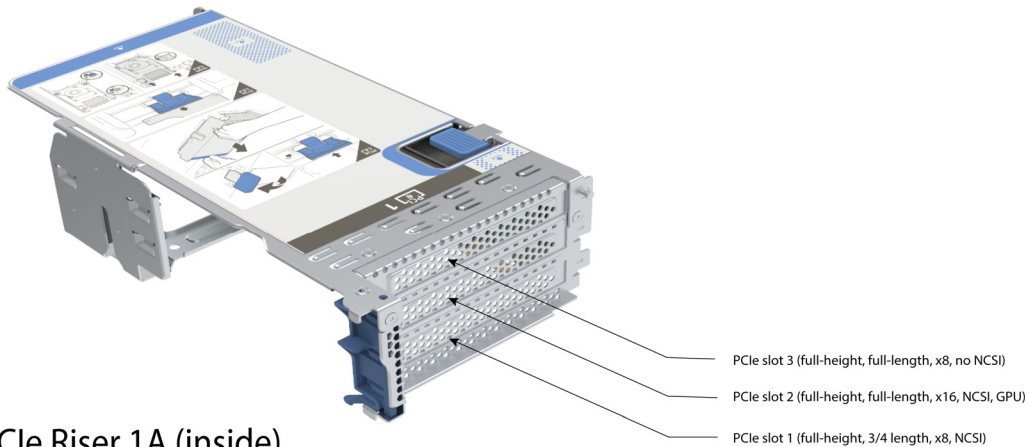

#### PCIe Riser 1A (inside)

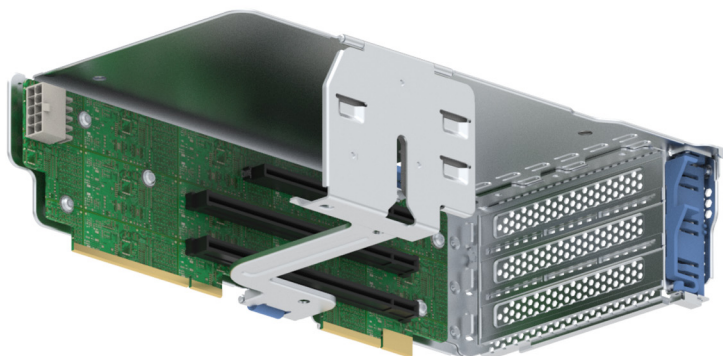

## Riser 1B

Riser 1B mechanical information is shown in [Figure 8](#).

Figure 8 Riser Card 1B

### PCIe Riser 1B (outside)

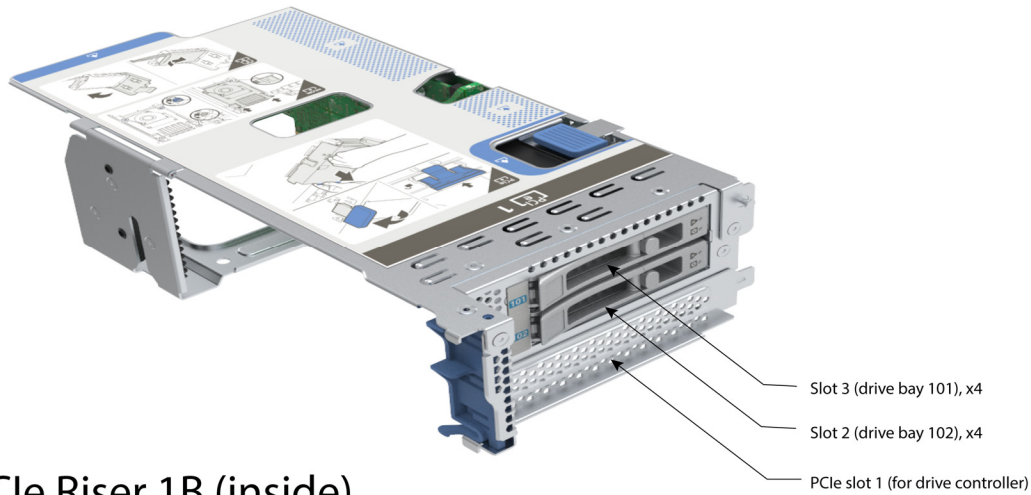

### PCIe Riser 1B (inside)



## Riser 2A

Riser 2A mechanical information is shown in [Figure 9](#).

Figure 9 Riser Card 2A

PCIe Riser 2A (outside)

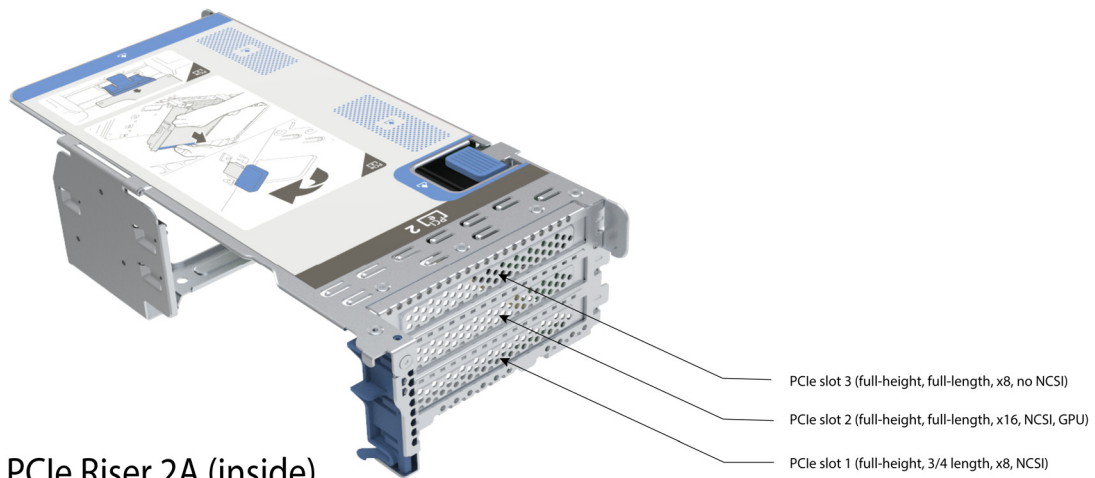

PCIe Riser 2A (inside)

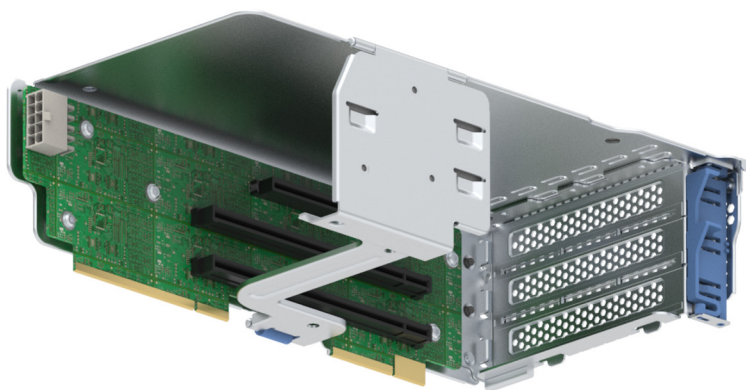

## Riser 3A

Riser 3A mechanical information is shown in [Figure 10](#).

Figure 10 Riser Card 3A

PCIe Riser 3A (outside)

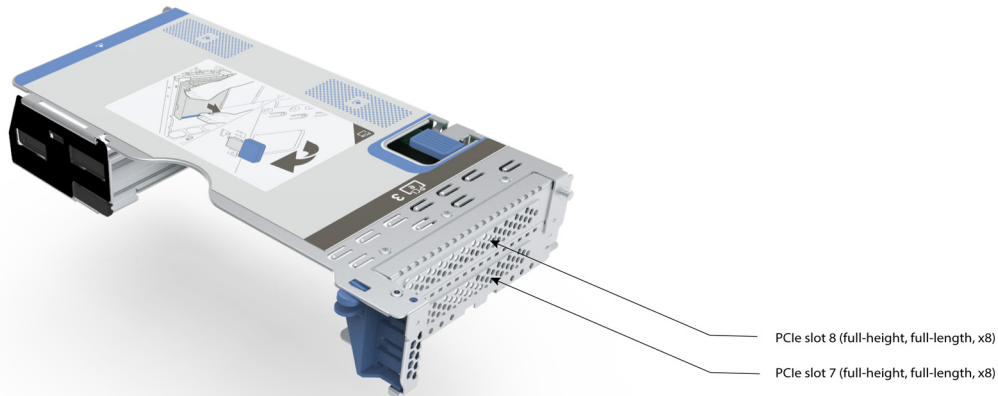

PCIe Riser 3A (inside)

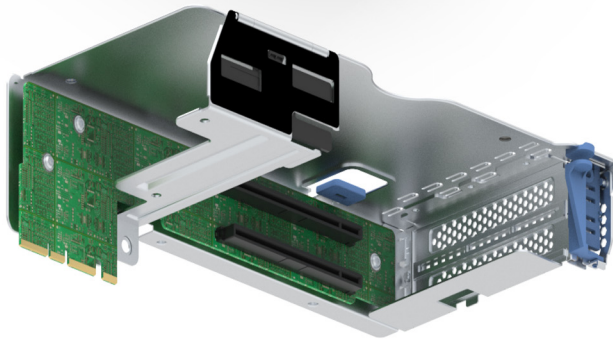

## Riser 3B

Riser 3B mechanical information is shown in [Figure 11](#).

Figure 11 Riser Card 3B

### PCIe Riser 3B (outside)

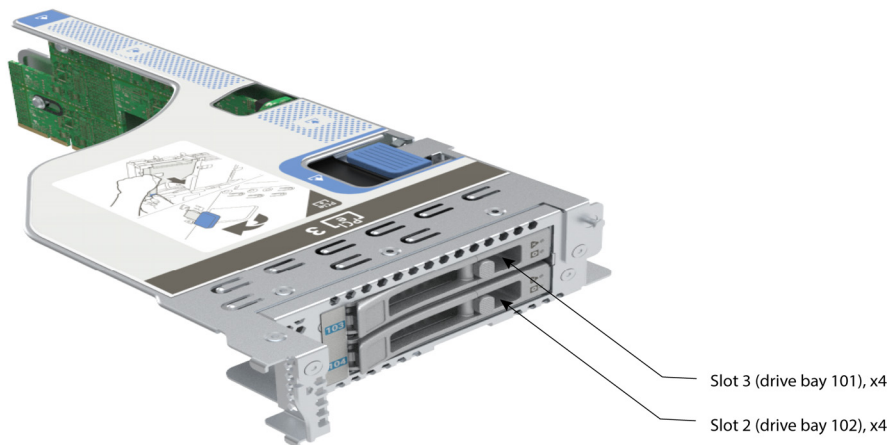

### PCIe Riser 3B (inside)

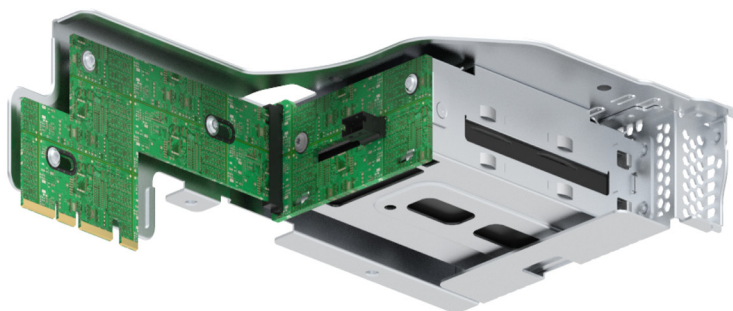

## Riser 3C

Riser 3C mechanical information is shown in [Figure 12](#).

Figure 12 Riser Card 3C

PCIe Riser 3C (outside)

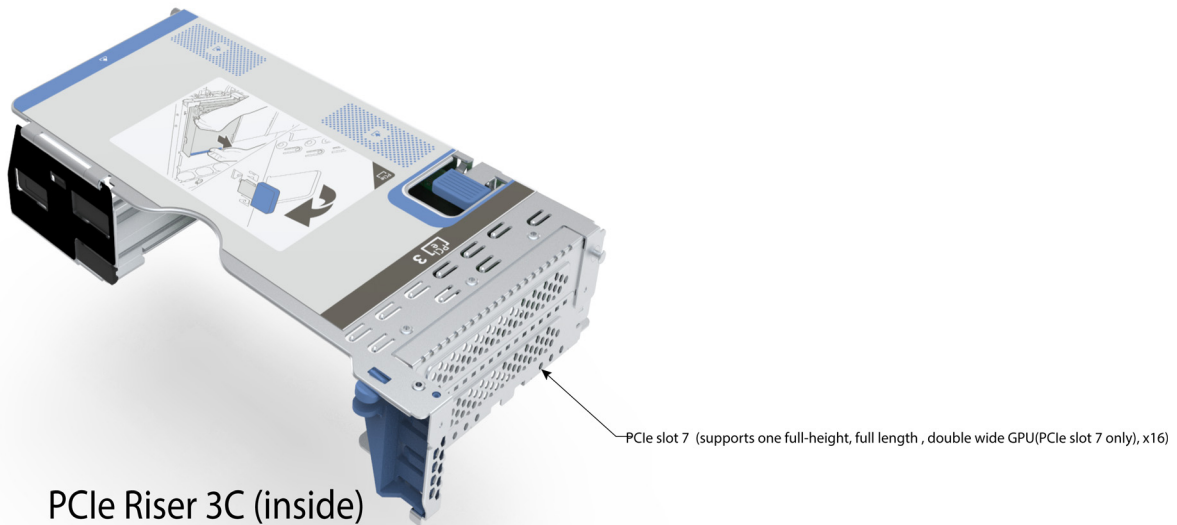

PCIe Riser 3C (inside)

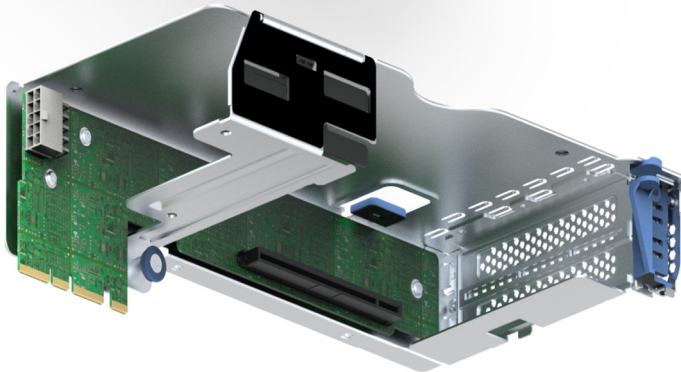

## Riser 3D

Riser 3D mechanical information is shown in [Figure 12](#).

Figure 13 Riser Card 3D

### PCIe Riser 3D (outside)

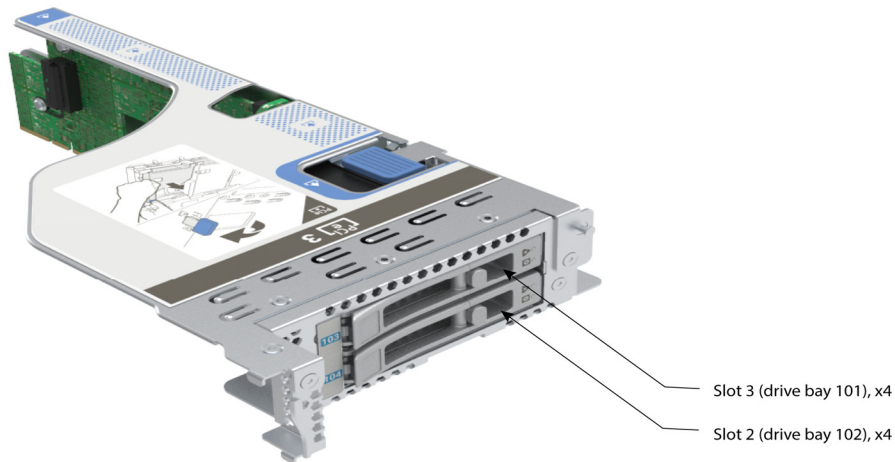

### PCIe Riser 3D (inside)

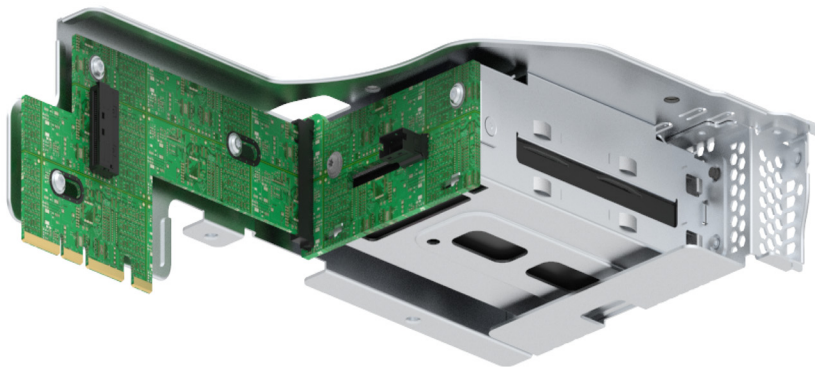

## Serial Port Details

The pinout details of the rear RJ-45 serial port connector are shown in [Figure 14](#).

**Figure 14** Serial Port (Female RJ-45 Connector) Pinout

### Serial Port (RJ-45 Female Connector)

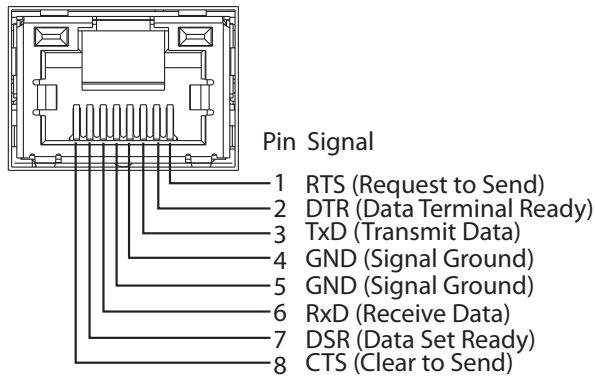

## KVM Cable

The KVM cable provides a connection into the server, providing a DB9 serial connector, a VGA connector for a monitor, and dual USB 2.0 ports for a keyboard and mouse. With this cable, you can create a direct connection to the operating system and the BIOS running on the server.

The KVM cable ordering information is listed in [Table 29](#).

**Table 29** KVM Cable

Product ID (PID)	PID Description
N20-BKVM	KVM cable for server console port

**Figure 15** KVM Cable

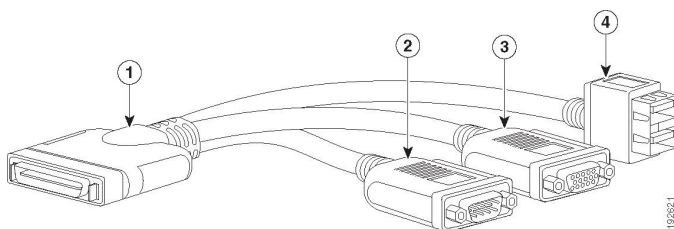

1	Connector (to server front panel)	3	VGA connector (for a monitor)
2	DB-9 serial connector	4	Two-port USB 2.0 connector (for a mouse and keyboard)



## REPLACING CPUs and HEATSINKS



**NOTE:** Before servicing any CPU, do the following:

- Decommission and power off the server.
- Slide the C245 M8 SFF server out from the rack.
- Remove the top cover.



**CAUTION:** CPUs and their sockets are fragile and must be handled with extreme care to avoid damaging pins. The CPUs must be installed with heatsinks and thermal interface material to ensure cooling. Failure to install a CPU correctly might result in damage to the server.



**CAUTION:** Always shut down the server before removing it from the chassis, as described in the procedures. Failure to shut down the server before removal results in the corresponding RAID supercap cache being discarded and other data might be lost.

To replace an existing CPU, follow these steps:

---

(1) Have the following tools and materials available for the procedure:

- T-20 Torx driver—Supplied with replacement CPU.
- Thermal interface material (TIM)—Syringe supplied with replacement CPU.

(2) Order the appropriate replacement CPU from [Table 5 on page 13](#)

(3) Carefully remove and replace the CPU and heatsink in accordance with the instructions found in “Cisco UCS C245 M8 Server Installation and Service Guide,” found at:

[https://www.cisco.com/content/en/us/td/docs/unified\\_computing/ucs/c/hw/c245m6/install/c245m6.html](https://www.cisco.com/content/en/us/td/docs/unified_computing/ucs/c/hw/c245m6/install/c245m6.html)

To add a new CPU, follow these steps:

---

(1) Have the following tools and materials available for the procedure:

- T-30 Torx driver—Supplied with new CPU.
- Thermal interface material (TIM)—Syringe supplied with replacement CPU.

(2) Order the appropriate new CPU from [Table 5 on page 13](#)

(3) Order one heat sink for each new CPU. Order PID UCSC-HSHP-245M8 unless you have installed a double-wide or A10 GPU. In that case, order PID UCSC-HSLP-245M6.

(4) Carefully install the CPU and heatsink in accordance with the instructions found in “Cisco UCS C240 M6 Server Installation and Service Guide,” found at:

[https://www.cisco.com/content/en/us/td/docs/unified\\_computing/ucs/c/hw/c245m6/install/c245m6.html](https://www.cisco.com/content/en/us/td/docs/unified_computing/ucs/c/hw/c245m6/install/c245m6.html)

## UPGRADING or REPLACING MEMORY



**NOTE:** Before servicing any DIMM, do the following:

- Decommission and power off the server.
- Remove the top cover from the server
- Slide the server out the front of the chassis.

To add or replace DIMMs, follow these steps:

Step 1 Open both DIMM connector latches.

Step 2 Press evenly on both ends of the DIMM until it clicks into place in its slot

Note: Ensure that the notch in the DIMM aligns with the slot. If the notch is misaligned, it is possible to damage the DIMM, the slot, or both.

Step 3 Press the DIMM connector latches inward slightly to seat them fully.

Step 4 Populate all slots with a DIMM or DIMM blank. A slot cannot be empty.

Figure 16 Replacing Memory

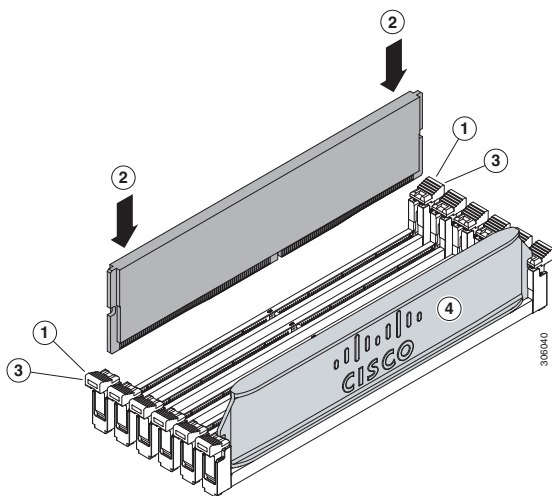

For additional details on replacing or upgrading DIMMs, see “Cisco UCS C240 M6 Server Installation and Service Guide,” found at these links:

[https://www.cisco.com/content/en/us/td/docs/unified\\_computing/ucs/c/hw/c245m6/install/c245m6.html](https://www.cisco.com/content/en/us/td/docs/unified_computing/ucs/c/hw/c245m6/install/c245m6.html)

# TECHNICAL SPECIFICATIONS

## Dimensions and Weight

Table 30 UCS C245 M8 Dimensions and Weight

Parameter	Value
Height	3.42 in. (8.7 cm)
Width (Not including slam latches)	16.9 in. (42.9 cm)
Width (including slam latches)	18.9 in. (48.0 cm)
Depth	30 in. (76.2 cm)
Front Clearance	3 in. (76 mm)
Side Clearance	1 in. (25 mm)
Rear Clearance	6 in. (152 mm)
Weight	
Weight with following options and no rail kit: 0 HDD, 0 CPU, 0 DIMM, and 1 2400 W power supply	35.7 lbs (16.2 kg)
Weight with following options and including rail kit: 0 HDD, 0 CPU, 0 DIMM, and 1 2400 W power supply	44 lbs (20 kg)
Weight with following options and no rail kit: 1 HDD, 1 CPU, 1 DIMM, and 1 2400 W power supply	37.6 lbs (17 kg)
Weight with following options and including rail kit: 1 HDD, 1 CPU, 1 DIMM, and 1 2400 W power supply	45.9 lbs (20.8 kg)
Weight with following options and no rail kit: 8 HDDs, 2 CPUs, 32 DIMMs, and 2 2400 W power supplies	44.71 lbs (20.28 kg)
Weight with following options and including rail kit: 8 HDDs, 2 CPUs, 32 DIMMs, and 2 2400 W power supplies	49.2 lbs (22.32 kg)
Weight with following options and no rail kit: 0 HDD, 0 CPU, 0 DIMM, and 1 2400 W power supply	33.14 lbs (15 kg)
Weight with following options and including rail kit: 0 HDD, 0 CPU, 0 DIMM, and 1 2400 W power supply	41.45 lbs (18.8 kg)
Weight with following options and no rail kit: 1 HDD, 1 CPU, 1 DIMM, and 1 2400 W power supply	40.55 lbs (18.4kg)
Weight with following options and including rail kit: 1 HDD, 1 CPU, 1 DIMM, and 1 2400 W power supply	48.86 lbs (22.2 kg)
Weight with following options and no rail kit: 24 HDDs, 2 CPUs, 32 DIMMs, and 2 2400 W power supplies	58.8 lbs (26.7 kg)

Table 30 UCS C245 M8 Dimensions and Weight

Parameter	Value
Weight with following options and including rail kit: 24 HDDs, 2 CPUs, 32 DIMMs, and 2 2400 W power supplies	61.7 lbs (28 kg)

## Power Specifications

The server is available with the following types of power supplies:

- 1050 W V2 (DC) power supply (see [Table 31](#)).
- 1200 W (AC) power supply (see [Table 32](#))
- 1600 W (AC) power supply (see [Table 33](#))
- 2300 W (AC) power supply (see [Table 34](#))

**Table 31 UCS C245 M8 SFF Power Specifications (1050 W V2 DC power supply)**

Parameter	Specification
Input Connector	Molex 42820
Input Voltage Range (V rms)	-48
Maximum Allowable Input Voltage Range (V rms)	-40 to -72
Frequency Range (Hz)	NA
Maximum Allowable Frequency Range (Hz)	NA
Maximum Rated Output (W)	1050
Maximum Rated Standby Output (W)	36
Nominal Input Voltage (V rms)	-48
Nominal Input Current (A rms)	24
Maximum Input at Nominal Input Voltage (W)	1154
Maximum Input at Nominal Input Voltage (VA)	1154
Minimum Rated Efficiency (%) <sup>1</sup>	91
Minimum Rated Power Factor <sup>1</sup>	NA
Maximum Inrush Current (A peak)	15
Maximum Inrush Current (ms)	0.2
Minimum Ride-Through Time (ms) <sup>2</sup>	5

**Notes:**

1. This is the minimum rating required to achieve 80 PLUS Platinum certification, see test reports published at <http://www.80plus.org/> for certified values
2. Time output voltage remains within regulation limits at 100% load, during input voltage dropout

Table 32 UCS C245 M8 1200 W (AC) Power Supply Specifications

Parameter	Specification			
Input Connector	IEC320 C14			
Input Voltage Range (Vrms)	100 to 240			
Maximum Allowable Input Voltage Range (Vrms)	90 to 264			
Frequency Range (Hz)	50 to 60			
Maximum Allowable Frequency Range (Hz)	47 to 63			
Maximum Rated Output (W) <sup>1</sup>	1100	1200		
Maximum Rated Standby Output (W)	48			
Nominal Input Voltage (Vrms)	100	120	208	230
Nominal Input Current (Arms)	12.97	10.62	6.47	5.84
Maximum Input at Nominal Input Voltage (W)	1300	1264	1343	1340
Maximum Input at Nominal Input Voltage (VA)	1300	1266	1345	1342
Minimum Rated Efficiency (%) <sup>2</sup>	90	90	91	91
Minimum Rated Power Factor <sup>2</sup>	0.97	0.97	0.97	0.97
Maximum Inrush Current (A peak)	20			
Maximum Inrush Current (ms)	0.2			
Minimum Ride-Through Time (ms) <sup>3</sup>	12			

**Notes:**

1. Maximum rated output is limited to 1100W when operating at low-line input voltage (100-127V)
2. This is the minimum rating required to achieve 80 PLUS Titanium certification, see test reports published at <http://www.80plus.org/> for certified values
3. Time output voltage remains within regulation limits at 100% load, during input voltage dropout

Table 33 UCS C245 M8 1600 W (AC) Power Supply Specifications

Parameter	Specification			
Input Connector	IEC320 C14			
Input Voltage Range (V rms)	200 to 240			
Maximum Allowable Input Voltage Range (V rms)	180 to 264			
Frequency Range (Hz)	50 to 60			
Maximum Allowable Frequency Range (Hz)	47 to 63			
Maximum Rated Output (W)	1600			
Maximum Rated Standby Output (W)	36			
Nominal Input Voltage (V rms)	100	120	208	230
Nominal Input Current (A rms)	NA	NA	8.8	7.9
Maximum Input at Nominal Input Voltage (W)	NA	NA	1778	1758
Maximum Input at Nominal Input Voltage (VA)	NA	NA	1833	1813
Minimum Rated Efficiency (%) <sup>1</sup>	NA	NA	90	91
Minimum Rated Power Factor <sup>2</sup>	NA	NA	0.97	0.97
Maximum Inrush Current (A peak)	30			
Maximum Inrush Current (ms)	0.2			
Minimum Ride-Through Time (ms) <sup>2</sup>	12			

Notes:

1. This is the minimum rating required to achieve 80 PLUS Platinum certification, see test reports published at <http://www.80plus.org/> for certified values
2. Time output voltage remains within regulation limits at 100% load, during input voltage dropout



Table 34 UCS C245 M8 2300 W (AC) Power Supply Specifications

Parameter	Specification			
Input Connector	IEC320 C20			
Input Voltage Range (Vrms)	100 to 240			
Maximum Allowable Input Voltage Range (Vrms)	90 to 264			
Frequency Range (Hz)	50 to 60			
Maximum Allowable Frequency Range (Hz)	47 to 63			
Maximum Rated Output (W) <sup>1</sup>	2300			
Maximum Rated Standby Output (W)	36			
Nominal Input Voltage (Vrms)	100	120	208	230
Nominal Input Current (Arms)	13	11	12	10.8
Maximum Input at Nominal Input Voltage (W)	1338	1330	2490	2480
Maximum Input at Nominal Input Voltage (VA)	1351	1343	2515	2505
Minimum Rated Efficiency (%) <sup>2</sup>	92	92	93	93
Minimum Rated Power Factor <sup>2</sup>	0.99	0.99	0.97	0.97
Maximum Inrush Current (A peak)	30			
Maximum Inrush Current (ms)	0.2			
Minimum Ride-Through Time (ms) <sup>3</sup>	12			

Notes:

1. Maximum rated output is limited to 1200W when operating at low-line input voltage (100-127V)
2. This is the minimum rating required to achieve 80 PLUS Titanium certification, see test reports published at <http://www.80plus.org/> for certified values
3. Time output voltage remains within regulation limits at 100% load, during input voltage dropout



**NOTE:** For configuration-specific power specifications, use the Cisco UCS Power Calculator at this URL: <http://ucspowercalc.cisco.com>

## Environmental Specifications

The environmental specifications for Cisco UCS C245 M8 SFF server are listed in [Table 35](#).

**Table 35 UCS C245 M8 Environmental Specifications**

Parameter	Minimum
Operating Temperature	5 °C to 35 °C (supports ASHRAE Class A4 and/or Class A3 and/or Class A2). ASHRAE Class A3 will be generic test profile unless otherwise specified by product engineering. System shall continue to operate with a single fan failure (one failed impeller in dual impeller housings) across the ASHRAE recommended operating range of 18 °C to 27 °C. While undesired, increased power consumption and/or acoustic noise is permitted during a fan fail event.
Non-Operating Temperature	Dry bulb temperature of -40 °C to 65 °C (-40 °F to 149 °F)
Operating Relative Humidity	8% to 90% relative humidity, non-condensing, with maximum wet bulb 28 °C (82.4 °F) within operational temperature range of 5 °C to 50 °C (41 °F to 122 °F)
Non-Operating Relative Humidity	5% to 93% relative humidity, non-condensing, with a maximum wet bulb temperature of 28 °C across the 20 °C to 40 °C dry bulb range.
Maximum Operating Duration	Unlimited
Operating Altitude	A maximum elevation of 3050 meters (10,006 ft)
Non-Operating Altitude	An elevation of 0 to 12,000 meters (39,370 ft)
Sound Power level, Measure A-weighted per ISO7779 LWAd (Bels) Operation at 23 °C (73 °F)	2RU: 5.8B Racked product: 6.8B
Sound Pressure level, Measure A-weighted per ISO7779 LpAm (dBA) Operation at 23 °C (73 °F)	2RU: 43dB Racked product: 55dB



## Compliance Requirements

The regulatory compliance requirements for C-Series servers are listed in [Table 36](#)

**Table 36 UCS C-Series Regulatory Compliance Requirements**

Parameter	Description
Regulatory Compliance	Products should comply with CE Markings per directives 2014/30/EU and 2014/35/EU
Safety	UL 60950-1 Second Edition CAN/CSA-C22.2 No. 60950-1 Second Edition EN 60950-1 Second Edition IEC 60950-1 Second Edition AS/NZS 60950-1 GB4943 2001
EMC - Emissions	47CFR Part 15 (CFR 47) Class A AS/NZS CISPR32 Class A CISPR32 Class A EN55032 Class A ICES003 Class A VCCI Class A EN61000-3-2 EN61000-3-3 KN32 Class A CNS13438 Class A
EMC - Immunity	EN55024 CISPR24 EN300386 KN35



**Americas Headquarters**  
Cisco Systems, Inc.  
San Jose, CA

**Asia Pacific Headquarters**  
Cisco Systems (USA) Pte. Ltd.  
Singapore

**Europe Headquarters**  
Cisco Systems International BV Amsterdam,  
The Netherlands

Cisco has more than 200 offices worldwide. Addresses, phone numbers, and fax numbers are listed on the Cisco Website at [www.cisco.com/go/offices](http://www.cisco.com/go/offices).

Cisco and the Cisco Logo are trademarks of Cisco Systems, Inc. and/or its affiliates in the U.S. and other countries. A listing of Cisco's trademarks can be found at [www.cisco.com/go/trademarks](http://www.cisco.com/go/trademarks). Third party trademarks mentioned are the property of their respective owners. The use of the word partner does not imply a partnership relationship between Cisco and any other company. (1005R)



