



This product has been discontinued

Spec Sheet

Cisco UCS C240 M5 Rack Server (Small Form Factor Disk Drive Model)

CISCO SYSTEMS
170 WEST TASMAN DR.
SAN JOSE, CA, 95134
WWW.CISCO.COM

PUBLICATION HISTORY

REV G.18 MAY 06, 2024

CONTENTS

OVERVIEW	3
DETAILED VIEWS	4
BASE SERVER STANDARD CAPABILITIES and FEATURES	8
CONFIGURING the SERVER	12
STEP 1 VERIFY SERVER SKU	13
STEP 2 SELECT RISER CARDS (REQUIRED)	14
STEP 3 SELECT CPU(s)	15
STEP 4 SELECT MEMORY	21
STEP 5 SELECT RAID CONTROLLERS	29
STEP 6 SELECT DRIVES	34
STEP 7 SELECT PCIe OPTION CARD(s)	44
STEP 8 ORDER OPTIONAL PCIe OPTION CARD ACCESSORIES	48
STEP 9 ORDER GPU CARDS (OPTIONAL)	53
STEP 10 ORDER POWER SUPPLY	55
STEP 11 SELECT INPUT POWER CORD(s)	56
STEP 12 ORDER TOOL-LESS RAIL KIT AND OPTIONAL REVERSIBLE CABLE MANAGEMENT ARM	60
STEP 13 SELECT MANAGEMENT CONFIGURATION (OPTIONAL)	61
STEP 14 SELECT SERVER BOOT MODE (OPTIONAL)	62
STEP 15 SELECT LOCKING SECURITY BEZEL (OPTIONAL)	63
STEP 16 ORDER SECURITY DEVICES (OPTIONAL)	64
STEP 17 ORDER OPTICAL DRIVE (OPTIONAL)	65
STEP 18 ORDER CISCO SD CARD MODULE (OPTIONAL)	66
STEP 19 ORDER M.2 SATA SSD (OPTIONAL)	67
STEP 20 ORDER INTERNAL MICRO-SD CARD MODULE (OPTIONAL)	69
STEP 21 ORDER OPTIONAL USB 3.0 DRIVE	70
STEP 22 SELECT OPERATING SYSTEM AND VALUE-ADDED SOFTWARE	71
STEP 23 SELECT OPERATING SYSTEM MEDIA KIT	75
STEP 24 SELECT SERVICE and SUPPORT LEVEL	76
SUPPLEMENTAL MATERIAL	84
SPARE PARTS	93
UPGRADING or REPLACING CPUs	107
UPGRADING or REPLACING MEMORY	108
DISCONTINUED EOL PRODUCTS	110
TECHNICAL SPECIFICATIONS	122

OVERVIEW

The UCS C240 M5 SFF server extends the capabilities of Cisco's Unified Computing System portfolio in a 2U form factor with the 2nd Generation Intel® Xeon® Scalable Processors, 3200 MHz DDR4 memory, and the new 512GB Intel® Optane™ Persistent Memory Modules (PMem). With this combination of features, up to 9 TB of memory is possible (using 12 x 256 GB DDR4 DIMMs and 12 x 512 GB PMem), up to 6 PCI Express (PCIe) 3.0 slots, and up to 26 internal SFF drives. The C240 M5 SFF server also includes one dedicated internal slot for a 12G SAS storage controller card.

The C240 M5 server includes a dedicated internal modular LAN on motherboard (mLOM) connector for installation of a Cisco Virtual Interface Card (VIC) or third-party network interface card (NIC), without consuming a PCI slot, in addition to 2 x 10Gbase-T Intel x550 embedded (on the motherboard) LOM ports.

The Cisco UCS C240 M5 server can be used standalone, or as part of the Cisco Unified Computing System, which unifies computing, networking, management, virtualization, and storage access into a single integrated architecture enabling end-to-end server visibility, management, and control in both bare metal and virtualized environments.

Figure 1 Cisco UCS C240 M5 SFF Rack Server (26-drive version)

Front View

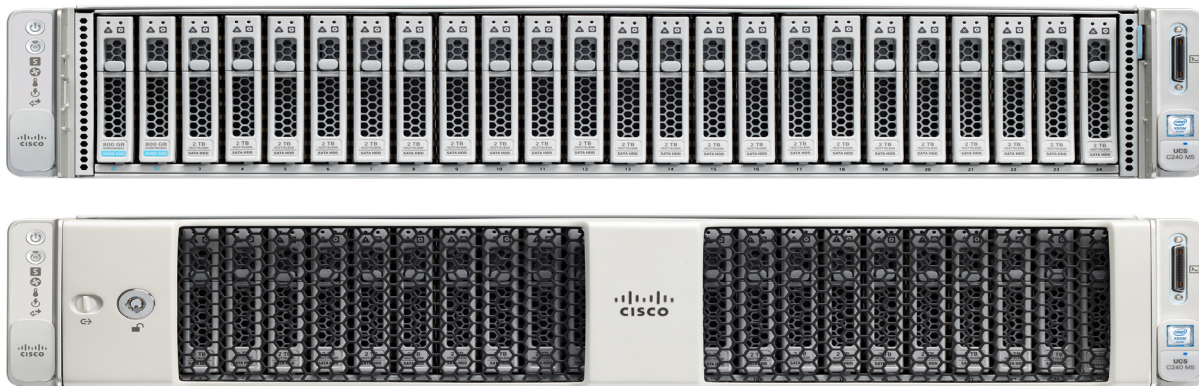

Rear View

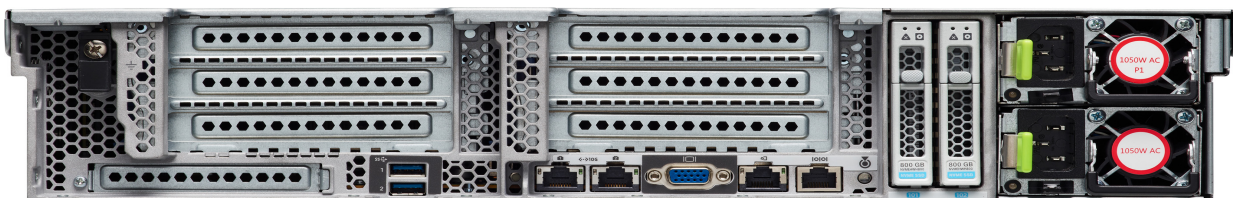

DETAILED VIEWS

Chassis Front View

Figure 2 shows the 26-drive Cisco UCS C240 M5 SFF Rack Server.

Figure 2 Chassis Front View (24 front drives, 2 rear drives version)

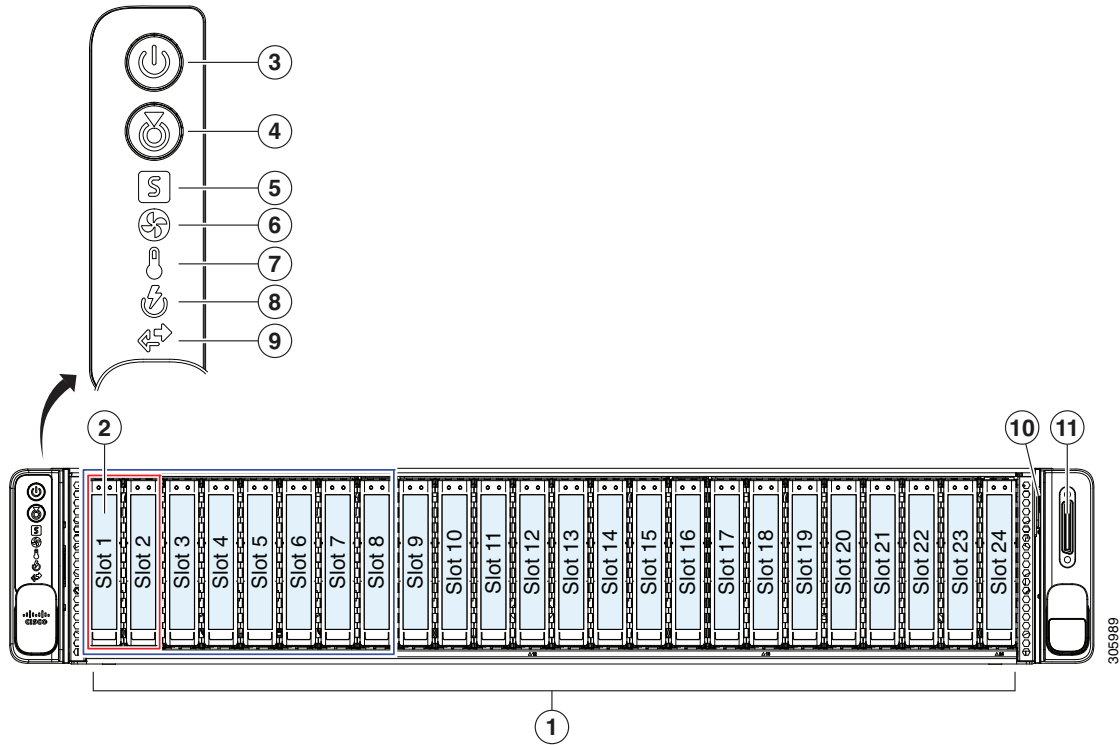

1	<ul style="list-style-type: none"> ■ UCSC-C240-M5SX: Drive bays 1–24 support 2.5-inch SAS/SATA drives. ■ UCSC-C240-M5SN: Drive bays 9–24 support 2.5-inch SAS/SATA drives. 	7	Temperature status LED
2	<ul style="list-style-type: none"> ■ UCSC-C240-M5SX: Drive bays 1 and 2 support NVMe PCIe SSDs. All bays support SAS/SATA drives ■ UCSC-C240-M5SN: Drive bays 1–8 support only NVMe PCIe SSDs. Bays 9–24 support only SAS/SATA drives 	8	Power supply status LED
3	Power button/Power status LED	9	Network link activity LED
4	Unit Identification button/LED	10	Pull-out asset tag
5	System status LED	11	KVM connector (used with KVM cable that provides two USB 2.0, one VGA, and one serial connector)
6	Fan status LED		

Figure 3 shows the 10-drive Cisco UCS C240 M5 SFF Rack Server.

Figure 3 Chassis Front View (8 front drives, 2 rear drives version)

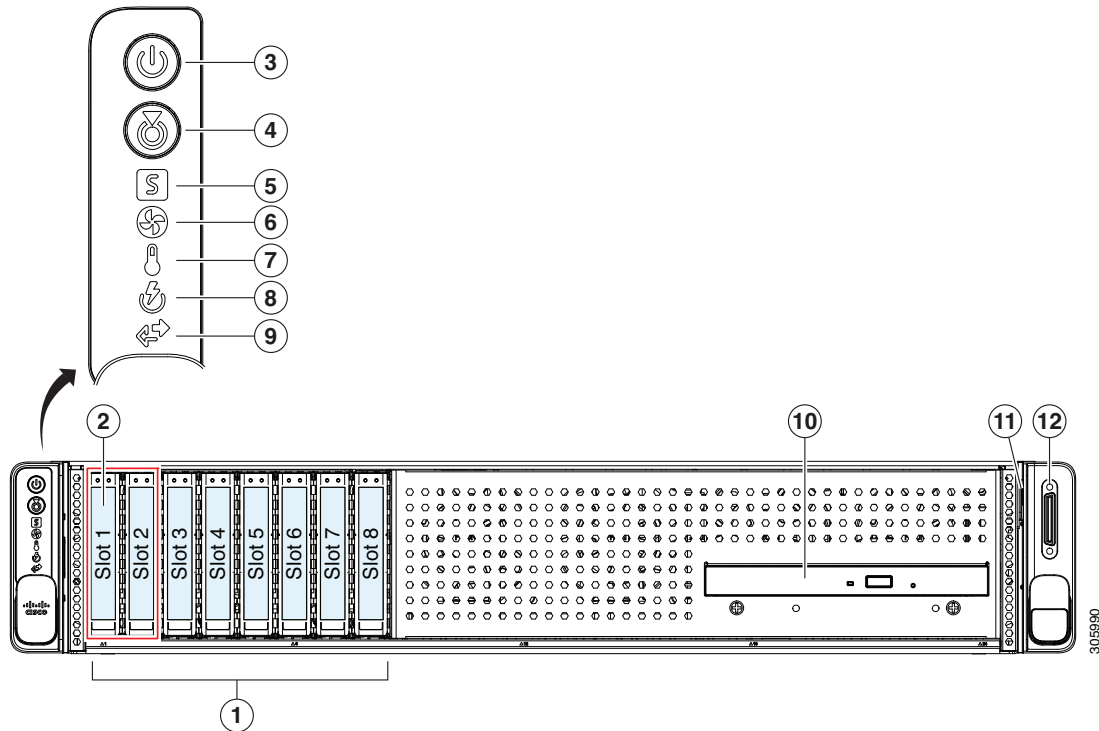

1	UCSC-C240-M5S: Drive bays 1–8 support SAS/SATA drives.	7	Temperature status LED
2	UCSC-C240-M5S: Drive bays 1 and 2 support NVMe PCIe SSDs.	8	Power supply status LED
3	Power button/Power status LED	9	Network link activity LED
4	Unit Identification button/LED	10	Optional media drive (DVD)
5	System status LED	11	Pull-out asset tag
6	Fan status LED	12	KVM connector (used with KVM cable that provides two USB 2.0, one VGA, and one serial connector)

Chassis Rear View

Figure 4 shows the external features of the rear panel (identical for all server versions).

Figure 4 Chassis Rear View

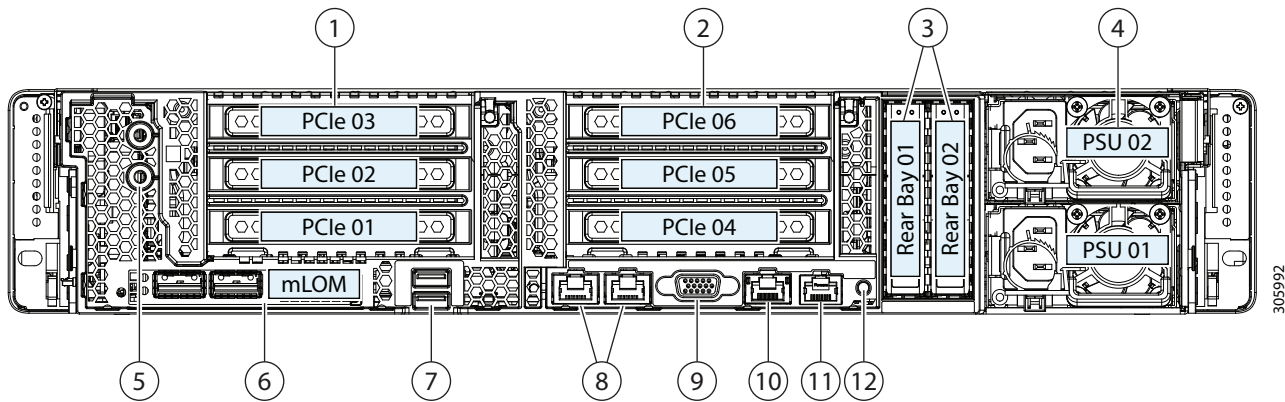

<p>1</p>	<p>PCIe riser 1 (slots 1, 2, 3) Two options:</p> <ul style="list-style-type: none"> ■ Riser 1 option <ul style="list-style-type: none"> • slot 1 (x8, CPU1 controlled) • slot 2 (x16, CPU1 controlled) • slot 3 (x8, CPU2 controlled) ■ Riser 1B option <ul style="list-style-type: none"> • slot 1 (x8, CPU1 controlled) • slot 2 (x8, CPU1 controlled) • slot 3 (x8, CPU1 controlled) <p>See Riser Card Configuration and Options, page 84 for details.</p>	<p>7</p>	<p>USB 3.0 ports (two)</p>
<p>2</p>	<p>PCIe riser 2 (slots 4, 5, 6) Four options:</p> <ul style="list-style-type: none"> ■ Riser 2A option <ul style="list-style-type: none"> • slot 4 (x16, CPU2 controlled) • slot 5 (x16, CPU2 controlled) • slot 6 (x8, CPU2 controlled) 	<p>8</p>	<p>Dual 1/10 GB Ethernet ports (LAN1, LAN2) LAN1 is left connector, LAN2 is right connector</p>

<p>2 (cont.)</p>	<ul style="list-style-type: none"> ■ Riser 2B option <ul style="list-style-type: none"> • slot 4 (x8, CPU2 controlled) • slot 5 (x16, CPU2 controlled) • slot 6 (x8, CPU2 controlled) • One x8 NVMe connector (for two rear NVMe drives) from slot 4 ■ Riser 2C option <ul style="list-style-type: none"> • slot 4 (x8, CPU2 controlled) • slot 5 (x8, CPU2 controlled) • slot 6 (x8, CPU2 controlled) • Two x8 NVMe connectors (for two front NVMe and two rear NVMe drives) from slots 4 and 5 ■ Riser 2D option (always ships with UCSC- C240-M5SN) <ul style="list-style-type: none"> • slot 4 (x16, CPU2 controlled) • slot 5 (x8, CPU2 controlled) • slot 6 (x8, CPU2 controlled) • One NVMe connector (for two rear drives) from slot 6 <p>See Riser Card Configuration and Options, page 84 for details.</p>		
<p>3</p>	<p>Rear 2.5-inch drive bays:</p> <ul style="list-style-type: none"> ■ Server PID UCSC-C240-M5SN supports up to two NVMe PCIe SSDs (only), controlled by Riser 2. ■ All other C240 M5 PIDs support up to two rear drives: <ul style="list-style-type: none"> • When using a hardware RAID controller card in the server, SAS/SATA drives or NVMe SSDs are supported in the rear bays. • When using software RAID in the server, only NVMe SSDs are supported in the rear bays, controlled by Riser 2. 	<p>9</p>	<p>VGA video port (DB-15 connector)</p>
<p>4</p>	<p>Power supplies (two, redundant as 1+1)</p>	<p>10</p>	<p>1-Gb Ethernet dedicated management port</p>
<p>5</p>	<p>Screw holes for dual-hole grounding lug</p>	<p>11</p>	<p>Serial port (RJ-45 connector)</p>
<p>6</p>	<p>Modular LAN-on-motherboard (mLOM) card slot (x16)</p>	<p>12</p>	<p>Rear Unit Identification button/LED</p>

BASE SERVER STANDARD CAPABILITIES and FEATURES

Table 1 lists the capabilities and features of the base server. Details about how to configure the server for a particular feature or capability (for example, number of processors, disk drives, or amount of memory) are provided in *CONFIGURING the SERVER, page 12*.

Table 1 Capabilities and Features

Capability/Feature	Description
Chassis	Two rack unit (2RU) chassis
CPU	One or two 2 nd Generation Intel® Xeon® scalable family CPUs
Chipset	Intel® C621 series chipset
Memory	24 slots for registered DIMMs (RDIMMs), load-reduced DIMMs (LRDIMMs), or through silicon via (TSV) DIMMs and support for Intel® Optane™ Persistent Memory (PMem)
Multi-bit Error Protection	This server supports multi-bit error protection.
Video	The Cisco Integrated Management Controller (CIMC) provides video using the Matrox G200e video/graphics controller: <ul style="list-style-type: none"> ■ Integrated 2D graphics core with hardware acceleration ■ 512MB total DDR4 memory, with 16MB dedicated to Matrox video memory ■ Supports display resolutions up to 1920 x 1200 16bpp @ 60Hz ■ High-speed integrated 24-bit RAMDAC ■ Single lane PCI-Express host interface running at Gen 1 speed
SATA Interposer Board	An optional SATA interposer board supports up to eight front facing SATA-only drives.
Power subsystem	Up to two of the following hot-swappable power supplies: <ul style="list-style-type: none"> ■ 770 W (AC) ■ 1050 W (AC) ■ 1050 W (DC) ■ 1600 W (AC) One power supply is mandatory; one more can be added for 1 + 1 redundancy.
Front Panel	A front panel controller provides status indications and control buttons.
ACPI	This server supports the advanced configuration and power interface (ACPI) 6.2 standard.
Fans	<ul style="list-style-type: none"> ■ Six hot-swappable fans for front-to-rear cooling
Infiniband	The InfiniBand architecture is supported by the PCIe slots.

Capability/ Feature	Description
Expansion slots	<p>Up to six PCIe slots (on two riser cards)</p> <ul style="list-style-type: none"> ■ Riser 1 (PCIe slots 1, 2, and 3), controlled by CPU 1 and CPU 2 <ul style="list-style-type: none"> • Option 1A: three slots available. <ul style="list-style-type: none"> Slot 1 = full height, 3/4 length, x8, 230 pins, CPU1, NCSI support. Slot 2 = full height, full length, x16, 230 pins, CPU1, NCSI and GPU support. Slot 3 = full height, half length, x8, 164 pins, CPU2. • Option 1B: three slots available. <ul style="list-style-type: none"> Slot 1 = full height, 3/4 length, x8, 230 pins, CPU1, NCSI support. Slot 2 = full height, full length, x8, 230 pins, CPU1, NCSI support. Slot 3 = full height, full length, x8, 164 pins, CPU1. ■ Riser 2 (PCIe slots 4, 5, and 6), all controlled by CPU 2. Three slots available. <ul style="list-style-type: none"> • Option 2A: three slots available <ul style="list-style-type: none"> Slot 4 = full height, 3/4 length, x16, 230 pins, NCSI support. Slot 5 = full height, full length, x16, 230 pins, NCSI and GPU support. Slot 6 = full height, full length, x8, 164 pins. • Option 2B: three slots available <ul style="list-style-type: none"> Slot 4 = full height, 3/4 length, x8, 230 pins, NCSI support. Slot 5 = full height, full length, x16, 230 pins, NCSI and GPU support. Slot 6 = full height, full length, x8, 164 pins. One connector for two rear SFF NVMe drives (from slot 4) • Option 2C: three slots available <ul style="list-style-type: none"> Slot 4 = full height, 3/4 length, x8, 230 pins, NCSI support. Slot 5 = full height, full length, x8, 230 pins, NCSI and GPU support. Slot 6 = full height, full length, x8, 164 pins. One connector for two rear 2.5 inch NVMe drives (from slot 4) and one connector for two front 2.5 inch NVMe drives (from slot 5) • Option 2D: three slots available (always ships with UCSC-C240-M5SN, not available for other chassis versions) <ul style="list-style-type: none"> Slot 4 = full height, 3/4 length, x16, 164 pins, NCSI support. Also supports PCIe switch card for supporting 8 front 2.5 NVMe drives Slot 5 = full height, full length, x8, 230 pins, NCSI support. Slot 6 = full height, full length, x8, 164 pins. One connector for two rear 2.5 inch NVMe drives (from slot 6) ■ Dedicated RAID controller slot (see Figure 6 on page 78) <ul style="list-style-type: none"> • An internal slot is reserved for the Cisco 12G SAS RAID controller or the Cisco 12G SAS HBA. <p>For more details on riser 1 and riser 2 see Riser Card Configuration and Options, page 84.</p>

Capability/ Feature	Description
Internal storage devices	<ul style="list-style-type: none"> ■ UCSC-C240-M5SX: <ul style="list-style-type: none"> • 24 SFF front-facing SAS/SATA hard drives (HDDs) or SAS/SATA solid state drives (SSDs). • Optionally, up to two front-facing SFF NVMe PCIe SSDs (replacing SAS/SATA drives). These drives must be placed in front drive bays 1 and 2 only and are controlled from Riser 2 option C. • Optionally, up to two SFF, rear-facing SAS/SATA HDDs/SSDs or up to two rear-facing SFF NVMe PCIe SSDs. Rear facing SFF NVMe drives are connected from Riser 2, Option B or C. ■ UCSC-C240-M5SN: <ul style="list-style-type: none"> • Up to eight front-facing SFF NVMe PCIe SSDs only (replacing SAS/SATA drives). These drives must be placed in front drive bays 1 through 8 only and are connected from Riser 2 slot 4 (from a PCIe switch). • 16 SFF front-facing SAS/SATA hard drives (HDDs) or SAS/SATA solid state drives (SSDs). Drives occupy slots 9-24. • Optionally, up to two SFF, rear-facing SFF NVMe PCIe SSDs (must be NVMe only).Rear facing NVMe drives are connected from Riser 2. ■ UCSC-C240-M5S: <ul style="list-style-type: none"> • Eight SFF, front-facing SAS/SATA HDDs or SSDs. • Optionally, up to two front-facing NVMe PCIe SSDs (replacing SAS/SATA drives). These drives must be placed in front drive bays 1 and 2 only and are controlled from Riser 2 option C. • Optionally, up to two SFF, rear-facing SAS/SATA HDDs/SSDs or up to two rear-facing SFF NVMe PCIe SSDs. Rear facing SFF NVMe drives are connected from Riser 2, Option B or C. • Optionally, one front-facing DVD drive
	<ul style="list-style-type: none"> ■ One internal USB 3.0 port on the motherboard that you can use with an optional 16 GB USB thumb drive for additional storage. ■ A mini-storage module connector on the motherboard supports either: <ul style="list-style-type: none"> • An SD card module with two SD card slots. Mixing different capacity SD cards is not supported, or • An M.2 module with two SATA M.2 SSD slots.Mixing different capacity M.2 modules is not supported. <hr/> <div style="display: flex; align-items: center;">  <p>NOTE: SD cards and M.2 SSDs cannot be mixed. See details for RAID functionality in the ORDER M.2 SATA SSD (OPTIONAL) section.</p> </div> <hr/>
	<ul style="list-style-type: none"> ■ One slot for a micro-SD card on PCIe Riser 1 (Option 1 and 1B). The micro-SD card serves as a dedicated local resource for utilities such as HUU. Images can be pulled from a file share (NFS/CIFS) and uploaded to the cards for future use

Capability/ Feature	Description
I/O Interfaces	<ul style="list-style-type: none"> ■ Rear panel <ul style="list-style-type: none"> • One 1Gbase-T RJ-45 management port (Marvell 88E6176) • Two 10Gbase-T LOM ports (Intel X550 controller embedded on the motherboard) • One RS-232 serial port (RJ45 connector) • One DB15 VGA connector • Two USB 3.0 port connectors • One flexible modular LAN on motherboard (mLOM) slot that can accommodate various interface cards ■ Front panel <ul style="list-style-type: none"> • One KVM console connector (supplies two USB 2.0 connectors, one VGA DB15 video connector, and one serial port (RS232))
Storage controller	<ul style="list-style-type: none"> ■ Embedded RAID (software RAID) <ul style="list-style-type: none"> • Supports up to 8 SATA-only drives • Requires a SATA interposer board ■ Cisco 12G SAS RAID controller card with internal SAS connectivity. <ul style="list-style-type: none"> • Supports up to 26 internal SAS/SATA drives • Plugs into a dedicated RAID controller slot • Supports RAID 0, 1, 5, 6, 10, 50, 60 or JBOD mode ■ Cisco 12G SAS HBA (JBOD/Pass-through Mode) <ul style="list-style-type: none"> • Supports up to 26 SAS/SATA internal drives • Plugs into the dedicated RAID controller slot ■ Cisco 12G 9400-8e SAS HBA <ul style="list-style-type: none"> • Supports external JBOD attach • Plugs into an appropriate riser slot (up to two are supported) • No RAID support
Modular LAN on Motherboard (mLOM) slot	<p>The dedicated mLOM slot on the motherboard can flexibly accommodate the following cards:</p> <ul style="list-style-type: none"> ■ Cisco Virtual Interface Cards ■ Quad Port Intel i350 1GbE RJ45 mLOM Network Interface Card (NIC) <hr/> <p> NOTE: The four Intel i350 ports are provided on an optional card that plugs into the mLOM slot, and are separate from the two embedded (on the motherboard) LAN ports</p>
Integrated management processor	<p>Baseboard Management Controller (BMC) running Cisco Integrated Management Controller (CIMC) firmware.</p> <p>Depending on your CIMC settings, the CIMC can be accessed through the 1GE dedicated management port, the 1GE/10GE LOM ports, or a Cisco virtual interface card (VIC).</p> <p>CIMC manages certain components within the server, such as the Cisco 12G SAS HBA.</p>
UCSM	<p>UCS Manager (UCSM) runs in the Fabric Interconnect and automatically discovers and provisions some of the server components.</p>

CONFIGURING the SERVER

Follow these steps to configure the Cisco UCS C240 M5 SFF Rack Server:

- *STEP 1 VERIFY SERVER SKU, page 13*
- *STEP 2 SELECT RISER CARDS (REQUIRED), page 14*
- *STEP 3 SELECT CPU(s), page 15*
- *STEP 4 SELECT MEMORY, page 21*
- *STEP 5 SELECT RAID CONTROLLERS, page 28*
- *STEP 6 SELECT DRIVES, page 33*
- *STEP 7 SELECT PCIe OPTION CARD(s), page 42*
- *STEP 8 ORDER OPTIONAL PCIe OPTION CARD ACCESSORIES, page 46*
- *STEP 9 ORDER GPU CARDS (OPTIONAL), page 47*
- *STEP 10 ORDER POWER SUPPLY, page 49*
- *STEP 11 SELECT INPUT POWER CORD(s), page 50*
- *STEP 12 ORDER TOOL-LESS RAIL KIT AND OPTIONAL REVERSIBLE CABLE MANAGEMENT ARM, page 54*
- *STEP 13 SELECT MANAGEMENT CONFIGURATION (OPTIONAL), page 55*
- *STEP 14 SELECT SERVER BOOT MODE (OPTIONAL), page 56*
- *STEP 15 SELECT LOCKING SECURITY BEZEL (OPTIONAL), page 57*
- *STEP 16 ORDER SECURITY DEVICES (OPTIONAL), page 58*
- *STEP 17 ORDER OPTICAL DRIVE (OPTIONAL), page 59*
- *STEP 18 ORDER CISCO SD CARD MODULE (OPTIONAL), page 60*
- *STEP 19 ORDER M.2 SATA SSD (OPTIONAL), page 61*
- *STEP 20 ORDER INTERNAL MICRO-SD CARD MODULE (OPTIONAL), page 63*
- *STEP 21 ORDER OPTIONAL USB 3.0 DRIVE, page 64*
- *STEP 22 SELECT OPERATING SYSTEM AND VALUE-ADDED SOFTWARE, page 65*
- *STEP 23 SELECT OPERATING SYSTEM MEDIA KIT, page 69*
- *STEP 24 SELECT SERVICE and SUPPORT LEVEL, page 70*

STEP 1 VERIFY SERVER SKU

Select one server product ID (PID) from [Table 2](#).

Table 2 PID of the C240 M5 SFF Rack Base Server

Product ID (PID)	Description
UCSC-C240-M5SX	<p>Small form-factor (SFF) drives, with 24-drive backplane.</p> <ul style="list-style-type: none"> ■ Front-loading drive bays 1–24 support 2.5-inch SAS/SATA drives. ■ Optionally, front-loading drive bays 1 and 2 support 2.5-inch NVMe SSDs. ■ Optionally, the two rear-loading drive bays support up to two 2.5-inch SAS/SATA drives; or up to two 2.5-inch NVMe SSDs. ■ No CPU, memory, drives, PCIe cards, or power supply included
UCSC-C240-M5S	<p>SFF drives, with 8-drive backplane and DVD drive option.</p> <ul style="list-style-type: none"> ■ Front-loading drive bays 1–8 support 2.5-inch SAS/SATA drives. ■ Optionally, front-loading drive bays 1 and 2 support 2.5-inch NVMe SSDs. ■ Optionally, the two rear-loading drive bays support up to two 2.5-inch SAS/SATA drives; or up to two 2.5-inch NVMe SSDs. ■ No CPU, memory, drives, PCIe cards, or power supply included
UCSC-C240-M5SN	<p>SFF drives, with 24-drive backplane, NVMe-optimized.</p> <ul style="list-style-type: none"> ■ Front-loading drive bays 1–8 support 2.5-inch NVMe PCIe SSDs only. ■ Front-loading drive bays 9–24 support 2.5-inch SAS/SATA drives. ■ The two rear-loading drive bays support up to two 2.5-inch NVMe SSDs only. ■ No CPU, memory, drives, PCIe cards, or power supply included

The Cisco UCS C240 M5 server:

- Includes either a 24- or 8-drive backplane.



NOTE: The C240 M5 SFF server hard drive backplane is not field upgradeable. This means, for example, that you cannot “upgrade” from the 8-drive backplane version to the 24-drive backplane version. Likewise, the backplane is not field “downgradeable.”

- Does not include power supply, CPU, memory (DIMMs or PMem), hard disk drives (HDDs), solid-state drives (SSDs), NVMe drives, SD cards, riser 1, riser 2, tool-less rail kit, or PCIe cards.



NOTE: Use the steps on the following pages to configure the server with the components that you want to include.

STEP 2 SELECT RISER CARDS (REQUIRED)

There are two riser cards per server, riser card 1 and 2. There are two options for riser card 1 (1 and 1B) and four options for riser card 2 (2A, 2B, 2C, and 2D). Riser 2D always ships with UCSC-C240-M5SN and is not supported with any other chassis version. Order one riser card 1 and/or one riser 2 card from [Table 3](#). Riser card 1 is the one on the left when viewed from the back of the server and riser card 2 is on the right.

Table 3 Riser 1 required

Product ID (PID)	Description
PCIe Riser 1 required	
UCSC-PCI-1-C240M5	Riser 1. Includes 3 PCIe slots (x8, x16, x8). Slots 1 and 2 controlled with CPU1; slot 3 controlled with CPU2.
UCSC-PCI-1B-240M5	Riser 1B. Includes 3 PCIe slots (x8, x8, x8). All slots controlled with CPU1.
UCSC-RIS-1-240M5	Riser 1 3PCIe slots (x8, x16, x8); slot 3 req CPU2, For T4
UCSC-RIS-1B-240M5	Riser 1B 3PCIe slots (x8, x8, x8); all from CPU1, For T4
UCSC-R1-A100-M5	Riser1 3PCIe slots(x8, x16, x8) For A100
PCIe Riser 2 options (all slots controlled with CPU2)	
UCSC-PCI-2A-240M5	Riser 2A. Includes 3 PCIe slots (x16, x16, x8) and supports a GPU.
UCSC-PCI-2B-240M5	Riser 2B. Includes 3 PCIe slots (x8, x16, x8) plus 1 NVMe connector (controls two rear SFF NVMe drives) and supports a GPU.
UCSC-PCI-2C-240M5	Riser 2C. Includes 3 PCIe slots (x8, x8, x8) plus 2 NVMe connectors (one connector for two front SFF NVMe drives and one connector for two rear SFF NVMe drives).
UCSC-RIS-2A-240M5	Riser 2A 3PCIe slots (x8, x16, x16) supports GPU, For T4
UCSC-RIS-2B-240M5	Riser 2B 3PCIe slot(x8, x16, x8) supports GPU+rear NVMe, For T4
UCSC-RIS-2C-240M5	Riser 2C 3PCIe slots (3 x8) supports front+rear NVMe, For T4
UCSC-R2A-A100-M5	Riser2A 3PCIe slots (x8, x16, x16) For A100
UCSC-R2B-A100-M5	Riser2B 3PCIe slot(x8,x16,x8) supports GPU+NVMe, For A100



NOTE:

- Riser 1 is required to be ordered
- If no riser 2 option is selected, a riser blanking panel will be installed that covers PCIe slots 4, 5, and 6. You will not be able to install any PCIe cards in PCIe slots 4, 5, or 6 if the riser 2 option is not selected. You can order a spare riser 2 blanking panel (UCSC-PCIF-240M5=)
- If there is any PCIe slot that does not have a card installed, you must order a blanking panel for that slot (UCSC-PCIF-01F=).
- UCSC-C240-M5SN only supports GPU on Riser 1

For additional details, see [Riser Card Configuration and Options, page 84](#).

STEP 3 SELECT CPU(s)

The standard CPU features are:

- 2nd Generation Intel® Xeon® scalable family CPUs
- Intel® C621 series chipset
- Cache size of up to 38.5 MB

Select CPUs

The available CPUs are listed in [Table 4](#).

Table 4 Available CPUs

Product ID (PID)	Clock Freq (GHz)	Power (W)	Cache Size (MB)	Cores	UPI ¹ Links (GT/s)	Highest DDR4 DIMM Clock Support (MHz) ²	Workload/Processor type
Cisco Recommended CPUs (2nd Generation Intel® Xeon® Processors)							
UCS-CPU-I8276	2.2	165	38.50	28	3 x 10.4	2933	Oracle, SAP
UCS-CPU-I8260	2.4	165	35.75	24	3 x 10.4	2933	Microsoft Azure Stack
UCS-CPU-I6262V	1.9	135	33.00	24	3 x 10.4	2400	Virtual Server infrastructure or VSI
UCS-CPU-I6248R	3.0	205	35.75	24	2 x 10.4	2933	
UCS-CPU-I6248	2.5	150	27.50	20	3 x 10.4	2933	VDI, Oracle, SQL, Microsoft Azure Stack
UCS-CPU-I6238R	2.2	165	38.50	28	2 x 10.4	2933	Oracle, SAP (2-Socket TDI only), Microsoft AzureStack
UCS-CPU-I6238	2.1	140	30.25	22	3 x 10.4	2933	SAP
UCS-CPU-I6230R	2.1	150	35.75	26	2 x 10.4	2933	Virtual Server Infrastructure, Data Protection, Big Data, Splunk, Microsoft AzureStack
UCS-CPU-I6230	2.1	125	27.50	20	3 x 10.4	2933	Big Data, Virtualization
UCS-CPU-I5220R	2.2	125	35.75	24	2 x 10.4	2666	Virtual Server Infrastructure, Splunk, Microsoft Azure Stack
UCS-CPU-I5220	2.2	125	24.75	18	2 x 10.4	2666	HCI
UCS-CPU-I5218R	2.1	125	27.50	20	2 x 10.4	2666	Virtual Server Infrastructure, Data Protection, Big Data, Splunk, Scale-out Object Storage, Microsoft AzureStack

Table 4 Available CPUs

Product ID (PID)	Clock Freq (GHz)	Power (W)	Cache Size (MB)	Cores	UPI ¹ Links (GT/s)	Highest DDR4 DIMM Clock Support (MHz) ²	Workload/Processor type
UCS-CPU-I5218	2.3	125	22.00	16	2 x 10.4	2666	Virtualization, Microsoft Azure Stack, Splunk, Data Protection
UCS-CPU-I4216	2.1	100	22.00	16	2 x 9.6	2400	Data Protection, Scale Out Storage
UCS-CPU-I4214R	2.4	100	16.50	12	2 x 9.6	2400	Data Protection, Splunk, Scale-out Object Storage, Microsoft AzureStack
UCS-CPU-I4214	2.2	85	16.50	12	2 x 9.6	2400	Data Protection, Scale Out Storage
UCS-CPU-I4210R	2.4	100	13.75	10	2 x 9.6	2400	Virtual Server Infrastructure, Data Protection, Big Data, Splunk
UCS-CPU-I4210	2.2	85	13.75	10	2 x 9.6	2400	Virtualization, Big Data, Splunk
8000 Series Processor							
UCS-CPU-I8280L	2.7	205	38.50	28	3 x 10.4	2933	2 nd Gen Intel® Xeon®
UCS-CPU-I8280	2.7	205	38.50	28	3 x 10.4	2933	2 nd Gen Intel® Xeon®
UCS-CPU-I8276L	2.2	165	38.50	28	3 x 10.4	2933	2 nd Gen Intel® Xeon®
UCS-CPU-I8276	2.2	165	38.50	28	3 x 10.4	2933	2 nd Gen Intel® Xeon®
UCS-CPU-I8270	2.7	205	35.75	26	3 x 10.4	2933	2 nd Gen Intel® Xeon®
UCS-CPU-I8268	2.9	205	35.75	24	3 x 10.4	2933	2 nd Gen Intel® Xeon®
UCS-CPU-I8260Y	2.4	165	35.75	24/20/16	3 x 10.4	2933	2 nd Gen Intel® Xeon®
UCS-CPU-I8260L	2.4	165	35.75	24	3 x 10.4	2933	2 nd Gen Intel® Xeon®
UCS-CPU-I8260	2.4	165	35.75	24	3 x 10.4	2933	2 nd Gen Intel® Xeon®
UCS-CPU-I8253	2.2	125	22.00	16	3 x 10.4	2933	2 nd Gen Intel® Xeon®
6000 Series Processor							
UCS-CPU-I6262V	1.9	135	33.00	24	3 x 10.4	2400	2 nd Gen Intel® Xeon®
UCS-CPU-I6258R	2.7	205	38.50	28	2 x 10.4	2933	2 nd Gen Intel® Xeon®
UCS-CPU-I6256	3.6	205	33.00	12	3 x 10.4	2933	2 nd Gen Intel® Xeon®
UCS-CPU-I6254	3.1	200	24.75	18	3 x 10.4	2933	2 nd Gen Intel® Xeon®
UCS-CPU-I6252	2.1	150	35.75	24	3 x 10.4	2933	2 nd Gen Intel® Xeon®
UCS-CPU-I6248R	3.0	205	35.75	24	2 x 10.4	2933	2 nd Gen Intel® Xeon®
UCS-CPU-I6248	2.5	150	27.50	20	3 x 10.4	2933	2 nd Gen Intel® Xeon®
UCS-CPU-I6246R	3.4	205	35.75	16	2 x 10.4	2933	2 nd Gen Intel® Xeon®
UCS-CPU-I6246	3.3	165	24.75	12	3 x 10.4	2933	2 nd Gen Intel® Xeon®

Table 4 Available CPUs

Product ID (PID)	Clock Freq (GHz)	Power (W)	Cache Size (MB)	Cores	UPI ¹ Links (GT/s)	Highest DDR4 DIMM Clock Support (MHz) ²	Workload/Processor type
UCS-CPU-I6244	3.6	150	24.75	8	3 x 10.4	2933	2 nd Gen Intel® Xeon®
UCS-CPU-I6242R	3.1	205	35.75	20	2 x 10.4	2933	2 nd Gen Intel® Xeon®
UCS-CPU-I6242	2.8	150	22.00	16	3 x 10.4	2933	2 nd Gen Intel® Xeon®
UCS-CPU-I6240R	2.4	165	35.75	24	2 x 10.4	2933	2 nd Gen Intel® Xeon®
UCS-CPU-I6240Y	2.6	150	24.75	18/14/8	3 x 10.4	2933	2 nd Gen Intel® Xeon®
UCS-CPU-I6240L	2.6	150	24.75	18	3 x 10.4	2933	2 nd Gen Intel® Xeon®
UCS-CPU-I6240	2.6	150	24.75	18	3 x 10.4	2933	2 nd Gen Intel® Xeon®
UCS-CPU-I6238R	2.2	165	38.50	28	2 x 10.4	2933	2 nd Gen Intel® Xeon®
UCS-CPU-I6238L	2.1	140	30.25	22	3 x 10.4	2933	2 nd Gen Intel® Xeon®
UCS-CPU-I6238	2.1	140	30.25	22	3 x 10.4	2933	2 nd Gen Intel® Xeon®
UCS-CPU-I6234	3.3	130	24.75	8	3 x 10.4	2933	2 nd Gen Intel® Xeon®
UCS-CPU-I6230R	2.1	150	35.75	26	2 x 10.4	2933	2 nd Gen Intel® Xeon®
UCS-CPU-I6230N	2.3	125	27.50	20	3 x 10.4	2933	2 nd Gen Intel® Xeon®
UCS-CPU-I6230	2.1	125	27.50	20	3 x 10.4	2933	2 nd Gen Intel® Xeon®
UCS-CPU-I6226R	2.9	150	22.00	16	2 x 10.4	2933	2 nd Gen Intel® Xeon®
UCS-CPU-I6226	2.7	125	19.25	12	3 x 10.4	2933	2 nd Gen Intel® Xeon®
UCS-CPU-I6222V	1.8	115	27.50	20	3 x 10.4	2400	2 nd Gen Intel® Xeon®
5000 Series Processor							
UCS-CPU-I5222	3.8	105	16.50	4	2 x 10.4	2933	2 nd Gen Intel® Xeon®
UCS-CPU-I5220S	2.6	125	19.25	18	2 x 10.4	2666	2 nd Gen Intel® Xeon®
UCS-CPU-I5220R	2.2	150	35.75	24	2 x 10.4	2666	2 nd Gen Intel® Xeon®
UCS-CPU-I5220	2.2	125	24.75	18	2 x 10.4	2666	2 nd Gen Intel® Xeon®
UCS-CPU-I5218R	2.1	125	27.50	20	2 x 10.4	2666	2 nd Gen Intel® Xeon®
UCS-CPU-I5218B	2.3	125	22.00	16	2 x 10.4	2933	2 nd Gen Intel® Xeon®
UCS-CPU-I5218N	2.3	105	22.00	16	2 x 10.4	2666	2 nd Gen Intel® Xeon®
UCS-CPU-I5218	2.3	125	22.00	16	2 x 10.4	2666	2 nd Gen Intel® Xeon®
UCS-CPU-I5217	3.0	115	11.00	8	2 x 10.4	2666	2 nd Gen Intel® Xeon®
UCS-CPU-I5215L	2.5	85	13.75	10	2 x 10.4	2666	2 nd Gen Intel® Xeon®
UCS-CPU-I5215	2.5	85	13.75	10	2 x 10.4	2666	2 nd Gen Intel® Xeon®
4000 Series Processor							
UCS-CPU-I4216	2.1	100	22.00	16	2 x 9.6	2400	2 nd Gen Intel® Xeon®
UCS-CPU-I4215R	3.2	130	11.00	8	2 x 9.6	2400	2 nd Gen Intel® Xeon®
UCS-CPU-I4215	2.5	85	11.00	8	2 x 9.6	2400	2 nd Gen Intel® Xeon®

Table 4 Available CPUs

Product ID (PID)	Clock Freq (GHz)	Power (W)	Cache Size (MB)	Cores	UPI ¹ Links (GT/s)	Highest DDR4 DIMM Clock Support (MHz) ²	Workload/Processor type
UCS-CPU-I4214R	2.4	100	16.50	12	2 x 9.6	2400	2 nd Gen Intel® Xeon®
UCS-CPU-I4214	2.2	85	16.50	12	2 x 9.6	2400	2 nd Gen Intel® Xeon®
UCS-CPU-I4210R	2.4	100	13.75	10	2 x 9.6	2400	2 nd Gen Intel® Xeon®
UCS-CPU-I4210	2.2	85	13.75	10	2 x 9.6	2400	2 nd Gen Intel® Xeon®
UCS-CPU-I4208	2.1	85	11.00	8	2 x 9.6	2400	2 nd Gen Intel® Xeon®
3000 Series Processor							
UCS-CPU-I3206R	1.9	85	11.00	8	2 x 9.6	2133	2 nd Gen Intel® Xeon®

Notes:

1. UPI = Ultra Path Interconnect. 2-socket servers support only 2 UPI performance, even if the CPU supports 3 UPI.
2. If higher or lower speed DIMMs are selected than what is shown in [Table 4 on page 15](#) for a given CPU speed, the DIMMs will be clocked at the lowest common denominator of CPU clock and DIMM clock.

The following table lists ambient temperature limitation and displayed respective temperature (last column) and configuration restrictions to ensure proper cooling and avoid excessive processor throttling, which may impact system performance.

Table 4a Ambient Temperature and Configuration Restrictions

Processor Thermal Design Power (TDP)	CPU PID/Description	Ambient Temperature Limitation
205W	UCS-CPU-I6256 - 3.6GHz/205W 12C/33MB PMM DDR4 1TB 2933 MHz	30°C [86°F]
205W R SKUs	UCS-CPU-I6258R - 2.7GHz/205W 28C/38.50MB DDR4 2933 MHz UCS-CPU-I6248R - 3.0GHz/205W 24C/35.75MB DDR4 2933 MHz UCS-CPU-I6246R - 3.4GHz/205W 16C/35.75MB DDR4 2933 MHz UCS-CPU-I6242R - 3.1GHz/205W 20C/35.75MB DDR4 2933 MHz	32°C [90°F]
 CAUTION:	Systems configured with above processors need to adhere by the below ambient inlet temperature threshold, if not, a fan fault or executing workloads with extensive use of heavy instructions sets like Intel® Advanced Vector Extensions 512 (Intel® AVX-512), may assert thermal and/or performance faults with an associated event recorded in the System Event Log (SEL).	

Supported Configurations

(1) DIMM only configurations:

- Select one or two identical CPUs listed in [Table 4 on page 15](#)

(2) DIMM/PMem Mixed Configurations:

- You must select two identical CPUs listed in [Table 4 on page 15](#)

Caveats

- The selection of 1 or 2 CPUs depends on the desired server functionality. See the following sections:
 - [STEP 4 SELECT MEMORY, page 21](#)
 - [STEP 5 SELECT RAID CONTROLLERS, page 28](#)
 - [STEP 6 SELECT DRIVES, page 33](#)
 - [STEP 7 SELECT PCIe OPTION CARD\(s\), page 42](#)



NOTE: Due to EU Regulation 2019/424, you can select only min qty to two (2) for below CPUs

UCS-CPU-I4210, UCS-CPU-I4215



NOTE: See [SELECT MEMORY, page 21](#) for details on the compatibility of CPUs and DIMM speeds.

STEP 4 SELECT MEMORY

The available memory for the C240 M5 SFF is as follows:

- Clock speed: Up to 2933 MHz; See available CPUs and their associated DDR4 DIMM maximum clock support in [Table 4](#).
- Rank per DIMM: 1, 2, 4, or 8
- Operational voltage: 1.2 V
- Registered ECC DDR4 DIMMs (RDIMMs), Load-reduced DIMMs (LRDIMMs), or Intel® Optane™ Persistent Memory Modules (PMem)

Memory is organized with six memory channels per CPU, with up to two DIMMs per channel, as shown in [Figure 5](#).

Figure 5 C240 M5 SFF Memory Organization

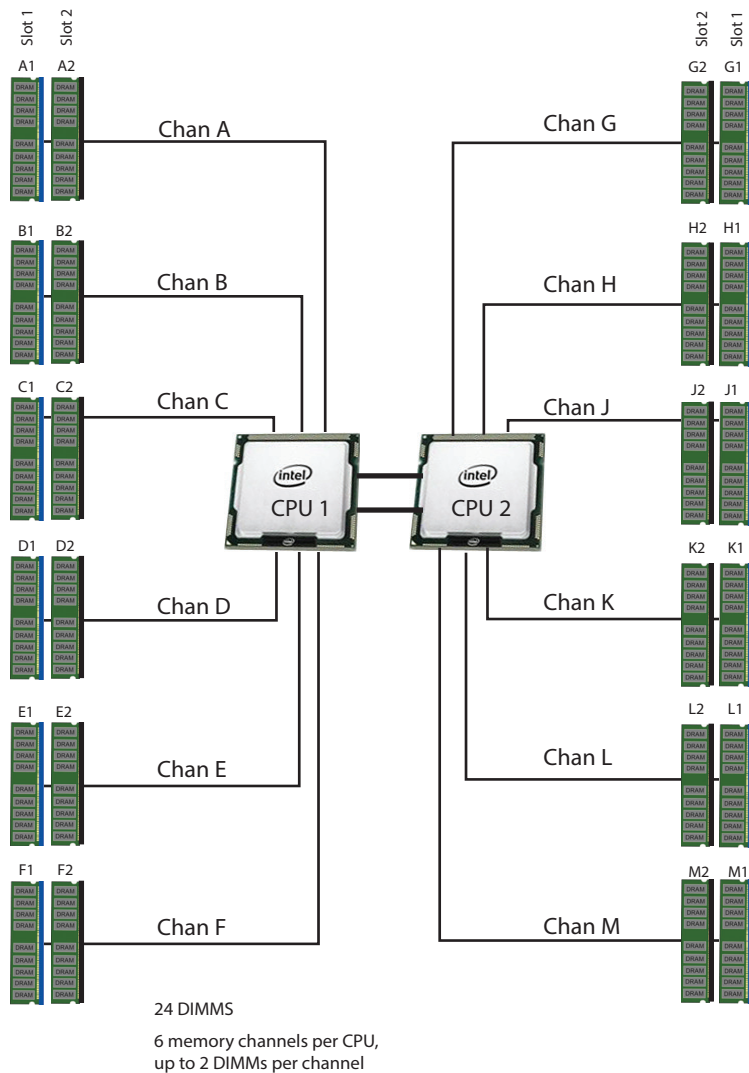

Select DIMMs and Memory Mirroring

Select the memory configuration and whether or not you want the memory mirroring option. The available memory DIMMs and mirroring option are listed in [Table 5](#).



NOTE: When memory mirroring is enabled, the memory subsystem simultaneously writes identical data to two channels. If a memory read from one of the channels returns incorrect data due to an uncorrectable memory error, the system automatically retrieves the data from the other channel. A transient or soft error in one channel does not affect the mirrored data, and operation continues unless there is a simultaneous error in exactly the same location on a DIMM and its mirrored DIMM. Memory mirroring reduces the amount of memory available to the operating system by 50% because only one of the two populated channels provides data.

Table 5 Available DDR4 DIMMs

Product ID (PID)	PID Description	Voltage	Ranks /DIMM
UCS-ML-256G8RW ¹	256 GB DDR4-3200MHz LRDIMM 8Rx4 (16Gb) (3DS)	1.2 V	8
UCS-ML-128G4RW ¹	128 GB DDR4-3200MHz LRDIMM 4Rx4 (16Gb) (non-3DS)	1.2 V	4
UCS-MR-X64G2RW ¹	64 GB DDR4-3200MHz RDIMM 2Rx4 (16Gb)	1.2 V	2
UCS-MR-X32G2RW ¹	32 GB DDR4-3200MHz RDIMM 2Rx4 (8Gb)	1.2 V	2
UCS-MR-X16G1RW ¹	16 GB DDR4-3200MHz RDIMM 1Rx4 (8Gb)	1.2 V	1
Intel® Optane™ Persistent Memory Product			
UCS-MP-128GS-A0	Intel® Optane™ Persistent Memory, 128GB, 2666 MHz		
UCS-MP-256GS-A0	Intel® Optane™ Persistent Memory, 256GB, 2666 MHz		
UCS-MP-512GS-A0	Intel® Optane™ Persistent Memory, 512GB, 2666 MHz		
Intel® Optane™ Persistent Memory Product Operational Modes			
UCS-DCPMM-AD	App Direct Mode		
UCS-DCPMM-MM	Memory Mode		
Memory Mirroring Option			
N01-MMIRROR	Memory mirroring option		

Notes:

1. DDR4-3200MHz replacement part numbers will operate at the maximum speed of the Intel 2nd generation Xeon Scalable processor memory interface, ranging from 2133 MHz to 2933 MHz.

Approved Configurations

(1) 1-CPU configuration without memory mirroring:

- Select from 1 to 12 DIMMs.

CPU 1 DIMM Placement in Channels (for identically ranked DIMMs)	
1	(A1)
2	(A1, B1)
3	(A1, B1, C1)
4	(A1, B1); (D1, E1)
6	(A1, B1); (C1, D1); (E1, F1)
8	(A1, B1); (D1, E1); (A2, B2); (D2, E2)
12	(A1, B1); (C1, D1); (E1, F1); (A2, B2); (C2, D2); (E2, F2)

(2) 1-CPU configuration with memory mirroring:

- Select 4, 6, 8, or 12 identical DIMMs. The DIMMs will be placed by the factory as shown in the following table.

CPU 1 DIMM Placement in Channels (for identical ranked DIMMs)	
4	(A1, B1); (D1, E1)
6	(A1, B1, C1); (D1, E1, F1)
8	(A1, A2, B1, B2); (D1, D2, E1, E2)
12	(A1, A2, B1, B2, C1, C2); (D1, D2, E1, E2, F1, F2)

- Select the memory mirroring option (N01-MMIRROR) as shown in [Table 5 on page 22](#).

(3) 2-CPU configuration without memory mirroring:

- Select from 1 to 12 DIMMs per CPU.

CPU 1 DIMM Placement in Channels (for identical ranked DIMMs)		CPU 2 DIMM Placement in Channels (for identical ranked DIMMs)
CPU 1		CPU 2
1	(A1)	(G1)
2	(A1, B1)	(G1, H1)
3	(A1, B1, C1)	(G1, H1, J1)
4	(A1, B1); (D1, E1)	(G1, H1); (K1, L1)
6	(A1, B1); (C1, D1); (E1, F1)	(G1, H1); (J1, K1); (L1, M1)
8	(A1, B1); (D1, E1); (A2, B2); (D2, E2)	(G1, H1); (K1, L1); (G2, H2); (K2, L2)
12	(A1, B1); (C1, D1); (E1, F1); (A2, B2); (C2, D2); (E2, F2)	(G1, H1); (J1, K1); (L1, M1); (G2, H2); (J2, K2); (L2, M2)

(4) 2-CPU configuration with memory mirroring:

- Select 8,12 16, or 24 identical DIMMs per CPU. The DIMMs will be placed by the factory as shown in the following table.

CPU 1 DIMM Placement in Channels (for identical ranked DIMMs)		CPU 2 DIMM Placement in Channels (for identical ranked DIMMs)
CPU 1		CPU 2
8	(A1,B1); (D1,E1)	(G1, H1); (K1, L1)
12	(A1, B1, C1); (D1, E1, F1)	(G1, H1, J1); (K1, L1, M1)
16	(A1, A2, B1, B2); (D1, D2, E1, E2)	(G1, G2, H1, H2); (K1, K2, L1, L2)
24	(A1, A2, B1, B2, C1, C2); (D1, D2, E1, E2, F1, F2)	(G1, G2, H1, H2, J1, J2); (K1, K2, L1, L2, M1, M2)

- Select the memory mirroring option (N01-MMIRROR) as shown in [Table 5 on page 22](#).



NOTE:

- System performance is optimized when the DIMM type and quantity are equal for both CPUs, and when all channels are filled equally across the CPUs in the server.
- DIMM mixing is not allowed when PMem are installed; in these cases, all DIMMs must be the same type and size.

System Speed

Memory will operate at the maximum speed of the Intel Xeon Scalable processor memory controller, ranging from 2133 MHz to 2933 MHz for M5 servers. Check CPU specifications for supported speeds



NOTE: Detailed mixing DIMM configurations are described in Cisco UCS [Cisco UCS C220/C240/B200 M5 Memory Guide](#)

See [Table 6](#) for PMem memory modes.

Table 6 Intel® Optane™ Persistent Memory Modes

Intel® Optane™ Persistent Memory	
App Direct Mode:	PMem operates as a solid-state disk storage device. Data is saved and is non-volatile. Both PMem and DIMM capacity counts towards CPU tiering (both PMem and DIMM capacities count towards the CPU capacity limit)
Memory Mode: ¹	PMem operates as a 100% memory module. Data is volatile and DRAM acts as a cache for PMem. Only PMem capacity counts towards CPU tiering (only the PMem capacity counts towards the CPU capacity limit). This is the factory default mode.
Mix Mode:	DRAM as cache. Only PMem capacity counts towards CPU tiering (only the PMem capacity counts towards the CPU capacity limit)

Notes:

1. For Memory Mode, the Intel-recommended DIMM to PMem capacity ratio in the same CPU channel is from 1:2 to 1:16. So if you use a 128 GB DIMM in a channel, you could use a 512 GB PMem for a 1:4 capacity ratio. If you use a 32 GB DIMM in a channel, you could use a 512 GB PMem for a 1:16 capacity ratio. There are several other combinations possible.

Table 7 2nd Generation Intel® Xeon® Scalable Processor DIMM and PMem¹ Physical Configuration

DIMM to PMem Count	CPU 1											
	iMC1						iMCO					
	Channel 2		Channel 1		Channel 0		Channel 2		Channel 1		Channel 0	
	F2	F1	E2	E1	D2	D1	C2	C1	B2	B1	A2	A1
6 - 2		DIMM		DIMM	PMem	DIMM		DIMM		DIMM	PMem	DIMM
6 - 4		DIMM	PMem	DIMM	PMem	DIMM		DIMM	PMem	DIMM	PMem	DIMM
6 - 6	PMem	DIMM	PMem	DIMM	PMem	DIMM	PMem	DIMM	PMem	DIMM	PMem	DIMM
DIMM to PMem Count	CPU 2											
	iMC1						iMCO					
	Channel 2		Channel 1		Channel 0		Channel 2		Channel 1		Channel 0	
	M2	M1	L2	L1	K2	K1	J2	J1	H2	H1	G2	G1
6 - 2		DIMM		DIMM	PMem	DIMM		DIMM		DIMM	PMem	DIMM
6 - 4		DIMM	PMem	DIMM	PMem	DIMM		DIMM	PMem	DIMM	PMem	DIMM
6 - 6	PMem	DIMM	PMem	DIMM	PMem	DIMM	PMem	DIMM	PMem	DIMM	PMem	DIMM

Notes:

1. All systems must be fully populated with CPUs when using PMem at this time.



NOTE: There are three possible memory configurations for each CPU when combining DIMMs and PMem, and the configurations must be the same for each CPU:

- 6 DIMMs and 2 PMem, or
 - 6 DIMMs and 4 PMem, or
 - 6 DIMMs and 6 PMem
-

For detailed Intel PMem configurations, refer to

[Cisco UCS C240 M5 Server Installation and Service Guide](#)

For detailed DIMM/PMem informations, refer to

[Cisco UCS C220/C240/B200 M5 Memory Guide](#)

STEP 5 SELECT RAID CONTROLLERS

RAID Controller Options (internal HDD/SSD support)



NOTE: NVMe drives are controlled directly by CPU2 and not by any RAID controller.

Embedded Software RAID

The default RAID configuration is embedded software RAID, which supports only SATA-only HDDs and enterprise value SATA-only SSDs (RAID 0, 1, 10). A maximum of 8 SATA drives are supported with embedded software RAID. Embedded RAID requires a SATA interposer board.



NOTE: Embedded software RAID is limited to Windows and Linux operating systems only. There is no VMWare support for embedded software RAID.

Cisco 12G SAS RAID Controller

You can choose a Cisco 12G SAS RAID controller, which plugs into a dedicated RAID controller card slot. This RAID controller supports RAID 0, 1, 5, 6, 10, 50, 60, and JBOD mode.



NOTE: The number of RAID groups (virtual drives) supported per RAID controller is as follows:

- Embedded RAID = 8
 - Cisco 12G SAS RAID controller = 64
-

Cisco 12G SAS HBA (internal HDD/SSD/JBOD support)

You can choose a SAS HBA for JBOD or Pass-through mode support:

- The Cisco 12G SAS HBA plugs into a dedicated RAID controller slot.

SAS HBA (external JBOD support)

In addition to a RAID controller or JBOD controller for internal drives, you can choose up to two of the following SAS HBAs for external JBOD drive connectivity (non-RAID):

- Cisco 9400-8e 12G SAS HBA for external JBOD attach (choose up to two).

RAID Volumes and Groups

When creating each RAID volume, follow these guidelines:

- Use the same capacity for each drive in each RAID volume
- For embedded software RAID:

- Use only SATA HDDs or SATA SSDs but do not mix HDDs and SSDs
 - Embedded software RAID has two ports and each port can control 4 drives, for 8 drives total.
 - Each set of 4 SATA HDDs or SATA SSDs for a port must be in separate RAID volumes.
 - You cannot mix drives across ports to create a RAID volume.
- For the Cisco 12G SAS RAID controller upgrade:
 - Use either all SAS/SATA HDDs, or all SAS SSDs, or all SATA SSDs in each RAID volume

Select Controller Options

Select as follows:

- For a 26-drive server version, select one of the following:
 - Cisco 12G SAS RAID controller with 4 GB cache from [Table 8 on page 30](#), or
 - Cisco 12G SAS HBA from [Table 8 on page 30](#), or
- For an 8-drive backplane system, select one of the following:
 - Embedded software RAID (this is the default if no other selection is made), or
 - Cisco 12G SAS RAID controller from [Table 8 on page 30](#), or
 - Cisco 12G SAS HBA (see [Table 8 on page 30](#))



NOTE: The UCSC-C240-M5SN does not support embedded RAID.



NOTE: The default RAID solution is embedded software RAID that supports a limited number of drives, operating systems, and virtualized environments. For a more comprehensive RAID solution, choose a controller from [Table 8](#).

Table 8 Hardware Controller Options

Product ID (PID)	PID Description
Controllers for Internal Drives	
Note that if the following Cisco 12G SAS RAID controller or Cisco 12G SAS HBA controller is selected, it is factory-installed in the dedicated internal slot.	
UCSC-RAID-M5HD	<p>Cisco 12G SAS RAID Controller with 4 GB FBWC</p> <ul style="list-style-type: none"> ■ Supports up to 26 internal SAS/SATA HDDs and SAS/SATA SSDs ■ Supports RAID 0, 1, 5, 6, 10, 50, 60, and JBOD mode. Supports running mixed RAID and JBOD mode. ■ For all self-encrypting drives (SED), standalone Management (CIMC/UCSM) is supported for configuring and managing local keys. For now, SED drives are managed with local key management only. Third-party key management will be supported (KMIP compliant).
UCSC-SAS-M5HD	<p>Cisco 12G SAS HBA for up to 26 drives</p> <ul style="list-style-type: none"> ■ Supports up to 26 internal SAS/SATAHDDs and SAS/SATA SSDs ■ Supports JBOD mode only (no RAID functionality). Ideal for SDS (Software Defined Storage) applications. It is also ideal for environments demanding the highest IOPs (for external SSD attach), where a RAID controller can be an I/O bottleneck. ■ No SED drive support.
Controllers for External Drives	
UCSC-9400-8E	Cisco 12G 9400-8e 12G SAS HBA for external JBOD attach (select up to two)
RAID Configuration Options (not available for Cisco 12G SAS HBA or embedded software RAID)	
R2XX-SRAID0	Enable Single Disk Raid 0 Setting
R2XX-RAID0	Factory preconfigured RAID striping option Enable RAID 0 Setting. Requires a minimum of one hard drive.
R2XX-RAID1	Factory preconfigured RAID mirroring option Enable RAID 1 Setting. Requires exactly two drives with the same size, speed, capacity.
R2XX-RAID5	Factory preconfigured RAID option Enable RAID 5 Setting. Requires a minimum of three drives of the same size, speed, capacity.
R2XX-RAID6	Factory preconfigured RAID option Enable RAID 6 Setting. Requires a minimum of four drives of the same size, speed, capacity.
R2XX-RAID10	Factory preconfigured RAID option Enable RAID 10 Setting. Requires a minimum of four drives of the same size, speed, capacity.

**NOTE:**

- Although RAID levels 50 and 60 are not orderable from the factory, they are supported for selected controllers as shown in [Table 8](#)
- For Cisco SAS 9400-8e 12G SAS HBA external drive enclosure support, see the enclosure section of the compatibility list at the following link:
<https://www.broadcom.com/support/storage/interop-compatibility/>
Customers should contact their storage vendor for technical support related to external JBOD enclosures.

Approved Configurations

The C240 M5 SFF server can be ordered as a UCSC-C240-M5SX or UCSC-C240-M5SN (26-drive backplane) or a UCSC-C240-M5S (8-drive backplane).

- The embedded software RAID supports up to 8 internal SATA HDDs with RAID 0, 1, 10 support.
- The embedded software RAID does not support rear SAS/SATA drives, front and rear NVMe are supported.
- There is no RAID support for NVMe drives.
- In an embedded RAID configuration, only embedded software RAID (0, 1, 10) is supported, AHCI mode is not supported.
- The Cisco 12G SAS RAID controller upgrade option supports up to 26 internal drives with up to RAID 0, 1, 10, 5, 6, 50, 60, JBOD mode.
- The Cisco 12 Gbps SAS HBA supports up to 26 internal drives with JBOD support.
- Up to two Cisco 12G 9400-8e SAS HBA external drive PCIe controller cards can be installed simultaneously with the Cisco 12G SAS Modular RAID controller card (UCSC-RAID-M5) or Cisco 12 Gbps Modular SAS HBA (UCSC-SAS-M5).

See [Table 9](#) for a summary of the supported controller configuration options

Table 9 Supported Controller Configurations

Server Model	# of CPUs	Embedded RAID	Cisco 12G SAS RAID Controller or Cisco 12G SAS HBA (only one can be installed at a time)		Cisco 12G 9400-8e 12G SAS HBA	MAX# Drives Supported	RAID Support	Internal Drive Types Allowed
			RAID	SAS HBA				
			UCSC-RAID-M5 HD and UCSC-RAID-M5	UCSC-SAS-M5 HD and UCSC-SAS-M5				
C240 M5 SFF 8 Front Drives	1	Enabled	Not allowed	Not allowed	Up to two installed in rear PCIe slots	8 internal SATA only	0, 1, 10 (SATA only)	SATA HDDs/Enterprise Value SSDs
C240 M5 SFF 8 Front Drives	1	Not allowed	Installed in a dedicated slot	Installed in a dedicated slot	Up to two installed in rear PCIe slots	10 internal, 8 or 16 external	0,1,10,5,6,50, 60 JBOD (12G SAS RAID), JBOD (SAS HBA)	SAS/SATA HDDs, SAS/SATA SSDs (NVMe requires 2 CPUs)
			Only one of the above can be installed at a time					
C240 M5 SFF 24 Front Drives	1	Not allowed	Installed in a dedicated slot	Installed in a dedicated slot	Up to two installed in rear PCIe slots	26 internal, 8 or 16 external	0,1,10,5,6,50, 60 JBOD (12G SAS RAID), JBOD (SAS HBA)	SAS/SATA HDDs, SAS/SATA SSDs (NVMe requires 2 CPUs)
			Only one of the above can be installed at a time					
C240 M5 SFF 8 Front Drives	2	Enabled	Not allowed	Not allowed	Up to two installed in rear PCIe slots	8 internal SATA only, 8 or 16 external	0, 1, 10 (SATA only)	SATA HDDs/Enterprise Value SSDs
C240 M5 SFF 8 Front Drives	2	Not allowed	Installed in a dedicated slot	Installed in a dedicated slot	Up to two installed in rear PCIe slots	10 internal, 8 or 16 external	0,1,10,5,6,50, 60 JBOD (12G SAS RAID), JBOD (SAS HBA)	SAS/SATA HDDs, SAS/SATA SSDs, SFF NVMe
			Only one of the above can be installed at a time					
C240 M5 SFF 24 Front Drives	2	Not allowed	Installed in a dedicated slot	Installed in a dedicated slot	Up to two installed in rear PCIe slots	26 internal, 8 or 16 external	0,1,10,5,6,50, 60 JBOD (12G SAS RAID), JBOD (SAS HBA)	SAS/SATA HDDs, SAS/SATA SSDs, SFF NVMe
			Only one of the above can be installed at a time					



NOTE: UCS C240 M5 servers with embedded software RAID do not support rear SAS/SATA drives; however, front and rear SFF NVMe drives are supported. There is no RAID support for NVMe. In an embedded RAID configuration, only embedded software RAID (0, 1, 10) is supported, and AHCI mode is not supported.

STEP 6 SELECT DRIVES

The standard disk drive features are:

- 2.5-inch small form factor
- Hot-pluggable
- Drives come mounted in sleds

Select Front-Facing Drives

The available drives are listed in [Table 10](#).

Table 10 Available Hot-Pluggable Sled-Mounted Front Facing Drives (UCSC-C240-M5SX (24-drive system), UCSC-C240-M5S (8-drive system), UCSC-C240-M5SN (24-drive system with SFF NVMe-only for rear-facing drives))

Product ID (PID)	PID Description	Drive Type	Capacity
HDDs			
HDDs (15K RPM)			
UCS-HD300G15K12N	300 GB 12G SAS 15K RPM SFF HDD	SAS	300 GB
UCS-HD600G15K12N	600 GB 12G SAS 15K RPM SFF HDD	SAS	600 GB
UCS-HD900G15K12N	900 GB 12G SAS 15K RPM SFF HDD	SAS	900 GB
HDDs (10K RPM)			
UCS-HD300G10K12N	300 GB 12G SAS 10K RPM SFF HDD	SAS	300 GB
UCS-HD600G10K12N	600 GB 12G SAS 10K RPM SFF HDD	SAS	600 GB
UCS-HD12TB10K12N	1.2 TB 12G SAS 10K RPM SFF HDD	SAS	1.2 TB
UCS-HD18TB10K4KN ¹	1.8 TB 12G SAS 10K RPM SFF HDD (4K)	SAS	1.8 TB
UCS-HD24TB10K4KN	2.4 TB 12G SAS 10K RPM SFF HDD (4K)	SAS	2.4 TB
HDDs (7.2K RPM)			
UCS-HD1T7K12N	1 TB 12G SAS 7.2K RPM SFF HDD	SAS	1 TB
UCS-HD2T7K12N	2 TB 12G SAS 7.2K RPM SFF HDD	SAS	2 TB
UCS-HD1T7K6GAN	1 TB 6G SATA 7.2K RPM SFF HDD	SAS	1 TB
SAS/SATA SSDs			
Enterprise Performance SSDs (High endurance, supports up to 10X or 3X DWPD (drive writes per day))²			
SAS SSDs			
UCS-SD800GK3X-EP	800 GB 2.5in Enterprise Performance 12G SAS SSD(3X endurance)	SAS	800 GB
UCS-SD16TK3X-EP	1.6 TB 2.5in Enterprise Performance 12G SAS SSD(3X endurance)	SAS	1.6 TB
UCS-SD32TK3X-EP	3.2 TB 2.5in Enterprise Performance 12G SAS SSD(3X endurance)	SAS	3.2 TB
UCS-SD32TKA3X-EP	3.2TB 2.5in Enter Perf 12G SAS Kioxia G2 SSD (3X)	SAS	3.2 TB
SATA SSDs			

Table 10 Available Hot-Pluggable Sled-Mounted Front Facing Drives (continued)
 (UCSC-C240-M5SX (24-drive system), UCSC-C240-M5S (8-drive system), UCSC-C240-M5SN
 (24-drive system with SFF NVMe-only for rear-facing drives))

Product ID (PID)	PID Description	Drive Type	Capacity
UCS-SD480G63X-EP	480GB 2.5in Enterprise performance 6GSATA SSD (3X endurance) (Intel S4600/S4610)	SATA	480 GB
UCS-SD960G63X-EP	960GB 2.5in Enterprise performance 6GSATA SSD (3X endurance) (Intel S4600/S4610)	SATA	960 GB
UCS-SD19T63X-EP	1.9TB 2.5in Enterprise performance 6GSATA SSD (3X endurance) (Intel S4600/S4610)	SATA	1.9 TB
UCS-SD19TBM3X-EP	1.9TB 2.5in Enterprise performance 6GSATA SSD(3X endurance)	SATA	1.9 TB
UCS-SD960GBM3X-EP	960GB 2.5in Enterprise performance 6GSATA SSD(3X endurance)	SATA	960 GB
UCS-SD480GBM3X-EP	480GB 2.5in Enterprise Performance 6GSATA SSD(3X endurance)	SATA	480 GB
Enterprise Value SSDs (Low endurance, supports up to 1X DDPD (drive writes per day))³			
SAS SSDs			
UCS-SD960GK1X-EV	960 GB 2.5 inch Enterprise Value 12G SAS SSD	SAS	960 GB
UCS-SD19TK1X-EV	1.9 TB 2.5 inch Enterprise Value 12G SAS SSD	SAS	1.9 TB
UCS-SD38TK1X-EV	3.8 TB 2.5 inch Enterprise Value 12G SAS SSD	SAS	3.8 TB
UCS-SD76TK1X-EV	7.6 TB 2.5 inch Enterprise Value 12G SAS SSD	SAS	7.6 TB
UCS-SD15TK1X-EV	15.3 TB 2.5 inch Enterprise Value 12G SAS SSD	SAS	15.3 TB
SATA SSDs			
UCS-SD76TBM1X-EV	7.6TB 2.5 inch Enterprise Value 6G SATA SSD	SATA	7.6 TB
UCS-SD38TBM1X-EV	3.8TB 2.5 inch Enterprise Value 6G SATA SSD	SATA	3.8 TB
UCS-SD19TBM1X-EV	1.9TB 2.5 inch Enterprise Value 6G SATA SSD	SATA	1.9 TB
UCS-SD16TBM1X-EV	1.6TB 2.5 inch Enterprise Value 6G SATA SSD	SATA	1.6 TB
UCS-SD960GBM1X-EV	960GB 2.5 inch Enterprise Value 6G SATA SSD	SATA	960 GB
UCS-SD480GBM1X-EV	480 GB 2.5 inch Enterprise Value 6G SATA SSD	SATA	480 GB
UCS-SD240GBM1X-EV	240GB 2.5 inch Enterprise Value 6G SATA SSD	SATA	240 GB
UCS-SD120GM1X-EV	120 GB 2.5 inch Enterprise Value 6G SATA SSD (Micron 5100/5200/5300)	SATA	120 GB
UCS-SD19T61X-EV	1.9 TB 2.5 inch Enterprise Value 6G SATA SSD (Samsung PM863A/PM883)	SATA	1.9 TB
UCS-SD38T61X-EV	3.8TB 2.5 inch Enterprise Value 6G SATA SSD (Samsung PM863A/PM883)	SATA	3.8 TB
UCS-SD480G611X-EV	480 GB 2.5 inch Enterprise Value 6G SATA SSD (Intel S4500/S4510)	SATA	480 GB
UCS-SD960G611X-EV	960 GB 2.5 inch Enterprise Value 6G SATA SSD (Intel S4500/S4510)	SATA	960 GB
UCS-SD38T611X-EV	3.8 TB 2.5 inch Enterprise Value 6G SATA SSD (Intel S4500/S4510)	SATA	3.8 TB
UCS-SD960G6S1X-EV	960GB 2.5 inch Enterprise Value 6G SATA SSD	SATA	960 GB
UCS-SD19T6S1X-EV	1.9TB 2.5 inch Enterprise Value 6G SATA SSD	SATA	1.9 TB
UCS-SD38T6S1X-EV	3.8TB 2.5 inch Enterprise Value 6G SATA SSD	SATA	3.8 TB
UCS-SD76T6S1X-EV	7.6TB 2.5 inch Enterprise Value 6G SATA SSD	SATA	7.6 TB
Self-Encrypted Drives (SED)⁴			

Table 10 Available Hot-Pluggable Sled-Mounted Front Facing Drives (continued)
 (UCSC-C240-M5SX (24-drive system), UCSC-C240-M5S (8-drive system), UCSC-C240-M5SN
 (24-drive system with SFF NVMe-only for rear-facing drives))

Product ID (PID)	PID Description	Drive Type	Capacity
SAS			
UCS-HD600G15NK9	600 GB 12G SAS 15K RPM SFF HDD (SED) FIPS140-2	SAS	600 GB
UCS-HD24T10NK9	2.4 TB 12G SAS 10K RPM SFF HDD (4K) (SED) FIPS140-2	SAS	2.4 TB
UCS-HD18T10NK9	1.8 TB 12G SAS 10K RPM SFF HDD (4K format, SED) FIPS140-2	SAS	1.8 TB
UCS-HD12T10NK9	1.2 TB 12G SAS 10K RPM SFF HDD (SED) FIPS140-2	SAS	1.2 TB
UCS-SD800GBKNK9	800GB Enterprise Performance SAS SSD (3X DWPD, SED) FIPS140-2	SAS	800 GB
UCS-SD960GBKNK9	960GB Enterprise Value SAS SSD (1X DWPD, SED) FIPS140-2	SAS	960 GB
UCS-SD38TBKNK9	3.8TB Enterprise Value SAS SSD (1X DWPD, SED) FIPS140-2	SAS	3.8 TB
UCS-SD16TBKNK9	1.6TB Enterprise performance SAS SSD (3X DWPD, SED) FIPS140-2	SAS	1.6 TB
UCS-SD76TBKNK9	7.6TB Enterprise value SAS SSD (1 DWPD, SED-FIPS) FIPS140-2	SAS	7.6 TB
PCIe/NVMe SFF 2.5" drives^{5,6}			
UCSC-NVMEHW-H7680	Cisco 2.5" U.2 7.7 TB HGST SN200 NVMe High Perf. Value Endurance	NVMe	7.7 TB
UCSC-NVMEXPB-I375	375 GB 2.5in Intel Optane NVMe Extreme Performance SSD	NVMe	375 GB
UCSC-NVMEXP-I750	750 GB 2.5in Intel Optane NVMe Extreme Performance	NVMe	750 GB
UCS-NVME4-1920	1.9TB 2.5in U.2 15mm P5520 Hg Perf Med End NVMe	NVMe	1,9 TB
UCS-NVME4-3840	3.8TB 2.5in U.2 15mm P5520 Hg Perf Med End NVMe	NVMe	3.8 TB
UCS-NVME4-7680	7.6TB 2.5in U.2 15mm P5520 Hg Perf Med End NVMe	NVMe	7.6 TB
UCS-NVME4-1536	15.3TB 2.5in U.2 15mm P5520 Hg Perf Med End NVMe	NVMe	15.3 TB
UCS-NVME4-1600	1.6TB 2.5in U.2 15mm P5620 Hg Perf Hg End NVMe (3X)	NVMe	1.6 TB
UCS-NVME4-3200	3.2TB 2.5in U.2 15mm P5620 Hg Perf Hg End NVMe (3X)	NVMe	3.2 TB
UCS-NVME4-6400	6.4TB 2.5in U.2 15mm P5620 Hg Perf Hg End NVMe (3X)	NVMe	6.4 TB
UCS-NVMEQ-1536	15.3TB 2.5in U.2 15mm P5316 Hg Perf Low End NVMe	NVMe	15.3 TB
UCS-NVMEXP-I400	400GB 2.5in U.2 Intel P5800X Optane NVMe Extreme Perform SSD	NVMe	400 GB
UCS-NVMEXP-I800	800GB 2.5in U.2 Intel P5800X Optane NVMe Extreme Perform SSD	NVMe	800 GB
UCS-NVMEM6-W3200	3.2TB 2.5in U.2 WD SN840 NVMe Extreme Perf. High Endurance	NVMe	3.2 TB
UCS-NVMEM6-W7680	7.6TB 2.5in U.2 WD SN840 NVMe Extreme Perf. Value Endurance	NVMe	7.6 TB
UCS-NVMEM6-W15300	15.3TB 2.5in U.2 WD SN840 NVMe Extreme Perf. Value Endurance	NVMe	15.3 TB
NOTE: Cisco uses solid state drives from a number of vendors. All solid state drives are subject to physical write limits and have varying maximum usage limitation specifications set by the manufacturer. Cisco will not replace any solid state drives that have exceeded any maximum usage specifications set by Cisco or the manufacturer, as determined solely by Cisco.			

Notes:

1. Operating Systems supported on 4k sector size drives are as follows:
 - Windows: Minimum release Win2012 and later
 - Linux: Minimum release RHEL 6.5 and later
 - VMware ESXI 6.5 and later is needed for 512E drive support; VMware ESXI 6.7 and later is needed for 4KN drive support.
 - UEFI Mode must be used when booting from 4K sector size drives, legacy mode is not supported.
 - Ensure that 4K sector size and 512 byte sector size drives are not mixed in the same RAID volume.
2. Targeted for write centric IO applications. Supports endurance of 10 or 3 DWPD (drive writes per day). Target applications are caching, online transaction processing (OLTP), data warehousing, and virtual desktop infrastructure (VDI).
3. Targeted for read centric IO applications. Supports endurance of 1 DWPD (drive write per day). Target applications are boot, streaming media, and collaboration.
4. For all self-encrypting drives (SED), standalone Management (CIMC) and UCSM is supported for configuring and managing local keys. SED drives can be managed with local and remote key management (third-party key management).
5. Two CPUs must be installed in order to include any number of SFF NVMe PCIe SSDs. If you choose one or two PCIe NVMe drives, drive slots 1 and 2 at the front of the chassis are reserved for these drives (see [Figure 2 on page 4](#) for drive slot numbering). With the UCSC-C240-M5SN, you can ONLY have NVME SSDs in front drive bays 1-8.
6. Except HGST, Intel and Western Digital (WD) NVMe drives can be mixed anywhere in a C240 M5.



NOTE: When retrofitting front facing drives with spare NVMe drives, you must order the following along with the spare drives:

- UCSC-PCI-2C-240M5 (Riser 2C)
- CBL-NVME-240SFF= (C240 M5 Front NVMe cable (1) LFF)

Caveats

- You can choose only SATA HDDs when using embedded software RAID. The UCSC-C240-M5SN does not support embedded RAID.
- 2.5-inch SFF NVMe drives are connected directly to the CPU, not managed by the RAID controller.
- You can mix HDDs and SSDs as long as you keep all HDDs in their own RAID volume and all SSDs in their own RAID volume.
- You can mix SAS HDDs and SAS/SATA SSDs when using the Cisco 12G SAS RAID Controller or Cisco 12G SAS HBA.
- If you order any SFF NVMe drives, you must also order two CPUs.
- Except HGST, Intel and Western Digital (WD) NVMe drives can be mixed anywhere in a C240 M5.
- SFF NVMe drives are bootable in UEFI mode only.
- The rear NVMe drives are not bootable.
- SED drives can be mixed with the non-SED drives in [Table 10 on page 33](#)

Select Rear-Facing Drives

The available rear-facing drives are listed in [Table 11](#).

Table 11 Available Hot-Pluggable Sled-Mounted Rear-Facing Drives
(UCSC-C240-M5SX (24-drive system), UCSC-C240-M5S (8-drive system), UCSC-C240-M5SN (24-drive system with SFF NVMe-only for rear-facing drives))

Product ID (PID)	PID Description	Drive Type	Capacity
HDDs			
HDDs (15K RPM)			
UCS-HD300G15K12N	300 GB 12G SAS 15K RPM SFF HDD	SAS	300 GB
UCS-HD600G15K12N	600 GB 12G SAS 15K RPM SFF HDD	SAS	600 GB
UCS-HD900G15K12N	900 GB 12G SAS 15K RPM SFF HDD	SAS	900 GB
HDDs (10K RPM)			
UCS-HD300G10K12N	300 GB 12G SAS 10K RPM SFF HDD	SAS	300 GB
UCS-HD600G10K12N	600 GB 12G SAS 10K RPM SFF HDD	SAS	600 GB
UCS-HD12TB10K12N	1.2 TB 12G SAS 10K RPM SFF HDD	SAS	1.2 TB
UCS-HD18TB10K4KN	1.8 TB 12G SAS 10K RPM SFF HDD (4K)	SAS	1.8 TB
UCS-HD24TB10K4KN	2.4 TB 12G SAS 10K RPM SFF HDD (4K)	SAS	2.4 TB
HDDs (7.2K RPM)			
UCS-HD1T7K12N	1 TB 12G SAS 7.2K RPM SFF HDD	SAS	1 TB
UCS-HD2T7K12N	2 TB 12G SAS 7.2K RPM SFF HDD	SAS	2 TB
UCS-HD1T7K6GAN	1 TB 6G SATA 7.2K RPM SFF HDD	SAS	1 TB
Enterprise Performance SSDs (High endurance, supports up to 10X or 3X DWPD (drive writes per day))			
SAS SSDs			
UCS-SD800GK3X-EP	800 GB 2.5in Enterprise Performance 12G SAS SSD(3X endurance)	SAS	800 GB
UCS-SD16TK3X-EP	1.6 TB 2.5in Enterprise Performance 12G SAS SSD(3X endurance)	SAS	1.6 TB
UCS-SD32TK3X-EP	3.2 TB 2.5in Enterprise Performance 12G SAS SSD(3X endurance)	SAS	3.2 TB
UCS-SD32TKA3X-EP	3.2TB 2.5in Enter Perf 12G SAS Kioxia G2 SSD (3X)	SAS	3.2 TB
SATA SSDs			
UCS-SD480G63X-EP	480GB 2.5 inch Enterprise performance 6GSATA SSD(3X endurance)	SATA	480 GB
UCS-SD960G63X-EP	960GB 2.5in Enterprise performance 6GSATA SSD(3X endurance)	SATA	960 GB
UCS-SD19T63X-EP	1.9TB 2.5in Enterprise performance 6GSATA SSD(3X endurance)	SATA	1.9 TB
UCS-SD19TBM3X-EP	1.9TB 2.5in Enterprise performance 6GSATA SSD(3X endurance)	SATA	1.9 TB
UCS-SD960GBM3X-EP	960GB 2.5in Enterprise performance 6GSATA SSD(3X endurance)	SATA	960 GB
UCS-SD480GBM3X-EP	480GB 2.5in Enterprise Performance 6GSATA SSD(3X endurance)	SATA	480 GB

Table 11 Available Hot-Pluggable Sled-Mounted Rear-Facing Drives (continued)
 (UCSC-C240-M5SX (24-drive system), UCSC-C240-M5S (8-drive system), UCSC-C240-M5SN
 (24-drive system with SFF NVMe-only for rear-facing drives))

Product ID (PID)	PID Description	Drive Type	Capacity
Enterprise Value SSDs (Low endurance, supports up to 1X DWPD (drive writes per day))			
SAS SSDs			
UCS-SD960GK1X-EV	960 GB 2.5 inch Enterprise Value 12G SAS SSD	SAS	960 GB
UCS-SD19TK1X-EV	1.9 TB 2.5 inch Enterprise Value 12G SAS SSD	SAS	1.9 TB
UCS-SD38TK1X-EV	3.8 TB 2.5 inch Enterprise Value 12G SAS SSD	SAS	3.8 TB
UCS-SD76TK1X-EV	7.6 TB 2.5 inch Enterprise Value 12G SAS SSD	SAS	7.6 TB
UCS-SD15TK1X-EV	15.3 TB 2.5 inch Enterprise Value 12G SAS SSD	SAS	15.3 TB
SATA SSDs			
UCS-SD76TBM1X-EV	7.6TB 2.5 inch Enterprise Value 6G SATA SSD	SATA	7.6 TB
UCS-SD38TBM1X-EV	3.8TB 2.5 inch Enterprise Value 6G SATA SSD	SATA	3.8 TB
UCS-SD19TBM1X-EV	1.9TB 2.5 inch Enterprise Value 6G SATA SSD	SATA	1.9 TB
UCS-SD16TBM1X-EV	1.6TB 2.5 inch Enterprise Value 6G SATA SSD	SATA	1.6 TB
UCS-SD960GBM1X-EV	960GB 2.5 inch Enterprise Value 6G SATA SSD	SATA	960 GB
UCS-SD480GBM1X-EV	480 GB 2.5 inch Enterprise Value 6G SATA SSD	SATA	480 GB
UCS-SD240GBM1X-EV	240GB 2.5 inch Enterprise Value 6G SATA SSD	SATA	3.8 TB
UCS-SD480G611X-EV	480GB 2.5 inch Enterprise Value 6G SATA SSD (Intel S4500/S4510)	SATA	480 GB
UCS-SD960G611X-EV	960GB 2.5 inch Enterprise Value 6G SATA SSD (Intel S4500/S4510)	SATA	960 GB
UCS-SD38T611X-EV	3.8TB 2.5 inch Enterprise Value 6G SATA SSD (Intel S4500/S4510)	SATA	3.8 TB
UCS-SD120GM1X-EV	120 GB 2.5 inch Enterprise Value 6G SATA SSD (Micron 5100/5200/5300)	SATA	120 GB
UCS-SD19T61X-EV	1.9 TB 2.5 inch Enterprise Value 6G SATA SSD (Samsung PM863A/PM883)	SATA	1.9 TB
UCS-SD38T61X-EV	3.8 TB 2.5 inch Enterprise Value 6G SATA SSD (Samsung PM863A/PM883)	SATA	3.8 TB
UCS-SD960G6S1X-EV	960GB 2.5 inch Enterprise Value 6G SATA SSD	SATA	960 GB
UCS-SD19T6S1X-EV	1.9TB 2.5 inch Enterprise Value 6G SATA SSD	SATA	1.9 TB
UCS-SD38T6S1X-EV	3.8TB 2.5 inch Enterprise Value 6G SATA SSD	SATA	3.8 TB
UCS-SD76T6S1X-EV	7.6TB 2.5 inch Enterprise Value 6G SATA SSD	SATA	7.6 TB
Self-Encrypted Drives (SED)¹			
SAS			
UCS-HD600G15NK9	600 GB 12G SAS 15K RPM SFF HDD (SED) FIPS140-2	SAS	600 GB
UCS-HD24T10NK9	2.4 TB 12G SAS 10K RPM SFF HDD (4K) (SED) FIPS140-2	SAS	2.4 TB
UCS-HD18T10NK9	1.8 TB 12G SAS 10K RPM SFF HDD (4K format, SED) FIPS140-2	SAS	1.8 TB

Table 11 Available Hot-Pluggable Sled-Mounted Rear-Facing Drives (continued)
 (UCSC-C240-M5SX (24-drive system), UCSC-C240-M5S (8-drive system), UCSC-C240-M5SN
 (24-drive system with SFF NVMe-only for rear-facing drives))

Product ID (PID)	PID Description	Drive Type	Capacity
UCS-HD12T10NK9	1.2 TB 12G SAS 10K RPM SFF HDD (SED) FIPS140-2	SAS	1.2 TB
UCS-SD800GBKNK9	800GB Enterprise Performance SAS SSD (3X DWPD, SED) FIPS140-2	SAS	800 GB
UCS-SD960GBKNK9	960GB Enterprise Value SAS SSD (1X DWPD, SED) FIPS140-2	SAS	960 GB
UCS-SD38TBKNK9	3.8TB Enterprise Value SAS SSD (1X DWPD, SED) FIPS140-2	SAS	3.8 TB
UCS-SD16TBKNK9	1.6TB Enterprise performance SAS SSD (3X DWPD, SED) FIPS140-2	SAS	1.6 TB
UCS-SD76TBKNK9	7.6TB Enterprise value SAS SSD (1 DWPD, SED-FIPS) FIPS140-2	SAS	7.6 TB
PCIe/NVMe SFF (2.5-inch) drives²			
UCSC-NVMEXPB-I375	375 GB 2.5in Intel Optane NVMe Extreme Performance SSD	NVMe	375 GB
UCSC-NVMEXP-I750	750 GB 2.5in Intel Optane NVMe Extreme Performance	NVMe	750 GB
UCSC-NVME2H-I1600	Cisco 2.5" U.2 1.6TB Intel P4610 NVMe High Perf. High Endurance	NVMe	1.6 TB
UCS-NVMEXP-I400	400GB 2.5in U.2 Intel P5800X Optane NVMe Extreme Perform SSD	NVMe	400 GB
UCS-NVMEXP-I800	800GB 2.5in U.2 Intel P5800X Optane NVMe Extreme Perform SSD	NVMe	800 GB
UCS-NVME4-1920	1.9TB 2.5in U.2 15mm P5520 Hg Perf Med End NVMe	NVMe	1,9 TB
UCS-NVME4-3840	3.8TB 2.5in U.2 15mm P5520 Hg Perf Med End NVMe	NVMe	3.8 TB
UCS-NVME4-7680	7.6TB 2.5in U.2 15mm P5520 Hg Perf Med End NVMe	NVMe	7.6 TB
UCS-NVME4-1536	15.3TB 2.5in U.2 15mm P5520 Hg Perf Med End NVMe	NVMe	15.3 TB
UCS-NVMEM6-W3200	3.2TB 2.5in U.2 WD SN840 NVMe Extreme Perf. High Endurance	NVMe	3.2 TB
UCS-NVMEM6-W7680	7.6TB 2.5in U.2 WD SN840 NVMe Extreme Perf. Value Endurance	NVMe	7.6 TB
UCS-NVMEM6-W15300	15.3TB 2.5in U.2 WD SN840 NVMe Extreme Perf. Value Endurance	NVMe	15.3 TB
NOTE: Cisco uses solid state drives from a number of vendors. All solid state drives are subject to physical write limits and have varying maximum usage limitation specifications set by the manufacturer. Cisco will not replace any solid state drives that have exceeded any maximum usage specifications set by Cisco or the manufacturer, as determined solely by Cisco.			

Notes:

- For all self-encrypting drives (SED), standalone Management (CIMC) and UCSM is supported for configuring and managing local keys. SED drives can be managed with local and remote key management (third-party key management).
- Except HGST, Intel and Western Digital (WD) NVMe drives can be mixed anywhere in a C240 M5.



NOTE: When retrofitting rear facing drives with spare NVMe drives, you must order the following along with the spare drives:

- UCSC-PCI-2C-240M5 (Riser 2C) or UCSC-PCI-2B-240M5 (Riser 2B)
- UCSC-RNVME-240M5= (C240 M5 Rear NVMe CBL(1) kit, Rear NVMe CBL, backplane SFF&LFF)

Caveats

- 2.5-inch SFF NVMe drives are connected directly to the CPU, not managed by the RAID controller.
- You can mix HDDs and SSDs as long as you keep all HDDs in their own RAID volume and all SSDs in their own RAID volume.
- You can mix SAS HDDs and SAS/SATA SSDs when using the Cisco 12G SAS RAID Controller or Cisco 12G SAS HBA.
- If you order any SFF NVMe drives, you must also order two CPUs.
- Except HGST, Intel and Western Digital (WD) NVMe drives can be mixed anywhere in a C240 M5.
- SED drives can be mixed with the non-SED drives in [Table 11 on page 37](#).

Intel® Virtual RAID on CPU (Intel® VROC)

The server supports Intel® Virtual RAID on CPU (Intel® VROC). VROC is an enterprise RAID solution used with Intel NVMe SSDs (see [Table 11](#) for supported Intel NVMe SSDs). The Intel® Volume Management Device (Intel® VMD) is a controller integrated into the CPU PCIe root complex. Intel® VMD NVMe SSDs are connected to the CPU, which allows the full performance potential of fast Intel® Optane™ SSDs to be realized. Intel® VROC, when implemented, replaces traditional hardware RAID host bus adapter (HBA) cards placed between the drives and the CPU.



NOTE:

- Intel® VROC is only supported with Intel drives
 - Intel® VROC enablement key factory pre-provisioned to BIOS - no additional licensing required.
-

VROC has the following features:

- Small Form Factor (SFF) drive support (only)
- No battery backup (BBU) or external SuperCap needed
- Software-based solution utilizing Intel SFF NVMe direct connected to Intel CPU
- RAID 0/1/5/10 support
- Windows, Linux, VMware OS support.
- Host Tools- Windows GUI/CLI, Linux CLI.
- UEFI Support- HII Utility, OBSE.
- Intel VROC NVMe operates in UEFI mode only

See the [instructions on setting up and managing VROC for Intel NVMe SSDs](#) for more information.

STEP 7 SELECT PCIe OPTION CARD(s)

For up-to-date server compatibility, please check the Hardware and Software compatibility list (HCL) at <https://ucshcltool.cloudapps.cisco.com/public/>.

The standard PCIe card offerings are:

- Modular LAN on Motherboard (MLOM)
- Virtual Interface Cards (VICs)
- Network Interface Cards (NICs)
- PCIe - Accelerators/Smart NICs
- Host Bus Adapters (HBAs)
- UCS NVMe/PCIe Add-in Storage Cards

Select PCIe Option Cards

The available PCIe option cards are listed in [Table 12](#).

Table 12 Available PCIe Option Cards

Product ID (PID)	PID Description	Location	Electrical slot	Card Height ¹
Modular LAN on Motherboard (mLOM)				
UCSC-MLOM-C100-04	Cisco UCS VIC 1497 Dual Port 40/100G QSFP28 CNA mLOM	mLOM	x16	N/A
UCSC-MLOM-C25Q-04	Cisco UCS VIC 1457 Quad Port 10/25G SFP28 mLOM	mLOM	x16	N/A
UCSC-MLOM-C40Q-03	Cisco UCS VIC 1387 Dual Port 40Gb QSFP+ CNA	mLOM	x8	N/A
UCSC-MLOM-IRJ45	Intel i350 Quad Port 1GBase-T NIC	mLOM	x8	N/A
Virtual Interface Card (VICs)				
UCSC-PCIE-C100-04	Cisco UCS VIC 1495 Dual Port 40/100G QSFP28 CNA PCIe	Riser 1 or 2	x16	HHHL
UCSC-PCIE-C40Q-03	Cisco VIC 1385 Dual Port 40Gb QSFP+ CNA w/RDMA	Riser 1 or 2	x16	HHHL
UCSC-PCIE-C25Q-04	Cisco VIC 1455 VIC PCIe - Quad Port 10/25G SFP28	Riser 1 or 2	x16	HHHL
Network Interface Cards (NICs)				
1 Gb NICs				
UCSC-PCIE-IRJ45	Intel i350 Quad Port 1GBase-T NIC	Riser 1 or 2	x8	HHHL
10 Gb NICs				
N2XX-AIPCI01	Intel X520 Dual Port 10Gb SFP+ NIC	Riser 1 or 2	x8	HHHL
UCSC-PCIE-ID10GC	Intel X550-T2 Dual Port 10GBase-T NIC	Riser 1 or 2	x8	HHHL
UCSC-PCIE-ID10GF	Intel X710-DA2 Dual Port 10Gb SFP+ NIC	Riser 1 or 2	x8	HHHL

Table 12 Available PCIe Option Cards (*continued*)

Product ID (PID)	PID Description	Location	Electrical slot	Card Height ¹
UCSC-PCIE-IQ10GF	Intel X710 Quad Port 10Gb SFP+ NIC	Riser 1 or 2	x8	HHHL
UCSC-PCIE-IQ10GC	Intel X710 Quad Port 10GBase-T NIC	Riser 1 or 2	x8	HHHL
25 Gb NICs				
UCSC-PCIE-QD25GF	Qlogic QL41212H Dual Port 25Gb NIC	Riser 1 or 2	x8	HHHL
UCSC-PCIE-ID25GF	Intel XXV710 Dual Port 25Gb SFP28 NIC	Riser 1 or 2	x8	HHHL
UCSC-P-M4D25GF	Mellanox MCX4121A-ACAT dual port 10/25G SFP28 NIC	Riser 1 or 2	x8	HHHL
UCSC-P-M5D25GF	Mellanox CX-5 EN MCX512A-ACAT 2x25/10GbE SFP PCIe NIC	Riser 1 or 2	x8	HHHL
40 Gb NICs				
UCSC-PCIE-QD40GF	Qlogic QL45412H Dual Port 40Gb NIC	Riser 1 or 2	x16	HHHL
UCSC-PCIE-ID40GF	Intel XL710 Dual Port 40Gb QSFP+ NIC	Riser 1 or 2	x8	HHHL
100 Gb NICs				
UCSC-PCIE-QS100GF	Qlogic QLE45611HLCU single port 100G NIC	Riser 1 or 2	x16	HHHL
UCSC-P-M5D100GF	Mellanox CX-5 MCX516A-CDAT 2x100GbE QSFP PCIe NIC	Riser 1 or 2	x16	HHHL
UCSC-P-M5S100GF	Mellanox CX-5 MCX515A-CCAT 1x100GbE QSFP PCIe NIC	Riser 1 or 2	x16	HHHL
PCIe - Accelerators/Smart NICs				
UCSC-P-IQAT8970	Cisco-Intel 8970 QAT Offload PCIe Adapter	Riser 1 or 2	x16	HHHL
Host Bus Adapters (HBAs)				
UCSC-PCIE-QD16GF	Qlogic QLE2692 Dual Port 16G Fibre Channel HBA	Riser 1 or 2	x8	HHHL
UCSC-PCIE-BD16GF	Emulex LPe31002 Dual Port 16G Fibre Channel HBA	Riser 1 or 2	x8	HHHL
UCSC-PCIE-QD32GF	Qlogic QLE2742 Dual Port 32G Fibre Channel HBA	Riser 1 or 2	x8	HHHL
UCSC-PCIE-BS32GF	Emulex LPe32000-M2 Single Port 32G Fibre Channel HBA	Riser 1 or 2	x8	HHHL
UCSC-PCIE-BD32GF	Emulex LPe32002-M2 Dual Port 32G Fibre Channel HBA	Riser 1 or 2	x8	HHHL

Notes:

1. HHHL= Half Height Half Length

Caveats

- For 1-CPU systems:

- Only PCIe slots 1 and 2 on PCIe riser 1A are available for a 1-CPU system. All three slots (1, 2, and 3) on PCIe riser 1B are available for a 1-CPU system. Slots 1, 2, and 3 are to the left when looking at the rear of the server. Slot 1 is the bottom slot.
 - The PCIe slots on riser 2 are not supported on 1-CPU systems. The riser 2 slots are full-height PCIe slots 4, 5, and 6 (see [Figure 4 on page 6](#)). These are the slots on the right when looking at the rear of the server. Slot 4 is the bottom slot.
 - Only a single plug-in PCIe VIC card may be installed on a 1-CPU system, and it must be installed in slot 2 or 1 of riser 1.
 - You can order an mLOM VIC card to be installed in the mLOM slot internal to the chassis and thus have two VIC cards in operation at the same time. If you order a GPU, it must be installed in slot 2, See [Table 12 on page 42](#) for the selection of plug-in and mLOM VIC cards. See also [Table 1 on page 8](#) and [Riser Card Configuration and Options, page 84](#) or the PCIe slot physical descriptions.
- For 2-CPU systems:
- Six PCIe slots are available, three on PCIe riser 1 or riser 1B (PCIe slots 1, 2, and 3) and three on PCIe riser 2A, 2B or 2C (PCIe slots 4, 5, and 6).
 - Two plug-in PCIe VIC cards can be installed in dual CPU systems, using slots 2 and 5. In addition, you can order an mLOM VIC card, which is installed in the mLOM slot inside the chassis and thus have three VIC cards in operation at the same time. See [Table 12 on page 42](#) for the selection of plug-in and mLOM VIC cards. See also [Table 1 on page 8](#) and [Riser Card Configuration and Options, page 84](#) for the PCIe slot physical descriptions.
 - If GPUs are installed in slots 2 (Riser 1 or 1B) and 5 (Riser 2A or 2B), the NCSI capability automatically switches over to slots 1 (Riser 1 or 1B) and 4 (Riser 2A or 2B). Therefore, Cisco PCIe VICs can be installed in slots 1 and 4 if GPUs are installed in slots 2 and 5. If you order two GPUs, they must be installed in slots 2 and 5 and thus you will not be able to install VIC cards in those slots.



NOTE: UCSM managed servers are discoverable only if a VIC is installed in slot 2 or a VIC is installed in the MLOM slot. If you install two GPUs, they must be located in slots 2 and 5. Therefore, if two GPUs are installed, UCSM managed servers are discoverable only if you install a VIC in the MLOM slot.

- The server supports up to two PCIe Cisco VICs plus an MLOM VIC

However, single wire management is supported on only one VIC at a time. If multiple VICs are installed on a server, only one slot has NCSI enabled at a time and for single wire management, priority goes to the MLOM slot, then slot 2, then slot 5 for NCSI management traffic. When multiple cards are installed, connect the single wire management cables in the priority order mentioned above.
- To help ensure that your operating system is compatible with the card you have selected, or to see additional cards that have been qualified to work with the UCS C240 M5 server, but are not sold on the Cisco price list, check the Hardware Compatibility List at [thi](#)

URL: http://www.cisco.com/en/US/products/ps10477/prod_technical_reference_list.html



NOTE: Mixing 1300 and 1400 series VIC and MLOMs configurations is not supported.

PCIe Card Configuration with 2 CPU

Below table helps in finding the right slot for the selected PCIe cards.

Table 13 PCIe Card Configuration with 2 CPU

PCIe Card Type	Primary Slot	Secondary Slot	Alternate Slot
Cisco12G Modular RAID controller	Midplane Slot	None	
Cisco 12G 9460-8i Raid controller	10	None	
PCIe Switch card	10	None	
Cisco x16 VIC (Cisco VIC 1385)	1	2	8, 5
Nvidia and AMD GPUs	2	8	10, 1
Other 16x PCIe I/O card	8	10	2, 1
Other 8x PCIe I/O card	9	5	8, 2, 10, 1
Cisco x16 VIC	1	2	8



NOTE:

- Slot 1 only if no VIC present
- When no VIC presents in the configuration, GPU primary slot could be 1
- First VIC has the highest priority, then GPUs, then others.
- Primary Slots are first priorities
- Secondary slots are for additional card of the same type, follow the order listed
- Alternate slots can be used but may be with reduced functionality

STEP 8 ORDER OPTIONAL PCIe OPTION CARD ACCESSORIES

- These optics and cables have been tested for compatibility and are approved for use with Intel® Ethernet Network Adapter (as of the time of this publication). For the latest update, check the and consult Cisco Compatibility Matrix at <https://tmgmatrix.cisco.com>.
- For list of supported optics and cables for VIC1385, VIC 1387, VIC 1440, VIC 1455, VIC 1457, VIC 1495 and VIC 1497 refer to VIC 1300 and VIC 1400 series data sheet at the following links:
 - <https://www.cisco.com/c/en/us/products/collateral/interfaces-modules/unified-computing-system-adapters/datasheet-c78-741130.html>
 - <https://www.cisco.com/c/en/us/products/interfaces-modules/ucs-virtual-interface-card-1387/index.html>
 - <https://www.cisco.com/c/en/us/products/collateral/interfaces-modules/unified-computing-system-adapters/datasheet-c78-734727.html>

Refer to the these links for additional Connectivity Options.

Intel:	Marvell/Qlogic:	Mellanox:
Product Guide	41000 series Interoperability Matrix	Firmware Release Notes
Speed White Paper	45000 series Interoperability Matrix	

STEP 9 ORDER GPU CARDS (OPTIONAL)

Select GPU Options

The available GPU PCIe options are listed in [Table 14](#).

Table 14 Available PCIe GPU Cards

Product ID (PID)	PID Description	Card Size	Maximum cards Per node
GPU PCIe Cards¹			
UCSC-GPU-T4-16	NVIDIA T4 16GB	Low Profile Single-Width	6
UCSC-GPU-M10	NVIDIA M10	Full-Height Dual Width	2
UCSC-GPU-A100-80	TESLA A100, PASSIVE, 300W, 80GB	Full-Height Dual Width	2

Notes:

1. Refer to [C240 M5 GPU Card Installation](#) for more details.



CAUTION:

- When using the GPU cards, The maximum allowable operating temperature for M10 GPUs is 35° C (95.0° F)
- For the complete operating temperature requirement of double-wide GPUs Please refer to **table 2** of the below url:
https://www.cisco.com/c/en/us/td/docs/unified_computing/ucs/c/hw/C240M5/install/C240M5/C240M5_appendix_0101.html



NOTE:

- All GPU cards must be procured from Cisco as there is a unique SBIOS ID required by CIMC and UCSM
- All GPU cards require two CPUs and a minimum of two power supplies in the server. 1600 W power supplies are recommended. Use the power calculator at the following link to determine the needed power based on the options chosen (CPUs, drives, memory, and so on):
- UCSC-C240-M5SN only supports GPU on Riser 1

<http://ucspowercalc.cisco.com>

Caveats

- NVIDIA M10 can support only less than 1TB of total memory in the server.
- GPUs cannot be mixed.
- Slot 5 on riser card 2 is the required slot for the first GPU
- Slot 2 on riser card 1 is the secondary slot for a second GPU
- For the GPU Required Power Cables info please refer to the **table 3** of the below url:
https://www.cisco.com/c/en/us/td/docs/unified_computing/ucs/c/hw/C240M5/install/C240M5/C240M5_appendix_0101.htm

Refer to **Table 15** for the PCIe slot usage for the following PCIe cards installed in riser 1 and riser 2:

- External RAID
- VIC
- NIC
- HBA
- GPU
- NVMe HDDL

Table 15 PCIe Slot Usage in Riser 1 (slots 1, 2, 3) and Riser 2 (slots 4, 5, 6)

Riser Combinations	Total Riser Slots Available		Riser Slots Available for GPUs	
	1-CPU System	2-CPU System	1-CPU System	2-CPU System
1A only	Slots 1 and 2	Slots 1, 2, and 3	Slot 2	Slot 2
1B only	Slots 1, 2, and 3	Slots 1, 2, and 3	None	None
1A and 2A	Slots 1 and 2	Slots 1, 2, 3, 4, 5, and 6	Slot 2	Slots 2 and 5
1A and 2B	Slots 1 and 2	Slots 1, 2, 3, 4, 5, and 6	Slot 2	Slots 2 and 5
1A and 2C	Slots 1 and 2	Slots 1, 2, 3, 4, 5, and 6	Slot 2	Slot 2
1A and 2D	Slots 1 and 2	Slots 1, 2, 3, 4, 5, and 6	Slot 2	Slot 2
1B and 2A	Slots 1 and 2	Slots 1, 2, 3, 4, 5, and 6	None	Slot 5
1B and 2B	Slots 1 and 2	Slots 1, 2, 3, 4, 5, and 6	None	Slot 5
1B and 2C	Slots 1 and 2	Slots 1, 2, 3, 4, 5, and 6	None	None
1B and 2D	Slots 1 and 2	Slots 1, 2, 3, 4, 5, and 6	None	None



NOTE:

- UCSM managed servers are discoverable only if a PCIe VIC card is installed in slot 2 or an mLOM VIC card is installed in the mLOM slot. If you install two GPUs, they must be located in slots 2 and 5. Therefore, if two GPUs are installed, UCSM managed servers are discoverable only if you install a VIC in the MLOM slot.
- For more information on the riser card options, see [Riser Card Configuration and Options, page 84](#)

STEP 10 ORDER POWER SUPPLY

Power supplies share a common electrical and physical design that allows for hot-plug and tool-less installation into M5 C-series servers. Each power supply is certified for high-efficiency operation and offer multiple power output options. This allows users to “right-size” based on server configuration, which improves power efficiency, lower overall energy costs and avoid stranded capacity in the data center. Use the power calculator at the following link to determine the needed power based on the options chosen (CPUs, drives, memory, and so on):

<http://ucspowercalc.cisco.com>

Table 16 Power Supply

Product ID (PID)	PID Description
UCSC-PSU1-770W	770W power supply for C-Series Servers Platinum
UCSC-PSU1-1050W	1050W AC power supply for C-Series servers Platinum
UCSC-PSUV2-1050DC	1050W DC power supply for C-Series servers Platinum
UCSC-PSU1-1600W ¹	1600W power supply for C-Series servers Platinum
UCSC-PSU1-1050ELV	1050W AC Power Supply C-Series Enhanced Low Line Platinum

Notes:

1. PSU supported on C220/C240/HX



NOTE: In a two power supply server, both power supplies must be identical.

STEP 11 SELECT INPUT POWER CORD(S)

Using [Table 17](#), select the appropriate AC power cords. You can select a minimum of no power cords and a maximum of two.

Table 17 Available Power Cords

Product ID (PID)	PID Description	Images
NO-POWER-CORD	ECO friendly green option, no power cable will be shipped	Not applicable
CAB-48DC-40A-8AWG	C-Series -48VDC PSU Power Cord, 3.5M, 3 Wire, 8AWG, 40A	
CAB-N5K6A-NA	Power Cord, 200/240V 6A, North America	
CAB-AC-L620-C13	AC Power Cord, NEMA L6-20 - C13, 2M/6.5ft	
CAB-C13-CBN	CABASY,WIRE,JUMPER CORD, 27" L, C13/C14, 10A/250V	
CAB-C13-C14-2M	CABASY,WIRE,JUMPER CORD, PWR, 2 Meter, C13/C14,10A/250V	
CAB-C13-C14-AC	CORD,PWR,JMP,IEC60320/C14,IEC60320/C13, 3.0M	

Table 17 Available Power Cords

Product ID (PID)	PID Description	Images
CAB-250V-10A-AR	Power Cord, 250V, 10A, Argentina	 <p>Plug: EL 219 (IRAM 2073)</p> <p>Cordset rating: 10 A, 250/500 V MAX Length: 2500 mm Length: 8.2 ft</p> <p>Connector: EL 701 (IEC60320/C13)</p>
CAB-9K10A-AU	Power Cord, 250VAC 10A 3112 Plug, Australia	 <p>Plug: EL 210 (BS 1363A) 13 AMP fuse</p> <p>Cordset rating: 10 A, 250 V/500 V MAX Length: 2500mm</p> <p>Connector: EL 701C (EN 60320/C15)</p>
CAB-250V-10A-CN	AC Power Cord - 250V, 10A - PRC	 <p>Plug: M2511</p> <p>Cordset rating: 10A/16 A, 250 V Length: 8 ft 2 in. (2.5 m)</p> <p>Connector: VSCC15</p>
CAB-9K10A-EU	Power Cord, 250VAC 10A CEE 7/7 Plug, EU	 <p>Plug: EL 208</p> <p>Cordset rating 16A, 250V (2500mm)</p> <p>Connector: EL 701</p>
CAB-250V-10A-ID	Power Cord, SFS, 250V, 10A, India	 <p>Plug: EL 212 (SI-32)</p> <p>Cordset rating 10A, 250V/500V MAX (2500 mm)</p> <p>Connector: EL 701B (IEC60320/C13)</p>
CAB-9K10A-IT	Power Cord, 250VAC 10A CEI 23-16/VII Plug, Italy	 <p>Plug: I/3G (CEI 23-16)</p> <p>Cordset rating: 10 A, 250 V Length: 8 ft 2 in. (2.5 m)</p> <p>Connector: C15M (EN60320/C15)</p>

Table 17 Available Power Cords

Product ID (PID)	PID Description	Images
CAB-9K10A-SW	Power Cord, 250VAC 10A MP232 Plug, Switzerland	
CAB-9K10A-UK	Power Cord, 250VAC 10A BS1363 Plug (13 A fuse), UK	
CAB-9K12A-NA ¹	Power Cord, 125VAC 13A NEMA 5-15 Plug, North America	
CAB-250V-10A-BR	Power Cord - 250V, 10A - Brazil	
CAB-C13-C14-2M-JP	Power Cord C13-C14, 2M/6.5ft Japan PSE mark	Image not available
CAB-9K10A-KOR ¹	Power Cord, 125VAC 13A KSC8305 Plug, Korea	Image not available
CAB-ACTW	AC Power Cord (Taiwan), C13, EL 302, 2.3M	Image Not available
CAB-JPN-3PIN	Japan, 90-125VAC 12A NEMA 5-15 Plug, 2.4m	Image Not available
CAB-48DC-40A-INT	-48VDC PSU PWR Cord, 3.5M, 3 Wire, 8AWG, 40A (INT)	Image Not available
CAB-48DC-40A-AS	-48VDC PSU PWR Cord, 3.5M, 3Wire, 8AWG, 40A (AS/NZ)	Image Not available
CAB-C13-C14-IN	Power Cord Jumper, C13-C14 Connectors, 1.4 Meter Length, India	Image Not available
CAB-C13-C14-3M-IN	Power Cord Jumper, C13-C14 Connectors, 3 Meter Length, India	Image Not available

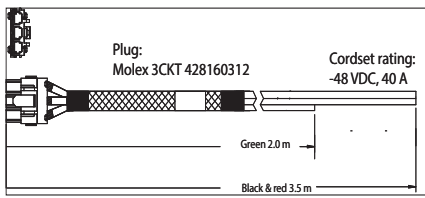
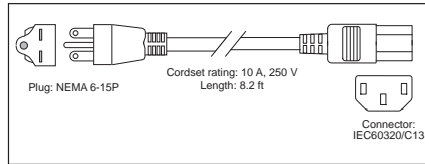
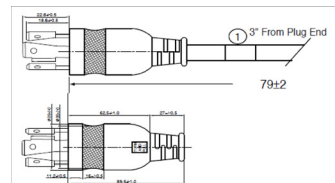
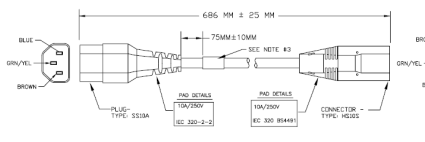
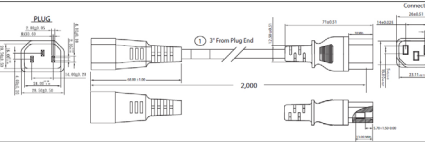
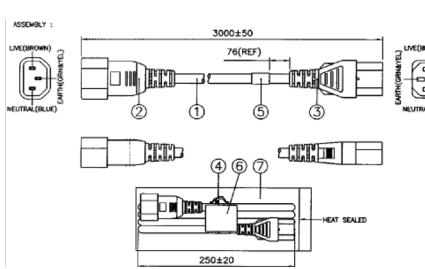
Notes:

1. This power cord is rated to 125V and only supported for PSU rated at 1050W or less

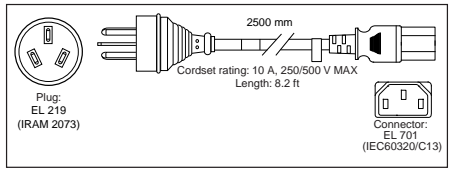
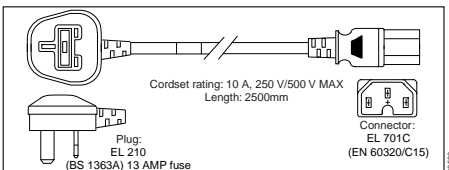
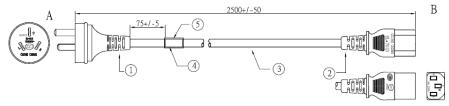
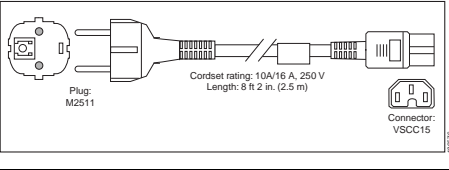
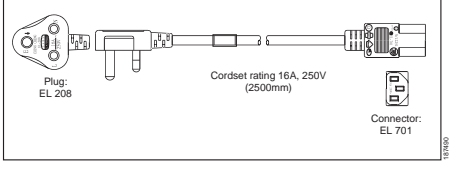
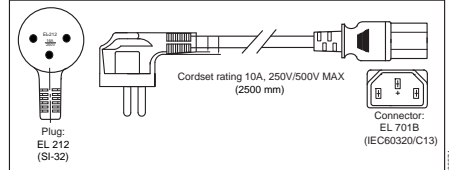
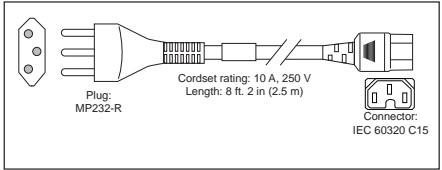
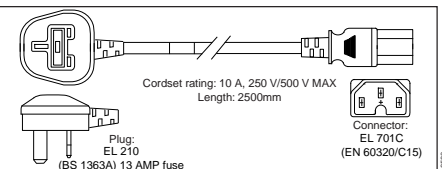
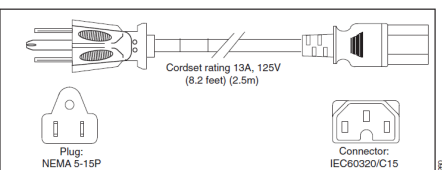
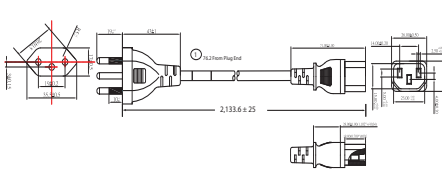
STEP 12 ORDER TOOL-LESS RAIL KIT AND OPTIONAL REVERSIBLE CABLE MANAGEMENT ARM

Select a Tool-less Rail Kit

Select a tool-less rail kit from [Table 18](#).

Table 18 Tool-less Rail Kit Options

Product ID (PID)	PID Description
UCSC-RAILB-M4	Ball Bearing Rail Kit for C240 M5 Rack Servers
UCSC-RAIL-NONE	No rail kit option

Select an Optional Reversible Cable Management Arm

The reversible cable management arm mounts on either the right or left slide rails at the rear of the server and is used for cable management. Use [Table 19](#) to order a cable management arm.

Table 19 Cable Management Arm

Product ID (PID)	PID Description
UCSC-CMA-M4	Reversible CMA for tool-less C240M5 ball bearing rail kit

For more information about the tool-less rail kit and cable management arm, see the Cisco UCS C240 M5 Installation and Service Guide at this URL:

https://www.cisco.com/c/en/us/td/docs/unified_computing/ucs/c/hw/C240M5/install/C240M5.html



NOTE: If you plan to rackmount your UCS C240 M5 server, you must order a tool-less rail kit. The same rail kits and CMAs are used for C240 M4 and C240 M5 servers.

STEP 13 SELECT MANAGEMENT CONFIGURATION (OPTIONAL)

By default, the C240 M5 server NIC mode is configured to be Shared LOM Extended. This NIC mode allows any LOM port or adapter card port to be used to access the Cisco Integrated Management Controller (CIMC). The Cisco VIC card must be installed in a slot with NCSI support.

To change the default NIC mode to Dedicated, select the UCSC-DLOM-01 PID shown in [Table 20](#). In Dedicated NIC mode, the CIMC can be accessed only through the dedicated management port. See [Chassis Rear View, page 6](#) for the location of the management port.

To change the default NIC mode to Cisco Card Mode, select the UCSC-CCARD-01 PID shown in [Table 20](#). In this mode, you can assign an IP address to the CIMC using DHCP and from there you can fully automate your deployment.

For more details on all the NIC mode settings, see

https://www.cisco.com/c/en/us/td/docs/unified_computing/ucs/c/hw/C240M5/install/C240M5/C240M5_chapter_01.html#concept_rqj_vsr_fz

Table 20 Management Configuration Ordering Information

PID Description	
UCSC-DLOM-01	Dedicated Mode BIOS setting for C-Series Servers
UCSC-CCARD-01	Cisco Card Mode BIOS setting for C-Series Servers

STEP 14 SELECT SERVER BOOT MODE (OPTIONAL)

By default, the C240 M5 server ships with UEFI as the default boot mode. To have a server shipped with the Legacy BIOS mode (which was standard on M4 and previous generation servers), select the Legacy BIOS PID from [Table 21](#).

Table 21 Server Boot Mode Ordering Information

Product ID (PID)	PID Description
UCSC-LBIOS-01	Legacy Boot Mode BIOS setting for C-Series Servers

STEP 15 SELECT LOCKING SECURITY BEZEL (OPTIONAL)

An optional locking bezel can be mounted to the front of the chassis to prevent unauthorized access to the drives.

Select the locking bezel from [Table 22](#).

Table 22 Locking Bezel Option

Product ID (PID)	Description
UCSC-BZL-C240M5	C240 M5 Security Bezel

STEP 16 ORDER SECURITY DEVICES (OPTIONAL)

A Trusted Platform Module (TPM) is a computer chip (microcontroller) that can securely store artifacts used to authenticate the platform (server). These artifacts can include passwords, certificates, or encryption keys. A TPM can also be used to store platform measurements that help ensure that the platform remains trustworthy. Authentication (ensuring that the platform can prove that it is what it claims to be) and attestation (a process helping to prove that a platform is trustworthy and has not been breached) are necessary steps to ensure safer computing in all environments.

A chassis intrusion switch gives a notification of any unauthorized mechanical access into the server.

The security device ordering information is listed in [Table 23](#).

Table 23 Security Devices

Product ID (PID)	PID Description
UCSX-TPM2-001	Trusted Platform Module 1.2 SPI-based for UCS Servers
UCSX-TPM2-002	Trusted Platform Module 2.0 for UCS servers
UCSX-TPM2-002B	Trusted Platform Module 2.0 M5 UCS Servers (FIPS 140-2 Compliant)
UCSC-INT-SW01	C220 M5 and C240 M5 Chassis Intrusion Switch



NOTE:

- The TPM module used in this system conforms to TPM v1.2 and 2.0, as defined by the Trusted Computing Group (TCG). It is also SPI-based.
- TPM installation is supported after-factory. However, a TPM installs with a one-way screw and cannot be replaced, upgraded, or moved to another server. If a server with a TPM is returned, the replacement server must be ordered with a new TPM.

STEP 17 ORDER OPTICAL DRIVE (OPTIONAL)

Order an optical drive (DVD). See [Table 24](#).

Table 24 Optical (DVD) Drive

Product ID (PID)	PID Description
UCSC-DVD-C240M5	Media Drive (DVD) for C240 M5 Servers (8-HDD version only)

Caveats

You can order a DVD drive only for the UCSC-C240-M5S (8-HDD backplane version of the server).

STEP 18 ORDER CISCO SD CARD MODULE (OPTIONAL)

Order one or two matching SD cards. See [Figure 6 on page 78](#) for the location of the mini storage module connector, which accommodates an SD module. Each SD module accommodates two SD cards.

Table 25 Secure Digital (SD) Card (blank)

Product ID (PID)	PID Description
UCS-SD-128G	128 GB SD Card for UCS Servers
UCS-SD-64G-S	64 GB SD Card for UCS Servers
UCS-SD-32G-S	32 GB SD Card for UCS Servers



NOTE: Starting from vSphere 8.0, SD cards/USB media as a standalone boot device will not be supported by VMware. For more information please refer to the VMware KB article: <https://kb.vmware.com/s/article/85685>

Caveats

- Install either one or two SD cards
- Do not mix SD card sizes
- You cannot mix SD cards with an internal M.2 SATA SSD (see [ORDER M.2 SATA SSD \(OPTIONAL\), page 61](#)).

STEP 19 ORDER M.2 SATA SSD (OPTIONAL)

Order one or two matching M.2 SATA SSDs (see [Table 26](#)) along with a mini storage carrier or a boot-optimized RAID controller (see [Table 27](#)).



NOTE: It is recommended that M.2 SATA SSDs be used as boot-only devices.

Each mini storage carrier or boot-optimized RAID controller can accommodate up to two SATA M.2 SSDs shown in [Table 26](#).

Table 26 M.2 SATA SSDs

Product ID (PID)	PID Description
UCS-M2-I240GB	240 GB M.2 SATA SSD
UCS-M2-I480GB	480 GB M.2 SATA SSD
UCS-M2-240G	240GB SATA M.2
UCS-M2-480G	480GB M.2 SATA SSD
UCS-M2-960G	960GB SATA M.2

Table 27 Mini Storage Carrier/Boot-Optimized RAID Controller

Product ID (PID)	PID Description
UCS-MSTOR-M2	Mini Storage Carrier for M.2 SATA (holds up to 2 M.2 SATA SSDs)
UCS-M2-HWRAID	Cisco Boot optimized M.2 RAID controller (holds up to 2 M.2 SATA SSDs)



NOTE:

- The UCS-M2-HWRAID boot-optimized RAID controller supports RAID 1 and JBOD mode
- The UCS-M2-HWRAID controller is available only with 240 GB, 960 GB or 480 GB M.2 SSDs.
- (CIMC/UCSM) is supported for configuring of volumes and monitoring of the controller and installed SATA M.2 drives
- The minimum version of Cisco IMC and Cisco UCS Manager that support this controller is 4.0(4b) and later. The name of the controller in the software is MSTOR-RAID
- The SATA M.2 drives can boot in UEFI mode only. Legacy boot mode is not supported
- Hot-plug replacement is not supported. The server must be powered off.
- The boot-optimized RAID controller is not supported when the server is used as a compute node in HyperFlex configurations

- Order either the Mini Storage carrier or the Boot-Optimized RAID controller from [Table 27](#).
 - Choose the UCS-MSTOR-M2 mini storage carrier for controlling the M.2 SATA drives with no RAID control.
 - Choose the UCS-M2-HWRAID Boot-Optimized RAID controller for hardware RAID across the two internal SATA M.2 drives. The Boot-Optimized RAID controller holds up to 2 matching M.2 SATA drives.
- Order up to two matching M.2 SATA SSDs from [Table 26](#).



NOTE: The Boot-Optimized RAID controller supports VMWare, Windows and Linux Operating Systems

Caveats

- You cannot mix M.2 SATA SSDs with SD cards.
- Order either one or two identical M.2 SATA SSDs for the mini-storage carrier or boot-optimized RAID controller. You cannot mix M.2 SATA SSD capacities.

When ordering two M.2 SATA drives with embedded software RAID, the maximum number of internal SATA drives supported is six. To support greater than six internal drives, a Cisco 12G Raid Controller or a Cisco 12G SAS HBA must be ordered

STEP 20 ORDER INTERNAL MICRO-SD CARD MODULE (OPTIONAL)

Order a 32 GB micro-SD card. The micro-SD card serves as a dedicated local resource for utilities such as a Host Upgrade Utility (HUU). Images can be pulled from a file share (NFS/CIFS) and uploaded to the card for future use.

Table 28 32 GB Secure Digital (SD) Card

Product ID (PID)	PID Description
UCS-MSD-32G	32GB Micro-SD Card for UCS servers

NOTE:

- The microSD card mounts internally on riser 1 or riser 1B, so you must order either UCSC-PCI-1-C240M5 or UCSC-PCI-1B-C240M5 when you order a micro-SD card.
- Flexutil user partition does not support OS installation. The user partition must be used for storage only.

STEP 21 ORDER OPTIONAL USB 3.0 DRIVE

You can order one optional USB 3.0 drive. The USB drive ordering information is listed in [Table 29](#).

Table 29 USB 3.0 Drive

Product ID (PID)	PID Description
UCS-USBFLSHB-16GB	UCS Servers 16 GB Flash USB Drive

See [Figure 6 on page 78](#) for the location of the USB connector

STEP 22 SELECT OPERATING SYSTEM AND VALUE-ADDED SOFTWARE

For more details on supported operating systems and software for this server, see the Hardware and Software Compatibility List (HCL).

Note: PIDs tagged with an asterisk (*) are Resell of an OEM Vendor's Support. They are required to be added to the associated Product License PID.



NOTE: VMware is on Compliance Hold. Contact the Compute-Vmware-Hold@cisco.com mailer to see if you are allowed to receive VMware Licenses

Select

- Cisco Software ([Table 30](#))
- OEM Software ([Table 31](#))
- Operating System ([Table 32](#))

Table 30 Cisco Software

Product ID (PID)	PID Description
IMC Supervisor	
CIMC-SUP-BASE-K9	IMC Supervisor One-time Site Installation License
CIMC-SUP-B01	IMC Supervisor-Branch Mgt SW for C-Series & E-Series up to 100 Svrs
CIMC-SUP-B02	IMC Supervisor- Branch Mgt SW for C and E-Series up to 250 Svrs
CIMC-SUP-B10	IMC Supervisor- Branch Mgt SW for C and E-Series up to 1K Svrs
CIMC-SUP-B25	IMC Supervisor Branch Mgt SW for C and E-Series 25 Svrs
CIMC-SUP-A01	IMC Supervisor Adv-Branch Mgt SW for C and E-Series 100 Svrs
CIMC-SUP-A02	IMC Supervisor Adv-Branch Mgt SW for C and E-Series 250 Svrs
CIMC-SUP-A10	IMC Supervisor Adv-Branch Mgt SW for C and E-Series 1000 Svrs
CIMC-SUP-A25	IMC Supervisor Adv-Branch Mgt SW for C and E-Series 25 Svrs
EVAL-CIMC-SUP-BAS	EVAL: IMC Supervisor One-time Site Installation License
EVAL-CIMC-SUP	EVAL: IMC Supervisor-Branch Mgt SW for C/E-Series - 50 Svrs
UCS Multi-Domain Manager	
UCS-MDMGR-1S	UCS Central Per Server License
NOTE: IF you must order quantity greater than 1 of UCS-MDMGR-1S, you need to reference the UCS Central Per Server Data Sheet to order the standalone PIDs: UCS-MDMGR-LIC= or UCS-MDMGR-1DMN=	

Table 31 OEM Software

Product ID (PID)	PID Description
VMware vCenter	
VMW-VCS-STD-1A	VMware vCenter 7 Server Standard, 1 yr support require
VMW-VCS-STD-3A	VMware vCenter 7 Server Standard, 3 yr support required
VMW-VCS-STD-5A	VMware vCenter 7 Server Standard, 5 yr support required
VMW-VCS-FND-1A	VMware vCenter 7 Server Foundation (4 Host), 1 yr supp reqd
VMW-VCS-FND-3A	VMware vCenter 7 Server Foundation (4 Host), 3 yr supp reqd
VMW-VCS-FND-5A	VMware vCenter 7 Server Foundation (4 Host), 5 yr supp reqd

Table 32 Operating System

Product ID (PID)	PID Description
Microsoft Windows Server	
MSWS-19-DC16C	Windows Server 2019 Data Center (16 Cores/Unlimited VMs)
MSWS-19-DC16C-NS	Windows Server 2019 DC (16 Cores/Unlim VMs) - No Cisco SVC
MSWS-19-ST16C	Windows Server 2019 Standard (16 Cores/2 VMs)
MSWS-19-ST16C-NS	Windows Server 2019 Standard (16 Cores/2 VMs) - No Cisco SVC
MSWS-22-ST16C	Windows Server 2022 Standard (16 Cores/2 VMs)
MSWS-22-ST16C-NS	Windows Server 2022 Standard (16 Cores/2 VMs) - No Cisco SVC
MSWS-22-DC16C	Windows Server 2022 Data Center (16 Cores/Unlimited VMs)
MSWS-22-DC16C-NS	Windows Server 2022 DC (16 Cores/Unlim VMs) - No Cisco SVC
Red Hat	
RHEL-2S2V-1A	Red Hat Enterprise Linux (1-2 CPU,1-2 VN); 1-Yr Support Req
RHEL-2S2V-3A	Red Hat Enterprise Linux (1-2 CPU,1-2 VN); 3-Yr Support Req
RHEL-2S2V-5A	Red Hat Enterprise Linux (1-2 CPU,1-2 VN); 5-Yr Support Req
RHEL-VDC-2SUV-1A	RHEL for Virt Datacenters (1-2 CPU, Unlim VN) 1 Yr Supp Req
RHEL-VDC-2SUV-3A	RHEL for Virt Datacenters (1-2 CPU, Unlim VN) 3 Yr Supp Req
RHEL-VDC-2SUV-5A	RHEL for Virt Datacenters (1-2 CPU, Unlim VN) 5 Yr Supp Req
Red Hat Ent Linux/ High Avail/ Res Strg/ Scal	

Table 32 (continued) Operating System

Product ID (PID)	PID Description
RHEL-2S2V-1S	Red Hat Enterprise Linux (1-2 CPU, 1-2 VN); Prem 1-Yr SnS
RHEL-2S2V-3S	Red Hat Enterprise Linux (1-2 CPU, 1-2 VN); Prem 3-Yr SnS
RHEL-2S-HA-1S	RHEL High Availability (1-2 CPU); Premium 1-yr SnS
RHEL-2S-HA-3S	RHEL High Availability (1-2 CPU); Premium 3-yr SnS
RHEL-2S-RS-1S	RHEL Resilient Storage (1-2 CPU); Premium 1-yr SnS
RHEL-2S-RS-3S	RHEL Resilient Storage (1-2 CPU); Premium 3-yr SnS
RHEL-VDC-2SUV-1S	RHEL for Virt Datacenters (1-2 CPU, Unlim VN) 1 Yr SnS Reqd
RHEL-VDC-2SUV-3S	RHEL for Virt Datacenters (1-2 CPU, Unlim VN) 3 Yr SnS Reqd
Red Hat SAP	
RHEL-SAP-2S2V-1S	RHEL for SAP Apps (1-2 CPU, 1-2 VN); Prem 1-Yr SnS Reqd
RHEL-SAP-2S2V-3S	RHEL for SAP Apps (1-2 CPU, 1-2 VN); Prem 3-Yr SnS Reqd
RHEL-SAPSP-3S	RHEL SAP Solutions Premium - License with 3 Years of SnS
RHEL-SAPSS-3S	RHEL SAP Solutions Standard - License with 3 Years of SnS
VMware	
VMW-VSP-STD-1A	VMware vSphere 7 Std (1 CPU, 32 Core) 1-yr, Support Required
VMW-VSP-STD-3A	VMware vSphere 7 Std (1 CPU, 32 Core) 3-yr, Support Required
VMW-VSP-STD-5A	VMware vSphere 7 Std (1 CPU, 32 Core) 5-yr, Support Required
VMW-VSP-EPL-1A	VMware vSphere 7 Ent Plus (1 CPU, 32 Core) 1Yr, Support Reqd
VMW-VSP-EPL-3A	VMware vSphere 7 Ent Plus (1 CPU, 32 Core) 3Yr, Support Reqd
VMW-VSP-EPL-5A	VMware vSphere 7 Ent Plus (1 CPU, 32 Core) 5Yr, Support Reqd
SUSE	
SLES-2S2V-1A	SUSE Linux Enterprise Svr (1-2 CPU, 1-2 VM); 1-Yr Support Req
SLES-2S2V-3A	SUSE Linux Enterprise Svr (1-2 CPU, 1-2 VM); 3-Yr Support Req
SLES-2S2V-5A	SUSE Linux Enterprise Svr (1-2 CPU, 1-2 VM); 5-Yr Support Req4.0(4b)4.0(4b)
SLES-2S2V-1S	SUSE Linux Enterprise Svr (1-2 CPU, 1-2 VM); Prio 1-Yr SnS
SLES-2SUV-3S	SUSE Linux Enterprise Svr (1-2 CPU, Unl VM); Prio 3-Yr SnS
SLES-2SUV-5S	SUSE Linux Enterprise Svr (1-2 CPU, Unl VM); Prio 5-Yr SnS
SLES-2S-HA-1S	SUSE Linux High Availability Ext (1-2 CPU); 1yr SnS
SLES-2S-HA-3S	SUSE Linux High Availability Ext (1-2 CPU); 3yr SnS

Table 32 (continued) Operating System

Product ID (PID)	PID Description
SLES-2S-HA-5S	SUSE Linux High Availability Ext (1-2 CPU); 5yr SnS
SLES-2S-GC-1S	SUSE Linux GEO Clustering for HA (1-2 CPU); 1yr Sns
SLES-2S-GC-3S	SUSE Linux GEO Clustering for HA (1-2 CPU); 3yr SnS
SLES-2S-GC-5S	SUSE Linux GEO Clustering for HA (1-2 CPU); 5yr SnS
SLES-2S-LP-1S	SUSE Linux Live Patching Add-on (1-2 CPU); 1yr SnS Required
SLES-2S-LP-3S	SUSE Linux Live Patching Add-on (1-2 CPU); 3yr SnS Required
SLES-2S-LP-1A	SUSE Linux Live Patching Add-on (1-2 CPU); 1yr Support Req
SLES-2S-LP-3A	SUSE Linux Live Patching Add-on (1-2 CPU); 3yr Support Req
SLES and SAP	
SLES-SAP-2S2V-1A	SLES for SAP Apps (1-2 CPU, 1-2 VM); 1-Yr Support Reqd
SLES-SAP-2S2V-3A	SLES for SAP Apps (1-2 CPU, 1-2 VM); 3-Yr Support Reqd
SLES-SAP-2S2V-5A	SLES for SAP Apps (1-2 CPU, 1-2 VM); 5-Yr Support Reqd
SLES-SAP-2S2V-1S	SLES for SAP Apps (1-2 CPU, 1-2 VM); Priority 1-Yr SnS
SLES-SAP-2S2V-3S	SLES for SAP Apps (1-2 CPU, 1-2 VM); Priority 3-Yr SnS
SLES-SAP-2S2V-5S	SLES for SAP Apps (1-2 CPU, 1-2 VM); Priority 5-Yr SnS

STEP 23 SELECT OPERATING SYSTEM MEDIA KIT

Select the optional operating system media listed in [Table 33](#).

Table 33 OS Media

Product ID (PID)	PID Description
MSWS-19-ST16C-RM	Windows Server 2019 Stan (16 Cores/2 VMs) Rec Media DVD Only
MSWS-19-DC16C-RM	Windows Server 2019 DC (16Cores/Unlim VM) Rec Media DVD Only

STEP 24 SELECT SERVICE and SUPPORT LEVEL

A variety of service options are available, as described in this section.

Unified Computing Warranty, No Contract

If you have noncritical implementations and choose to have no service contract, the following coverage is supplied:

- Three-year parts coverage.
- Next business day (NBD) parts replacement eight hours a day, five days a week.
- 90-day software warranty on media.
- Downloads of BIOS, drivers, and firmware updates.
- UCSM updates for systems with Unified Computing System Manager. These updates include minor enhancements and bug fixes that are designed to maintain the compliance of UCSM with published specifications, release notes, and industry standards.

Smart Net Total Care (SNTC) for UCS

For support of the entire Unified Computing System, Cisco offers the Cisco Smart Net Total Care for UCS Service. This service provides expert software and hardware support to help sustain performance and high availability of the unified computing environment. Access to Cisco Technical Assistance Center (TAC) is provided around the clock, from anywhere in the world

For systems that include Unified Computing System Manager, the support service includes downloads of UCSM upgrades. The Cisco Smart Net Total Care for UCS Service includes flexible hardware replacement options, including replacement in as little as two hours. There is also access to Cisco's extensive online technical resources to help maintain optimal efficiency and uptime of the unified computing environment. For more information please refer to the following url: <http://www.cisco.com/c/en/us/services/technical/smart-net-total-care.html?stickynav=1>

You can choose a desired service listed in [Table 34](#).

Table 34 Cisco SNTC for UCS Service (PID UCSC-C240-M5SX)

Service SKU	Service Level GSP	On Site?	Description
CON-PREM-C240M5SX	C2P	Yes	SNTC 24X7X20S
CON-UCSD8-C240M5SX	UCSD8	Yes	UC SUPP DR 24X7X20S*
CON-C2PL-C240M5SX	C2PL	Yes	LL 24X7X20S**
CON-OSP-C240M5SX	C4P	Yes	SNTC 24X7X40S
CON-UCSD7-C240M5SX	UCSD7	Yes	UCS DR 24X7X40S*
CON-C4PL-C240M5SX	C4PL	Yes	LL 24X7X40S**
CON-USD7L-C240M5SX	USD7L	Yes	LLUCS HW DR 24X7X40S***
CON-OSE-C240M5SX	C4S	Yes	SNTC 8X5X40S

Table 34 Cisco SNTC for UCS Service (PID UCSC-C240-M5SX)

Service SKU	Service Level GSP	On Site?	Description
CON-UCSD6-C240M5SX	UCSD6	Yes	UC SUPP DR 8X5X4OS*
CON-SNCO-C240M5SX	SNCO	Yes	SNTC 8x7xNCDOS****
CON-OS-C240M5SX	CS	Yes	SNTC 8X5XNBDOS
CON-UCSD5-C240M5SX	UCSD5	Yes	UCS DR 8X5XNBDOS*
CON-S2P-C240M5SX	S2P	No	SNTC 24X7X2
CON-S2PL-C240M5SX	S2PL	No	LL 24X7X2**
CON-SNTP-C240M5SX	SNTP	No	SNTC 24X7X4
CON-SNTPL-C240M5SX	SNTPL	No	LL 24X7X4**
CON-SNTE-C240M5SX	SNTE	No	SNTC 8X5X4
CON-SNC-C240M5SX	SNC	No	SNTC 8x7xNCD****
CON-SNT-C240M5SX	SNT	No	SNTC 8X5XNBD
CON-SW-C240M5SX	SW	No	SNTC NO RMA

Note: For PID UCSC-C240-M5S, select Service SKU with CC240M5S suffix (Example: CON-PREM-CC240M5S)

Note: For PID UCSC-C240-M5SN, select Service SKU with C240M5SN suffix (Example: CON-PREM-C240M5SN)

*Includes Drive Retention (see [UCS Drive Retention Service, page 76](#))

**Includes Local Language Support (see [Local Language Technical Support for UCS, page 77](#)) - Only available in China and Japan

***Includes Local Language Support and Drive Retention – Only available in China and Japan

****Available in China Only

Smart Net Total Care for Cisco UCS Onsite Troubleshooting Service

An enhanced offer over traditional Smart Net Total Care which provides onsite-troubleshooting expertise to aid in the diagnostics and isolation of hardware issue within our customers' Cisco Unified Computing System (UCS) environment. It is delivered by a Cisco Certified field engineer (FE) in collaboration with remote TAC engineer and Virtual Internet working Support Engineer (VISE). You can choose a desired service listed in [Table 35](#)

Table 35 SNTC for Cisco UCS Onsite Troubleshooting Service (PID UCSC-C240-M5SX)

Service SKU	Service Level GSP	On Site?	Description
CON-OSPT-C240M5SX	OSPT	Yes	24X7X4OS Trblshtg

Table 35 (continued)SNTC for Cisco UCS Onsite Troubleshooting Service (PID UCSC-C240-M5SX)

CON-OSPTD-C240M5SX	OSPTD	Yes	24X7X40S TrblshtgDR*
CON-OSPTL-C240M5SX	OSPTL	Yes	24X7X40S TrblshtgLL**
CON-OPTLD-C240M5SX	OPTLD	Yes	24X7X40S TrblshtgLLD***

Note: For PID UCSC-C240-M5S, select Service SKU with CC240M5S suffix (Example: CON-PREM-CC240M5S)
For PID UCSC-C240-M5SN, select Service SKU with C240M5SN suffix (Example: CON-PREM-C240M5SN)

*Includes Drive Retention (see [UCS Drive Retention Service, page 76](#))

**Includes Local Language Support (see [Local Language Technical Support for UCS, page 77](#)) - Only available in China and Japan

***Includes Local Language Support and Drive Retention – Only available in China and Japan

Solution Support for UCS

Solution Support includes both Cisco product support and solution-level support, resolving complex issues in multivendor environments, on average, 43% more quickly than product support alone. Solution Support is a critical element in data center administration, to help rapidly resolve any issue encountered, while maintaining performance, reliability, and return on investment.

This service centralizes support across your multivendor Cisco environment for both our products and solution partner products you've deployed in your ecosystem. Whether there is an issue with a Cisco or solution partner product, just call us. Our experts are the primary point of contact and own the case from first call to resolution. For more information please refer to the following url:

<http://www.cisco.com/c/en/us/services/technical/solution-support.html?stickynav=1>

You can choose a desired service listed in [Table 36](#).

Table 36 Solution Support for UCS Service (PID UCSC-C240-M5SX)

Service SKU	Service Level GSP	On Site?	Description
CON-SSC2P-C240M5SX	SSC2P	Yes	SOLN SUPP 24X7X20S
CON-SSC4P-C240M5SX	SSC4P	Yes	SOLN SUPP 24X7X40S
CON-SSC4S-C240M5SX	SSC4S	Yes	SOLN SUPP 8X5X40S
CON-SSCS-C240M5SX	SSCS	Yes	SOLN SUPP 8X5XNBDOS
CON-SSDR7-C240M5SX	SSDR7	Yes	SSPT DR 24X7X40S*
CON-SSDR5-C240M5SX	SSDR5	Yes	SSPT DR 8X5XNBDOS*
CON-SSS2P-C240M5SX	SSS2P	No	SOLN SUPP 24X7X2
CON-SSSNP-C240M5SX	SSSNP	No	SOLN SUPP 24X7X4
CON-SSSNE-C240M5SX	SSSNE	No	SOLN SUPP 8X5X4

Table 36 Solution Support for UCS Service (PID UCSC-C240-M5SX) (continued)

CON-SSSNC-C240M5SX	SSSNC	No	SOLN SUPP NCD**
CON-SSSNT-C240M5SX	SSSNT	No	SOLN SUPP 8X5XNBD

Note: For PID UCSC-C240-M5S, select Service SKU with CC240M5S suffix (Example: CON-PREM-CC240M5S)
For PID UCSC-C240-M5SN, select Service SKU with C240M5SN suffix (Example: CON-PREM-C240M5SN)

*Includes Drive Retention (see [UCS Drive Retention Service, page 76](#))

**Available in China only

Smart Net Total Care for UCS Hardware Only Service

For faster parts replacement than is provided with the standard Cisco Unified Computing System warranty, Cisco offers the Cisco Smart Net Total Care for UCS Hardware Only Service. You can choose from two levels of advanced onsite parts replacement coverage in as little as four hours. Smart Net Total Care for UCS Hardware Only Service provides remote access any time to Cisco support professionals who can determine if a return materials authorization (RMA) is required. You can choose a desired service listed in [Table 37](#)

Table 37 SNTC for UCS Hardware Only Service (PID UCSC-C240-M5SX)

Service SKU	Service Level GSP	On Site?	Description
CON-UCW7-C240M5SX	UCW7	Yes	UCS HW 24X7X40S
CON-UCWD7-C240M5SX	UCWD7	Yes	UCS HW+DR 24X7X40S*
CON-UCW7L-C240M5SX	UCW7L	Yes	LL UCS 24X7X40S**
CON-UWD7L-C240M5SX	UWD7L	Yes	LL UCS DR 24X7X40S***
CON-UCW5-C240M5SX	UCW5	Yes	UCS HW 8X5XNBDOS
CON-UCWD5-C240M5SX	UCWD5	Yes	UCS HW+DR 8X5XNBDOS*

Note: For PID UCSC-C240-M5S, select Service SKU with CC240M5S suffix (Example: CON-PREM-CC240M5S)
For PID UCSC-C240-M5SN, select Service SKU with C240M5SN suffix (Example: CON-PREM-C240M5SN)

*Includes Drive Retention (see [UCS Drive Retention Service, page 76](#))

**Includes Local Language Support (see [Local Language Technical Support for UCS, page 77](#)) - Only available in China and Japan

***Includes Local Language Support and Drive Retention - Only available in China and Japan

Partner Support Service for UCS

Cisco Partner Support Service (PSS) is a Cisco Collaborative Services service offering that is designed for partners to deliver their own branded support and managed services to enterprise

customers. Cisco PSS provides partners with access to Cisco's support infrastructure and assets to help them:

- Expand their service portfolios to support the most complex network environments
- Lower delivery costs
- Deliver services that increase customer loyalty

PSS options enable eligible Cisco partners to develop and consistently deliver high-value technical support that capitalizes on Cisco intellectual assets. This helps partners to realize higher margins and expand their practice.

PSS is available to all Cisco PSS partners.

The two Partner Unified Computing Support Options include:

- Partner Support Service for UCS
- Partner Support Service for UCS Hardware Only

PSS for UCS provides hardware and software support, including triage support for third party software, backed by Cisco technical resources and level three support. You can choose a desired service listed in [Table 38](#).

Table 38 PSS for UCS (PID UCSC-C240-M5SX)

Service SKU	Service Level GSP	On Site?	Description
CON-PSJ8-C240M5SX	PSJ8	Yes	UCS PSS 24X7X2 OS
CON-PSJ7-C240M5SX	PSJ7	Yes	UCS PSS 24X7X4 OS
CON-PSJD7-C240M5SX	PSJD7	Yes	UCS PSS 24X7X4 DR*
CON-PSJ6-C240M5SX	PSJ6	Yes	UCS PSS 8X5X4 OS
CON-PSJD6-C240M5SX	PSJD6	Yes	UCS PSS 8X5X4 DR*
CON-PSJ4-C240M5SX	PSJ4	No	UCS SUPP PSS 24X7X2
CON-PSJ3-C240M5SX	PSJ3	No	UCS SUPP PSS 24X7X4
CON-PSJ2-C240M5SX	PSJ2	No	UCS SUPP PSS 8X5X4
CON-PSJ1-C240M5SX	PSJ1	No	UCS SUPP PSS 8X5XNBD

Note: For PID UCSC-C240-M5S, select Service SKU with C240M5S suffix (Example: CON-PREM-C240M5S)

For PID UCSC-C240-M5SN, select Service SKU with C240M5SN suffix (Example: CON-PREM-C240M5SN)

*Includes Drive Retention (see [UCS Drive Retention Service, page 76](#))

PSS for UCS Hardware Only

PSS for UCS Hardware Only provides customers with replacement parts in as little as two hours and provides remote access any time to Partner Support professionals who can determine if a

return materials authorization (RMA) is required. You can choose a desired service listed in [Table 39](#)

Table 39 PSS for UCS Hardware Only (PID UCSC-C240-M5SX)

Service SKU	Service Level GSP	On Site?	Description
CON-PSW7-C240M5SX	PSW7	Yes	UCS W PSS 24X7X4 OS
CON-PSWD7-C240M5SX	PSWD7	Yes	UCS W PSS 24X7X4 DR*
CON-PSW6-C240M5SX	PSW6	Yes	UCS W PSS 8X5X4 OS
CON-PSWD6-C240M5SX	PSWD6	Yes	UCS W PSS 8X5X4 DR*
CON-PSW4-C240M5SX	PSW4	No	UCS W PL PSS 24X7X2
CON-PSW3-C240M5SX	PSW3	No	UCS W PL PSS 24X7X4
CON-PSW2-C240M5SX	PSW2	No	UCS W PL PSS 8X5X4

Note: For PID UCSC-C240-M5S, select Service SKU with CC240M5S suffix (Example: CON-PREM-CC240M5S)

For PID UCSC-C240-M5SN, select Service SKU with C240M5SN suffix (Example: CON-PREM-C240M5SN)

*Includes Drive Retention (see [UCS Drive Retention Service, page 76](#))

Unified Computing Combined Support Service

Combined Services makes it easier to purchase and manage required services under one contract. SNTC services for UCS help increase the availability of your vital data center infrastructure and realize the most value from your unified computing investment. The more benefits you realize from the Cisco Unified Computing System (Cisco UCS), the more important the technology becomes to your business. These services allow you to:

- Optimize the uptime, performance, and efficiency of your UCS
- Protect your vital business applications by rapidly identifying and addressing issues
- Strengthen in-house expertise through knowledge transfer and mentoring
- Improve operational efficiency by allowing UCS experts to augment your internal staff resources
- Enhance business agility by diagnosing potential issues before they affect your operations,

You can choose a desired service listed in [Table 40](#)

Table 40 Combined Support Service for UCS (PID UCSC-C240-M5SX)

Service SKU	Service Level GSP	On Site?	Description
CON-NCF2P-C240M5SX	NCF2P	Yes	CMB SVC 24X7X2OS
CON-NCF4P-C240M5SX	NCF4P	Yes	CMB SVC 24X7X4OS
CON-NCF4S-C240M5SX	NCF4S	Yes	CMB SVC 8X5X4OS
CON-NCFCS-C240M5SX	NCFCS	Yes	CMB SVC 8X5XNBDOS
CON-NCF2-C240M5SX	NCF2	No	CMB SVC 24X7X2
CON-NCFP-C240M5SX	NCFP	No	CMB SVC 24X7X4
CON-NCFE-C240M5SX	NCFE	No	CMB SVC 8X5X4
CON-NCFT-C240M5SX	NCFT	No	CMB SVC 8X5XNBD
CON-NCFW-C240M5SX	NCFW	No	CMB SVC SW

Note: For PID UCSC-C240-M5S, select Service SKU with CC240M5S suffix (Example: CON-PREM-CC240M5S)

For PID UCSC-C240-M5SN, select Service SKU with C240M5SN suffix (Example: CON-PREM-C240M5SN)

UCS Drive Retention Service

With the Cisco Unified Computing Drive Retention Service, you can obtain a new disk drive in exchange for a faulty drive without returning the faulty drive.

Sophisticated data recovery techniques have made classified, proprietary, and confidential information vulnerable, even on malfunctioning disk drives. The Drive Retention service enables you to retain your drives and ensures that the sensitive data on those drives is not compromised, which reduces the risk of any potential liabilities. This service also enables you to comply with regulatory, local, and federal requirements.

If your company has a need to control confidential, classified, sensitive, or proprietary data, you might want to consider one of the Drive Retention Services listed in the above tables (where available)



NOTE: Cisco does not offer a certified drive destruction service as part of this service.

Local Language Technical Support for UCS

Where available, and subject to an additional fee, local language support for calls on all assigned severity levels may be available for specific product(s) - see tables above.

For a complete listing of available services for Cisco Unified Computing System, see the following

http://www.cisco.com/en/US/products/ps10312/serv_group_home.html

SUPPLEMENTAL MATERIAL

Chassis

An internal view of the C240 M5 chassis with the top cover removed is shown in [Figure 6](#).

Figure 6 C240 M5 SFF With Top Cover Off

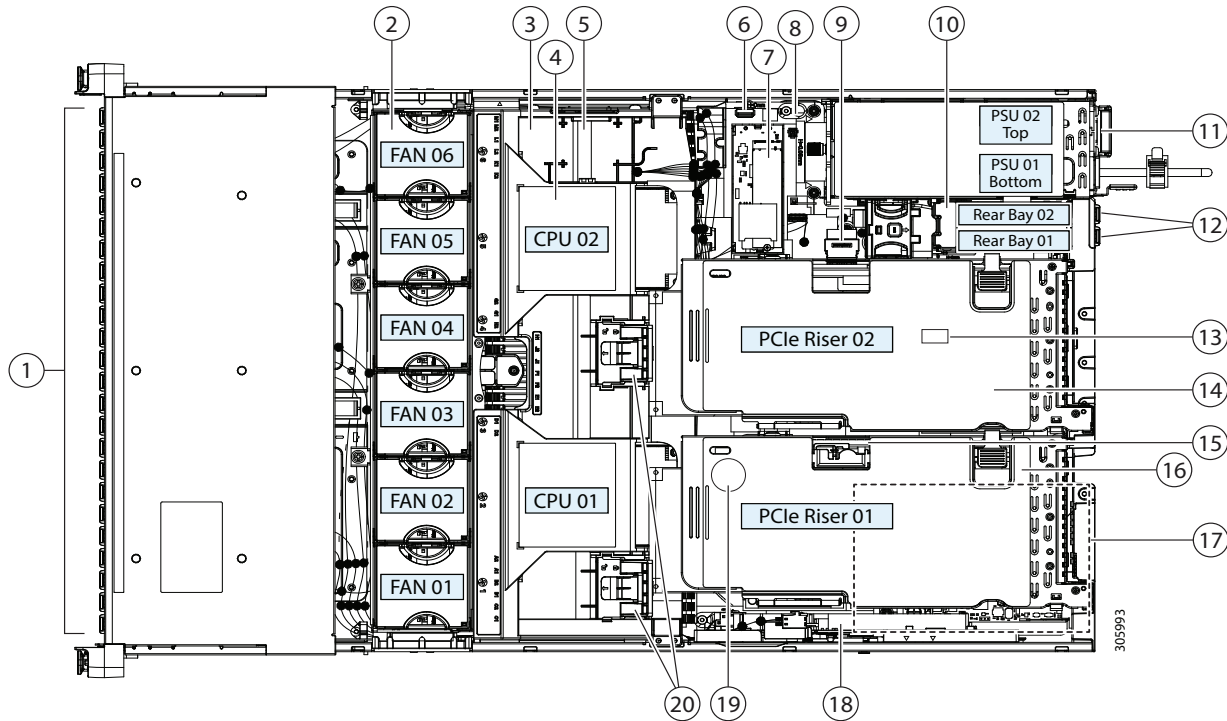

1	Front-facing drive bays.	11	Power supplies (hot-swappable, redundant as 1+1).
2	Cooling Fan modules (six, hot-swappable)	12	Rear 2.5-inch drive bays:
3	DIMM sockets on motherboard (up to 12 per CPU; total 24). Not visible under air baffle in this view.	13	Trusted platform module (TPM) socket on motherboard (not visible in this view)

4	<p>CPUs and heatsinks (one or two). Not visible under air baffle in this view</p>	14	<p>PCIe riser 2 (PCIe slots 4, 5, 6), with the following options:</p> <ul style="list-style-type: none"> ■ 2A—Slots 4 (x8), 5 (x16), and 6 (x16). ■ 2B—With slots 4 (x8), 5 (x16), and 6 (x8); includes one PCIe cable connector for rear NVMe SSDs. ■ 2C—With slots 4 (x8), 5 (x8), and 6 (x8); includes one PCIe cable connector for rear-facing NVMe SSDs, plus one PCIe cable connector for front-facing NVMe SSDs. ■ 2D - With slots 4 (x16), 5 (x8), and 6 (x8); includes one PCIe cable connector for rear NVMe SSDs.
5	<p>Supercap power module (RAID backup battery) mounting location on air baffle</p>	15	<p>Micro-SD card socket on PCIe riser 1</p>
6	<p>Internal, vertical USB 3.0 port on motherboard</p>	16	<p>PCIe riser 1 (PCIe slot 1, 2, 3), with the following options:</p> <ul style="list-style-type: none"> ■ 1A—Slots 1 (x8), 2 (x16), 3 (x8); slot 2 requires CPU2. ■ 1B—Slots 1 (x8), 2 (x8), 3 (x8); all slots supported by CPU1.
7	<p>Mini storage module socket Supports either an SD card carrier with two SD card slots; or an M.2 SSD carrier with two slots for either two M.2 SATA or two M.2 NVMe SSDs.</p>	17	<p>Modular LOM (mLOM) card bay on chassis floor (x16 PCIe lane), not visible in this view</p>
8	<p>Chassis intrusion switch (optional)</p>	18	<p>Cisco modular RAID controller PCIe slot (dedicated slot)</p>
9	<p>PCIe cable connectors for NVMe SSDs, only on these PCIe riser 2 options:</p> <ul style="list-style-type: none"> ■ 2B: One connector for two rear NVMe SSDs ■ 2C: One connector for two rear NVMe SSDs plus one connector for two front-facing NVMe SSDs ■ 2D: One connector for rear NVMe SSDs. (This riser version is available only in the NVMe-optimized server UCSC-C240-M5SN). 	19	<p>RTC battery on motherboard (not visible in this view)</p>
10	<p>Rear-drive backplane assembly</p>	20	<p>Securing clips for GPU cards on air baffle</p>

Block Diagram

Figure 7 C240 M5 Block Diagram

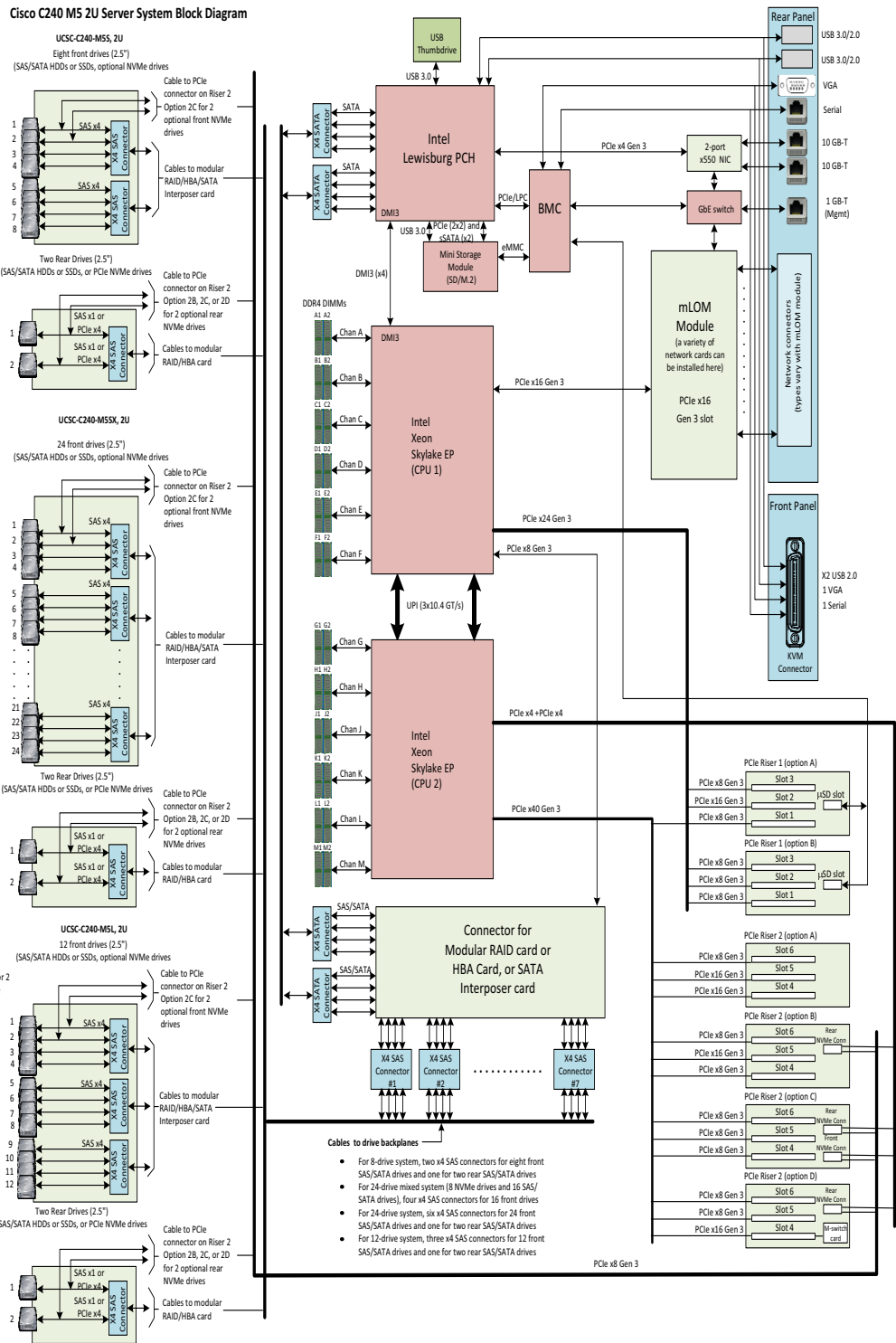

RAID Option ROM (OPROM) Settings

The server contains an Option ROM (OPROM) for the PCIe slots. The server has a finite amount of option ROM with which it can boot up devices. Go into the BIOS and disable the OPROM on the PCIe slots not used for booting so that resources are available for the slots that are used for booting. An example OPROM BIOS screen is shown in *Figure 8*.

Figure 8 Example BIOS Screen for OPROM

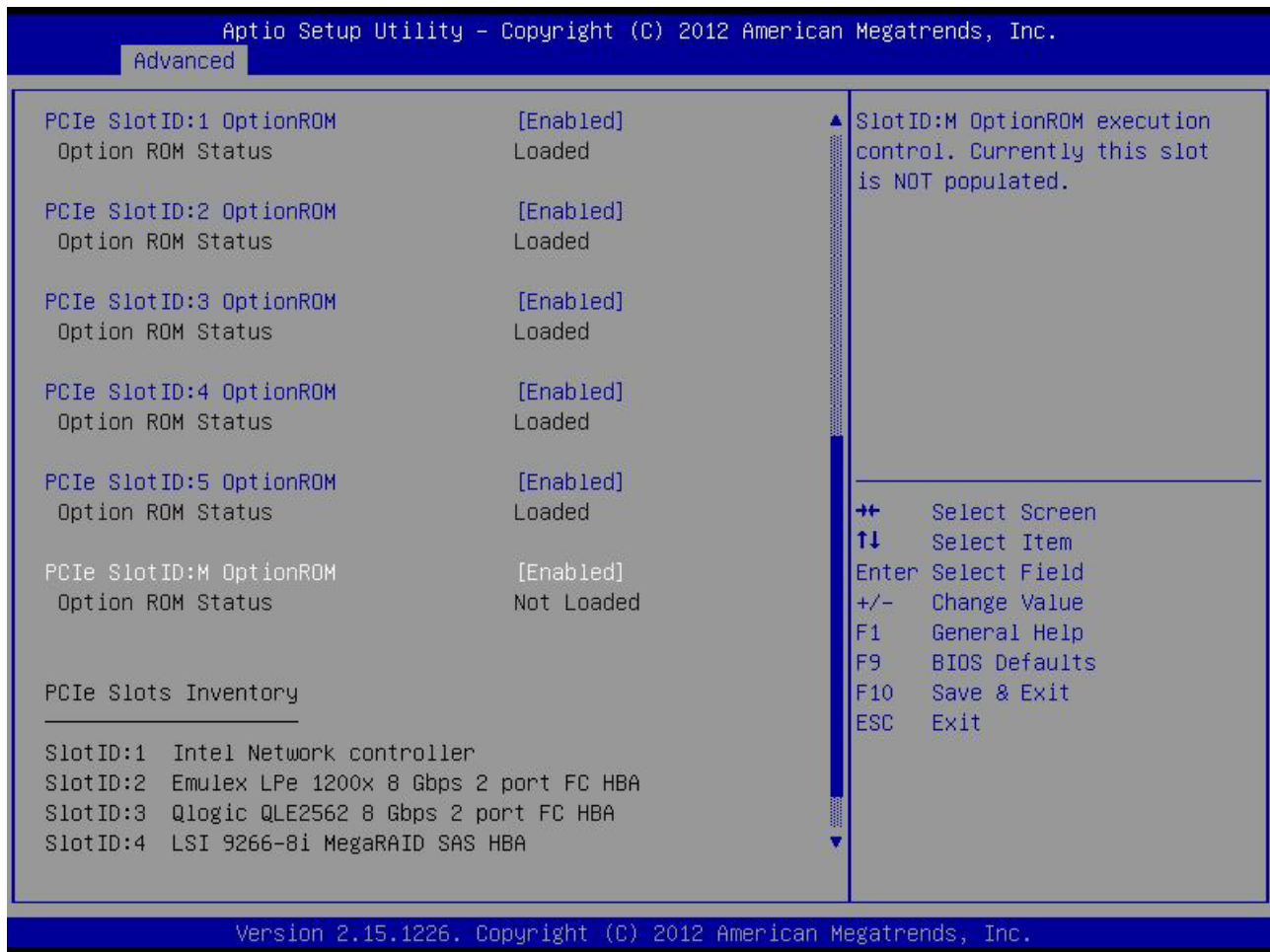

To Create a RAID Group

(1) While the server is booting, wait for the prompt and press function key F2 as shown in [Figure 9](#).

Figure 9 Function Key F2 Prompt

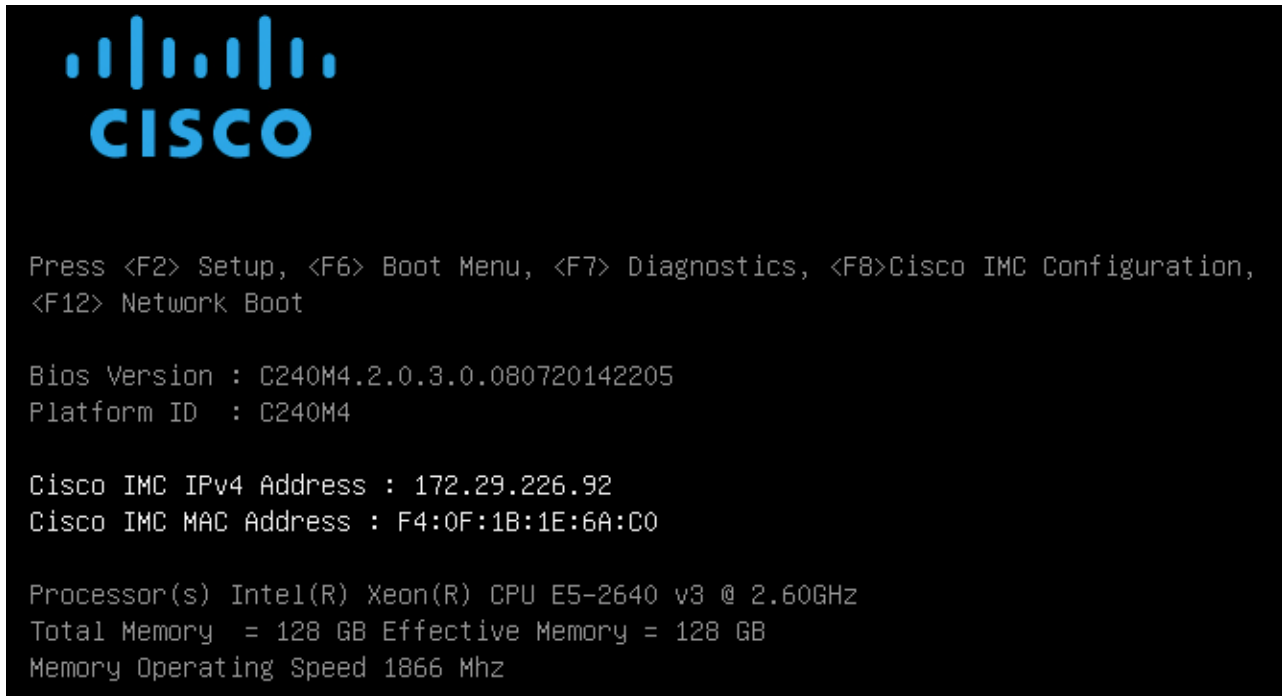

```

CISCO

Press <F2> Setup, <F6> Boot Menu, <F7> Diagnostics, <F8>Cisco IMC Configuration,
<F12> Network Boot

Bios Version : C240M4.2.0.3.0.080720142205
Platform ID  : C240M4

Cisco IMC IPv4 Address : 172.29.226.92
Cisco IMC MAC Address  : F4:0F:1B:1E:6A:C0

Processor(s) Intel(R) Xeon(R) CPU E5-2640 v3 @ 2.60GHz
Total Memory  = 128 GB Effective Memory = 128 GB
Memory Operating Speed 1866 Mhz

```

In a few seconds, you will see the screen that allows you to set up a RAID group for the primary SATA controller (see [Figure 10](#)).

Figure 10 Screen to Configure Primary SATA RAID Group

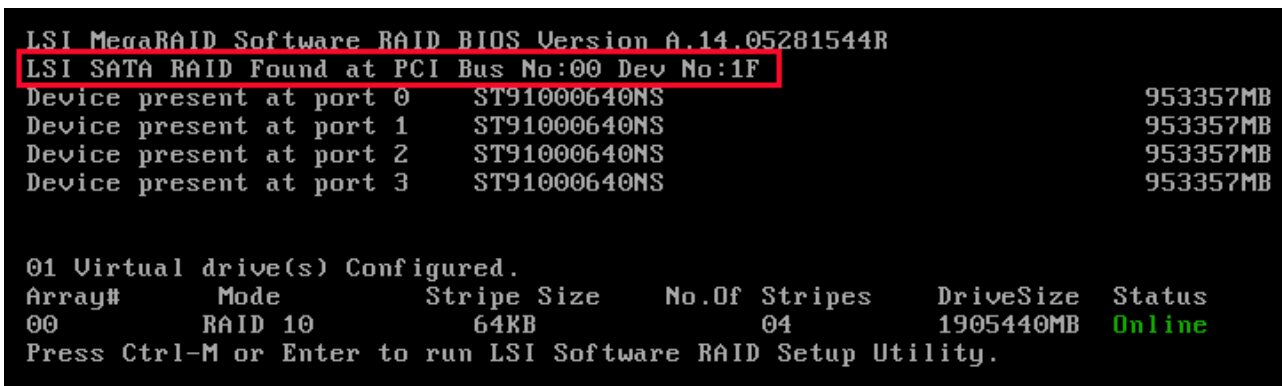

```

LSI MegaRAID Software RAID BIOS Version A.14.05281544R
LSI SATA RAID Found at PCI Bus No:00 Dev No:1F
Device present at port 0      ST91000640NS      953357MB
Device present at port 1      ST91000640NS      953357MB
Device present at port 2      ST91000640NS      953357MB
Device present at port 3      ST91000640NS      953357MB

01 Virtual drive(s) Configured.
Array#      Mode      Stripe Size      No.Of Stripes      DriveSize      Status
00          RAID 10      64KB             04                 1905440MB      Online
Press Ctrl-M or Enter to run LSI Software RAID Setup Utility.

```

(2) Press Ctrl+M to start the RAID group creation process for the primary SATA controller (for drives 1-4, as shown in [Figure 9 on page 82](#)). Or, do nothing and wait for the next screen, which allows you to create a RAID group for the secondary SATA (sSATA) controller see [Figure 11](#)).

Figure 11 Screen to Configure Secondary SATA (sSATA) RAID Group

```

Device present at port 3      ST91000640NS      953357MB

01 Virtual drive(s) Configured.
Array#      Mode      Stripe Size      No.Of Stripes      DriveSize      Status
00          RAID 10      64KB             04                 1905440MB     Online
Press Ctrl-M or Enter to run LSI Software RAID Setup Utility.

LSI MegaRAID Software RAID BIOS Version A.14.05281544R
LSI sSATA RAID Found at PCI Bus No:00 Dev No:11
Device present at port 0      INTEL SSDSC2BA200G3      190270MB
Device present at port 1      INTEL SSDSC2BA200G3      190270MB
Device present at port 2      INTEL SSDSC2BB120G4      113961MB
Device present at port 3      Micron_P400e-MTFDDAK100MAR      94884MB

04 Virtual drive(s) Configured.
Array#      Mode      Stripe Size      No.Of Stripes      DriveSize      Status
00          RAID 0      64KB             01                 189781MB     Online
01          RAID 0      64KB             01                 189781MB     Online
02          RAID 0      64KB             01                 113487MB     Online
03          RAID 0      64KB             01                 94413MB      Online
Press Ctrl-M or Enter to run LSI Software RAID Setup Utility.
    
```

(3) Press Ctrl+M to start the RAID group creation process for the secondary SATA (sSATA) controller (for drives 5-8, as shown in [Figure 9 on page 82](#)).

Riser Card Configuration and Options

The two riser cards are shown in [Figure 12](#).

Figure 12 Riser Card 1 (slots 1, 2, and 3) and Riser Card 2 (slots 4, 5, and 6)

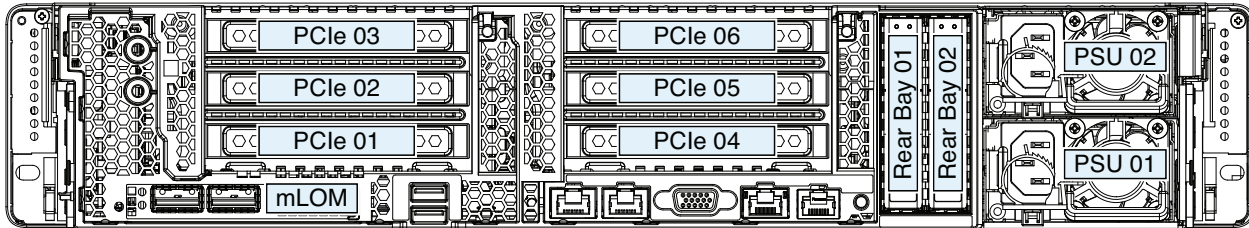

Serial Port Details

The pinout details of the rear RJ-45 serial port connector are shown in [Figure 13](#).

Figure 13 Serial Port (Female RJ-45 Connector) Pinout

Serial Port (RJ-45 Female Connector)

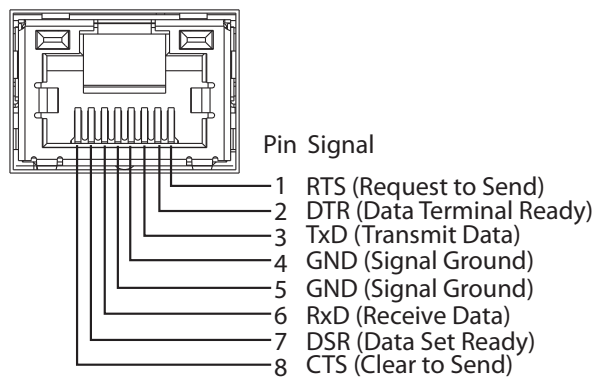

KVM Cable

The KVM cable provides a connection into the server, providing a DB9 serial connector, a VGA connector for a monitor, and dual USB 2.0 ports for a keyboard and mouse. With this cable, you can create a direct connection to the operating system and the BIOS running on the server.

The KVM cable ordering information is listed in [Table 41](#).

Table 41 KVM Cable

Product ID (PID)	PID Description
N20-BKVM=	KVM cable for server console port

Figure 14 KVM Cable

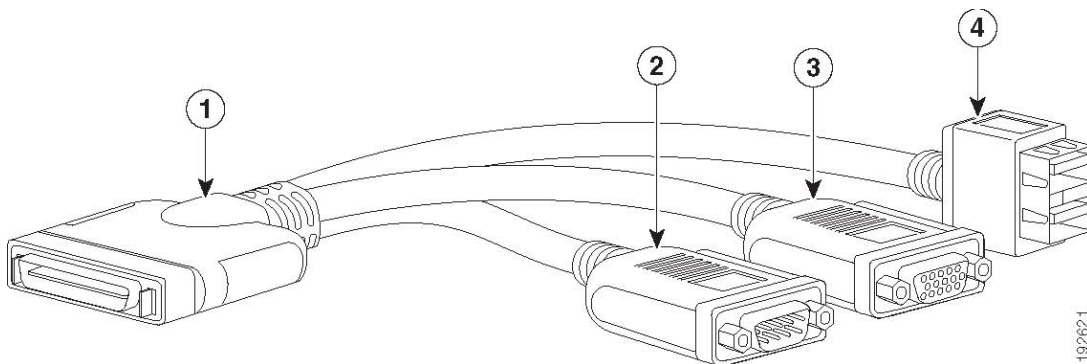

1	Connector (to server front panel)	3	VGA connector (for a monitor)
2	DB-9 serial connector	4	Two-port USB 2.0 connector (for a mouse and keyboard)

SPARE PARTS

This section lists the upgrade and service-related parts for the UCS C240 M5 server. Some of these parts are configured with every server.

Table 42 Spare Parts

Product ID (PID)	PID Description
KVM Cable	
N20-BKVM=	KVM local IO cable for UCS servers console port
CPU Accessories	
UCSC-HS-C240M5=	Heat sink for UCS C240 M5 rack servers 150W CPUs & below
UCSC-HS2-C240M5=	Heat sink for UCS C240 M5 rack servers CPUs above 150W
UCS-CPU-TIM=	Single CPU thermal interface material syringe for M5 server HS seal ¹
UCSX-HSCK=	UCS Processor Heat Sink Cleaning Kit (when replacing a CPU) ²
UCS-CPUAT=	CPU Assembly Tool for M5 Servers
UCS-M5-CPU-CAR=	UCS M5 CPU Carrier
UCSC-FAN-C240M5=	C240 M5 Fan Module (one)
M.2 SATA SSD and Raid controller	
UCS-MSTOR-M2=	M.2 module (holds up to 2 M.2 SATA drives)
UCS-M2-HWRAID =	Cisco Boot optimized M.2 RAID controller (holds up to 2 M.2 SATA SSDs)
UCS-M2-I240GB=	240 GB M.2 SATA SSD
UCS-M2-I480GB=	480 GB M.2 SATA SSD
UCS-M2-240G=	240GB SATA M.2
UCS-M2-480G=	480GB M.2 SATA SSD
UCS-M2-960G=	960GB SATA M.2
RISER CARD	
UCSC-PCI-1-C240M5=	Riser 1. Includes 3 PCIe slots (x8, x16, x8). Slots 1 and 2 controlled with CPU1; slot 3 controlled with CPU2.
UCSC-PCI-1B-240M5=	Riser 1B. Includes 3 PCIe slots (x8, x8, x8). All slots controlled with CPU1.
UCSC-RIS-1-240M5=	Riser 1 3PCIe slots (x8, x16, x8); slot 3 req CPU2, For T4
UCSC-RIS-1B-240M5=	Riser 1B 3PCIe slots (x8, x8, x8); all from CPU1, For T4
UCSC-PCI-2A-240M5=	Riser 2A. Includes 3 PCIe slots (x16, x16, x8) and supports a GPU.

Table 42 Spare Parts (continued)

Product ID (PID)	PID Description
UCSC-PCI-2B-240M5=	Riser 2B. Includes 3 PCIe slots (x8, x16, x8) plus 1 NVMe connector (controls two rear SFF NVMe drives) and supports a GPU.
UCSC-PCI-2C-240M5=	Riser 2C. Includes 3 PCIe slots (x8, x8, x8) plus 2 NVMe connectors (one connector for two front SFF NVMe drives and one connector for two rear SFF NVMe drives).
UCSC-RIS-2A-240M5=	Riser 2A 3PCIe slots (x8, x16, x16) supports GPU, For T4
UCSC-RIS-2B-240M5=	Riser 2B 3PCIe slot(x8, x16, x8) supports GPU+rear NVMe, For T4
UCSC-RIS-2C-240M5=	Riser 2C 3PCIe slots (3 x8) supports front+rear NVMe, For T4
Memory	
UCS-ML-256G8RT-H=	256 GB DDR4-2933MHz LRDIMM/8Rx4/1.2v
UCS-ML-128G4RT-H=	128 GB DDR4-2933MHz LRDIMM/4Rx4 (16Gb)
UCS-ML-X64G4RT-H	64 GB DDR4-2933MHz LRDIMM/4Rx4 (8Gb)
UCS-MR-X64G2RT-H=	64 GB DDR4-2933MHz RDIMM/2Rx4 (16Gb)
UCS-MR-X32G2RT-H=	32GB DDR4-2933MHz RDIMM/2Rx4 (8Gb)
DRIVES	
HDDs	
HDDs (15K RPM)	
UCS-HD300G15K12N=	300 GB 12G SAS 15K RPM SFF HDD
UCS-HD600G15K12N=	600 GB 12G SAS 15K RPM SFF HDD
UCS-HD900G15K12N=	900 GB 12G SAS 15K RPM SFF HDD
HDDs (10K RPM)	
UCS-HD300G10K12N=	300 GB 12G SAS 10K RPM SFF HDD
UCS-HD600G10K12N=	600 GB 12G SAS 10K RPM SFF HDD
UCS-HD12TB10K12N=	1.2 TB 12G SAS 10K RPM SFF HDD
UCS-HD18TB10K4KN ² =	1.8 TB 12G SAS 10K RPM SFF HDD (4K)
UCS-HD24TB10K4KN=	2.4 TB 12G SAS 10K RPM SFF HDD (4K)
HDDs (7.2K RPM)	
UCS-HD1T7K12N=	1 TB 12G SAS 7.2K RPM SFF HDD
UCS-HD2T7K12N=	2 TB 12G SAS 7.2K RPM SFF HDD
UCS-HD1T7K6GAN=	1 TB 6G SATA 7.2K RPM SFF HDD

Table 42 Spare Parts (continued)

Product ID (PID)	PID Description
SAS/SATA SSDs	
Enterprise Performance SSDs (High endurance, supports up to 10X or 3X DDPD (drive writes per day))³	
SAS SSDs	
UCS-SD800GK3X-EP=	800 GB 2.5in Enterprise Performance 12G SAS SSD(3X endurance)
UCS-SD16TK3X-EP=	1.6 TB 2.5in Enterprise Performance 12G SAS SSD(3X endurance)
UCS-SD32TK3X-EP=	3.2 TB 2.5in Enterprise Performance 12G SAS SSD(3X endurance)
SATA SSDs	
UCS-SD480G63X-EP=	480GB 2.5in Enterprise performance 6GSATA SSD(3X endurance) (Intel S4600/S4610)
UCS-SD960G63X-EP=	960GB 2.5in Enterprise performance 6GSATA SSD(3X endurance) (Intel S4600/S4610)
UCS-SD19T63X-EP=	1.9TB 2.5in Enterprise performance 6GSATA SSD(3X endurance) (Intel S4600/S4610)
UCS-SD19TBM3X-EP=	1.9TB 2.5in Enterprise performance 6GSATA SSD(3X endurance)
UCS-SD960GBM3X-EP=	960GB 2.5in Enterprise performance 6GSATA SSD(3X endurance)
UCS-SD480GBM3X-EP=	480GB 2.5in Enterprise Performance 6GSATA SSD(3X endurance)
Enterprise Value SSDs (Low endurance, supports up to 1X DDPD (drive writes per day))⁴	
SAS SSDs	
UCS-SD960GK1X-EV=	960 GB 2.5 inch Enterprise Value 12G SAS SSD
UCS-SD19TK1X-EV=	1.9 TB 2.5 inch Enterprise Value 12G SAS SSD
UCS-SD38TK1X-EV=	3.8 TB 2.5 inch Enterprise Value 12G SAS SSD
UCS-SD76TK1X-EV=	7.6 TB 2.5 inch Enterprise Value 12G SAS SSD
UCS-SD15TK1X-EV=	15.3 TB 2.5 inch Enterprise Value 12G SAS SSD
SATA SSDs	
UCS-SD76TBM1X-EV=	7.6TB 2.5 inch Enterprise Value 6G SATA SSD
UCS-SD38TBM1X-EV=	3.8TB 2.5 inch Enterprise Value 6G SATA SSD
UCS-SD19TBM1X-EV=	1.9TB 2.5 inch Enterprise Value 6G SATA SSD
UCS-SD16TBM1X-EV=	1.6TB 2.5 inch Enterprise Value 6G SATA SSD
UCS-SD960GBM1X-EV=	960GB 2.5 inch Enterprise Value 6G SATA SSD
UCS-SD480GBM1X-EV=	480 GB 2.5 inch Enterprise Value 6G SATA SSD

Table 42 Spare Parts (continued)

Product ID (PID)	PID Description
UCS-SD240GBM1X-EV=	240GB 2.5 inch Enterprise Value 6G SATA SSD
UCS-SD120GM1X-EV=	120 GB 2.5 inch Enterprise Value 6G SATA SSD (Micron 5100/5200/5300)
UCS-SD19T61X-EV=	1.9 TB 2.5 inch Enterprise Value 6G SATA SSD (Samsung PM863A/PM883)
UCS-SD38T61X-EV=	3.8TB 2.5 inch Enterprise Value 6G SATA SSD (Samsung PM863A/PM883)
UCS-SD480G61X-EV=	480GB 2.5 inch Enterprise Value 6G SATA SSD (Intel S4500/S4510)
UCS-SD960G61X-EV=	960GB 2.5 inch Enterprise Value 6G SATA SSD (Intel S4500/S4510)
UCS-SD38T61X-EV=	3.8TB 2.5 inch Enterprise Value 6G SATA SSD (Intel S4500/S4510)
UCS-SD960G6S1X-EV=	960GB 2.5 inch Enterprise Value 6G SATA SSD
UCS-SD19T6S1X-EV=	1.9TB 2.5 inch Enterprise Value 6G SATA SSD
UCS-SD38T6S1X-EV=	3.8TB 2.5 inch Enterprise Value 6G SATA SSD
UCS-SD76T6S1X-EV=	7.6TB 2.5 inch Enterprise Value 6G SATA SSD
Self-Encrypted Drives (SED)⁵	
UCS-HD600G15NK9=	600 GB 12G SAS 15K RPM SFF HDD (SED) FIPS140-2
UCS-HD18T10NK9=	1.8 TB 12G SAS 10K RPM SFF HDD (4K format, SED) FIPS140-2
UCS-HD12T10NK9=	1.2 TB 12G SAS 10K RPM SFF HDD (SED) FIPS140-2
UCS-HD24T10NK9=	2.4 TB 12G SAS 10K RPM SFF HDD (4K) SED FIPS140-2
UCS-SD800GBKNK9=	800GB Enterprise Performance SAS SSD (3X DWPD, SED)
UCS-SD960GBKNK9=	960GB Enterprise Value SAS SSD (1X DWPD, SED)
UCS-SD38TBKNK9=	3.8TB Enterprise Value SAS SSD (1X DWPD, SED)
UCS-SD16TBKNK9=	1.6TB Enterprise performance SAS SSD (3X DWPD, SED)
UCS-SD480GBHTNK9=	480 GB Enterprise Value SAS SSD (1X DWPD, SED) FIPS140-2
UCS-SD38TBHTNK9=	3.8 TB Enterprise value SAS SSD (1X DWPD, SED) FIPS140-2
UCS-SD19TBEM2NK9=	1.9TB Enterprise value SATA SSD (1X, SED)
UCS-SD76TBKNK9=	7.6TB Enterprise value SAS SSD (1 DWPD, SED-FIPS) FIPS140-2
PCIe/NVMe SFF (2.5-inch) drives⁶	
UCSC-NVMEHW-I3200=	Cisco 2.5" U.2 3.2TB Intel P4600 NVMe High Perf. High Endurance
UCSC-NVMEHW-I2TBV=	Cisco 2.5" U.2 2TB Intel P4500 NVMe High Perf. Value Endurance
UCSC-NVMEXPB-I375=	375GB 2.5in Intel Optane NVMe Extreme Performance SSD
UCSC-NVMEXP-I750=	750GB 2.5in Intel Optane NVMe Extreme Perf

Table 42 Spare Parts (continued)



Product ID (PID)	PID Description
UCS-NVMEXP-I400=	400GB 2.5in U.2 Intel P5800X Optane NVMe Extreme Perform SSD
UCS-NVMEXP-I800=	800GB 2.5in U.2 Intel P5800X Optane NVMe Extreme Perform SSD
UCS-NVME4-1920=	1.9TB 2.5in U.2 15mm P5520 Hg Perf Med End NVMe
UCS-NVME4-3840=	3.8TB 2.5in U.2 15mm P5520 Hg Perf Med End NVMe
UCS-NVME4-7680=	7.6TB 2.5in U.2 15mm P5520 Hg Perf Med End NVMe
UCS-NVME4-1536=	15.3TB 2.5in U.2 15mm P5520 Hg Perf Med End NVMe
UCS-NVME4-1600=	1.6TB 2.5in U.2 15mm P5620 Hg Perf Hg End NVMe (3X)
UCS-NVME4-3200=	3.2TB 2.5in U.2 15mm P5620 Hg Perf Hg End NVMe (3X)
UCS-NVME4-6400=	6.4TB 2.5in U.2 15mm P5620 Hg Perf Hg End NVMe (3X)
UCS-NVMEQ-1536=	15.3TB 2.5in U.2 15mm P5316 Hg Perf Low End NVMe
CBL-NVME-C240SFF=	C240 M5 Front NVMe cable (1) SFF
UCSC-RNVME-240M5=	C240 M5 Rear NVMe CBL(1) kit, Rear NVMe CBL, backplane SFF&LFF
UCS-NVMEM6-W3200=	3.2TB 2.5in U.2 WD SN840 NVMe Extreme Perf. High Endurance
UCS-NVMEM6-W7680 =	7.6TB 2.5in U.2 WD SN840 NVMe Extreme Perf. Value Endurance
UCS-NVMEM6-W15300=	15.3TB 2.5in U.2 WD SN840 NVMe Extreme Perf. Value Endurance
RAID Controllers	
UCSC-9400-8E=	Cisco 9400-8E 12G SAS HBA for external JBOD attach
UCSC-RAID-M5HD=	Cisco 12G Modular RAID controller with 4GB cache
 <p>Note: Supercap (UCSC-SCAP-M5=) and cable (CBL-SC-MR12GM5P=) included when RAID card is ordered as a spare</p>	
UCSC-SAS-M5HD	Cisco 12G SAS HBA for up to 26 drives
UCSC-RAID-M5=	Cisco 12G Modular RAID controller with 2GB cache (supports max 16 drives)
 <p>Note: Supercap (UCSC-SCAP-M5=), Cable (CBL-SC-MR12GM5=), (CBL-SC-MR12GM52=) included when RAID card is ordered as a spare</p>	

Table 42 Spare Parts (continued)

Product ID (PID)	PID Description
UCSC-SAS-M5=	Cisco 12G Modular SAS HBA for up to 16 drives
Raid Controller accessories	
UCSC-SCAP-M5=	Super Cap for Cisco 12G Modular RAID controller
CBL-SC-MR12GM5P=	Super Cap cable for UCSC-RAID-M5HD on C240 M5 Servers
CBL-SC-MR12GM5=	Super Cap cable for UCSC-RAID-M5 on C220 M5 Servers
CBL-SC-MR12GM52=	Super Cap cable for UCSC-RAID-M5 on C240 M5 Servers
Modular LAN on Motherboard (mLOM)	
UCSC-MLOM-C100-04=	Cisco UCS VIC 1497 Dual Port 40/100G QSFP28 CNA mLOM
UCSC-MLOM-C25Q-04=	Cisco UCS VIC 1457 Quad Port 10/25G SFP28 mLOM
UCSC-MLOM-C40Q-03=	Cisco UCS VIC 1387 Dual Port 40Gb QSFP+ CNA
UCSC-MLOM-IRJ45=	Intel i350 Quad Port 1GBase-T NIC
Converged Network Adapters (CNAs)	
UCSC-PCIE-C100-04=	Cisco UCS VIC 1495 Dual Port 40/100G QSFP28 CNA PCIe
UCSC-PCIE-C40Q-03=	Cisco UCS VIC 1385 Dual Port 40Gb QSFP+ CNA w/RDMA
UCSC-PCIE-C25Q-04=	Cisco UCS VIC 1455 Quad Port 10/25G SFP28 CNA PCIe
Network Interface Cards (NICs)	
1 Gb NICs	
UCSC-PCIE-IRJ45=	Intel i350 Quad Port 1GBase-T NIC
10 Gb NICs	
N2XX-AIPCI01=	Intel X520 Dual Port 10Gb SFP+ NIC
UCSC-PCIE-ID10GC=	Intel X550-T2 Dual Port 10GBase-T NIC
UCSC-PCIE-ID10GF=	Intel X710-DA2 Dual Port 10Gb SFP+ NIC
UCSC-PCIE-IQ10GF=	Intel X710 Quad Port 10Gb SFP+ NIC
UCSC-PCIE-IQ10GC=	Intel X710 Quad Port 10GBase-T NIC
25 Gb NICs	
UCSC-PCIE-QD25GF=	Qlogic QL41212H Dual Port 25Gb NIC
UCSC-PCIE-ID25GF=	Intel XXV710 Dual Port 25Gb SFP28 NIC
UCSC-P-M4D25GF=	Mellanox MCX4121A-ACAT dual port 10/25G SFP28 NIC
40 Gb NICs	

Table 42 Spare Parts (continued)

Product ID (PID)	PID Description
UCSC-PCIE-QD40GF=	Qlogic QL45412H Dual Port 40Gb NIC
UCSC-PCIE-ID40GF=	Intel XL710 Dual Port 40Gb QSFP+ NIC
100 Gb NICs	
UCSC-PCIE-QS100GF=	Qlogic QLE45611HLCU single port 100G NIC
Host Bus Adapters (HBAs)	
UCSC-PCIE-QD16GF=	Qlogic QLE2692 Dual Port 16G Fibre Channel HBA
UCSC-PCIE-BD16GF=	Emulex LPe31002 Dual Port 16G Fibre Channel HBA
UCSC-PCIE-QD32GF=	Qlogic QLE2742 Dual Port 32G Fibre Channel HBA
UCSC-PCIE-BS32GF=	Emulex LPe32000-M2 Single Port 32G Fibre Channel HBA
UCSC-PCIE-BD32GF=	Emulex LPe32002-M2 Dual Port 32G Fibre Channel HBA
Other	
UCS-P40CBL-C240M5=	C240 M5 NVIDIA P40 Cable / M60
UCS-P100CBL-240M5=	C240 M5 NVIDIA P100 / V100 Cable, RTX, A100
UCS-M10CBL-C240M5=	C240 M5 NVIDIA M10 Cable
PACK-QSFP-SFP=	Packaging for QSFP 40G and SFP 10G
UCS-AMDCBL-C240M5=	C240 M5 AMD 7150X2 Cable
UCSC-BBLKD-S2=	C-Series M5 SFF drive blanking panel (for Rear Slots)
UCSC-PSU-M5BLK=	Power Supply Blanking Panel for M5 servers
SD Cards	
UCS-SD-32G-S=	32 GB SD Card for UCS servers
UCS-SD-64G-S=	64 GB SD Card for UCS servers
UCS-SD-128G=	128GB SD Card for UCS servers
GPU PCIe Cards	
UCSC-GPU-T4-16=	NVIDIA T4 16GB
UCSC-GPU-M10=	NVIDIA M10
UCSC-GPU-A100-80=	TESLA A100, PASSIVE, 300W, 80GB
Power Supply	
UCSC-PSU1-770W=	770W AC power supply for C-Series Servers Platinum

Table 42 Spare Parts (continued)

Product ID (PID)	PID Description
UCSC-PSU1-1050W=	1050W AC power supply for C-Series servers Platinum
UCSC-PSUV2-1050DC=	1050W DC power supply for C-Series servers Platinum
UCSC-PSU1-1600W=	1600W AC power supply for C-Series servers Platinum
UCSC-PSU1-1050ELV =	1050W AC Power Supply C-Series Enhanced Low Line Platinum
Power Cables	
CAB-48DC-40A-8AWG=	C-Series -48VDC PSU Power Cord, 3.5M, 3 Wire, 8AWG, 40A
CAB-N5K6A-NA=	Power Cord, 200/240V 6A, North America
CAB-AC-L620-C13=	AC Power Cord, NEMA L6-20 - C13, 2M/6.5ft
CAB-C13-CBN	CABASY,WIRE,JUMPER CORD, 27" L, C13/C14, 10A/250V
CAB-C13-C14-2M=	CABASY,WIRE,JUMPER CORD, PWR, 2 Meter, C13/C14,10A/250V
CAB-C13-C14-AC=	CORD,PWR,JMP,IEC60320/C14,IEC6 0320/C13, 3.0M
CAB-250V-10A-AR=	Power Cord, 250V, 10A, Argentina
CAB-9K10A-AU=	Power Cord, 250VAC 10A 3112 Plug, Australia
CAB-250V-10A-CN	AC Power Cord - 250V, 10A - PRC
CAB-9K10A-EU=	Power Cord, 250VAC 10A CEE 7/7 Plug, EU
CAB-250V-10A-ID=	Power Cord, SFS, 250V, 10A, India
CAB-250V-10A-IS=	Power Cord, SFS, 250V, 10A, Israel
CAB-9K10A-IT=	Power Cord, 250VAC 10A CEI 23-16/VII Plug, Italy
CAB-9K10A-SW=	Power Cord, 250VAC 10A MP232 Plug, Switzerland
CAB-9K10A-UK=	Power Cord, 250VAC 10A BS1363 Plug (13 A fuse), UK
CAB-9K12A-NA=	Power Cord, 125VAC 13A NEMA 5-15 Plug, North America
CAB-250V-10A-BR=	Power Cord - 250V, 10A - Brazil
CAB-C13-C14-2M-JP=	Power Cord C13-C14, 2M/6.5ft Japan PSE mark
CAB-9K10A-KOR=	Power Cord, 125VAC 13A KSC8305 Plug, Korea
CAB-ACTW=	AC Power Cord (Taiwan), C13, EL 302, 2.3M
CAB-JPN-3PIN	Japan, 90-125VAC 12A NEMA 5-15 Plug, 2.4m
CAB-C13-C14-IN	Power Cord Jumper,C13-C14 Connectors,1.4 Meter Length, India
CAB-C13-C14-3M-IN	Power Cord Jumper, C13-C14 Connectors, 3 Meter Length, India
CMA	

Table 42 Spare Parts (continued)

Product ID (PID)	PID Description
UCSC-CMA-M5=	Reversible CMA for C240 M4 and M5 rack servers
USB Drive	
UCS-USBFLSHB-16GB=	UCS Servers 16 GB Flash USB Drive (optional)
TPM	
UCSX-TPM2-001=	Trusted Platform Module 1.2 for UCS Servers
UCSX-TPM2-002=	Trusted Platform Module 2.0 for UCS servers
UCSC-INT-SW01=	C240 M5 and C240 M5 Chassis Intrusion Switch
Bezel	
UCSC-BZL-C240M5=	C240 M5 Security Bezel
Software/Firmware	
IMC Supervisor	
CIMC-SUP-BASE-K9=	IMC Supervisor One-time Site Installation License
CIMC-SUP-B01=	IMC Supervisor-Branch Mgt SW for C-Series & E-Series up to 100 Svrs
CIMC-SUP-B02=	IMC Supervisor- Branch Mgt SW for C & E-Series up to 250 Svrs
CIMC-SUP-B10=	IMC Supervisor- Branch Mgt SW for C & E-Series up to 1K Svrs
CIMC-SUP-B25=	IMC Supervisor Branch Mgt SW for C & E-Series 25 Svrs
CIMC-SUP-A01=	IMC Supervisor Adv-Branch Mgt SW for C & E-Series 100 Svrs
CIMC-SUP-A02=	IMC Supervisor Adv-Branch Mgt SW for C & E-Series 250 Svrs
CIMC-SUP-A10=	IMC Supervisor Adv-Branch Mgt SW for C & E-Series 1000 Svrs
CIMC-SUP-A25=	IMC Supervisor Adv-Branch Mgt SW for C & E-Series 250 Svrs
EVAL-CIMC-SUP=	EVAL: IMC Supervisor-Branch Mgt SW for C/E-Series - 50 Svrs
EVAL-CIMC-SUP-BAS=	EVAL: IMC Supervisor One-time Site Installation License
UCS Multi-Domain Manager	
UCS-MDMGR-1S=	UCS Central Per Server License NOTE: IF you must order quantity greater than 1 of UCS-MDMGR-1S, you need to reference the UCS Central Per Server Data Sheet to order the standalone PIDs: UCS-MDMGR-LIC= or UCS-MDMGR-1DMN=
Red Hat	
RHEL-2S2V-1A=	Red Hat Enterprise Linux (1-2 CPU,1-2 VN); 1-Yr Support Req
RHEL-2S2V-3A=	Red Hat Enterprise Linux (1-2 CPU,1-2 VN); 3-Yr Support Req

Table 42 Spare Parts (continued)

Product ID (PID)	PID Description
RHEL-2S2V-1S=	Red Hat Enterprise Linux (1-2 CPU,1-2 VN); Prem 1-Yr SnS
RHEL-2S2V-3S=	Red Hat Enterprise Linux (1-2 CPU,1-2 VN); Prem 3-Yr SnS
RHEL-2S-HA-1S=	RHEL High Availability (1-2 CPU); Premium 1-yr SnS
RHEL-2S-HA-3S=	RHEL High Availability (1-2 CPU); Premium 3-yr SnS
RHEL-2S-RS-1S=	RHEL Resilient Storage (1-2 CPU); Premium 1-yr SnS
RHEL-2S-RS-3S=	RHEL Resilient Storage (1-2 CPU); Premium 3-yr SnS
RHEL-2S2V-5A=	Red Hat Enterprise Linux (1-2 CPU,1-2 VN); 5-Yr Support Req
RHEL-2S-HA-1A=	RHEL High Availability (1-2 CPU); 1-Yr Support Reqd
RHEL-2S-HA-3A=	RHEL High Availability (1-2 CPU); 3-Yr Support Reqd
RHEL-2S-HA-5A=	RHEL High Availability (1-2 CPU); 5-Yr Support Reqd
RHEL-2S-RS-1A=	RHEL Resilient Storage (1-2 CPU); Premium 1-yr SnS Reqd
RHEL-2S-RS-3A=	RHEL Resilient Storage (1-2 CPU); Premium 3-yr SnS Reqd
RHEL-2S-RS-5A=	RHEL Resilient Storage (1-2 CPU); Premium 5-yr SnS Reqd
Red Hat SAP	
RHEL-SAP-2S2V-1S=	RHEL for SAP Apps (1-2 CPU, 1-2 VN); Prem 1-Yr SnS Reqd
RHEL-SAP-2S2V-3S=	RHEL for SAP Apps (1-2 CPU, 1-2 VN); Prem 3-Yr SnS Reqd
RHEL-SAPSP-3S=	RHEL SAP Solutions Premium - License with 3 Years of SnS
RHEL-SAPSS-3S=	RHEL SAP Solutions Standard - License with 3 Years of SnS
SLES and SAP	
SLES-SAP-2S2V-1A=	SLES for SAP Apps (1-2 CPU, 1-2 VM); 1-Yr Support Reqd
SLES-SAP-2SUV-1A=	SLES for SAP Apps (1-2 CPU, Unl VM); 1-Yr Support Reqd
SLES-SAP-2S2V-3A=	SLES for SAP Apps (1-2 CPU, 1-2 VM); 3-Yr Support Reqd
SLES-SAP-2SUV-3A=	SLES for SAP Apps (1-2 CPU, Unl VM); 3-Yr Support Reqd
SLES-SAP-2S2V-5A=	SLES for SAP Apps (1-2 CPU, 1-2 VM); 5-Yr Support Reqd
SLES-SAP-2SUV-5A=	SLES for SAP Apps (1-2 CPU, Unl VM); 5-Yr Support Reqd
SLES-SAP-2S2V-1S=	SLES for SAP Apps (1-2 CPU, 1-2 VM); Priority 1-Yr SnS
SLES-SAP-2SUV-1S=	SLES for SAP Apps (1-2 CPU, Unl VM); Priority 1-Yr SnS
SLES-SAP-2S2V-3S=	SLES for SAP Apps (1-2 CPU, 1-2 VM); Priority 3-Yr SnS
SLES-SAP-2SUV-3S=	SLES for SAP Apps (1-2 CPU, Unl VM); Priority 3-Yr SnS

Table 42 Spare Parts (continued)

Product ID (PID)	PID Description
SLES-SAP-2S2V-5S=	SLES for SAP Apps (1-2 CPU, 1-2 VM); Priority 5-Yr SnS
SLES-SAP-2SUV-5S=	SLES for SAP Apps (1-2 CPU, Unl VM); Priority 5-Yr SnS
SUSE	
SLES-2S2V-1A=	SUSE Linux Enterprise Svr (1-2 CPU,1-2 VM); 1-Yr Support Req
SLES-2SUV-1A=	SUSE Linux Enterprise Svr (1-2 CPU,Unl VM); 1-Yr Support Req
SLES-2S2V-3A=	SUSE Linux Enterprise Svr (1-2 CPU,1-2 VM); 3-Yr Support Req
SLES-2SUV-3A=	SUSE Linux Enterprise Svr (1-2 CPU,Unl VM); 3-Yr Support Req
SLES-2S2V-5A=	SUSE Linux Enterprise Svr (1-2 CPU,1-2 VM); 5-Yr Support Req
SLES-2SUV-5A=	SUSE Linux Enterprise Svr (1-2 CPU,Unl VM); 5-Yr Support Req
SLES-2S2V-1S=	SUSE Linux Enterprise Svr (1-2 CPU,1-2 VM); Prio 1-Yr SnS
SLES-2SUV-1S=	SUSE Linux Enterprise Svr (1-2 CPU,Unl VM); Prio 1-Yr SnS
SLES-2S2V-3S=	SUSE Linux Enterprise Svr (1-2 CPU,1-2 VM); Prio 3-Yr SnS
SLES-2SUV-3S=	SUSE Linux Enterprise Svr (1-2 CPU,Unl VM); Prio 3-Yr SnS
SLES-2S2V-5S=	SUSE Linux Enterprise Svr (1-2 CPU,1-2 VM); Prio 5-Yr SnS
SLES-2SUV-5S=	SUSE Linux Enterprise Svr (1-2 CPU,Unl VM); Prio 5-Yr SnS
SLES-2S-HA-1S=	SUSE Linux High Availability Ext (1-2 CPU); 1yr SnS
SLES-2S-HA-3S=	SUSE Linux High Availability Ext (1-2 CPU); 3yr SnS
SLES-2S-HA-5S=	SUSE Linux High Availability Ext (1-2 CPU); 5yr SnS
SLES-2S-GC-1S=	SUSE Linux GEO Clustering for HA (1-2 CPU); 1yr Sns
SLES-2S-GC-3S=	SUSE Linux GEO Clustering for HA (1-2 CPU); 3yr SnS
SLES-2S-GC-5S=	SUSE Linux GEO Clustering for HA (1-2 CPU); 5yr SnS
SLES-2S-LP-1S=	SUSE Linux Live Patching Add-on (1-2 CPU); 1yr SnS Required
SLES-2S-LP-3S=	SUSE Linux Live Patching Add-on (1-2 CPU); 3yr SnS Required
Microsoft	
MSWS-19-DC16C=	Windows Server 2019 Data Center (16 Cores/Unlimited VMs)
MSWS-19-DC16C-NS=	Windows Server 2019 DC (16 Cores/Unlim VMs) - No Cisco SVC
MSWS-19-ST16C=	Windows Server 2019 Standard (16 Cores/2 VMs)
MSWS-19-ST16C-NS=	Windows Server 2019 Standard (16 Cores/2 VMs) - No Cisco SVC
MSWS-22-ST16C=	Windows Server 2022 Standard (16 Cores/2 VMs)

Table 42 Spare Parts (continued)

Product ID (PID)	PID Description
MSWS-22-ST16C-NS=	Windows Server 2022 Standard (16 Cores/2 VMs) - No Cisco SVC
MSWS-22-DC16C=	Windows Server 2022 Data Center (16 Cores/Unlimited VMs)
MSWS-22-DC16C-NS=	Windows Server 2022 DC (16 Cores/Unlim VMs) - No Cisco SVC

Notes:

1. This part is included with the purchase of option or spare CPU or CPU processor kits.
2. Operating Systems supported on 4k sector size drives are as follows:
 - Windows: Win2012, Win2012R2 and Win2016
 - Linux: RHEL 6.5/6.6/6.7/7.0/7.2/7.3 SLES 11 SP3 and SLES 12
 - VMware ESXI 6.5 and later is Needed for 512E drive support; VMware ESXI 6.7 and later is Needed for 4KN drive support.
 - UEFI Mode must be used when booting from 4K sector size drives, legacy mode is Not supported.
 - Ensure that 4K sector size and 512 byte sector size drives are Not mixed in the same RAID volume.
3. Targeted for write centric IO applications. Supports endurance of 10 or 3 DWPD (drive writes per day). Target applications are caching, online transaction processing (OLTP), data warehousing, and virtual desktop infrastructure (VDI).
4. Targeted for read centric IO applications. Supports endurance of 1 DWPD (drive write per day). Target applications are boot, streaming media, and collaboration.
5. For all self-encrypting drives (SED), standalone Management (CIMC) and UCSM is supported for configuring and managing local keys. SED drives can be managed with local and remote key management (third-party key management).
6. If you choose one or two front-facing PCIe SSD or NVMe drives, drive slots 1 and 2 at the front of the chassis are reserved for these drives (see [Figure 2 on page 4](#) for drive slot numbering).

Memory Support for CPU Classes and CPU Modes

For 2nd Generation Intel® Xeon® Scalable Processors:

- DIMMs and PMem are supported
- CPU PIDs ending in “M” support up to a limit of 2048 GB per CPU
- CPU PIDs ending in “L” support up to a limit of 4608 GB per CPU
- All other CPU PIDs support up to a limit of 1024 GB per CPU
- For the App Direct Mode, both PMem and DIMM capacities count towards the CPU capacity limit
- For the Memory Mode and Mixed Mode only the PMem capacity counts towards the CPU capacity limit

For Configurations Using Only DIMMs

- CPU PIDs ending in “M” support DIMM capacities up to 1536 GB per CPU (using 12 x 128 GB DIMMs) and DIMM capacities up to 2048 GB per CPU (using 8 x 256 GB DIMMs).
- CPU PIDs ending in “L” support DIMM capacities up to 1536 GB per CPU (using 12 x 128 GB DIMMs) and DIMM capacities up to 3072 GB per CPU (using 12 x 256 GB DIMMs). The 4608 GB limit cannot be reached with these capacity DIMMs.
- CPU PIDs not ending in “L” or “M” support DIMM capacities up to 1024 GB per CPU (using 8 x 128 GB DIMMs or 4 x 256 GB DIMMs).

For Configurations Using DIMMs and PMem in App Direct Mode

- CPU PIDs ending in “M” support capacities up to 1792 GB per CPU (using 6 x 128 GB DIMMs and 2 x 512 GB PMem or 4 x 256 GB PMem) or up to 2048 GB per CPU (using 6 x 256 GB DIMMs and 2 x 256 GB PMem or 6 x 256 GB DIMMs and 4 x 128 GB PMem)
- CPU PIDs ending in “L” support capacities up to 3840 GB per CPU (using 6 x 128 GB DIMMs and 6 x 512 GB PMem) or up to 4608 GB per CPU (using 6 x 256 GB DIMMs and 6 x 512 GB PMem)
- CPU PIDs not ending in “L” or “M” support capacities up to 1024 GB per CPU (using 6 x 128 GB DIMMs and 2 x 128 GB PMem).

For Configurations Using DIMMs and PMem in Memory or Mixed Mode



NOTE: For Memory and Mixed Modes, DIMMs are used as cache and do not factor into CPU capacity.

- CPU PIDs ending in “M” support capacities up to 2048 GB per CPU using:
 - 6 x 128 GB DIMMs as cache and 4 x 512 GB PMem as memory, or
 - 6x 256 GB DIMMs as cache and 4 x 512 GB PMem as memory
- CPU PIDs ending in “L” support capacities up to 3072 GB using:
 - 6 x 128 GB DIMMs as cache and 6 x 512 GB PMem as memory, or

- 6 x 256 GB DIMMs as cache and 6 x 512 GB PMem as memory

The allowable 4608 limit for PMem capacity is not reached in this case.

- CPU PIDs not ending in “L” or “M” support capacities up to 1024 GB per CPU using:
 - 6 x 128 GB DIMMs as cache and 2 x 512 GB PMem as memory, or
 - 6 x 256 GB DIMMs as cache and 2 x 512 GB PMem as memory

For Intel® Xeon® Scalable Processors:

- DIMMs are supported; PMem are not supported
- CPU PIDs ending in “M” support DIMM capacities up to 1536 GB per CPU (using 12 x 128 GB DIMMs).
- All other CPU PIDs support DIMM capacities up to 768 GB per CPU (using 6 x 128 GB DIMMs or 12 x 64 GB DIMMs)

UPGRADING or REPLACING CPUs



NOTE: Before servicing any CPU, do the following:

- Decommission and power off the server.
- Slide the C240 M5 SFF server out from the rack.
- Remove the top cover.

To replace an existing CPU, follow these steps:

(1) Have the following tools and materials available for the procedure:

- T-30 Torx driver—Supplied with replacement CPU.
- #1 flat-head screwdriver—Supplied with replacement CPU.
- CPU assembly tool—Supplied with replacement CPU. Can be ordered separately as Cisco PID UCS-CPUAT=.
- Heatsink cleaning kit—Supplied with replacement CPU. Can be ordered separately as Cisco PID UCSX-HSCK=.
- Thermal interface material (TIM)—Syringe supplied with replacement CPU. Can be ordered separately as Cisco PID UCS-CPU-TIM=.

(2) Order the appropriate replacement CPU from [Table 4 on page 15](#)

(3) Carefully remove and replace the CPU and heatsink in accordance with the instructions found in “Cisco UCS C240 M5 Server Installation and Service Guide,” found at:

https://www.cisco.com/c/en/us/td/docs/unified_computing/ucs/c/hw/C240M5/install/C240M5/C240M5_chapter_010.html#concept_bfk_kwp_hz.

To add a new CPU, follow these steps:

(1) Have the following tools and materials available for the procedure:

- T-30 Torx driver—Supplied with new CPU.
- #1 flat-head screwdriver—Supplied with new CPU
- CPU assembly tool—Supplied with new CPU. Can be ordered separately as Cisco PID UCS-CPUAT=
- Thermal interface material (TIM)—Syringe supplied with replacement CPU. Can be ordered separately as Cisco PID UCS-CPU-TIM=

(2) Order the appropriate new CPU from [Table 4 on page 15](#)

(3) Order one heat sink for each new CPU. Order PID UCSC-HS-C240M5= for CPUs that dissipate 150 W or less. Order PID UCSC-HS2-C240M5= for CPUs that dissipate more than 150 W.

(4) Carefully install the CPU and heatsink in accordance with the instructions found in “Cisco UCS C240 M5 Server Installation and Service Guide,” found at:

https://www.cisco.com/c/en/us/td/docs/unified_computing/ucs/c/hw/C240M5/install/C240M5/C240M5_chapter_010.html#concept_bfk_kwp_hz

UPGRADING or REPLACING MEMORY



NOTE: Before servicing any DIMM or PMem, do the following:

- Decommission and power off the server.
- Remove the top cover from the server
- Slide the server out the front of the chassis.

To add or replace DIMMs or PMem, follow these steps:

(1) Order new DIMMs or PMem as needed from [Table 5 on page 22](#).

(2) Open both connector latches and remove and replace the DIMM/PMem as needed.

Figure 15 Replacing Memory

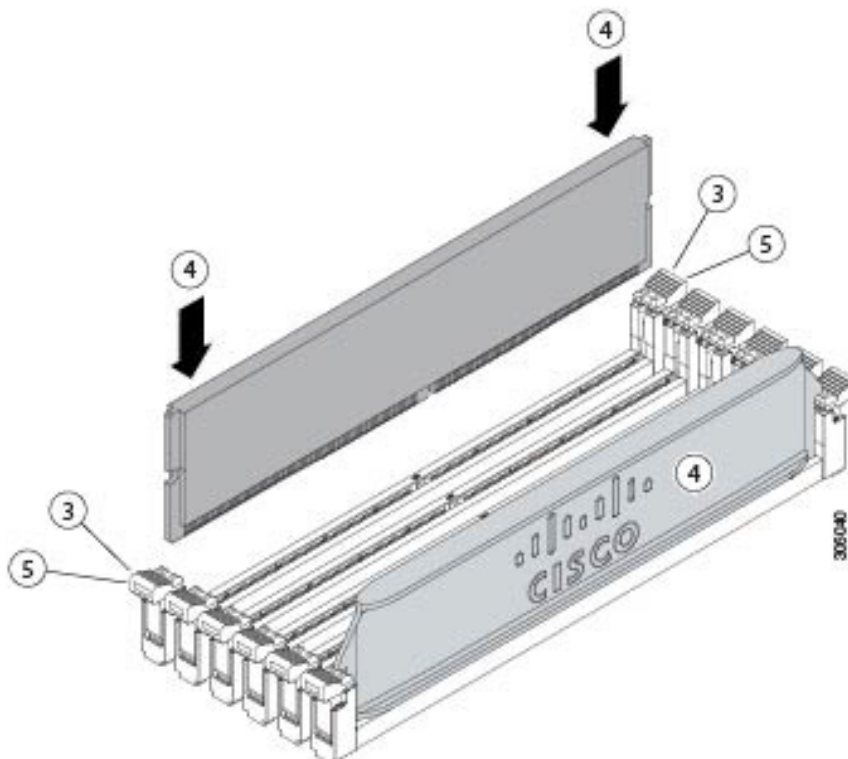

- (3) Press evenly on both ends of the DIMM/PMem until it clicks into place in its slot.



NOTE: Ensure that the notch in the DIMM/PMem aligns with the slot. If the notch is misaligned, it is possible to damage the DIMM/PMem, the slot, or both.

- (4) Press the connector latches inward slightly to seat them fully.

For additional details on replacing or upgrading DIMMs and PMem, see “Cisco UCS C240 M5 Server Installation and Service Guide,” found at these links:

https://www.cisco.com/c/en/us/td/docs/unified_computing/ucs/c/hw/C240M5/install/C240M5/C240M5_chapter_010.html#concept_c53_tbp_hz

https://www.cisco.com/c/en/us/td/docs/unified_computing/ucs/c/hw/C240M5/install/C240M5/C240M5_chapter_010.html#concept_b1k_mbt_tgb

DISCONTINUED EOL PRODUCTS

Below is the list of parts were previously available for this product and are no longer sold. Please refer to the EOL Bulletin Links via the [Table 43](#) below to determine if still supported.

Table 43 EOL Products

EOS option PID	Description	EOL bulletin link
DRIVES		
HDDs		
UCS-HD300G10NK9	300GB 12G SAS 10K RPM SFF HDD (SED)	https://www.cisco.com/c/en/us/products/collateral/servers-unified-computing/ucs-c-series-rack-servers/eos-eol-notice-c51-740779.html
Enterprise Value SSDs		
UCS-SD16T61X-EV	1.6TB 2.5 inch Enterprise Value 6G SATA SSD	https://www.cisco.com/c/en/us/products/collateral/servers-unified-computing/ucs-c-series-rack-servers/eos-eol-notice-c51-741895.html
UCS-SD480G61X-EV	480 GB 2.5 inch Enterprise Value 6G SATA SSD	https://www.cisco.com/c/en/us/products/collateral/servers-unified-computing/ucs-c-series-rack-servers/eos-eol-notice-c51-741644.html
UCS-SD240G61X-EV	240GB 2.5 inch Enterprise Value 6G SATA SSD	https://www.cisco.com/c/en/us/products/collateral/servers-unified-computing/ucs-b-series-blade-servers/eos-eol-notice-c51-742066.html
UCS-SD150G61X-EV	150 GB 2.5 inch Enterprise Value 6G SATA SSD (Intel S3520)	https://www.cisco.com/c/en/us/products/collateral/servers-unified-computing/ucs-b-series-blade-servers/eos-eol-notice-c51-742066.html
UCS-SD240GBE1NK9	240GB Enterprise Value SSD (SATA) (1X DWPD, SED)	https://www.cisco.com/c/en/us/products/collateral/servers-unified-computing/ucs-b-series-blade-servers/eos-eol-notice-c51-742066.html
UCS-SD960GBHTNK9	960 GB Enterprise value SAS SSD (1X DWPD, SED) FIPS140-2	https://www.cisco.com/c/en/us/products/collateral/servers-unified-computing/ucs-c-series-rack-servers/eos-eol-notice-c51-743832.html
UCS-SD960G121X-EV	960GB 2.5 inch Enterprise Value 12G SAS SSD	https://www.cisco.com/c/en/us/products/collateral/hyperconverged-infrastructure/hyperflex-hx-series/eos-eol-notice-c51-2451489.html
UCS-SD960GH61X-EV	960 GB 2.5 inch Enterprise Value 12G SAS SSD	https://www.cisco.com/c/en/us/products/collateral/hyperconverged-infrastructure/hyperflex-hx-series/eos-eol-notice-c51-2451489.html
SEDs		

Table 43 EOL Products

EOS option PID	Description	EOL bulletin link
UCS-SD800GBENK9	800GB Enterprise performance SAS SSD (10X DWPD, SED)	https://www.cisco.com/c/en/us/products/collateral/servers-unified-computing/ucs-c-series-rack-servers/eos-eol-notice-c51-740779 .
UCS-SD480GBHTNK9	480GB Enterprise Value SAS SSD (1X DWPD, SED) FIPS140-2	https://www.cisco.com/c/en/us/products/collateral/servers-unified-computing/ucs-c-series-rack-servers/eos-eol-notice-c51-742823.html
UCS-SD38TBHTNK9	3.8TB Enterprise value SAS SSD (1X DWPD, SED) FIPS140-2	https://www.cisco.com/c/en/us/products/collateral/servers-unified-computing/ucs-c-series-rack-servers/eos-eol-notice-c51-742823.html
UCS-SD480GH61X-EV	480 GB 2.5 inch Enterprise Value 12G SAS SSD	https://www.cisco.com/c/en/us/products/collateral/servers-unified-computing/ucs-c-series-rack-servers/eos-eol-notice-c51-743832.html
UCS-SD480G2HNK9	480GB Enterprise value SAS SSD (1X DWPD, SED) FIPS140-2	https://www.cisco.com/c/en/us/products/collateral/servers-unified-computing/ucs-c-series-rack-servers/eos-eol-notice-c51-743832.html
UCS-SD38TBE1NK9	3.8 TB Enterprise value SATA SSD (1X DWPD, SED) Non FIPS	https://www.cisco.com/c/en/us/products/collateral/servers-unified-computing/ucs-c-series-rack-servers/eos-eol-notice-c51-744204.html
UCS-SD38TH61X-EV	3.8 TB 2.5 inch Enterprise Value 12G SAS SSD	https://www.cisco.com/c/en/us/products/collateral/servers-unified-computing/ucs-c-series-rack-servers/eos-eol-notice-c51-743832.html
UCS-SD19TB121X-EV	1.9 TB 2.5 inch Enterprise Value 12G SAS SSD (Toshiba PM4)	https://www.cisco.com/c/en/us/products/collateral/hyperconverged-infrastructure/hyperflex-hx-series/eos-eol-notice-c51-2451489.html
UCS-SD38TB121X-EV	3.8TB 2.5 inch Enterprise Value 12G SAS SSD	https://www.cisco.com/c/en/us/products/collateral/hyperconverged-infrastructure/hyperflex-hx-series/eos-eol-notice-c51-2451489.html
UCS-SD38T2HTNK9	3.8 TB Enterprise value 12G SAS SSD (1X DWPD, SED) FIPS140-2	https://www.cisco.com/c/en/us/products/collateral/hyperconverged-infrastructure/hyperflex-hx-series/eos-eol-notice-c51-2451489.html
UCS-SD480G121X-EV	480 GB 2.5 inch Enterprise Value 12G SAS SSD	https://www.cisco.com/c/en/us/products/collateral/hyperconverged-infrastructure/hyperflex-hx-series/eos-eol-notice-c51-2451489.html
UCS-SD16TM1X-EV	1.6TB 2.5in Enter Value 6G SATA Micron G1 SSD	https://www.cisco.com/c/en/us/products/collateral/servers-unified-computing/ucs-c-series-rack-servers/unified-computing-accessories-eol.html
UCS-SD38TM1X-EV	3.8TB 2.5in Enter Value 6G SATA Micron G1 SSD	https://www.cisco.com/c/en/us/products/collateral/servers-unified-computing/ucs-c-series-rack-servers/unified-computing-accessories-eol.html

Table 43 EOL Products

EOS option PID	Description	EOL bulletin link
UCS-SD960G61X-EV	960GB 2.5 inch Enterprise Value 6G SATA SSD	https://www.cisco.com/c/en/us/products/collateral/servers-unified-computing/ucs-c-series-rack-servers/select-ucs-hyperflex-accessories-eol2.html
UCS-SD240GM1X-EV	240GB 2.5in Enter Value 6G SATA Micron G1 SSD	https://www.cisco.com/c/en/us/products/collateral/servers-unified-computing/ucs-c-series-rack-servers/unified-computing-accessories-eol.html
UCS-SD480GM1X-EV	480 GB 2.5in Enter Value 6G SATA Micron G1 SSD	https://www.cisco.com/c/en/us/products/collateral/servers-unified-computing/ucs-c-series-rack-servers/unified-computing-accessories-eol.html
UCS-SD76TM1X-EV	7.6TB 2.5in Enter Value 6G SATA Micron G1 SSD	https://www.cisco.com/c/en/us/products/collateral/servers-unified-computing/ucs-c-series-rack-servers/unified-computing-accessories-eol.html
UCSC-NVME2H-I2TBV	Cisco 2.5" U.2 2.0TB Intel P4510 NVMe High Perf. Value Endurance	https://www.cisco.com/c/en/us/products/collateral/servers-unified-computing/ucs-c-series-rack-servers/select-ucs-hyperflex-accessories-eol3.html
NVMe		
UCSC-NVMELW-I500	500GB 2.5in U.2 Intel P4501 NVMe Med. Perf. Value Endurance	https://www.cisco.com/c/en/us/products/collateral/servers-unified-computing/ucs-c-series-rack-servers/eos-eol-notice-c51-742509.html
UCSC-NVMEXP-I375	375GB 2.5in Intel Optane NVMe Extreme Perf.	https://www.cisco.com/c/en/us/products/collateral/servers-unified-computing/ucs-c-series-rack-servers/eos-eol-notice-c51-742509.html
UCSC-NVMELW-I1000	Cisco 2.5" U.2 1TB Intel P4501 NVMe Med. Perf. Value Endur (Intel)	https://www.cisco.com/c/en/us/products/collateral/servers-unified-computing/ucs-c-series-rack-servers/eos-eol-notice-c51-742509.html
UCSC-NVMEHW-I1000	Cisco 2.5" U.2 1TB Intel P4500 NVMe High Perf. Value Endurance	https://www.cisco.com/c/en/us/products/collateral/servers-unified-computing/ucs-c-series-rack-servers/eos-eol-notice-c51-742509.html
UCSC-NVMELW-I2000	Cisco 2.5" U.2 2TB Intel P4501 NVMe Perf. Value Endur (Intel)	https://www.cisco.com/c/en/us/products/collateral/servers-unified-computing/ucs-c-series-rack-servers/eos-eol-notice-c51-742509.html
UCSC-NVMEHW-I2000	Cisco 2.5" U.2 2TB Intel P4600 NVMe High Perf. High Endurance	https://www.cisco.com/c/en/us/products/collateral/servers-unified-computing/ucs-c-series-rack-servers/eos-eol-notice-c51-742823.html
UCSC-NVMEHW-I1600	Cisco 2.5" U.2 1.6TB Intel P4600 NVMe High Perf. High Endurance	https://www.cisco.com/c/en/us/products/collateral/servers-unified-computing/ucs-c-series-rack-servers/eos-eol-notice-c51-742823.html

Table 43 EOL Products

EOS option PID	Description	EOL bulletin link
UCSC-NVMEHW-I4000	Cisco 2.5" U.2 4TB Intel P4500 NVMe High Perf. Value Endurance	https://www.cisco.com/c/en/us/products/collateral/servers-unified-computing/ucs-c-series-rack-servers/eos-eol-notice-c51-742509.html
UCSC-NVMEHW-I2TBV	2TB 2.5in U.2 Intel P4500 NVMe High Perf. Value Endurance	https://www.cisco.com/c/en/us/products/collateral/servers-unified-computing/ucs-c-series-rack-servers/eos-eol-notice-c51-742823.html
UCSC-NVMEHW-I3200	3.2TB 2.5in U.2 Intel P4600 NVMe High Perf. High Endurance	https://www.cisco.com/c/en/us/products/collateral/servers-unified-computing/ucs-c-series-rack-servers/eos-eol-notice-c51-742823.html
UCSC-NVMEHW-H3200	U.2 3.2 TB HGST SN200 NVMe High Perf. High Endurance (HGST)	https://www.cisco.com/c/en/us/products/collateral/hyperconverged-infrastructure/hyperflex-hx-series/eos-eol-notice-c51-2451489.html
UCSC-NVMEHW-H1600	U.2 1.6 TB HGST SN200 NVMe High Perf. High Endurance (HGST)	https://www.cisco.com/c/en/us/products/collateral/hyperconverged-infrastructure/hyperflex-hx-series/eos-eol-notice-c51-2451489.html
UCSC-NVME-H32003	Cisco HHHL AIC 3.2T HGST SN260 NVMe Extreme Perf High Endrnc	https://www.cisco.com/c/en/us/products/collateral/servers-unified-computing/ucs-c-series-rack-servers/eos-eol-notice-c51-2412151.html
UCSC-NVMEHW-H6400	Cisco 2.5" U.2 6.4TB HGST SN200 NVMe High Perf. High Endurance	https://www.cisco.com/c/en/us/products/collateral/hyperconverged-infrastructure/hyperflex-hx-series/eos-eol-notice-c51-2451489.html
UCSC-NVME-H38401	Cisco HHHL AIC 3.8TB HGST SN260 NVMe Extreme Performance High Endurance	https://www.cisco.com/c/en/us/products/collateral/servers-unified-computing/ucs-c-series-rack-servers/eos-eol-notice-c51-2412151.html
UCSC-NVME-H64003	Cisco HHHL AIC 6.4T HGST SN260 NVMe Extreme Perf High Endrnc	https://www.cisco.com/c/en/us/products/collateral/servers-unified-computing/ucs-c-series-rack-servers/eos-eol-notice-c51-2412151.html
UCSC-NVMEHW-H7680	7.7TB 2.5in U.2 HGST SN200 NVMe High Perf. Value Endurance	https://www.cisco.com/c/en/us/products/collateral/hyperconverged-infrastructure/hyperflex-hx-series/eos-eol-notice-c51-2451489.html
UCSC-NVMEHW-H800	800GB 2.5in U.2 HGST SN200 NVMe High Perf. High Endurance	https://www.cisco.com/c/en/us/products/collateral/servers-unified-computing/ucs-c-series-rack-servers/eos-eol-notice-c51-2412151.html
UCSC-NVME2H-I1000	Cisco 2.5" U.2 1,0 TB Intel P4510 NVMe High Perf. Value Endu	https://www.cisco.com/c/en/us/products/collateral/servers-unified-computing/ucs-c-series-rack-servers/select-ucs-hyperflex-accessories-eol3.html

Table 43 EOL Products

EOS option PID	Description	EOL bulletin link
UCSC-NVME2H-I4000	Cisco 2.5" U.2 4.0TB Intel P4510 NVMe High Perf. Value Endu	https://www.cisco.com/c/en/us/products/collateral/servers-unified-computing/ucs-c-series-rack-servers/select-ucs-hyperflex-accessories-eol3.html
UCS-M2-240GB	240GB M.2 SATA Micron G1 SSD	https://www.cisco.com/c/en/us/products/collateral/servers-unified-computing/ucs-c-series-rack-servers/unified-computing-accessories-eol.html
UCS-M2-960GB	960GB M.2 SATA Micron G1 SSD	https://www.cisco.com/c/en/us/products/collateral/servers-unified-computing/ucs-c-series-rack-servers/unified-computing-accessories-eol.html
UCS-NVMEM6-W6400	6.4TB 2.5in U.2 WD SN840 NVMe Extreme Perf. High Endurance	https://www.cisco.com/c/en/us/products/collateral/servers-unified-computing/ucs-c-series-rack-servers/unified-computing-accessories-eol.html
UCS-NVMEM6-W6400	6.4TB 2.5in U.2 WD SN840 NVMe Extreme Perf. High Endurance	https://www.cisco.com/c/en/us/products/collateral/servers-unified-computing/ucs-c-series-rack-servers/unified-computing-accessories-eol.html
UCS-SD76T61X-EV	7.6TB 2.5 inch Enterprise Value 6G SATA SSD	https://www.cisco.com/c/en/us/products/collateral/servers-unified-computing/ucs-c-series-rack-servers/unified-computing-accessories-eol.html
UCS-SD76TBEM2NK9	7.6TB 2.5in Enter Value 6G SATA Micron G1 SSD (SED)	https://www.cisco.com/c/en/us/products/collateral/servers-unified-computing/ucs-c-series-rack-servers/unified-computing-accessories-eol.html
UCS-SD960GBM2NK9	960GB 2.5in Enter Value 6G SATA Micron G1 SSD (SED)	https://www.cisco.com/c/en/us/products/collateral/servers-unified-computing/ucs-c-series-rack-servers/unified-computing-accessories-eol.html
UCSC-NVME2H-I3200	Cisco 2.5" U.2 3.2TB Intel P4610 NVMe High Perf. High Endu	https://www.cisco.com/c/en/us/products/collateral/servers-unified-computing/ucs-c-series-rack-servers/unified-computing-accessories-eol.html
UCSC-NVMEHW-I8000	8TB 2.5in U.2 Intel P4510 NVMe High Perf. Value Endurance	https://www.cisco.com/c/en/us/products/collateral/servers-unified-computing/ucs-c-series-rack-servers/unified-computing-accessories-eol.html
UCS-SD960G2HTNK9	960GB Enterprise Value SSD 12G SAS SED FIPS	https://www.cisco.com/c/en/us/products/collateral/hyperconverged-infrastructure/hyperflex-hx-series/eos-eol-notice-c51-2451489.html
UCSC-F-H16003	Cisco HHL AIC 1.6T HGST SN260 NVMe Extreme Perf High Endrnc	https://www.cisco.com/c/en/us/products/collateral/servers-unified-computing/ucs-c-series-rack-servers/eos-eol-notice-c51-2412151.html
UCSC-NVME-H76801	Cisco HHL 7.7T HGST SN260 NVMe Extreme Perf Value Enderance	https://www.cisco.com/c/en/us/products/collateral/servers-unified-computing/ucs-c-series-rack-servers/eos-eol-notice-c51-2412151.html

Table 43 EOL Products

EOS option PID	Description	EOL bulletin link
UCSC-NVME2H-I1600	Cisco 2.5" U.2 1.6TB Intel P4610 NVMe High Perf. High Endu	http://https://www.cisco.com/c/en/us/products/collateral/servers-unified-computing/ucs-c-series-rack-servers/select-ucs-hyperflex-accessories-eol3.html-eol.cisco.com/eol/pbReport.html?id=ID1031408
Enterprise Performance SSDs		
UCS-SD400GBENK9	400GB Enterprise performance SAS SSD (10X DWPD, SED)	https://www.cisco.com/c/en/us/products/collateral/servers-unified-computing/ucs-c-series-rack-servers/eos-eol-notice-c51-740779.html
UCS-SD16TBENK9	1.6TB Enterprise performance SAS SSD (10XDWPD, SED)	https://www.cisco.com/c/en/us/products/collateral/servers-unified-computing/ucs-c-series-rack-servers/eos-eol-notice-c51-740779.html
UCS-SD400G12TX-EP	400 GB 2.5 inch Enterprise performance 12G SAS SSD (10X DWPD)	https://www.cisco.com/c/en/us/products/collateral/servers-unified-computing/ucs-c-series-rack-servers/eos-eol-notice-c51-740779.html
UCS-SD16T63X-EP	1.6TB 2.5 inch Enterprise performance 6GSATA SSD(3X endurance)	https://www.cisco.com/c/en/us/products/collateral/servers-unified-computing/ucs-c-series-rack-servers/eos-eol-notice-c51-740779.html
UCS-SD400H123X-EP	400 GB 2.5inch Enterprise performance 12G SAS SSD(3X endurance)	https://www.cisco.com/c/en/us/products/collateral/servers-unified-computing/ucs-c-series-rack-server s/eos-eol-notice-c51-743832.html
UCS-SD16TBENK9	1.6 TB Enterprise performance SAS SSD (10X DWPD, SED) (Micron S650DC) FIPS140-2	https://www.cisco.com/c/en/us/products/collateral/servers-unified-computing/ucs-c-series-rack-servers/eos-eol-notice-c51-740779.html
UCS-SD800G12TX-EP	800 GB 2.5 inch Enterprise performance 12G SAS SSD (10X DWPD)	https://www.cisco.com/c/en/us/products/collateral/servers-unified-computing/ucs-c-series-rack-servers/eos-eol-notice-c51-741644.html
UCS-SD16TBHKN9	1.6 TB Enterprise performance SAS SSD (10X DWPD, SED) FIPS140-2	https://www.cisco.com/c/en/us/products/collateral/servers-unified-computing/ucs-c-series-rack-servers/eos-eol-notice-c51-743832.html
UCS-SD16TB12TX-EP	1.6TB 2.5 inch Enterprise performance 12G SAS SSD(10X DWPD)	https://www.cisco.com/c/en/us/products/collateral/servers-unified-computing/ucs-c-series-rack-servers/eos-eol-notice-c51-741644.html
UCS-SD32H123X-EP	3.2 TB 2.5 inch Enterprise performance 12G SAS SSD(3X endurance)	https://www.cisco.com/c/en/us/products/collateral/servers-unified-computing/ucs-c-series-rack-servers/eos-eol-notice-c51-743832.html
UCS-SD800H123X-EP	800 GB 2.5 inch Enterprise performance 12G SAS SSD(3X endurance)	https://www.cisco.com/c/en/us/products/collateral/servers-unified-computing/ucs-c-series-rack-servers/eos-eol-notice-c51-743832.html
UCS-SD400GBHKN9	400GB Enterprise performance SAS SSD (10X DWPD, SED) FIPS140-2	https://www.cisco.com/c/en/us/products/collateral/servers-unified-computing/ucs-c-series-rack-servers/eos-eol-notice-c51-743832.html

Table 43 EOL Products

EOS option PID	Description	EOL bulletin link
UCS-SD400GBENK9	400GB Enterprise performance SAS SSD (10X DWPD, SED)	https://www.cisco.com/c/en/us/products/collateral/servers-unified-computing/ucs-c-series-rack-servers/eos-eol-notice-c51-740779.html
UCS-SD16T123X-EP	1.6 TB 2.5 inch Enterprise performance 12G SAS SSD (3X DWPD)	https://www.cisco.com/c/en/us/products/collateral/hyperconverged-infrastructure/hyperflex-hx-series/eos-eol-notice-c51-2451489.html
UCS-SD400G123X-EP	400GB 2.5in Enterprise Performance 12G SAS SSD(3X endurance)	https://www.cisco.com/c/en/us/products/collateral/hyperconverged-infrastructure/hyperflex-hx-series/eos-eol-notice-c51-2451489.html
UCS-SD32T123X-EP	3.2 TB 2.5 inch Enterprise performance 12G SAS SSD(3X DWPD)	https://www.cisco.com/c/en/us/products/collateral/hyperconverged-infrastructure/hyperflex-hx-series/eos-eol-notice-c51-2451489.html
UCS-SD800G123X-EP	800GB 2.5in Enterprise Performance 12G SAS SSD(3X endurance)	https://www.cisco.com/c/en/us/products/collateral/hyperconverged-infrastructure/hyperflex-hx-series/eos-eol-notice-c51-2451489.html
UCS-SD16H123X-EP	1.6 TB 2.5inch Enterprise performance 12G SAS SSD(3X endurance)	https://www.cisco.com/c/en/us/products/collateral/servers-unified-computing/ucs-c-series-rack-servers/eos-eol-notice-c51-743832.html
SED		
UCS-SD960GBE1NK9	960 GB Enterprise value SATA SSD (1X DWPD, SED) Non FIPS	https://www.cisco.com/c/en/us/products/collateral/hyperconverged-infrastructure/hyperflex-hx-series/eos-eol-notice-c51-2451489.html
MEMORY		
UCS-MR-X8G1RS-H	8GB DDR4-2666MHz RDIMM/PC4-21300/single rank/x4/1.2v	https://www.cisco.com/c/en/us/products/collateral/servers-unified-computing/ucs-c-series-rack-servers/eos-eol-notice-c51-740780.html
UCS-MR-X16G2RS-H	16GB DDR4-2666MHz RDIMM/PC4-21300/dual rank/x4/1.2v	https://www.cisco.com/c/en/us/products/collateral/servers-unified-computing/ucs-c-series-rack-servers/eos-eol-notice-c51-740780.html
UCS-MR-X16G1RT-H	16GB DDR4-2933MHz RDIMM 1Rx4 (8Gb)/1.2v	https://www.cisco.com/c/en/us/products/collateral/servers-unified-computing/ucs-c-series-rack-servers/ucs-hyperflex-accessories-eol14611.html
UCS-MR-X32G2RT-H	32GB DDR4-2933MHz RDIMM 2Rx4 (8Gb)/1.2v	https://www.cisco.com/c/en/us/products/collateral/servers-unified-computing/ucs-c-series-rack-servers/ucs-hyperflex-accessories-eol14611.html
UCS-MR-X64G2RT-H	64GB DDR4-2933MHz RDIMM 2Rx4 (16Gb)/1.2v	https://www.cisco.com/c/en/us/products/collateral/servers-unified-computing/ucs-c-series-rack-servers/ucs-hyperflex-accessories-eol14611.html
UCS-ML-X64G4RT-H	64GB DDR4-2933MHz LRDIMM 4Rx4 (8Gb)/1.2v	https://www.cisco.com/c/en/us/products/collateral/servers-unified-computing/ucs-c-series-rack-servers/ucs-hyperflex-accessories-eol14611.html

Table 43 EOL Products

EOS option PID	Description	EOL bulletin link
UCS-ML-128G4RT-H	128GB DDR4-2933MHz LRDIMM 4Rx4 (16Gb)/1.2v	https://www.cisco.com/c/en/us/products/collateral/servers-unified-computing/ucs-c-series-rack-servers/ucs-hyperflex-accessories-eol14611.html
UCS-ML-X64G4RS-H	64GB DDR4-2666-MHz LRDIMM/PC4-21300/quad rank/x4/1.2v	https://www.cisco.com/c/en/us/products/collateral/servers-unified-computing/ucs-c-series-rack-servers/eos-eol-notice-c51-2412151.html
UCS-ML-X64G4RS-H	64GB DDR4-2666-MHz LRDIMM/PC4-21300/quad rank/x4/1.2v	https://www.cisco.com/c/en/us/products/collateral/servers-unified-computing/ucs-c-series-rack-servers/eos-eol-notice-c51-2412151.html
UCS-ML-X32G2RS-H	32GB DDR4-2666-MHz LRDIMM/PC4-21300/dual rank/x4/1.2v	https://www.cisco.com/c/en/us/products/collateral/servers-unified-computing/ucs-c-series-rack-servers/eos-eol-notice-c51-2412151.html
UCS-ML-X32G2RSHM	32GB DDR4-2666-MHz LRDIMM/dual rank/x4/1.2v. Micron only	https://www.cisco.com/c/en/us/products/collateral/servers-unified-computing/ucs-c-series-rack-servers/eos-eol-notice-c51-2412151.html
UCS-ML-X64G4RS-H	64GB DDR4-2666-MHz LRDIMM/PC4-21300/quad rank/x4/1.2v	https://www.cisco.com/c/en/us/products/collateral/servers-unified-computing/ucs-c-series-rack-servers/eos-eol-notice-c51-2412151.html
UCS-ML-X64G4RSHM	64GB DDR4-2666-MHz LRDIMM/quad rank/x4/1.2v. Micron only	https://www.cisco.com/c/en/us/products/collateral/servers-unified-computing/ucs-c-series-rack-servers/eos-eol-notice-c51-2412151.html
UCS-ML-X64G4RSHS	64GB DDR4-2666-MHz LRDIMM/quad rank/x4/1.2v. Samsung only	https://www.cisco.com/c/en/us/products/collateral/servers-unified-computing/ucs-c-series-rack-servers/eos-eol-notice-c51-2412151.html
UCS-MR-128G8RS-H	128GB DDR4-2666-MHz TSV-RDIMM/PC4-21300/octal rank/x4/1.2v	https://www.cisco.com/c/en/us/products/collateral/servers-unified-computing/ucs-c-series-rack-servers/eos-eol-notice-c51-2412151.html
UCS-MR-X16G1RS-H	16GB DDR4-2666-MHz RDIMM/PC4-21300/single rank/x4/1.2v	https://www.cisco.com/c/en/us/products/collateral/servers-unified-computing/ucs-c-series-rack-servers/eos-eol-notice-c51-2412151.html
UCS-MR-X16G1RSHM	16GB DDR4-2666-MHz RDIMM/single rank/x4/1.2v. Micron only	https://www.cisco.com/c/en/us/products/collateral/servers-unified-computing/ucs-c-series-rack-servers/eos-eol-notice-c51-2412151.html
UCS-MR-X32G2RS-H	32GB DDR4-2666-MHz RDIMM/PC4-21300/dual rank/x4/1.2v	https://www.cisco.com/c/en/us/products/collateral/servers-unified-computing/ucs-c-series-rack-servers/eos-eol-notice-c51-2412151.html
UCS-MR-X32G2RSHM	32GB DDR4-2666-MHz RDIMM/dual rank/x4/1.2v. Micron only	https://www.cisco.com/c/en/us/products/collateral/servers-unified-computing/ucs-c-series-rack-servers/eos-eol-notice-c51-2412151.html
UCS-MR-X32G2RSHS	32GB DDR4-2666-MHz RDIMM/dual rank/x4/1.2v. Samsung only	https://www.cisco.com/c/en/us/products/collateral/servers-unified-computing/ucs-c-series-rack-servers/eos-eol-notice-c51-2412151.html
UCS-MR-X64G4RS-H	64GB DDR4-2666-MHz TSV-RDIMM/PC4-21300/quad	https://www.cisco.com/c/en/us/products/collateral/servers-unified-computing/ucs-c-series-rack-servers/eos-eol-notice-c51-2412151.html

Table 43 EOL Products

EOS option PID	Description	EOL bulletin link
UCS-ML-256G8RT-H	256GB DDR4-2933-MHz LRDIMM/8Rx4/1.2v	https://www.cisco.com/c/en/us/products/collateral/servers-unified-computing/ucs-b-series-blade-servers/select-ucs-accessories-eol.html
CPU		
UCS-CPU-I8280M	Intel 8280M 2.7GHz/205W 28C/38.50MB 3DX DDR4 2TB 2933 MHz	https://www.cisco.com/c/en/us/products/collateral/servers-unified-computing/ucs-c-series-rack-servers/eos-eol-notice-c51-743832.html
UCS-CPU-I8276M	Intel 8276M 2.2GHz/165W 28C/38.50MB 3DX DDR4 2TB 2933 MHz	https://www.cisco.com/c/en/us/products/collateral/servers-unified-computing/ucs-c-series-rack-servers/eos-eol-notice-c51-743832.html
UCS-CPU-I8260M	Intel 8260M 2.4GHz/165W 24C/35.75MB 3DX DDR4 2TB 2933 MHz	https://www.cisco.com/c/en/us/products/collateral/servers-unified-computing/ucs-c-series-rack-servers/eos-eol-notice-c51-743832.html
UCS-CPU-I6240M	Intel 6240M 2.6GHz/150W 18C/24.75MB 3DX DDR4 2TB 2933 MHz	https://www.cisco.com/c/en/us/products/collateral/servers-unified-computing/ucs-c-series-rack-servers/eos-eol-notice-c51-743832.html
UCS-CPU-I6238M	Intel 6238M 2.1GHz/140W 22C/30.25MB 3DX DDR4 2TB 2933 MHz	https://www.cisco.com/c/en/us/products/collateral/servers-unified-computing/ucs-c-series-rack-servers/eos-eol-notice-c51-743832.html
UCS-CPU-I5215M	Intel 5215M 2.5GHz/85W 10C/13.75MB 3DX DDR4 2TB 2666 MHz	https://www.cisco.com/c/en/us/products/collateral/servers-unified-computing/ucs-c-series-rack-servers/eos-eol-notice-c51-743832.html
UCS-CPU-8180M	2.5 GHz 8180M/205W 28C/38.50MB Cache/DDR4-2666MHz	https://www.cisco.com/c/en/us/products/collateral/servers-unified-computing/ucs-c-series-rack-servers/eos-eol-notice-c51-744580.html
UCS-CPU-8176M	2.1 GHz 8176M/165W 28C/38.50MB Cache/DDR4-2666MHz	https://www.cisco.com/c/en/us/products/collateral/servers-unified-computing/ucs-c-series-rack-servers/eos-eol-notice-c51-744580.html
UCS-CPU-8170M	2.1 GHz 8170M/165W 26C/35.75MB Cache/DDR4-2666MHz	https://www.cisco.com/c/en/us/products/collateral/servers-unified-computing/ucs-c-series-rack-servers/eos-eol-notice-c51-744580.html
UCS-CPU-8160M	2.1 GHz 8160M/150W 24C/33MB Cache/DDR4-2666MHz	https://www.cisco.com/c/en/us/products/collateral/servers-unified-computing/ucs-c-series-rack-servers/eos-eol-notice-c51-744580.html
UCS-CPU-8180	2.5 GHz 8180/205W 28C/38.50MB Cache/DDR4-2666MHz	https://www.cisco.com/c/en/us/products/collateral/servers-unified-computing/ucs-c-series-rack-servers/eos-eol-notice-c51-744580.html
UCS-CPU-8176	2.1 GHz 8176/165W 28C/38.50MB Cache/DDR4-2666MHz	https://www.cisco.com/c/en/us/products/collateral/servers-unified-computing/ucs-c-series-rack-servers/eos-eol-notice-c51-744580.html
UCS-CPU-8170	2.1 GHz 8170/165W 26C/35.75MB Cache/DDR4-2666MHz	https://www.cisco.com/c/en/us/products/collateral/servers-unified-computing/ucs-c-series-rack-servers/eos-eol-notice-c51-744580.html
UCS-CPU-8168	2.7 GHz 8168/205W 24C/33MB Cache/DDR4-2666MHz	https://www.cisco.com/c/en/us/products/collateral/servers-unified-computing/ucs-c-series-rack-servers/eos-eol-notice-c51-744580.html

Table 43 EOL Products

EOS option PID	Description	EOL bulletin link
UCS-CPU-8164	2.0 GHz 8164/150W 26C/35.75MB Cache/DDR4-2666MHz	https://www.cisco.com/c/en/us/products/collateral/servers-unified-computing/ucs-c-series-rack-servers/eos-eol-notice-c51-744580.html
UCS-CPU-8160T	2.1 GHz 8160/150W 24C/33MB Cache/DDR4-2666MHz	https://www.cisco.com/c/en/us/products/collateral/servers-unified-computing/ucs-c-series-rack-servers/eos-eol-notice-c51-744580.html
UCS-CPU-8160	2.1 GHz 8160/150W 24C/33MB Cache/DDR4-2666MHz	https://www.cisco.com/c/en/us/products/collateral/servers-unified-computing/ucs-c-series-rack-servers/eos-eol-notice-c51-744580.html
UCS-CPU-8158	3.0 GHz 8158/150W 12C/24.75MB Cache/DDR4-2666MHz	https://www.cisco.com/c/en/us/products/collateral/servers-unified-computing/ucs-c-series-rack-servers/eos-eol-notice-c51-744580.html
UCS-CPU-8156	3.6 GHz 8156/105W 4C/16.50MB Cache/DDR4-2666MHz	https://www.cisco.com/c/en/us/products/collateral/servers-unified-computing/ucs-c-series-rack-servers/eos-eol-notice-c51-744580.html
UCS-CPU-8153	2.0 GHz 8153/125W 16C/22MB Cache/DDR4-2666MHz	https://www.cisco.com/c/en/us/products/collateral/servers-unified-computing/ucs-c-series-rack-servers/eos-eol-notice-c51-744580.html
UCS-CPU-6142M	2.6 GHz 6142M/150W 16C/22MB Cache/DDR4-2666MHz	https://www.cisco.com/c/en/us/products/collateral/servers-unified-computing/ucs-c-series-rack-servers/eos-eol-notice-c51-744580.html
UCS-CPU-6140M	2.3 GHz 6140M/140W 18C/24.75MB Cache/DDR4-2666MHz	https://www.cisco.com/c/en/us/products/collateral/servers-unified-computing/ucs-c-series-rack-servers/eos-eol-notice-c51-744580.html
UCS-CPU-6134M	3.2 GHz 6134M/130W 8C/24.75MB Cache/DDR4-2666MHz	https://www.cisco.com/c/en/us/products/collateral/servers-unified-computing/ucs-c-series-rack-servers/eos-eol-notice-c51-744580.html
UCS-CPU-6154	3.0 GHz 6154/200W 18C/24.75MB Cache/DDR4-2666MHz	https://www.cisco.com/c/en/us/products/collateral/servers-unified-computing/ucs-c-series-rack-servers/eos-eol-notice-c51-744580.html
UCS-CPU-6152	2.1 GHz 6152/140W 22C/30.25MB Cache/DDR4-2666MHz	https://www.cisco.com/c/en/us/products/collateral/servers-unified-computing/ucs-c-series-rack-servers/eos-eol-notice-c51-744580.html
UCS-CPU-6150	2.7 GHz 6150/165W 18C/24.75MB Cache/DDR4-2666MHz	https://www.cisco.com/c/en/us/products/collateral/servers-unified-computing/ucs-c-series-rack-servers/eos-eol-notice-c51-744580.html
UCS-CPU-6148	2.4 GHz 6148/150W 20C/27.50MB Cache/DDR4-2666MHz	https://www.cisco.com/c/en/us/products/collateral/servers-unified-computing/ucs-c-series-rack-servers/eos-eol-notice-c51-744580.html
UCS-CPU-6144	3.5 GHz 6144/150W 8C/24.75MB Cache/DDR4-2666MHz	https://www.cisco.com/c/en/us/products/collateral/servers-unified-computing/ucs-c-series-rack-servers/eos-eol-notice-c51-744580.html
UCS-CPU-6142	2.6 GHz 6142/150W 16C/22MB Cache/DDR4-2666MHz	https://www.cisco.com/c/en/us/products/collateral/servers-unified-computing/ucs-c-series-rack-servers/eos-eol-notice-c51-744580.html
UCS-CPU-6140	2.3 GHz 6140/140W 18C/24.75MB Cache/DDR4-2666MHz	https://www.cisco.com/c/en/us/products/collateral/servers-unified-computing/ucs-c-series-rack-servers/eos-eol-notice-c51-744580.html

Table 43 EOL Products

EOS option PID	Description	EOL bulletin link
UCS-CPU-6138T	2.0 GHz 6138T/125W 20C/27.5MB Cache/DDR4-2666MHz	https://www.cisco.com/c/en/us/products/collateral/servers-unified-computing/ucs-c-series-rack-servers/eos-eol-notice-c51-744580.html
UCS-CPU-6138	2.0 GHz 6138/125W 20C/27.5MB Cache/DDR4-2666MHz	https://www.cisco.com/c/en/us/products/collateral/servers-unified-computing/ucs-c-series-rack-servers/eos-eol-notice-c51-744580.html
UCS-CPU-6136	3.0 GHz 6136/150W 12C/24.75MB Cache/DDR4-2666MHz	https://www.cisco.com/c/en/us/products/collateral/servers-unified-computing/ucs-c-series-rack-servers/eos-eol-notice-c51-744580.html
UCS-CPU-6134	3.2 GHz 6134/130W 8C/24.75MB Cache/DDR4-2666MHz	https://www.cisco.com/c/en/us/products/collateral/servers-unified-computing/ucs-c-series-rack-servers/eos-eol-notice-c51-744580.html
UCS-CPU-6132	2.6 GHz 6132/140W 14C/19.25MB Cache/DDR4-2666MHz	https://www.cisco.com/c/en/us/products/collateral/servers-unified-computing/ucs-c-series-rack-servers/eos-eol-notice-c51-744580.html
UCS-CPU-6130	2.1 GHz 6130/125W 16C/22MB Cache/DDR4-2666MHz	https://www.cisco.com/c/en/us/products/collateral/servers-unified-computing/ucs-c-series-rack-servers/eos-eol-notice-c51-744580.html
UCS-CPU-6128	3.4 GHz 6128/115W 6C/19.25MB Cache/DDR4-2666MHz	https://www.cisco.com/c/en/us/products/collateral/servers-unified-computing/ucs-c-series-rack-servers/eos-eol-notice-c51-744580.html
UCS-CPU-6126	2.6 GHz 6126/125W 12C/19.25MB Cache/DDR4-2666MHz	https://www.cisco.com/c/en/us/products/collateral/servers-unified-computing/ucs-c-series-rack-servers/eos-eol-notice-c51-744580.html
UCS-CPU-5122	3.6 GHz 5122/105W 4C/16.50MB Cache/DDR4-2666MHz	https://www.cisco.com/c/en/us/products/collateral/servers-unified-computing/ucs-c-series-rack-servers/eos-eol-notice-c51-744580.html
UCS-CPU-5120	2.2 GHz 5120/105W 14C/19.25MB Cache/DDR4 2400MHz	https://www.cisco.com/c/en/us/products/collateral/servers-unified-computing/ucs-c-series-rack-servers/eos-eol-notice-c51-744580.html
UCS-CPU-5118	2.3 GHz 5118/105W 12C/16.50MB Cache/DDR4 2400MHz	https://www.cisco.com/c/en/us/products/collateral/servers-unified-computing/ucs-c-series-rack-servers/eos-eol-notice-c51-744580.html
UCS-CPU-5117	2.0 GHz 5117/105W 14C/19.25MB Cache/DDR4 2400MHz	https://www.cisco.com/c/en/us/products/collateral/servers-unified-computing/ucs-c-series-rack-servers/eos-eol-notice-c51-744580.html
UCS-CPU-5115	2.4 GHz 5115/85W 10C/13.75MB Cache/DDR4 2400MHz	https://www.cisco.com/c/en/us/products/collateral/servers-unified-computing/ucs-c-series-rack-servers/eos-eol-notice-c51-744580.html
UCS-CPU-I3204	Intel 3204 1.9GHz/85W 6C/8.25MB DDR4 2133MHz	https://www.cisco.com/c/en/us/products/collateral/servers-unified-computing/ucs-c-series-rack-servers/select-ucs-accessories-eol.html
UCS-CPU-I4214Y	Intel 4214Y SS 2.2GHz/85W 12/10/8C 16.75MB DDR4 2400MHz	https://www.cisco.com/c/en/us/products/collateral/servers-unified-computing/ucs-c-series-rack-servers/select-ucs-accessories-eol.html
UCS-CPU-I6250	Intel 6250 3.9GHz/185W 8C/35.75MB PMM DDR4 1TB 2933 MHz	https://www.cisco.com/c/en/us/products/collateral/servers-unified-computing/ucs-c-series-rack-servers/select-ucs-accessories-eol.html

Table 43 EOL Products

EOS option PID	Description	EOL bulletin link
UCS-CPU-I6252N	Intel 6252N 2.3GHz/150W 24C/35.75MB DCP DDR4 2933 MHz	https://www.cisco.com/c/en/us/products/collateral/servers-unified-computing/ucs-c-series-rack-servers/select-ucs-accessories-eol.html
UCS-CPU-4116	2.1 GHz 4116/85W 12C/16.50MB Cache/DDR4 2400MHz	https://www.cisco.com/c/en/us/products/collateral/servers-unified-computing/ucs-c-series-rack-servers/eos-eol-notice-c51-744580.html
UCS-CPU-4114	2.2 GHz 4114/85W 10C/13.75MB Cache/DDR4 2400MHz	https://www.cisco.com/c/en/us/products/collateral/servers-unified-computing/ucs-c-series-rack-servers/eos-eol-notice-c51-744580.html
UCS-CPU-4112	2.6 GHz 4112/85W 4C/8.25MB Cache/DDR4 2400MHz	https://www.cisco.com/c/en/us/products/collateral/servers-unified-computing/ucs-c-series-rack-servers/eos-eol-notice-c51-744580.html
UCS-CPU-4110	2.1 GHz 4110/85W 8C/11MB Cache/DDR4 2400MHz	https://www.cisco.com/c/en/us/products/collateral/servers-unified-computing/ucs-c-series-rack-servers/eos-eol-notice-c51-744580.html
UCS-CPU-4108	1.8 GHz 4108/85W 8C/11MB Cache/DDR4 2400MHz	https://www.cisco.com/c/en/us/products/collateral/servers-unified-computing/ucs-c-series-rack-servers/eos-eol-notice-c51-744580.html
UCS-CPU-3106	1.7 GHz 3106/85W 8C/11MB Cache/DDR4 2133 MHz	https://www.cisco.com/c/en/us/products/collateral/servers-unified-computing/ucs-c-series-rack-servers/eos-eol-notice-c51-744580.html
UCS-CPU-3104	1.7 GHz 3104/85W 6C/8.25MB Cache/DDR4 2133 MHz	https://www.cisco.com/c/en/us/products/collateral/servers-unified-computing/ucs-c-series-rack-servers/eos-eol-notice-c51-744580.html
GPU		
UCSC-GPU-P100-12G	NVIDIA P100 12 GB	https://www.cisco.com/c/en/us/products/collateral/servers-unified-computing/ucs-c-series-rack-servers/eos-eol-notice-c51-741579.html
UCSC-GPU-P100-16G	NVIDIA P100 16 GB	https://www.cisco.com/c/en/us/products/collateral/servers-unified-computing/ucs-c-series-rack-servers/eos-eol-notice-c51-741579.html
UCSC-GPU-V340	AMD Radeon Pro V340, 2X16GB,	https://www.cisco.com/c/en/us/products/collateral/servers-unified-computing/ucs-c-series-rack-servers/eos-eol-notice-c51-741579.html
UCSC-GPU-7150x2	AMD Firepro 7150x2	https://www.cisco.com/c/en/us/products/collateral/servers-unified-computing/ucs-c-series-rack-servers/eos-eol-notice-c51-741579.html
UCSC-GPU-P40	NVIDIA P40	https://www.cisco.com/c/en/us/products/collateral/servers-unified-computing/ucs-c-series-rack-servers/eos-eol-notice-c51-744204.html

Table 43 EOL Products

EOS option PID	Description	EOL bulletin link
UCSC-GPU-V100	NVIDIA V100 16GB	https://www.cisco.com/c/en/us/products/collateral/servers-unified-computing/ucs-c-series-rack-servers/eos-eol-notice-c51-744204.html
UCSC-GPU-V100-32	NVIDIA V100 32GB	https://www.cisco.com/c/en/us/products/collateral/servers-unified-computing/ucs-c-series-rack-servers/ucs-hyperflex-accessories-eol.html
UCSC-GPU-RTX6000	QUADRO RTX 6000, PASSIVE, 250W TGP, 24GB	https://www.cisco.com/c/en/us/products/collateral/servers-unified-computing/ucs-c-series-rack-servers/select-ucs-hyperflex-accessories-eol.html
UCSC-GPU-RTX8000	QUADRO RTX 8000, PASSIVE, 250W TGP, 48GB	https://www.cisco.com/c/en/us/products/collateral/servers-unified-computing/ucs-c-series-rack-servers/select-ucs-hyperflex-accessories-eol.html
Microsoft Windows server		
MSWS-16-ST16C	Windows Server 2016 Standard (16 Cores/2 VMs)	https://www.cisco.com/c/en/us/products/servers-unified-computing/ucs-c-series-rack-servers/eos-eol-notice-c51-743145.html
MSWS-16-ST24C	Windows Server 2016 Standard (24 Cores/2 VMs)	https://www.cisco.com/c/en/us/products/servers-unified-computing/ucs-c-series-rack-servers/eos-eol-notice-c51-743145.html
MSWS-16-ST16C-NS	Windows Server 2016 Standard (16 Cores/2 VMs) - No Cisco SVC	https://www.cisco.com/c/en/us/products/servers-unified-computing/ucs-c-series-rack-servers/eos-eol-notice-c51-743145.html
MSWS-16-ST24C-NS	Windows Server 2016 Standard (24 Cores/2 VMs) - No Cisco SVC	https://www.cisco.com/c/en/us/products/servers-unified-computing/ucs-c-series-rack-servers/eos-eol-notice-c51-743145.html
MSWS-16-DC16C	Windows Server 2016 Data Center (16 Cores/Unlimited VMs)	https://www.cisco.com/c/en/us/products/servers-unified-computing/ucs-c-series-rack-servers/eos-eol-notice-c51-743145.html
MSWS-16-DC24C	Windows Server 2016 Data Center (24 Cores/Unlimited VMs)	https://www.cisco.com/c/en/us/products/servers-unified-computing/ucs-c-series-rack-servers/eos-eol-notice-c51-743145.html
MSWS-16-DC16C-NS	Windows Server 2016 DC (16 Cores/Unlim VMs) - No Cisco SVC	https://www.cisco.com/c/en/us/products/servers-unified-computing/ucs-c-series-rack-servers/eos-eol-notice-c51-743145.html
MSWS-16-DC24C-NS	Windows Server 2016 DC (24 Cores/Unlim VMs) - No Cisco SVC	https://www.cisco.com/c/en/us/products/servers-unified-computing/ucs-c-series-rack-servers/eos-eol-notice-c51-743145.html
OS Media		
MSWS-16-ST16C-RM	Windows Server 2016 Std (16 Cores/2 VMs) - Recovery Media	https://www.cisco.com/c/en/us/products/servers-unified-computing/ucs-c-series-rack-servers/eos-eol-notice-c51-743145.html
MSWS-16-ST24C-RM	Windows Server 2016 Std (24 Cores/2 VMs) - Recovery Media	https://www.cisco.com/c/en/us/products/servers-unified-computing/ucs-c-series-rack-servers/eos-eol-notice-c51-743145.html
MSWS-16-DC16C-RM	Windows Server 2016 DC (16 Cores/Unlim VMs) - Recovery Media	https://www.cisco.com/c/en/us/products/servers-unified-computing/ucs-c-series-rack-servers/eos-eol-notice-c51-743145.html

Table 43 EOL Products

EOS option PID	Description	EOL bulletin link
MSWS-16-DC24C-RM	Windows Server 2016 DC (24 Cores/Unlim VMs) - Recovery Media	https://www.cisco.com/c/en/us/products/servers-unified-computing/ucs-c-series-rack-servers/eos-eol-notice-c51-743145.html
Operating system		
SLES-2SUV-1A	SUSE Linux Enterprise Svr (1-2 CPU,Unl VM); 1-Yr Support Req	
SLES-2SUV-1S	SUSE Linux Enterprise Svr (1-2 CPU,Unl VM); Prio 1-Yr SnS	
SLES-2SUV-3A	SUSE Linux Enterprise Svr (1-2 CPU,Unl VM); 3-Yr Support Req	
SLES-2SUV-3S	SUSE Linux Enterprise Svr (1-2 CPU,Unl VM); Prio 3-Yr SnS	
SLES-2SUV-5A	SUSE Linux Enterprise Svr (1-2 CPU,Unl VM); 5-Yr Support Req	
SLES-2SUV-5S	SUSE Linux Enterprise Svr (1-2 CPU,Unl VM); Prio 5-Yr SnS	
SLES-SAP-2SUV-1A	SLES for SAP Apps w/ HA (1-2 CPU, Unl VM); 1-Yr Support Reqd	
SLES-SAP-2SUV-1S	SLES for SAP Apps (1-2 CPU, Unl VM); Priority 1-Yr SnS	
SLES-SAP-2SUV-3A	SLES for SAP Apps w/ HA (1-2 CPU, Unl VM); 3-Yr Support Reqd	
SLES-SAP-2SUV-3S	SLES for SAP Apps (1-2 CPU, Unl VM); Priority 3-Yr SnS	
SLES-SAP-2SUV-5A	SLES for SAP Apps w/ HA (1-2 CPU, Unl VM); 5-Yr Support Reqd	
SLES-SAP-2SUV-5S	SLES for SAP Apps (1-2 CPU, Unl VM); Priority 5-Yr SnS	

TECHNICAL SPECIFICATIONS

Dimensions and Weight

Table 44 UCS C240 M5 Dimensions and Weight

Parameter	Value
Height	3.43 in. (87.1 mm)
Width (including slam latches)	17.57 in. (446.3 mm) Including handles: 18.96 in (481.5 mm)
Depth	29.56 in. (750.8 mm) Including handles: 30.44 in (773.1 mm)
Front Clearance	3 in. (76 mm)
Side Clearance	1 in. (25 mm)
Rear Clearance	6 in. (152 mm)
Weight ¹	
Maximum (24 HDD model with 26 HDDs, 2 CPUs, 24 DIMMs, 2 1600 W power supplies) (8 HDD model with 8 HDDs, 2 CPUs, 24 DIMMs, 2 1600 W power supplies)	59.5 lbs (26.1 kg) 45.5 lbs (20.6 kg)
Minimum (24 HDD model with 1 HDD, 1 CPU, 1 DIMM, 1 770 W power supply) (8 HDD model with 1 HDD, 1 CPU, 1 DIMM, 1 770 W power supply)	41.5 lbs (18.8 kg) 37 lbs (16.8 kg)
Bare (24 HDD model with 0 HDD, 0 CPU, 0 DIMM, 1 770 W power supply) (8 HDD model with 0 HDD, 0 CPU, 0 DIMM, 1 770 W power supply)	40 lbs (18.1 kg) 35.5 lbs (16.1 kg)

Notes:

1. Weight includes inner rail, which is attached to the server. Weight does not include outer rail, which is attached to the rack.

Power Specifications

The server is available with the following types of power supplies:

- 770 W (AC) power supply (see [Table 45](#))
- 1050 W (AC) power supply (see [Table 46](#)).
- 1050 W V2 (DC) power supply (see [Table 47](#))
- 1600 W (AC) power supply (see [Table 48](#))

Table 45 UCS C240 M5 SFF Power Specifications (770 W AC power supply)

Parameter	Specification			
Input Connector	IEC320 C14			
Input Voltage Range (V rms)	100 to 240			
Maximum Allowable Input Voltage Range (V rms)	90 to 264			
Frequency Range (Hz)	50 to 60			
Maximum Allowable Frequency Range (Hz)	47 to 63			
Maximum Rated Output (W)	770			
Maximum Rated Standby Output (W)	36			
Nominal Input Voltage (V rms)	100	120	208	230
Nominal Input Current (A rms)	8.8	7.4	4.2	3.8
Maximum Input at Nominal Input Voltage (W)	855	855	855	846
Maximum Input at Nominal Input Voltage (VA)	882	882	882	872
Minimum Rated Efficiency (%) ¹	90	90	90	91
Minimum Rated Power Factor ¹	0.97	0.97	0.97	0.97
Maximum Inrush Current (A peak)	15			
Maximum Inrush Current (ms)	0.2			
Minimum Ride-Through Time (ms) ²	12			

Notes:

1. This is the minimum rating required to achieve 80 PLUS Platinum certification, see test reports published at <http://www.80plus.org/> for certified values
2. Time output voltage remains within regulation limits at 100% load, during input voltage dropout

Table 46 UCS C240 M5 1050 W (AC) Power Supply Specifications

Parameter	Specification
Input Connector	IEC320 C14
Input Voltage Range (V rms)	100 to 240
Maximum Allowable Input Voltage Range (V rms)	90 to 264
Frequency Range (Hz)	50 to 60

Table 46 UCS C240 M5 1050 W (AC) Power Supply Specifications

Maximum Allowable Frequency Range (Hz)	47 to 63			
Maximum Rated Output (W) ¹	800		1050	
Maximum Rated Standby Output (W)	36			
Nominal Input Voltage (V rms)	100	120	208	230
Nominal Input Current (A rms)	9.2	7.6	5.8	5.2
Maximum Input at Nominal Input Voltage (W)	889	889	1167	1154
Maximum Input at Nominal Input Voltage (VA)	916	916	1203	1190
Minimum Rated Efficiency (%) ²	90	90	90	91
Minimum Rated Power Factor ²	0.97	0.97	0.97	0.97
Maximum Inrush Current (A peak)	15			
Maximum Inrush Current (ms)	0.2			
Minimum Ride-Through Time (ms) ³	12			

Notes:

1. Maximum rated output is limited to 800W when operating at low-line input voltage (100-127V)
2. This is the minimum rating required to achieve 80 PLUS Platinum certification, see test reports published at <http://www.80plus.org/> for certified values
3. Time output voltage remains within regulation limits at 100% load, during input voltage dropout

Table 47 UCS C240 M5 1050 W (DC) Power Supply Specifications

Parameter	Specification
Input Connector	Molex 42820
Input Voltage Range (V rms)	-48
Maximum Allowable Input Voltage Range (V rms)	-40 to -72
Frequency Range (Hz)	NA
Maximum Allowable Frequency Range (Hz)	NA
Maximum Rated Output (W)	1050
Maximum Rated Standby Output (W)	36
Nominal Input Voltage (V rms)	-48
Nominal Input Current (A rms)	24
Maximum Input at Nominal Input Voltage (W)	1154
Maximum Input at Nominal Input Voltage (VA)	1154
Minimum Rated Efficiency (%) ¹	91
Minimum Rated Power Factor ¹	NA
Maximum Inrush Current (A peak)	15
Maximum Inrush Current (ms)	0.2
Minimum Ride-Through Time (ms) ²	5

Notes:

1. This is the minimum rating required to achieve 80 PLUS Platinum certification, see test reports published at <http://www.80plus.org/> for certified values
2. Time output voltage remains within regulation limits at 100% load, during input voltage dropout

Table 48 UCS C240 M5 1600 W (AC) Power Supply Specifications

Parameter	Specification			
Input Connector	IEC320 C14			
Input Voltage Range (V rms)	200 to 240			
Maximum Allowable Input Voltage Range (V rms)	180 to 264			
Frequency Range (Hz)	50 to 60			
Maximum Allowable Frequency Range (Hz)	47 to 63			
Maximum Rated Output (W)	1600			
Maximum Rated Standby Output (W)	36			
Nominal Input Voltage (V rms)	100	120	208	230
Nominal Input Current (A rms)	NA	NA	8.8	7.9
Maximum Input at Nominal Input Voltage (W)	NA	NA	1778	1758
Maximum Input at Nominal Input Voltage (VA)	NA	NA	1833	1813
Minimum Rated Efficiency (%) ¹	NA	NA	90	91
Minimum Rated Power Factor ²	NA	NA	0.97	0.97
Maximum Inrush Current (A peak)	30			
Maximum Inrush Current (ms)	0.2			
Minimum Ride-Through Time (ms) ²	12			

Notes:

1. This is the minimum rating required to achieve 80 PLUS Platinum certification, see test reports published at <http://www.80plus.org/> for certified values
2. Time output voltage remains within regulation limits at 100% load, during input voltage dropout

For configuration-specific power specifications, use the Cisco UCS Power Calculator at this URL:

<http://ucspowercalc.cisco.com>

Environmental Specifications

The environmental specifications for the C240 M5 SFF server are listed in [Table 49](#).

Table 49 UCS C240 M5 SFF Environmental Specifications

Parameter	Minimum
Operating Temperature	Dry bulb temperature of 10°C to 35°C (50°F to 95°F) Maximum temperature change of 20°C (36°F) per hour (a temperature change within a specified period of time and not a rate of change) Humidity condition: Uncontrolled, not to exceed 50% RH starting condition Derate the maximum temperature by 1°C (33.8°F) per every 305 meters of altitude above 900m
Extended Operating Temperature	5°C to 40°C (41°F to 104°F) with no direct sunlight Humidity condition: Uncontrolled, not to exceed 50% RH starting condition Derate the maximum temperature by 1°C (33.8°F) per every 305 meters of altitude above 900m
Non-Operating Temperature	Dry bulb temperature of -40°C to 65°C (-40°F to 149°F)
Operating Relative Humidity	10% to 90% and 28°C (82.4°F) maximum dew-point temperature, non-condensing environment Minimum to be higher (more moisture) of -12°C (10.4°F) dew point or 8% relative humidity Maximum to be 24°C (75.2°F) dew point or 90% relative humidity
Non-Operating Relative Humidity	5% to 93% relative humidity, non-condensing, with a maximum wet bulb temperature of 28°C across the 20°C to 40°C dry bulb range.
Maximum Operating Duration	Unlimited
Operating Altitude	A maximum elevation of 3050 meters (10,006 ft)
Non-Operating Altitude	An elevation of 0 to 12,000 meters (39,370 ft)
Sound Power level, Measure A-weighted per ISO7779 LWAd (Bels) Operation at 23°C (73°F)	5.5
Sound Pressure level, Measure A-weighted per ISO7779 LpAm (dBA) Operation at 23°C (73°F)	40

Extended Operating Temperature Hardware Configuration Limits

Table 50 Cisco UCS C240 M5 Extended Operating Temperature Hardware Configuration Limits

Platform ¹	ASHRAE A3 (5°C to 40°C) ²	ASHRAE A4 (5°C to 45°C) ³
Processors:	155W+	155W+ and 105W+ (4 or 6 Cores)
Memory:	LRDIMMs	LRDIMMs
Storage:	M.2 SATA SSDs NVMe SSDs	M.2 SATA SSDs NVMe SSDs HDDs or SSDs (Rear Bays)
Peripherals:	PCIe NVMe SSDs GPUs	PCIe NVMe SSDs GPUs VICs (Slots 1 and 4) NICs (Slots 1 and 4) HBAs (Slots 1 and 4)

Notes:

1. Two PSUs are required and PSU failure is not supported
2. Non-Cisco UCS qualified peripherals and/or peripherals that consume more than 25W are not supported
3. High power or maximum power fan control policy must be applied

Compliance Requirements

The regulatory compliance requirements for C-Series servers are listed in [Table 51](#)

Table 51 UCS C-Series Regulatory Compliance Requirements

Parameter	Description
Regulatory Compliance	Products should comply with CE Markings per directives 2014/30/EU and 2014/35/EU
Safety	UL 60950-1 Second Edition CAN/CSA-C22.2 No. 60950-1 Second Edition EN 60950-1 Second Edition IEC 60950-1 Second Edition AS/NZS 60950-1 GB4943 2001
EMC - Emissions	47CFR Part 15 (CFR 47) Class A AS/NZS CISPR32 Class A CISPR32 Class A EN55032 Class A ICES003 Class A VCCI Class A EN61000-3-2 EN61000-3-3 KN32 Class A CNS13438 Class A
EMC - Immunity	EN55024 CISPR24 EN300386 KN35



Americas Headquarters
Cisco Systems, Inc.
San Jose, CA

Asia Pacific Headquarters
Cisco Systems (USA) Pte. Ltd.
Singapore

Europe Headquarters
Cisco Systems International BV Amsterdam,
The Netherlands

Cisco has more than 200 offices worldwide. Addresses, phone numbers, and fax numbers are listed on the Cisco Website at www.cisco.com/go/offices.

Cisco and the Cisco Logo are trademarks of Cisco Systems, Inc. and/or its affiliates in the U.S. and other countries. A listing of Cisco's trademarks can be found at www.cisco.com/go/trademarks. Third party trademarks mentioned are the property of their respective owners. The use of the word partner does not imply a partnership relationship between Cisco and any other company. (1005R)

