

Cisco HyperFlex HX240C M6 All NVMe, All Flash and Hybrid Server Nodes

A printed version of this document is only a copy and not necessarily the latest version. Refer to the following link for the latest released version:

<https://www.cisco.com/c/en/us/products/hyperconverged-infrastructure/hyperflex-hx-series/datasheet-listing.html>



CONTENTS

OVERVIEW	5
DETAILED VIEWS	8
Chassis Front View - HXAF240C-M6SN (All NVMe)	8
Chassis Rear View - HXAF240C-M6SN (All NVMe)	9
Chassis Front View - HXAF240C-M6SX (All Flash)	11
Chassis Rear View - HXAF240C-M6SX (All Flash)	12
Chassis Front View - HX240C-M6SX (Hybrid)	15
Chassis Rear View - HX240C-M6SX (Hybrid)	16
BASE SERVER NODE STANDARD CAPABILITIES and FEATURES	19
CONFIGURING the SERVER	23
STEP 1 VERIFY SERVER SKU	24
STEP 2 SELECT DEPLOYMENT MODE (OPTIONAL)	26
STEP 3 SELECT RISER CARDS (REQUIRED)	27
STEP 4 SELECT CPU(s)	28
STEP 5 SELECT MEMORY	33
Memory Configurations, Features, and Modes	35
STEP 6 SELECT DRIVE CONTROLLERS	39
STEP 7 SELECT DRIVES	40
STEP 8 SELECT HYPERFLEX CONNECTIVITY MODE	49
STEP 9 SELECT OPTION CARD(s)	50
STEP 10 ORDER OPTIONAL PCIe OPTION CARD ACCESSORIES	53
STEP 11 ORDER GPU CARDS (OPTIONAL)	56
STEP 12 ORDER POWER SUPPLY	58
STEP 13 SELECT INPUT POWER CORD(s)	59
STEP 14 ORDER TOOL-LESS RAIL KIT AND OPTIONAL REVERSIBLE CABLE MANAGEMENT ARM	63
STEP 15 ORDER SECURITY DEVICES (OPTIONAL)	64
STEP 16 SELECT LOCKING SECURITY BEZEL (OPTIONAL)	65
STEP 17 SELECT HYPERVISOR / HOST OPERATING SYSTEM	66
STEP 18 SELECT HYPERFLEX DATA PLATFORM (HXDP) SOFTWARE	67
STEP 19 CISCO INTERSIGHT	68
STEP 20 SELECT INSTALLATION SERVICE	69
STEP 21 SELECT SERVICE and SUPPORT LEVEL	70
SUPPLEMENTAL MATERIAL	78
Hyperconverged Systems	78
Serial Port Details	83
KVM Cable	83
Chassis	84
Risers	86
Riser Card Configuration and Options	88
SPARE PARTS	94
UPGRADING or REPLACING CPUs	108
UPGRADING or REPLACING MEMORY	109
TECHNICAL SPECIFICATIONS	110
Dimensions and Weight	110
Power Specifications	112
Environmental Specifications	118
Extended Operating Temperature Hardware Configuration Limits	120
Compliance Requirements	122

OVERVIEW

Cisco HyperFlex™ Systems unlock the full potential of hyperconvergence. The systems are based on an end-to-end software-defined infrastructure, combining software-defined computing in the form of Cisco Unified Computing System (Cisco UCS) servers; software-defined storage with the powerful Cisco HX Data Platform and software-defined networking with the Cisco UCS fabric that will integrate smoothly with Cisco Application Centric Infrastructure (Cisco ACI™). Together with a single point of connectivity and hardware management, these technologies deliver a preintegrated and adaptable cluster that is ready to provide a unified pool of resources to power applications as your business needs dictate.

The Cisco HyperFlex HX240C M6 All NVMe/All Flash/Hybrid Server Nodes extends the capabilities of Cisco's HyperFlex portfolio in a 2U form factor with the addition of the 3rd Gen Intel® Xeon® Scalable Processors (Ice Lake), 16 DIMM slots per CPU for 3200-MHz DDR4 DIMMs with DIMM capacity points up to 256 GB. The maximum memory capacity for 2 CPUs is listed here:

- 8 TB (32 x 256 GB DDR4 DIMMs), or
- 12 TB (16 x 256 GB DDR4 DIMMs and 16 x 512 GB Intel® Optane™ Persistent Memory Modules (PMem)).

There are three servers to choose from:

- **HXAF240C-M6SN (All NVMe)** (see [Figure 1 on page 6](#)):
 - Up to 24 front NVMe (only) drives.
 - I/O centric option provides up to 6 PCIe slots using two rear risers.
 - Storage-centric option provides 3 PCIe slots using slots in one of the rear risers and up to 2 rear drives.
- **HXAF240C-M6SX (All Flash)** (see [Figure 1 on page 7](#)):
 - Up to 24 front SFF SAS/SATA SSDs and NVMe caching drive.
 - I/O centric option provides up to 8 PCIe slots using all three rear risers.
 - Storage-centric option provides 3 PCIe slots using slots in one of the rear risers and two rear risers with a total of up to 4 SFF drives.
- **HX240C-M6SX (Hybrid)** (see [Figure 1 on page 7](#)):
 - Up to 24 front SFF SAS/SATA HDDs and SSDs
 - I/O centric option provides up to 8 PCIe slots using all three rear risers
 - Storage-centric option provides 3 PCIe slots using slots in one of the rear risers and two rear risers with a total of up to 4 SFF drives

The server provides one or two internal slots (depending on the server type) for the following:

- Two slots for Cisco 12G SAS pass-through HBAs. Each HBA controls up to 16 SAS/SATA drives



NOTE: PCIe drives are controlled directly from the CPUs.

The HyperFlex HX240C M6 All NVMe/All Flash/Hybrid Server Nodes has two LOM ports (10Gbase-T LOM) and a single 1 GbE management port. A modular LAN on motherboard (mLOM) module provides up to two 100 GbE ports. A connector on the front of the chassis provides KVM functionality.

Deployment Options

Starting with HyperFlex 4.5(2a) the following 2 deployment options are supported:

- **HX Data Center with Fabric Interconnect** - This deployment option connects the server to Cisco Fabric Interconnect. The installation for this type of deployment can be done using the standalone installer or from the Intersight.
- **HX Data Center without Fabric Interconnect** - This deployment option allows server nodes to be directly connected to existing switches. The installation for this type of deployment can be done from the Intersight only.

See [Figure 1 on page 6](#) for front and rear views of all the configurations of the HyperFlex HX240C M6 All NVMe/All Flash/Hybrid Server Nodes.

Figure 1 Cisco HX240C M6 All NVMe/All Flash/Hybrid Server Nodes

HXAF240C-M6SN (All NVMe)

24 front drives are all NVMe (only) drives optionally 2 NVMe rear drives

Front View (see [Figure 2 on page 8](#) for details)



Rear View (all slots shown unpopulated - see [Figure 3 on page 9](#) for details)

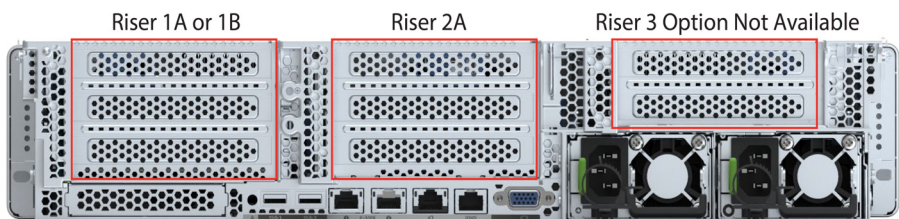

Figure 1 Cisco HX240C M6 All NVMe/All Flash/Hybrid Server Nodes

HXAF240C-M6SX (All Flash)

24 Front drives are SAS/SATA/NVMe and optionally 4 SAS/SATA/NVMe rear drives

Front View (see [Figure 4 on page 11](#) for details)



Rear View (all slots shown unpopulated - see [Figure 5 on page 12](#) for details)

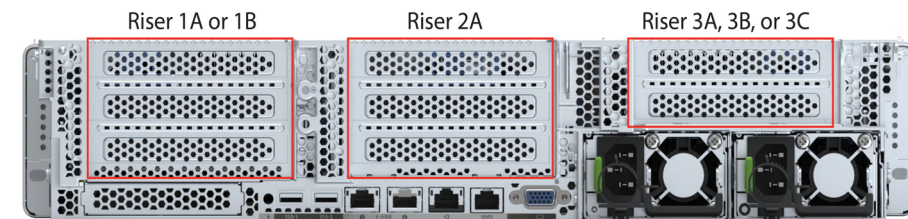

HX240C-M6SX (Hybrid)

24 Front drives are SAS/SATA HDDS & SSDs and optionally 4 SAS/SATA rear drives

Front View (see [Figure 6 on page 15](#) for details)



Rear View (all slots shown unpopulated - see [Figure 7 on page 16](#) for details)

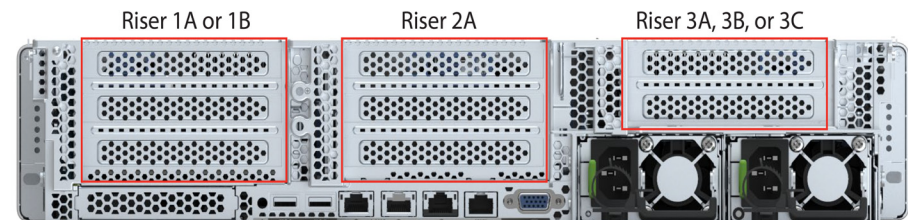

DETAILED VIEWS

Chassis Front View - HXAF240C-M6SN (All NVMe)

Figure 2 shows the front View of the HXAF240C-M6SN (All NVMe) Server configured with 24 SFF NVMe front drives and optionally two rear capacity drives. The drives are all NVMe drives.

Figure 2 Chassis Front View: HXAF240C-M6SN (All NVMe)

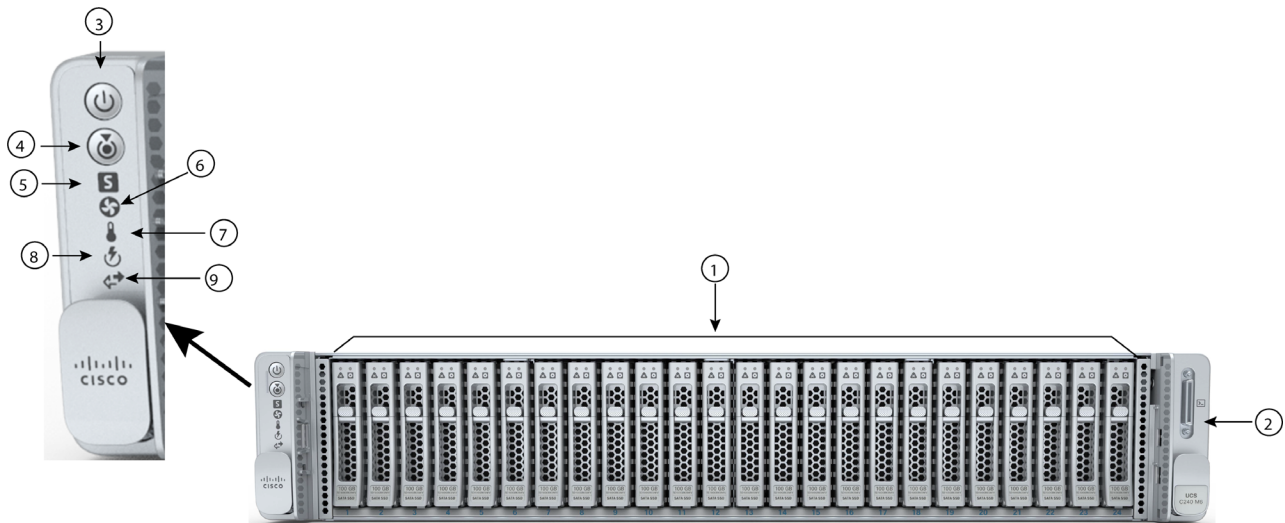

1	Drive bays 1 - 24 support NVMe PCIe drives (only) ¹	6	Fan status LED
2	KVM connector (used with KVM cable that provides two USB 2.0, one VGA, and one serial connector)	7	Temperature status LED
3	Power button/Power status LED	8	Power supply status LED
4	Unit Identification button/LED	9	Network link activity LED
5	System status LED	-	-

Notes:

1. When NVMe drives are selected, you must also select 2 CPUs.

Chassis Rear View - HXAF240C-M6SN (All NVMe)

Figure 3 shows the external features of the rear panel. The I/O centric version shows all PCIe slots (two slots are not supported). The storage centric version shows a combination of PCIe risers and storage bays.

Figure 3 Chassis Rear View: HXAF240C-M6SN (All NVMe)

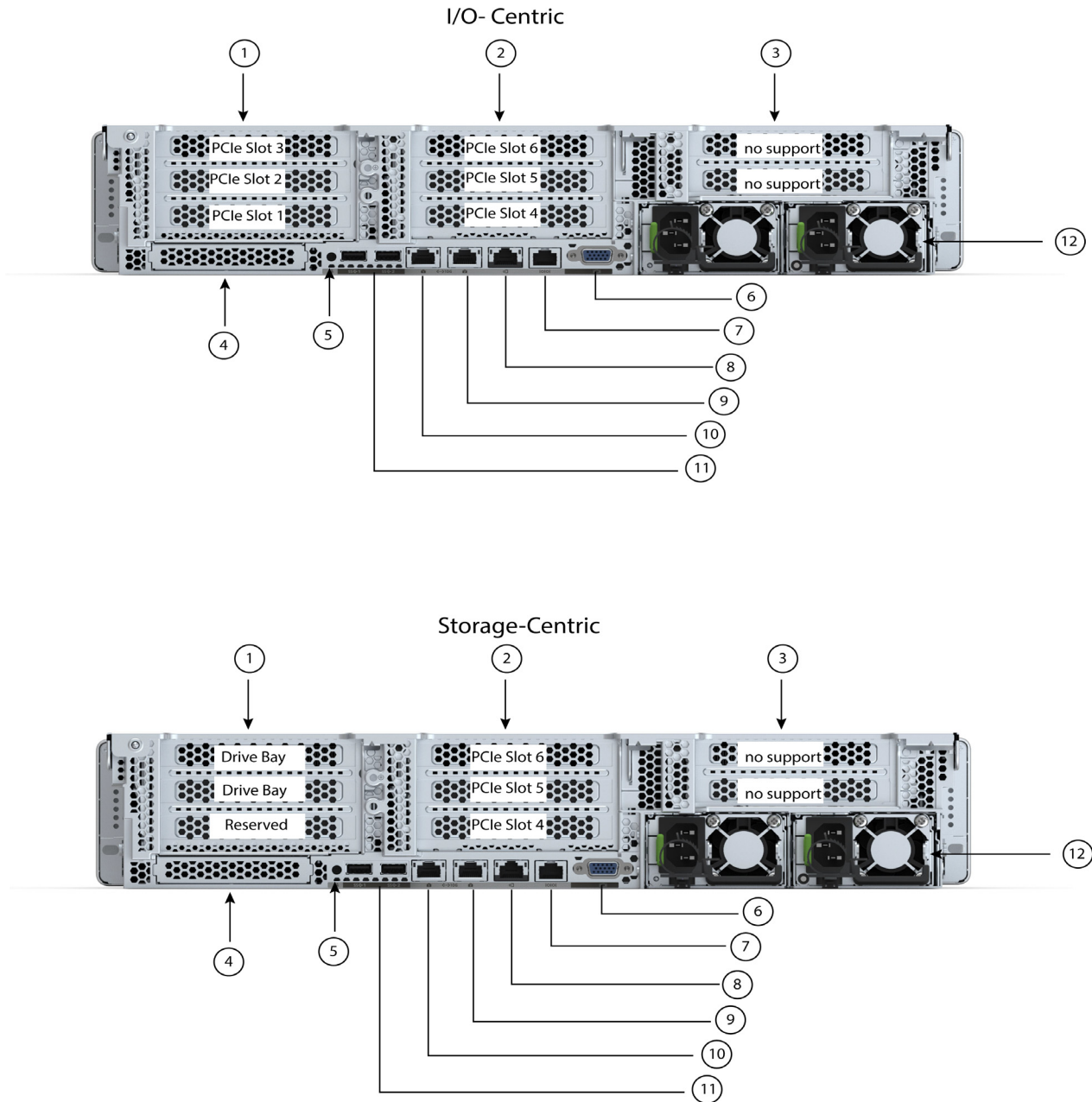

1	<p>There are two Riser 1 options:</p> <p>Riser 1A (I/O centric, CPU1 control)</p> <ul style="list-style-type: none"> ■ Supports three PCIe slots: <ul style="list-style-type: none"> • Slot 1 is full-height, 3/4 length, x8, NCSI • Slot 2 is full-height, full-length, x16, NCSI • Slot 3 is full-height, full-length, x8, no NCSI <p>Riser 1B (storage-centric, CPU1 control)</p> <ul style="list-style-type: none"> ■ Supports two NVMe drives <ul style="list-style-type: none"> • Slot 1 is reserved • Slot 2 (drive bay 102), x4 (CPU1 control) • Slot 3 (drive bay 101), x4 (CPU1 control) <p>See Riser Card Configuration and Options, page 87 for details.</p>	7	COM port (RJ45 connector)
2	<p>Riser 2A (always I/O centric, CPU2 control)</p> <ul style="list-style-type: none"> ■ Supports three PCIe slots: <ul style="list-style-type: none"> • Slot 4 is full-height, 3/4 length, x8 • Slot 5 is full-height, full-length, x16 • Slot 6 is full-height, full length, x8 <p>See Riser Card Configuration and Options, page 87 for details.</p>	8	1 GbE dedicated Ethernet management port
3	<p>Riser 3A, 3B, and 3C</p> <ul style="list-style-type: none"> ■ Not supported 	9 -10	Dual 1/10 GbE Ethernet ports (LAN1, LAN2) LAN1 is left connector, LAN2 is right connector
4	Modular LAN-on-motherboard (mLOM) card slot (x16)	11	USB 3.0 ports (two)
5	System ID pushbutton/LED	12	Power supplies (two)
6	VGA display port (DB15 connector)	-	-



NOTE: For GPU support on a particular riser slot, see [Table 20 on page 55](#)

Chassis Front View - HXAF240C-M6SX (All Flash)

Figure 4 shows the front View of the HXAF240C-M6SX (All Flash) Server configured with 24 front drives.

Figure 4 Chassis Front View: HXAF240C-M6SX (All Flash)

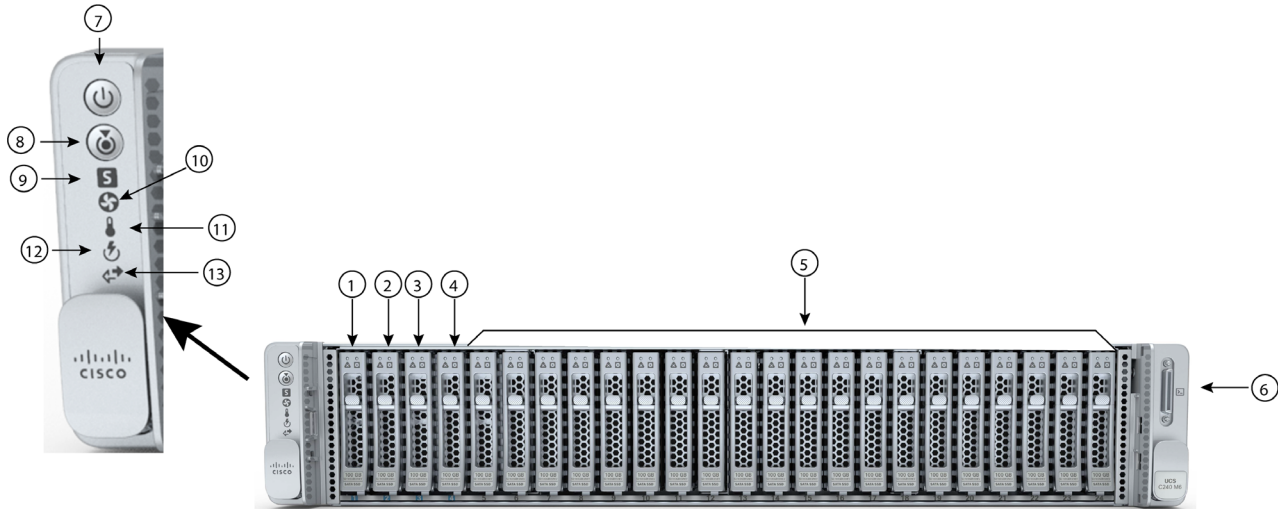

1 - 4	Drive bays 1 - 4 support SAS/SATA solid state drives (SSDs) as well as NVMe PCIe drives ¹	9	System status LED
5	Drive bays 5 - 24 support SAS/SATA solid state drives (SSDs) only	10	Fan status LED
6	KVM connector (used with KVM cable that provides two USB 2.0, one VGA, and one serial connector)	11	Temperature status LED
7	Power button/Power status LED	12	Power supply status LED
8	Unit Identification button/LED	13	Network link activity LED

Notes:

1. If NVMe drives are selected, you must also select 2 CPUs.

Chassis Rear View - HXAF240C-M6SX (All Flash)

Figure 5 shows the external features of the rear panel. The I/O centric version shows all PCIe slots. The storage centric version shows a combination of PCIe risers and storage bays.

Figure 5 Chassis Rear View: HXAF240C-M6SX (All Flash)

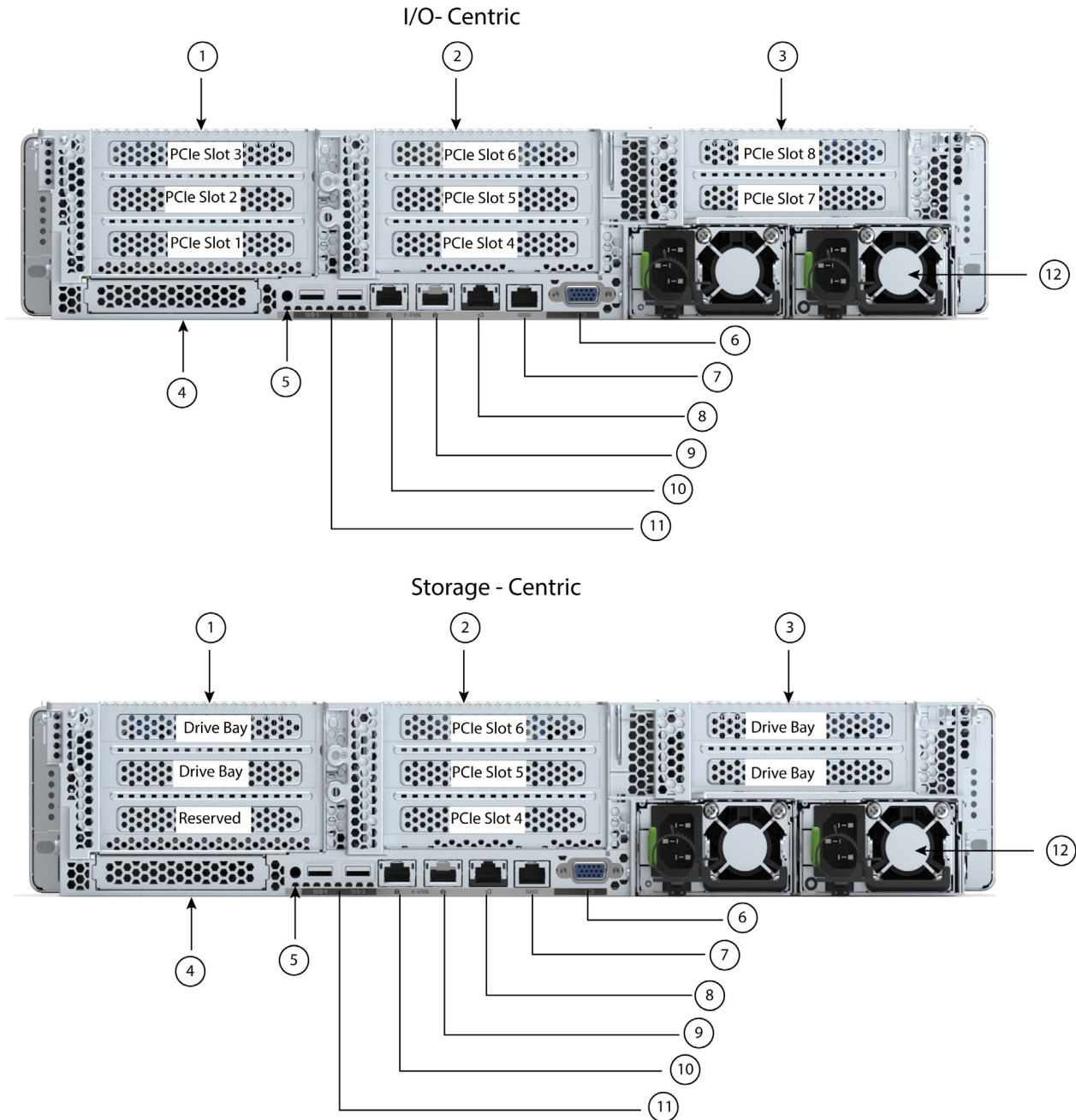

<p>1</p>	<p>There are two Riser 1 options:</p> <p>Riser 1A (I/O centric, CPU1 control)</p> <ul style="list-style-type: none"> ■ Supports three PCIe slots: <ul style="list-style-type: none"> • Slot 1 is full-height, 3/4 length, x8, NCSI • Slot 2 is full-height, full-length, x16, NCSI • Slot 3 is full-height, full-length, x8, no NCSI <p>Riser 1B (storage-centric, CPU1 control)</p> <ul style="list-style-type: none"> ■ Supports two SFF drives (SAS/SATA/NVMe) <ul style="list-style-type: none"> • Slot 1 is reserved • Slot 2 (drive bay 102), x4 (CPU1 control) • Slot 3 (drive bay 101), x4 (CPU1 control) • When using a hardware drive controller card (SAS HBA) in the server, SAS/SATA SSDs or NVMe PCIe SSDs are supported in the rear bays. <p>See Riser Card Configuration and Options, page 87 for details.</p>	<p>7</p>	<p>COM port (RJ45 connector)</p>
<p>2</p>	<p>Riser 2A (always I/O centric, CPU2 control)</p> <ul style="list-style-type: none"> ■ Supports three PCIe slots: <ul style="list-style-type: none"> • Slot 4 is full-height, 3/4 length, x8 • Slot 5 is full-height, full-length, x16 • Slot 6 is full-height, full length, x8 <p>See Riser Card Configuration and Options, page 87 for details.</p>	<p>8</p>	<p>1 GbE dedicated Ethernet management port</p>
<p>3</p>	<p>There are three Riser 3 options:</p> <p>Riser 3A (I/O centric, CPU2 control)</p> <ul style="list-style-type: none"> ■ Supports two PCIe slots: <ul style="list-style-type: none"> • Slot 7 is full-height, full-length, x8, no NCSI • Slot 8 is full-height, full-length, x8, no NCSI <p>Riser 3B (storage-centric, CPU2 control)</p> <ul style="list-style-type: none"> ■ Supports two SFF drives (SAS/SATA/NVMe) <ul style="list-style-type: none"> • Slot 7 (drive bay 104), x4 • Slot 8 (drive bay 103), x4 • When using a hardware drive controller card (SAS HBA) in the server, SAS/SATA SSDs or NVMe PCIe drives are supported in the rear bays. <p>Riser 3C (for GPU, CPU2 control)</p> <ul style="list-style-type: none"> ■ Supports one full-height, full-length, double-wide GPU (PCIe slot 7 only), x16 ■ Slot 8 is blocked by double-wide GPU <p>See Riser Card Configuration and Options, page 87 for details.</p>	<p>9 -10</p>	<p>Dual 1/10 GbE Ethernet ports (LAN1, LAN2)</p> <p>LAN1 is left connector, LAN2 is right connector</p>
<p>4</p>	<p>Modular LAN-on-motherboard (mLOM) card slot (x16)</p>	<p>11</p>	<p>USB 3.0 ports (two)</p>

DETAILED VIEWS

5	System ID pushbutton/LED	12	Power supplies (two)
6	VGA display port (DB15 connector)	-	-



NOTE: For GPU support on a particular riser slot, see [Table 20 on page 55](#)

Chassis Front View - HX240C-M6SX (Hybrid)

Figure 4 shows the front View of the HX240C-M6SX (Hybrid) Server Node configured with 24 front drives and optionally 4 SAS/SATA rear drives.

Figure 6 Chassis Front View: HX240C-M6SX (Hybrid)

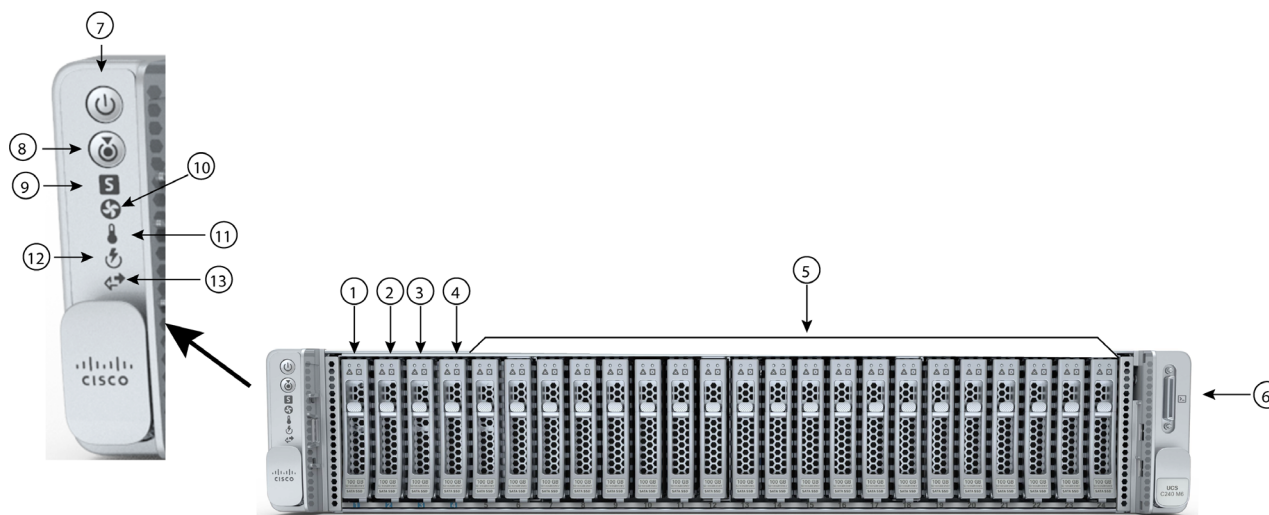

1 - 4	Drive bays 1 - 4 support SAS/SATA hard drives (HDDs) and solid state drives (SSDs)	9	System status LED
5	Drive bays 5 - 24 support SAS/SATA hard drives (HDDs) only	10	Fan status LED
6	KVM connector (used with KVM cable that provides two USB 2.0, one VGA, and one serial connector)	11	Temperature status LED
7	Power button/Power status LED	12	Power supply status LED
8	Unit Identification button/LED	13	Network link activity LED

Chassis Rear View - HX240C-M6SX (Hybrid)

Figure 5 shows the external features of the rear panel. The I/O centric version shows all PCIe slots. The storage centric version shows a combination of PCIe risers and storage bays.

Figure 7 Chassis Rear View: HX240C-M6SX (Hybrid)

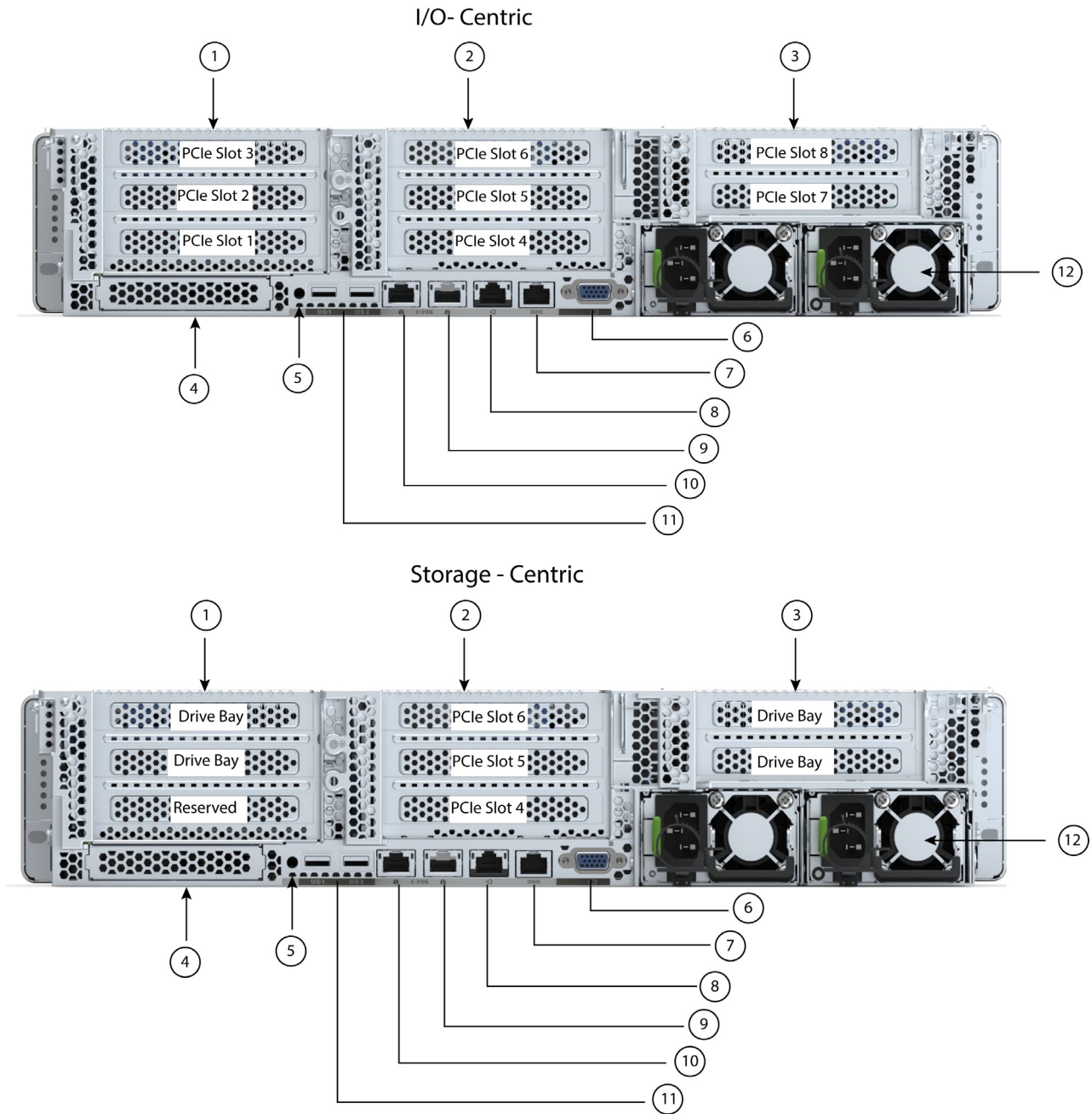

1	<p>There are two Riser 1 options:</p> <p>Riser 1A (I/O centric, CPU1 control)</p> <ul style="list-style-type: none"> ■ Supports three PCIe slots: <ul style="list-style-type: none"> • Slot 1 is full-height, 3/4 length, x8, NCSI • Slot 2 is full-height, full-length, x16, NCSI • Slot 3 is full-height, full-length, x8, no NCSI <p>Riser 1B (storage-centric, CPU1 control)</p> <ul style="list-style-type: none"> ■ Supports two SFF drives (SAS/SATA) <ul style="list-style-type: none"> • Slot 1 is reserved • Slot 2 (drive bay 102), x4 (CPU1 control) • Slot 3 (drive bay 101), x4 (CPU1 control) • When using a hardware drive controller card (SAS HBA) in the server, SAS/SATA HDDs or SSDs or PCIe drives are supported in the rear bays. <p>See Riser Card Configuration and Options, page 87 for details.</p>	7	COM port (RJ45 connector)
2	<p>Riser 2A (always I/O centric, CPU2 control)</p> <ul style="list-style-type: none"> ■ Supports three PCIe slots: <ul style="list-style-type: none"> • Slot 4 is full-height, 3/4 length, x8 • Slot 5 is full-height, full-length, x16 • Slot 6 is full-height, full length, x8 <p>See Riser Card Configuration and Options, page 87 for details.</p>	8	1 GbE dedicated Ethernet management port

<p>3</p>	<p>There are three Riser 3 options</p> <p>Riser 3A (I/O centric, CPU2 control)</p> <ul style="list-style-type: none"> ■ Supports two PCIe slots: <ul style="list-style-type: none"> • Slot 7 is full-height, full-length, x8, no NCSI • Slot 8 is full-height, full-length, x8, no NCSI <p>Riser 3B (storage-centric, CPU2 control)</p> <ul style="list-style-type: none"> ■ Supports two SFF drives (SAS/SATA) <ul style="list-style-type: none"> • Slot 7 (drive bay 104), x4 • Slot 8 (drive bay 103), x4 • When using a hardware drive controller card (SAS HBA) in the server, SAS/SATA HDDs or SSDs or PCIe drives are supported in the rear bays. <p>Riser 3C (for GPU, CPU2 control)</p> <ul style="list-style-type: none"> ■ Supports one full-height, full-length, double-wide GPU (PCIe slot 7 only), x16 ■ Slot 8 is blocked by double-wide GPU <p>See Riser Card Configuration and Options, page 87 for details.</p>	<p>9 -10</p>	<p>Dual 1/10 GbE Ethernet ports (LAN1, LAN2)</p> <p>LAN1 is left connector, LAN2 is right connector</p>
<p>4</p>	<p>Modular LAN-on-motherboard (mLOM) card slot (x16)</p>	<p>11</p>	<p>USB 3.0 ports (two)</p>
<p>5</p>	<p>System ID pushbutton/LED</p>	<p>12</p>	<p>Power supplies (two)</p>
<p>6</p>	<p>VGA display port (DB15 connector)</p>	<p>-</p>	<p>-</p>



NOTE: For GPU support on a particular riser slot, see [Table 20 on page 55](#)

BASE SERVER NODE STANDARD CAPABILITIES and FEATURES

Table 1 lists the capabilities and features of the base server. Details about how to configure the server for a particular feature or capability (for example, number of processors, disk drives, or amount of memory) are provided in *CONFIGURING the SERVER, page 23*.

Table 1 Capabilities and Features

Capability/Feature	Description
Chassis	Two rack unit (2RU) chassis
CPU	One or two 3rd Gen Intel® Xeon® Scalable Processors (Ice Lake) ¹
Chipset	Intel® C621A series chipset
Memory	32 slots for registered DIMMs (RDIMMs) or load-reduced DIMMs (LRDIMMs) and support for Intel® Optane™ Persistent Memory Modules (PMem)
Multi-bit Error Protection	This server supports multi-bit error protection.
Video	<p>The Cisco Integrated Management Controller (CIMC) provides video using the Matrox G200e video/graphics controller:</p> <ul style="list-style-type: none"> ■ Integrated 2D graphics core with hardware acceleration ■ Embedded DDR memory interface supports up to 512 MB of addressable memory (8 MB is allocated by default to video memory) ■ Supports display resolutions up to 1920 x 1200 16bpp @ 60Hz ■ High-speed integrated 24-bit RAMDAC ■ Single lane PCI-Express host interface running at Gen 1 speed
Power subsystem	<p>Up to two of the following hot-swappable power supplies:</p> <ul style="list-style-type: none"> ■ 1050 W (AC) ■ 1050 W (DC) ■ 1600 W (AC) ■ 2300 W (AC) <p>One power supply is mandatory; one more can be added for 1 + 1 redundancy.</p>
Front Panel	A front panel controller provides status indications and control buttons.
ACPI	This server supports the advanced configuration and power interface (ACPI) 6.2 standard.
Fans	Six hot-swappable fans for front-to-rear cooling

Capability/ Feature	Description
Expansion slots	<ul style="list-style-type: none"> ■ Riser 1A (3 PCIe slots) ■ Riser 1B (2 drive bays) ■ Riser 2A (3 PCIe slots) ■ Riser 3A (2 PCIe slots) ■ Riser 3B (2 drive bays) ■ Riser 3C (1 full-length, double-wide GPU)  <p>Note: Not all risers are available in every server configuration option.</p> <p>For more details on the variations of riser 1, riser 2, and riser 3, see Riser Card Configuration and Options, page 87.</p>
Interfaces	<ul style="list-style-type: none"> ■ Rear panel <ul style="list-style-type: none"> • One 1Gbase-T RJ-45 management port • Two 10Gbase-T LOM ports • One RS-232 serial port (RJ45 connector) • One DB15 VGA connector • Two USB 3.0 port connectors • One flexible modular LAN on motherboard (mLOM) slot that can accommodate various interface cards ■ Front panel <ul style="list-style-type: none"> • One KVM console connector (supplies two USB 2.0 connectors, one VGA DB15 video connector, and one serial port (RS232) RJ45 connector)

Capability/ Feature	Description
Internal storage devices	<p><u>Drive storage:</u> The server is orderable in three different server node:</p> <p>HXAF240C-M6SN (All NVMe):</p> <ul style="list-style-type: none"> ■ Up to 24 SFF NVMe PCIe solid state drives (SSDs) only. 24 Drives are used as below: <ul style="list-style-type: none"> • Six to twenty-two NVMe SSD (for capacity) • One NVMe SSD (for caching) • One NVMe SSD (system drive for HXDP operations) ■ Up to 2 rear NVMe solid state drives (SSDs) only (Optional) <p>NOTE: Two CPUs are required when choosing NVMe SSDs.</p> <p>HXAF240C-M6SX (All Flash):</p> <ul style="list-style-type: none"> ■ Up to 24 front SFF SAS/SATA/NVMe solid state drives (SSDs). 24 Drives are used as below: <ul style="list-style-type: none"> • Six to twenty-two SAS/SATA SSD or six to twenty-two SED SAS/SATA SSD (for capacity) • One NVMe SSD or one SAS/SATA SSD or one SED SAS/SATA SSD (for caching) • One SAS/SATA SSD (system drive for HXDP operations) ■ Up to 4 SFF rear-facing SAS/SATA/NVMe drives (Optional) <p>HX240C-M6SX (Hybrid):</p> <ul style="list-style-type: none"> ■ Up to 24 front SFF hard drives (HDDs) and solid state drives (SSDs). 24 Drives are used as below: <ul style="list-style-type: none"> • Six to twenty-two SAS HDD or six to twenty-two SED SAS HDD (for capacity) • One SAS/SATA SSD or one SED SAS/SATA SSD (for caching) • One SAS/SATA SSD (system drive for HXDP operations) ■ Up to 4 SFF rear-facing SAS/SATA drives (Optional) <p><u>Other storage:</u></p> <ul style="list-style-type: none"> ■ A mini-storage module connector on the motherboard supports a boot-optimized RAID controller carrier that holds two SATA M.2 SSDs. Mixing different capacity SATA M.2 SSDs is not supported.
Integrated management processor	<p>Baseboard Management Controller (BMC) running Cisco Integrated Management Controller (CIMC) firmware.</p> <p>Depending on your CIMC settings, the CIMC can be accessed through the 1GE dedicated management port, the 1GE/10GE LOM ports, or a Cisco virtual interface card (VIC).</p> <p>CIMC manages certain components within the server, such as the Cisco 12G SAS HBA.</p>

Capability/Feature	Description
Storage controllers	<p>One or two 12G SAS HBAs plug into a dedicated slot.</p> <ul style="list-style-type: none"> ■ Cisco M6 12G SAS HBA (for Hybrid and All Flash servers): <ul style="list-style-type: none"> • No RAID support • JBOD/Pass-through Mode support • Each HBA supports up to 16 SAS/SATA internal drives
Modular LAN on Motherboard (mLOM) slot	<p>The dedicated mLOM slot on the motherboard can flexibly accommodate the following cards:</p> <ul style="list-style-type: none"> ■ Cisco Virtual Interface Cards
Intersight	Intersight provides server management capabilities
CIMC	Cisco Integrated Management Controller 4.2(1) or later

Notes:

1. If NVMe drives are selected, you must also select 2 CPUs.

CONFIGURING the SERVER

Follow these steps to configure the Cisco HyperFlex HX240C M6 All NVMe/All Flash/Hybrid Server Nodes:

- *STEP 1 VERIFY SERVER SKU, page 24*
- *STEP 2 SELECT DEPLOYMENT MODE (OPTIONAL), page 25*
- *STEP 3 SELECT RISER CARDS (REQUIRED), page 26*
- *STEP 4 SELECT CPU(s), page 27*
- *STEP 5 SELECT MEMORY, page 32*
- *STEP 6 SELECT DRIVE CONTROLLERS, page 38*
- *STEP 7 SELECT DRIVES, page 39*
- *STEP 8 SELECT HYPERFLEX CONNECTIVITY MODE, page 48*
- *STEP 9 SELECT OPTION CARD(s), page 49*
- *STEP 10 ORDER OPTIONAL PCIe OPTION CARD ACCESSORIES, page 52*
- *STEP 11 ORDER GPU CARDS (OPTIONAL), page 55*
- *STEP 12 ORDER POWER SUPPLY, page 57*
- *STEP 13 SELECT INPUT POWER CORD(s), page 58*
- *STEP 14 ORDER TOOL-LESS RAIL KIT AND OPTIONAL REVERSIBLE CABLE MANAGEMENT ARM, page 62*
- *STEP 15 ORDER SECURITY DEVICES (OPTIONAL), page 63*
- *STEP 16 SELECT LOCKING SECURITY BEZEL (OPTIONAL), page 64*
- *STEP 17 SELECT HOST OPERATING SYSTEM, page 65*
- *STEP 18 SELECT HYPERFLEX DATA PLATFORM (HXDP) SOFTWARE, page 66*
- *STEP 19 CISCO INTERSIGHT, page 67*
- *STEP 20 SELECT INSTALLATION SERVICE, page 68*
- *SUPPLEMENTAL MATERIAL, page 77*

STEP 1 VERIFY SERVER SKU

Table 2 PID of Major Line Bundle (MLB)

Product ID (PID)	Description
HX-M6-MLB	HX/HXAF/EDG M6 MLB This major line bundle (MLB) consists of the HyperFlex All Flash, Hybrid and Edge Server Nodes, with Intersight and HXDP software spare PIDs.

Select one server product ID (PID) from [Table 3](#).

Table 3 PID of the HX240C M6 All NVMe/All Flash/Hybrid Server Nodes

Product ID (PID)	Description
HXAF240C-M6SN ¹ (All NVMe)	Cisco HyperFlex HX240 All NVMe server has Small form-factor (SFF) drives, with 24-drive backplane. <ul style="list-style-type: none"> ■ Front-loading drive bays 1–24 support 2.5-inch NVMe (only) drives. ■ No CPU, memory, drives, PCIe cards, or power supply included
HXAF240C-M6SX ¹ (All Flash)	Cisco HyperFlex HX240 All Flash server has Small form-factor (SFF) drives, with 24-drive backplane. <ul style="list-style-type: none"> ■ Front-loading drive bays 1–24 support 2.5-inch SAS/SATA drives. ■ Optionally, front-loading drive bays 1, 2, 3, and 4 support 2.5-inch NVMe SSDs. ■ Optionally, 4 rear facing SAS/SATA/NVMe drives ■ No CPU, memory, drives, PCIe cards, or power supply included
HX240C-M6SX ¹ (Hybrid)	Cisco HyperFlex HX240 Hybrid has Small form-factor (SFF) drives, with 24-drive backplane. <ul style="list-style-type: none"> ■ Front-loading drive bays 1–24 support 2.5-inch SAS/SATA drives. ■ Optionally, 4 rear facing SAS/SATA drives ■ No CPU, memory, drives, PCIe cards, or power supply included

Notes:

1. This product may not be purchased outside of the approved bundles (must be ordered under the MLB)

The Cisco HyperFlex HX240C M6 All NVMe, All Flash and Hybrid server nodes:

- Includes 24 drive backplane.
- Does not include power supply, CPU, memory (DIMMs or PMem), hard disk drives (HDDs), solid-state drives (SSDs), NVMe drives, SD cards, riser 1, riser 2, riser 3, tool-less rail kit, or PCIe cards.

	<p>NOTE:</p> <ul style="list-style-type: none"> ■ Refer to Cisco HyperFlex Drive Compatibility document for future expansion and drive compatibility within the same node and HX cluster. ■ Use the steps on the following pages to configure the server with the components that you want to include.
---	---

STEP 2 SELECT DEPLOYMENT MODE (OPTIONAL)

Starting with HyperFlex 4.5(2a), the following 2 deployment options are supported

Select deployment mode

The available deployment modes are listed in [Table 4](#)

Table 4 Deployment Modes

Product ID (PID)	Description
HX-DC-FI	Deployment mode Selection PID to use Hyperflex with FI
HX-DC-NO-FI	Deployment mode Selection PID to use Hyperflex without FI

- **HX Data Center with Fabric Interconnect** - This deployment option connects the server to Cisco Fabric Interconnect. The installation for this type of deployment can be done using the standalone installer or from the Intersight. This deployment mode has been supported since launch of HyperFlex.
- **HX Data Center without Fabric Interconnect** - This deployment option allows server nodes to be directly connected to existing switches. The installation for this type of deployment can be done from the Intersight only.

Note the following apply:

- No support for SED drives
- No hyper-V support
- No support for PMem
- No support for Additional PCIe Cisco VIC
- No support for stretch cluster
- No support for Application acceleration engine

Selecting this option will hence grey out the unsupported options during ordering



NOTE:

- HX Data Center without Fabric Interconnect (DC-no-FI) All NVMe - HXAF240C-M6SN require HXDP 5.0(1b) or higher.
- If no selection is done, the deployment mode is assumed to be DC with FI.

STEP 3 SELECT RISER CARDS (REQUIRED)

Select risers from [Table 5](#).

Table 5 PIDs of the Risers

Product ID (PID)	Description
HX-RIS1A-240M6 (default riser)	C240 M6 Riser1A (controlled with CPU1) <ul style="list-style-type: none"> ■ PCIe Slot 1 (bottom slot): full height, 3/4 length, x8, NCSI ■ PCIe Slot 2 (middle slot): full height, full length (GPU Card), x16, NCSI ■ PCIe Slot 3 (top slot): full height, full length, x8
HX-RIS1B-240M6 (storage riser)	C240 M6 Riser1B (controlled with CPU1) <ul style="list-style-type: none"> ■ Slot 1 is reserved ■ Slot 2 (middle slot, 2.5" drive bay 102), x4 ■ Slot 3 (top slot, 2.5" drive bay 101), x4
UCSC-RIS2A-240M6 (default riser)	C240 M6 Riser2A (controlled with CPU2) <ul style="list-style-type: none"> ■ Slot 4 (bottom slot): full height, 3/4 length, x8, NCSI ■ Slot 5 (middle slot): full height, full length (GPU Card), x16, NCSI ■ Slot 6 (top slot): full height, full length, x8
HX-RIS3A-240M6 (default riser)	C240 M6 Riser3A (controlled with CPU2) <ul style="list-style-type: none"> ■ Slot 7 (bottom slot): full height, full length, x8 ■ Slot 8 (top slot): full height, full length, x8
HX-RIS3B-240M6 (storage riser)	C240 M6 Riser 3B (controlled with CPU2) <ul style="list-style-type: none"> ■ Slot 7 (bottom slot, 2.5" drive bay 104), x4 ■ Slot 8 (top slot, 2.5" drive bay 103), x4
HX-RIS3C-240M6 (GPU riser)	C240 M6 Riser 3C (controlled with CPU2) <ul style="list-style-type: none"> ■ Slot 7 supports one full-height, full-length, double-wide GPU (PCIe slot 7 only), x16 ■ Slot 8 blocked by double-wide GPU



NOTE:

If there is any PCIe slot that does not have a card installed, you must order a blanking panel for that slot (UCSC-FBRS2-C240M6 = for riser 2 and UCSC-FBRS3-C240M6= for riser 3).

For additional details, see [Riser Card Configuration and Options, page 87](#).

STEP 4 SELECT CPU(s)

The standard CPU features are:

- 3rd Gen Intel® Xeon® Scalable Processors (Ice Lake)
- Intel® C621A series chipset
- Cache size of up to 60 MB
- Up to 40 cores

Select CPUs

The available CPUs are listed in [Table 6](#)

Table 6 Available CPUs

Product ID (PID)	Clock Freq (GHz)	Power (W)	Cache Size (MB)	Cores	UPI ¹ Links (GT/s)	Highest DDR4 DIMM Clock Support (MHz) ²	Support HyperFlex Boost Mode		Support PMem
8000 Series Processors							All Flash	All NVMe	
HX-CPU-I8380	2.3	270	60	40	3 at 11.2	3200	Yes	Yes	Yes
HX-CPU-I8368	2.4	270	57	38	3 at 11.2	3200	Yes	Yes	Yes
HX-CPU-I8362	2.8	265	48	32	3 at 11.2	3200	Yes	Yes	Yes
HX-CPU-I8360Y	2.4	250	54	36	3 at 11.2	3200	Yes	Yes	Yes
HX-CPU-I8358P	2.6	240	48	32	3 at 11.2	3200	Yes	Yes	Yes
HX-CPU-I8358	2.6	250	48	32	3 at 11.2	3200	Yes	Yes	Yes
HX-CPU-I8352Y	2.2	205	48	32	3 at 11.2	3200	Yes	Yes	Yes
HX-CPU-I8352V	2.1	195	54	36	3 at 11.2	2933	Yes	Yes	Yes
HX-CPU-I8352M	2.3	185	48	32	3 at 11.2	2933	Yes	Yes	Yes
HX-CPU-I8352S	2.2	205	48	32	3 at 11.2	3200	Yes	Yes	Yes
HX-CPU-I8351N ³	2.4	225	54	36	0	2933	Yes	Yes	Yes
6000 Series Processors									
HX-CPU-I6354	3.0	205	39	18	3 at 11.2	3200	Yes	Yes	Yes
HX-CPU-I6348	2.6	235	42	28	3 at 11.2	3200	Yes	Yes	Yes
HX-CPU-I6346	3.1	205	36	16	3 at 11.2	3200	Yes	Yes	Yes
HX-CPU-I6342	2.8	230	36	24	3 at 11.2	3200	Yes	Yes	Yes
HX-CPU-I6338N	2.2	185	48	32	3 at 11.2	2666	Yes	Yes	Yes
HX-CPU-I6338T	2.1	165	36	24	3 at 11.2	3200	Yes	Yes	Yes
HX-CPU-I6338	2.0	205	48	32	3 at 11.2	3200	Yes	Yes	Yes
HX-CPU-I6336Y	2.4	185	36	24	3 at 11.2	3200	Yes	Yes	Yes
HX-CPU-I6334	3.6	165	18	8	3 at 11.2	3200	No	No	Yes
HX-CPU-I6330N	2.2	165	42	28	3 at 11.2	2666	Yes	Yes	Yes
HX-CPU-I6330	2.0	205	42	28	3 at 11.2	2933	Yes	Yes	Yes

Table 6 Available CPUs

Product ID (PID)	Clock Freq (GHz)	Power (W)	Cache Size (MB)	Cores	UPI ¹ Links (GT/s)	Highest DDR4 DIMM Clock Support (MHz) ²	Support HyperFlex Boost Mode		Support PMem
HX-CPU-I6326	2.9	185	24	16	3 at 11.2	3200	Yes	Yes	Yes
HX-CPU-I6314U ⁴	2.3	205	48	32	0	3200	Yes	Yes	Yes
HX-CPU-I6312U ⁵	2.4	185	36	24	0	3200	Yes	Yes	Yes
5000 Series Processors									
HX-CPU-I5320T	2.3	150	30	20	3 at 11.2	2933	Yes	Yes	Yes
HX-CPU-I5320	2.2	185	39	26	3 at 11.2	2933	Yes	Yes	Yes
HX-CPU-I5318N	2.1	150	36	24	3 at 11.2	2666	Yes	Yes	Yes
HX-CPU-I5318S	2.1	165	36	24	3 at 11.2	2933	Yes	Yes	Yes
HX-CPU-I5318Y	2.1	165	36	24	3 at 11.2	2933	Yes	Yes	Yes
HX-CPU-I5317	3.0	150	18	12	3 at 11.2	2933	Yes	No	Yes
HX-CPU-I5315Y	3.2	140	12	8	3 at 11.2	2933	No	No	Yes
4000 Series Processors									
HX-CPU-I4316	2.3	150	30	20	2 at 10.4	2666	Yes	Yes	No
HX-CPU-I4314	2.4	135	24	16	2 at 10.4	2666	Yes	Yes	Yes
HX-CPU-I4310T	2.3	105	15	10	2 at 10.4	2666	No	No	No
HX-CPU-I4310	2.1	120	18	12	2 at 10.4	2666	Yes	No	No
HX-CPU-I4309Y	2.8	105	12	8	2 at 10.4	2666	No	No	No

Notes:

1. UPI = Ultra Path Interconnect.
2. If higher or lower speed DIMMs are selected than what is shown in [Table 8 on page 33](#) for a given CPU speed, the DIMMs will be clocked at the lowest common denominator of CPU clock and DIMM clock.
3. The maximum number of HX-CPU-I8351N CPUs is one
4. The maximum number of HX-CPU-I6314U CPUs is one
5. The maximum number of HX-CPU-I6312U CPUs is one



CAUTION: For systems configured with 3rd Gen Intel® Xeon® Scalable Processors (Ice Lake) operating above 28° C [82.4° F], a fan fault or executing workloads with extensive use of heavy instructions sets such as Intel® Advanced Vector Extensions 512 (Intel® AVX-512), may assert thermal and/or performance faults with an associated event recorded in the System Event Log (SEL).

If an NVIDIA A10 or A100 GPU is installed or rear HDDs are installed, the 28° C [82.4° F] restriction changes to 25° C [77° F]

Table 7 CPU Suffixes

CPU Suffix	Description	Features
N	Networking Optimized	Optimized for use in networking applications like L3 forwarding, 5G UPF, OVS DPDK, VPP FIB router, VPP IPsec, web server/NGINX, vEPC, vBNG, and vCMTS. SKUs have higher base frequency with lower TDPs to enable best performance/Watt
P	Cloud Optimized	SKU specifically designed for cloud IaaS environments to deliver higher frequencies at constrained TDPs
V	Cloud Optimized	SKUs specifically designed for cloud environments to deliver high rack density and maximize VM/cores per TCO\$
T	High T case	SKUs designed for Network Environment-Building System (NEBS) environments
U	1-socket Optimized	Optimized for targeted platforms adequately served by the cores, memory bandwidth and IO capacity available from a single processor
S	Max SGX enclave size	Supports Max SGX enclave size (512GB) to enhance and protect the most sensitive portions of a workload or service
M	Media and AI optimized	Media, AI and HPC Segment Optimized for lower TDP & higher frequencies delivering better perf/w
Y	Speed Select - Performance Profile	Intel® Speed Select Technology provides the ability to set a guaranteed base frequency for a specific number of cores, and assign this performance profile to a specific application/workload to guarantee performance requirements. It also provides the ability to configure settings during runtime and provide additional frequency profile configuration opportunities.

Supported Configurations

(1) DIMM only configurations:

- Select one or two identical CPUs listed in [Table 6 Available CPUs, page 27](#)

(2) DIMM/PMem Mixed Configurations:

- You must select two identical CPUs listed in [Table 6 Available CPUs, page 27](#)



NOTE: Data center deployment mode without fabric interconnect (HX-DC-no-FI) does not support Intel® Optane™ Persistent Memory (PMem). Refer to [STEP 2](#) for the details

(3) Configurations with NVMe PCIe drives (either all NVMe drives or mixed NVMe/SAS/SATA):

- You must select two identical CPUs listed in [Table 6 Available CPUs, page 27](#)

(4) One-CPU Configuration:

- Choose one CPU from any one of the rows of [Table 6 Available CPUs, page 27](#)
- HX DC supports single socket configuration
- HX DC supports single socket for 12 core and above



NOTE: HXAF240C-M6SN (All NVMe) server node does not support One-CPU Configuration.

(5) Two-CPU Configuration:

- Choose two identical CPUs from any one of the rows of [Table 6 Available CPUs, page 27](#)



NOTE:

- You cannot have two I8351N or two I6314U or I6312U CPUs in a two-CPU configuration.
 - If you configure a server with one I8351N CPU or one I6314U CPU or one I6312U CPU you cannot later upgrade to a 2-CPU system with two of these CPUs.
-

(6) For the HXAF240C-M6SN (All NVMe) server node:

- You must select two identical CPUs listed in [Table 6 Available CPUs, page 27](#).
- Dual socket is required with All NVMe server

Caveats

- The selection of 1 or 2 CPUs depends on the desired server functionality. See the following sections:
 - [STEP 5 SELECT MEMORY, page 32](#)
 - [STEP 6 SELECT DRIVE CONTROLLERS, page 38](#)
 - [STEP 7 SELECT DRIVES, page 39](#)
 - [STEP 8 SELECT HYPERFLEX CONNECTIVITY MODE, page 48](#)

STEP 5 SELECT MEMORY

The available memory main characteristics for the HX240C M6 All NVMe/All Flash/Hybrid Server Nodes are as follows:

- Clock speed: 3200 MHz
- Ranks per DIMM: 1, 2, 4, or 8
- Operational voltage: 1.2 V
- Registered ECC DDR4 DIMMs (RDIMMs), Load-reduced DIMMs (LRDIMMs), or Intel® Optane™ Persistent Memory Modules (PMem).

Memory is organized with eight memory channels per CPU, with up to two DIMMs per channel, as shown in [Figure 8](#).

Figure 8 HX240C M6 All NVMe/All Flash/Hybrid Server Nodes Memory Organization

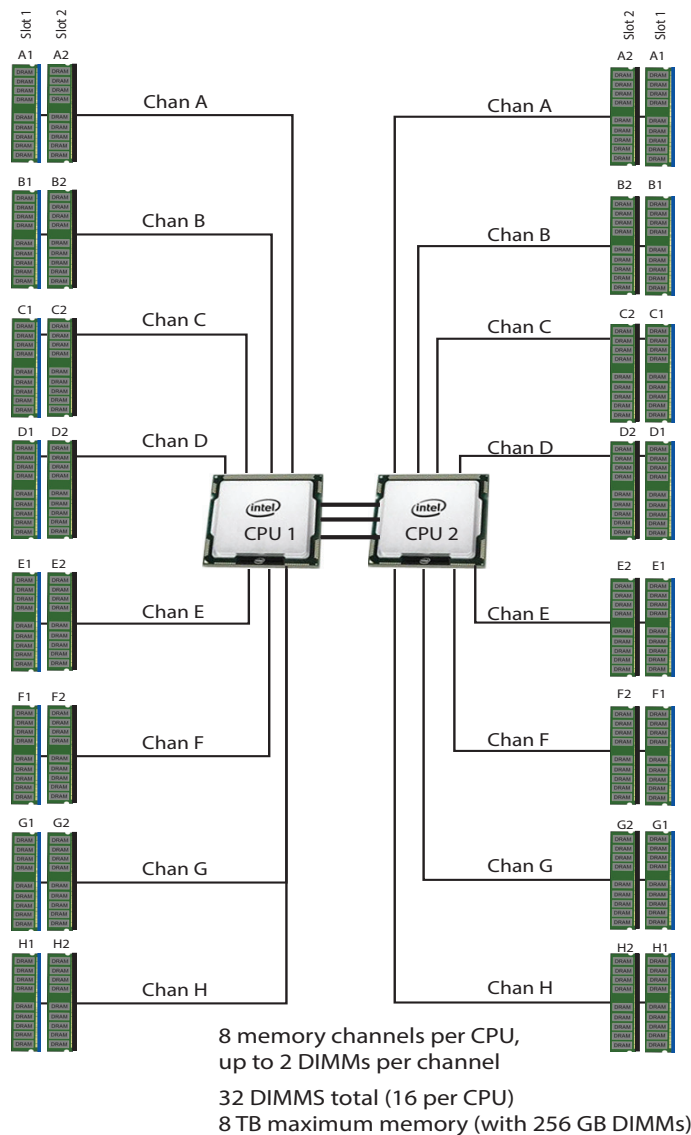

Select DIMMs and PMem

The available memory DIMMs, PMem and Memory Mode option are listed in [Table 8](#).

Table 8 Available DDR4 DIMMs and PMem

Product ID (PID)	PID Description	Voltage	Ranks /DIMM
3200-MHz DIMMs			
HX-MR-X16G1RW	16 GB RDIMM SRx4 3200 (8Gb)	1.2 V	1
HX-MR-X32G1RW	32 GB RDIMM SRx4 3200 (16Gb)	1.2 V	1
HX-MR-X32G2RW	32 GB RDIMM DRx4 3200 (8Gb)	1.2 V	2
HX-MR-X64G2RW	64 GB RDIMM DRx4 3200 (16Gb)	1.2 V	2
HX-ML-128G4RW	128 GB LRDIMM QRx4 3200 (16Gb) (non 3DS)	1.2 V	4
HX-ML-256G8RW ^{1,2}	256 GB LRDIMM 8Rx4 3200 (16Gb) (3DS)	1.2 V	8
Intel® Optane™ Persistent Memory (PMem)			
HX-MP-128GS-B0	Intel® Optane™ Persistent Memory, 128GB, 3200 MHz		
HX-MP-256GS-B0	Intel® Optane™ Persistent Memory, 256 GB, 3200 MHz		
HX-MP-512GS-B0	Intel® Optane™ Persistent Memory, 512 GB, 3200 MHz		
DIMM Blank³			
UCS-DIMM-BLK	UCS DIMM Blank		
Intel® Optane™ Persistent Memory (PMem) Operational Modes			
HX-DCPMM-AD ⁴	Intel Optane DC Persistent Memory Operational Mode - App Di		
HX-DCPMM-MM ⁵	Intel Optane DC Persistent Memory Operational Mode - Memory		

Notes:

- 256 GB DIMM is available on HX240M6 server models, with the exclusion of HX240M6 LFF model.
- 256 GB DIMMs cannot be combined with GPU cards, and the ambient temperature shall be limited to a maximum of 28°C.
- Any empty DIMM slot must be populated with a DIMM blank to maintain proper cooling airflow.
- App Direct Mode:** PMem operates as a solid-state disk storage device. Data is saved and is non-volatile. Both PMem and DIMM capacities count towards the CPU capacity limit.
- Memory Mode:**
 - Please note that DCPMM - Memory mode configuration is on compliance hold review. Please contact: hxdcpmm_compliancehold@cisico.com
 - Please use the [HX M6 Memory Guide](#) to determine the correct DRAM:DCPMM ratio



Data Center Deployment Mode

NOTE: Data center deployment mode without fabric interconnect (HX-DC-no-FI) does not support HX-MP-512GS-A0, HX-MP-256GS-A0, HX-MP-128GS-A0, HX-DCPMM-AD and HX-DCPMM-MM. Refer to [STEP 2](#) for the details

**NOTE:**

- System performance is optimized when the DIMM type and quantity are equal for both CPUs, and when all channels are filled equally across the CPUs in the server.
 - The selected DIMMs must be all of same type and number of DIMMs must be equal for both CPUs
 - HyperFlex Data Platform reserves memory for each controller VM. Refer to the <[Install Guide](#)> for reservation details.
 - The memory mirroring feature is not supported with HyperFlex nodes.
-

Memory Configurations, Features, and Modes

System speed is dependent on the CPU DIMM speed support. Refer to [Available CPUs, page 27](#) for DIMM speeds.

- The server supports the following memory reliability, availability, and serviceability (RAS) BIOS options (only one option can be chosen):
 - Adaptive Double Device Data Correction (ADDDC) (default)
 - Maximum performance
- For best performance, observe the following:
 - When one DIMM is used, it must be populated in DIMM slot 1 (farthest away from the CPU) of a given channel.
 - When single- or dual-rank DIMMs are populated in two DIMMs per channel (2DPC) configurations, always populate the higher number rank DIMM first (starting from the farthest slot). For a 2DPC example, first populate with dual-rank DIMMs in DIMM slot 1. Then populate single-rank DIMMs in DIMM 2 slot.
- DIMMs for CPU 1 and CPU 2 (when populated) must always be configured identically.
- Cisco memory from previous generation servers (DDR3 and DDR4) is not compatible with the server.
- Memory can be configured in any number of DIMMs as pairs, although for optimal performance, see the following document
[HX M6 Memory Guide](#)

Approved Configurations

(1) 1-CPU configuration:

- Select from 1 to 16 DIMMs
 - 1, 2, 4, 6, 8, 12, or 16 DIMMs allowed
 - 3, 5, 7, 9, 10, 11, 13, 14, 15 DIMMs not allowed
 - DIMMs for both CPUs must be configured identically.

The DIMMs will be placed by the factory as shown in the following table.

#DIMMs	CPU 1 DIMM Placement in Channels (for identically ranked DIMMs)
1	(A1)
2	(A1, E1)
4	(A1, C1); (E1, G1)
6	(A1, C1); (D1, E1); (G1, H1)
8	(A1, C1); (D1, E1); (G1, H1); (B1, F1)
12	(A1, C1); (D1, E1); (G1, H1); (A2, C2); (D2, E2); (G2, H2)
16	(A1, B1); (C1, D1); (E1, F1); (G1, H1); (A2, B2); (C2, D2); (E2, F2); (G2, H2)

(2) 2-CPU configuration:

- Select from 1 to 16 DIMMs per CPU
 - 1, 2, 4, 6, 8, 12, or 16 DIMMs allowed
 - 3, 5, 7, 9, 10, 11, 13, 14, 15 DIMMs not allowed
 - DIMMs for both CPUs must be configured identically.

The DIMMs will be placed by the factory as shown in the following table.

#DIMMs	CPU 1 DIMM Placement in Channels (for identically ranked DIMMs)	CPU 2 DIMM Placement in Channels (for identically ranked DIMMs)
1	(A1)	(A1)
2	(A1, E1)	(A1, E1)
4	(A1, C1); (E1, G1)	(A1, C1); (E1, G1)
6	(A1, C1); (D1, E1); (G1, H1)	(A1, C1); (D1, E1); (G1, H1)
8	(A1, C1); (D1, E1); (G1, H1); (B1, F1)	(A1, C1); (D1, E1); (G1, H1); (B1, F1)
12	(A1, C1); (D1, E1); (G1, H1); (A2, C2); (D2, E2); (G2, H2)	(A1, C1); (D1, E1); (G1, H1); (A2, C2); (D2, E2); (G2, H2)
16	(A1, B1); (C1, D1); (E1, F1); (G1, H1); (A2, B2); (C2, D2); (E2, F2); (G2, H2)	(A1, B1); (C1, D1); (E1, F1); (G1, H1); (A2, B2); (C2, D2); (E2, F2); (G2, H2)



NOTE: System performance is optimized when the DIMM type and quantity are equal for both CPUs, and when all channels are filled equally across the CPUs in the server.

Table 9 3200-MHz DIMM Memory Speeds with Different Intel® Xeon® Ice Lake® Processors

DIMM and CPU Frequencies (MHz)	DPC	LRDIMM (8Rx4)-256 GB (MHz)	LRDIMM (4Rx4)-128 GB (MHz)	RDIMM (2Rx4) - 64 GB (MHz)	RDIMM (2Rx4) - 32 GB (MHz)	RDIMM (1Rx4) - 16 GB (MHz)
		1.2 V	1.2 V	1.2 V	1.2 V	1.2 V
DIMM = 3200 CPU = 3200	1DPC	3200	3200	3200	3200	3200
	2DPC	3200	3200	3200	3200	3200
DIMM = 3200 CPU = 2933	1DPC	2933	2933	2933	2933	2933
	2DPC	2933	2933	2933	2933	2933
DIMM = 3200 CPU = 2666	1DPC	2666	2666	2666	2666	2666
	2DPC	2666	2666	2666	2666	2666

DIMM Rules

- Allowed DIMM count for 1 CPU:
 - Minimum DIMM count = 1; Maximum DIMM count = 16
 - 1, 2, 4, 6, 8, 12, or 16 DIMMs allowed
 - 3, 5, 7, 9, 10, 11, 13, 14, or 15 DIMMs not allowed.
- Allowed DIMM count for 2 CPUs:
 - Minimum DIMM count = 2; Maximum DIMM count = 32
 - 2, 4, 8, 12, 16, 24, or 32 DIMMs allowed
 - 6, 10, 14, 18, 20, 22, 26, 28, or 30 DIMMs not allowed.
- DIMM Mixing:
 - Mixing different types of DIMM (RDIMM with any type of LRDIMM or 3DS LRDIMM with non-3DS LRDIMM) is not supported within a server.
 - Mixing RDIMM with RDIMM types is allowed if they are mixed in same quantities, in a balanced configuration.
 - Mixing 16 GB, 32 GB, and 64 GB RDIMMs is supported.
 - 128 GB and 256 GB LRDIMMs cannot be mixed with other RDIMMs
 - 128 GB non-3DS LRDIMMs cannot be mixed with 256 GB 3DS LRDIMMs

**NOTE:**

- DIMM mixing is not allowed when PMem are installed; in these cases, all DIMMs must be the same type and size.
 - See the detailed mixing DIMM configurations at the following link
[HX M6 Memory Guide](#)
-

STEP 6 SELECT DRIVE CONTROLLERS

The following list summarizes how drives are controlled on the server:

- SAS/SATA drives are controlled through one or two Cisco 12G SAS pass-through HBAs.
- PCIe drives are controlled directly from the CPUs.



NOTE: Drive Controller are not supported in HXAF240C-M6SN (All NVMe) server node.

Cisco 12G SAS HBA

This HBA supports up to 16 SAS or SATA drives (HX240C-M6SX and HXAF240C-M6SX servers has 24 front drives and 2 or 4 rear drives) operating at 3 Gbs, 6 Gbs, and 12Gbs. It supports JBOD or pass-through mode (not RAID) and plugs directly into the drive backplane. Two of these controllers are required to control 24 front drives and 2 or 4 rear drives.

Select Drive Controller Options

Select the following:

- Cisco 12G SAS HBA (see [Table 10](#)).

Table 10 Hardware Controller Options

Product ID (PID)	PID Description
Controllers for Internal Drives	
Note that if a Cisco 12G SAS HBA is selected, it is factory-installed in the drive backplane connector.	
HX-SAS-240M6 ¹	Cisco 12G SAS HBA (for All Flash and Hybrid server nodes) <ul style="list-style-type: none"> ■ Supports up to 16 internal SAS HDDs and SAS/SATA SSDs ■ Supports JBOD or pass-through mode

Notes:

1. Two of these controllers are required to control 24 front drives and four rear drives.

Approved Configurations

The HX240C M6 All NVMe/All Flash/Hybrid Server Nodes can be ordered as follows:

- HXAF240C-M6SN (24-drive NVMe (only) drives)
- HXAF240C-M6SX (24-drive SAS/SATA backplane and optionally 4 of those can be NVMe)
- HX240C-M6SX (24-drive SAS/SATA backplane)
- There is no RAID support for NVMe drives.

STEP 7 SELECT DRIVES

The standard disk drive features are:

- 2.5-inch small form factor
- Hot-pluggable
- Drives come mounted in sleds

Select Drives - HXAF240C-M6SN (All NVMe)

The available drives are listed in [Table 11](#).



Data Center Deployment Mode

NOTE: HX Data Center without Fabric Interconnect (DC-no-FI) All NVMe - HXAF240C-M6SN require HXDP 5.0(1b) or higher.



* NOTE:

- HX 5.0(2b) supports the ability to handle inter-operability of mixed cache drives on HyperFlex All NVMe clusters with certain hardware configurations:
 - Existing cluster with 375G cache can be expanded with 1.6TB cache.
 - New cluster creation with heterogeneous cache drives needs two-step approach for a minimum of 4 node cluster; (Step 1) cluster creation with minimum three of lesser capacity 375GB cache, (Step 2) cluster expansion with 1.6TB cache. New heterogeneous cluster with less than three 375GB cache is not supported; Upgrade to homogenous cluster with 1.6TB cache is recommended in this scenario.
- For expansion of existing clusters or general information about interoperability of different drives, see [Cisco HyperFlex Drive Compatibility](#).

Table 11 Available Hot-Pluggable Sled-Mounted Drives

Product ID (PID)	PID Description	Drive Type	Capacity
Front Capacity Drive			
HX-NVME4-1920	1.9TB 2.5in U.2 15mm P5520 Hg Perf Med End NVMe (HyperFlex Release 5.0(2b) and later)	NVMe	1.9 TB
HX-NVME4-3840	3.8TB 2.5in U.2 15mm P5520 Hg Perf Med End NVMe (HyperFlex Release 5.0(2b) and later)	NVMe	3.8 TB
HX-NVME4-7680	7.6TB 2.5in U.2 15mm P5520 Hg Perf Med End NVMe (HyperFlex Release 5.0(2b) and later)	NVMe	7.6 TB
HX-NVMEI4-I1920	1.9TB 2.5in U.2 Intel P5500 NVMe High Perf Medium Endurance	NVMe	1.9 TB
HX-NVMEI4-I3840	3.8TB 2.5in U.2 Intel P5500 NVMe High Perf Medium Endurance	NVMe	3.8 TB
HX-NVMEI4-I7680	7.6TB 2.5in U.2 Intel P5500 NVMe High Perf Medium Endurance	NVMe	7.6 TB

Table 11 Available Hot-Pluggable Sled-Mounted Drives

Product ID (PID)	PID Description	Drive Type	Capacity
HX-NVMEM6-W15300	15.3TB 2.5in U.2 WD SN840 NVMe Extreme Perf. High Endurance (HyperFlex Release 5.0 (2a) and later)	NVMe	15.3 TB
HX-NVME4-15360	15.3TB 2.5in U.2 15mm P5520 Hg Perf Med End NVMe (HyperFlex Release 5.0 (2b + Catalog) and later)	NVMe	15.3 TB
Rear Capacity Drive			
HX-NVME4-1920	1.9TB 2.5in U.2 15mm P5520 Hg Perf Med End NVMe (HyperFlex Release 5.0(2b) and later)	NVMe	1.9 TB
HX-NVME4-3840	3.8TB 2.5in U.2 15mm P5520 Hg Perf Med End NVMe (HyperFlex Release 5.0(2b) and later)	NVMe	3.8 TB
HX-NVME4-7680	7.6TB 2.5in U.2 15mm P5520 Hg Perf Med End NVMe (HyperFlex Release 5.0(2b) and later)	NVMe	7.6 TB
HX-NVMEI4-I1920	1.9TB 2.5in U.2 Intel P5500 NVMe High Perf Medium Endurance	NVMe	1.9 TB
HX-NVMEI4-I3840	3.8TB 2.5in U.2 Intel P5500 NVMe High Perf Medium Endurance	NVMe	3.8 TB
HX-NVMEI4-I7680	7.6TB 2.5in U.2 Intel P5500 NVMe High Perf Medium Endurance	NVMe	7.6 TB
HX-NVMEM6-W15300	15.3TB 2.5in U.2 WD SN840 NVMe Extreme Perf. High Endurance (HyperFlex Release 5.0 (2a) and later)	NVMe	15.3 TB
HX-NVME4-15360	15.3TB 2.5in U.2 15mm P5520 Hg Perf Med End NVMe (HyperFlex Release 5.0 (2b + Catalog) and later)	NVMe	15.3 TB
Front Cache Drive			
HX-NVMEXPB-I375*	375GB 2.5in Intel Optane NVMe Extreme Performance SSD (Mixed drive support with HyperFlex Release 5.0(2b))	NVMe	375 GB
HX-NVMEXP-I400	400GB 2.5in U.2 15mm P5800X Optane Ext Perf NVMe (30/100X) (HyperFlex Release 5.0(2b) and later)	NVMe	400 GB
HX-NVMEM6-W1600*	1.6TB 2.5in U.2 WD SN840 NVMe Extreme Perf. High Endurance (HyperFlex Release 5.0(2b); Mixed drive support available)	NVMe	1.6 TB
Front System Drive			
HX-NVME2H-I1000	Cisco 2.5" U.2 1,0 TB Intel P4510 NVMe High Perf. Value Endurance	NVMe	1.0 TB
HX-NVME4-1920	1.9TB 2.5in U.2 15mm P5520 Hg Perf Med End NVMe (HyperFlex Release 5.0(2b) and later)	NVMe	1.9 TB
Boot Drive			
HX-M2-240GB	240GB SATA M.2	SATA	240 GB
HX-M2-HWRAID	Cisco Boot optimized M.2 Raid controller		

Approved Configurations

- Capacity drive:
 - **I/O Centric:** Six to twenty-two front capacity drives
 - **Storage Centric:** Six to twenty-four (twenty-two front + two rear) capacity drives
-

**NOTE:**

- For cluster scale related information please see the product [release notes](#).
-

- One cache drive
 - One system drive
 - Boot drive:
-

**NOTE:**

- Order two identical M.2 SATA SSDs for the boot-optimized RAID controller. You cannot mix M.2 SATA SSD capacities.
 - It is recommended that M.2 SATA SSDs be used as boot-only devices.
 - The Boot-Optimized RAID controller supports VMWare, Windows and Linux Operating Systems.
 - CIMC/UCSM is supported for configuring of volumes and monitoring of the controller and installed SATA M.2 drives.
 - The minimum version of Cisco IMC and Cisco UCS Manager that supports this controller is 4.2(1) and later. The name of the controller in the software is MSTOR-RAID
 - The SATA M.2 drives can boot in UEFI mode only. Legacy boot mode is not supported.
 - Hot-plug replacement is not supported. The server must be powered off.
 - The boot-optimized RAID controller is supported when the server is used as a compute node in HyperFlex configurations.
 - See [Figure 16 on page 83](#) for the location of the module connector on the motherboard. This connector accepts the boot-optimized RAID controller.
-

Caveats

- **SED** drives are not supported with HXAF240C-M6SN (All NVMe) server node.
- **SFF NVMe** drives are connected directly to CPU2, and are not managed by any drive controller.

Select Drives - HXAF240C-M6SX (All Flash)

The available drives are listed in [Table 12](#).



Data Center Deployment Mode

NOTE: Data center deployment mode without fabric interconnect (HX-DC-no-FI) does not support SED drives. Refers to [STEP 2](#) for the details.



* NOTE:

- HX 5.0(2b) supports the ability to handle inter-operability of mixed cache drives on HyperFlex All Flash clusters with certain hardware configurations:
 - Existing cluster with 375G cache can be expanded with 1.6TB cache.
 - New cluster creation with heterogeneous cache drives needs two-step approach for a minimum of 4 node cluster; (Step 1) cluster creation with minimum three of lesser capacity 375GB cache, (Step 2) cluster expansion with 1.6TB cache. New heterogeneous cluster with less than three 375GB cache is not supported; Upgrade to homogenous cluster with 1.6TB cache is recommended in this scenario.
- For expansion of existing clusters or general information about interoperability of different drives, see [Cisco HyperFlex Drive Compatibility](#).

Table 12 Available Hot-Pluggable Sled-Mounted Drives

Product ID (PID)	PID Description	Drive Type	Capacity
Front Capacity Drive			
HX-SD19T61X-EV	1.9TB 2.5 inch Enterprise Value 6G SATA SSD	SATA	1.9 TB
HX-SD38T61X-EV	3.8TB 2.5 inch Enterprise Value 6G SATA SSD	SATA	3.8 TB
HX-SD76T61X-EV	7.6TB 2.5 inch Enterprise Value 6G SATA SSD	SATA	7.6 TB
HX-SD960G6S1X-EV	960GB 2.5 inch Enterprise Value 6G SATA SSD (HyperFlex Release (5.0(1c) and later)	SATA	960 GB
HX-SD19T6S1X-EV	1.9TB 2.5 inch Enterprise Value 6G SATA SSD (HyperFlex Release (5.0(1c) and later)	SATA	1.9 TB
HX-SD38T6S1X-EV	3.8TB 2.5 inch Enterprise Value 6G SATA SSD (HyperFlex Release (5.0(1c) and later)	SATA	3.8 TB
HX-SD76T6S1X-EV	7.6TB 2.5 inch Enterprise Value 6G SATA SSD (HyperFlex Release (5.0(1c) and later)	SATA	7.6 TB
Rear Capacity Drive			
HX-SD19T61X-EV	1.9TB 2.5 inch Enterprise Value 6G SATA SSD	SATA	1.9 TB
HX-SD38T61X-EV	3.8TB 2.5 inch Enterprise Value 6G SATA SSD	SATA	3.8 TB
HX-SD76T61X-EV	7.6TB 2.5 inch Enterprise Value 6G SATA SSD	SATA	7.6 TB

Table 12 Available Hot-Pluggable Sled-Mounted Drives (continued)

Product ID (PID)	PID Description	Drive Type	Capacity
HX-SD960G6S1X-EV	960GB 2.5 inch Enterprise Value 6G SATA SSD (HyperFlex Release (5.0(1c) and later)	SATA	960 GB
HX-SD19T6S1X-EV	1.9TB 2.5 inch Enterprise Value 6G SATA SSD (HyperFlex Release (5.0(1c) and later)	SATA	1.9 TB
HX-SD38T6S1X-EV	3.8TB 2.5 inch Enterprise Value 6G SATA SSD (HyperFlex Release (5.0(1c) and later)	SATA	3.8 TB
HX-SD76T6S1X-EV	7.6TB 2.5 inch Enterprise Value 6G SATA SSD (HyperFlex Release (5.0(1c) and later)	SATA	7.6 TB
Front SED Capacity Drive			
HX-SD960GBM2NK9	960GB Enterprise value SATA SSD (1X, SED)	SATA	960 GB
HX-SD38TBEM2NK9	3.8TB Enterprise value SATA SSD (1X, SED)	SATA	3.8 TB
HX-SD76TBEM2NK9	7.6TB Enterprise value SATA SSD (1X, SED)	SATA	7.6 TB
HX-SD960GBKNK9	960GB Enterprise Value SAS SSD (1X FWPD, SED)	SAS	960 GB
HX-SD38TBKNK9	3.8TB Enterprise Value SAS SSD (1X FWPD, SED)	SAS	3.8 TB
HX-SD76TBKNK9	7.6TB Enterprise value SAS SSD (1 DWPD, SED-FIPS)	SAS	7.6 TB
Rear SED Capacity Drive			
HX-SD960GBM2NK9	960GB Enterprise value SATA SSD (1X, SED)	SATA	960 GB
HX-SD38TBEM2NK9	3.8TB Enterprise value SATA SSD (1X, SED)	SATA	3.8 TB
HX-SD76TBEM2NK9	7.6TB Enterprise value SATA SSD (1X, SED)	SATA	7.6 TB
HX-SD960GBKNK9	960GB Enterprise Value SAS SSD (1X FWPD, SED)	SAS	960 GB
HX-SD38TBKNK9	3.8TB Enterprise Value SAS SSD (1X FWPD, SED)	SAS	3.8 TB
HX-SD76TBKNK9	7.6TB Enterprise value SAS SSD (1 DWPD, SED-FIPS)	SAS	7.6 TB
Front Cache Drive			
HX-NVMEXPB-I375*	375GB 2.5in Intel Optane NVMe Extreme Performance SSD (Mixed drive support with HyperFlex Release 5.0(2b))	NVMe	375 GB
HX-NVMEXP-I400	400GB 2.5in U.2 15mm P5800X Optane Ext Perf NVMe (30/100X) (HyperFlex Release 5.0(2b) and later)	NVMe	400 GB
HX-NVMEM6-W1600*	1.6TB 2.5in U.2 WD SN840 NVMe Extreme Perf. High Endurance (HyperFlex Release 5.0(2b); Mixed drive support available)	NVMe	1.6 TB
HX-SD800GK3X-EP	800GB 2.5in Enterprise Performance 12G SAS SSD(3X endurance)	SAS	800 GB
Front SED Cache Drive			
HX-SD800GBKNK9	800GB Enterprise Performance SAS SSD (3X FWPD, SED)	SAS	800 GB
Front System Drive			
HX-SD240GM1X-EV	240GB 2.5 inch Enterprise Value 6G SATA SSD	SATA	240 GB
Boot Drive			
HX-M2-240GB	240GB SATA M.2	SATA	240 GB

Table 12 Available Hot-Pluggable Sled-Mounted Drives (*continued*)

Product ID (PID)	PID Description	Drive Type	Capacity
HX-M2-HWRAID	Cisco Boot optimized M.2 Raid controller		
NOTE: Cisco uses solid state drives (SSDs) from a number of vendors. All solid state drives (SSDs) are subject to physical write limits and have varying maximum usage limitation specifications set by the manufacturer. Cisco will not replace any solid state drives (SSDs) that have exceeded any maximum usage specifications set by Cisco or the manufacturer, as determined solely by Cisco.			

Approved Configurations

- Capacity drive:
 - I/O Centric: Six to twenty-two front capacity drives
 - Storage Centric: Six to twenty-six (twenty-two front + four rear) capacity drive
 - DC-no-FI: Both I/O Centric and Storage Centric is supported
-



NOTE:

- Rear drives can only be selected once after the front drive slots are filled.
 - Less than six capacity drives is supported only for HX Edge configuration.
 - For cluster scale related information please see the product [release notes](#).
-

- One cache drive
-



NOTE:

- SED cache drive can only be selected, if you have selected SED capacity drive
 - When configuring front facing drives with NVMe drives, you must order an NVMe cable (PID = CBL-FNVMe-240M6) along with the drives.
-

- One system drive
 - One boot drive
-



NOTE:

- Order two identical M.2 SATA SSDs for the boot-optimized RAID controller. You cannot mix M.2 SATA SSD capacities.
 - It is recommended that M.2 SATA SSDs be used as boot-only devices.
 - The Boot-Optimized RAID controller supports VMWare, Windows and Linux Operating Systems.
 - CIMC/UCSM is supported for configuring of volumes and monitoring of the controller and installed SATA M.2 drives.
 - The minimum version of Cisco IMC and Cisco UCS Manager that supports this controller is 4.2(1) and later. The name of the controller in the software is MSTOR-RAID
 - The SATA M.2 drives can boot in UEFI mode only. Legacy boot mode is not supported.
 - Hot-plug replacement is not supported. The server must be powered off.
 - The boot-optimized RAID controller is supported when the server is used as a compute node in HyperFlex configurations.
 - See [Figure 16 on page 83](#) for the location of the module connector on the motherboard. This connector accepts the boot-optimized RAID controller.
-

Caveats

- SED drives can not be mixed with the non-SED drives.

Select Drives - HX240C-M6SX (Hybrid)

The available drives are listed in [Table 13](#).



Data Center Deployment Mode

NOTE: Data center deployment mode without fabric interconnect (HX-DC-no-FI) does not support SED cache drives. Refers to [STEP 2](#) for the details.

Table 13 Available Hot-Pluggable Sled-Mounted Drives

Product ID (PID)	PID Description	Drive Type	Capacity
Front Capacity Drive			
HX-HD12TB10K12N	1.2TB 12G SAS 10K RPM SFF HDD	SAS	1.2 TB
HX-HD18TB10K4KN	1.8TB 12G SAS 10K RPM SFF HDD (4K)	SAS	1.8 TB
HX-HD24TB10K4KN	2.4TB 12G SAS 10K RPM SFF HDD (4K)	SAS	2.4 TB
Rear Capacity Drive			
HX-HD12TB10K12N	1.2TB 12G SAS 10K RPM SFF HDD	SAS	1.2 TB
HX-HD18TB10K4KN	1.8TB 12G SAS 10K RPM SFF HDD (4K)	SAS	1.8 TB
HX-HD24TB10K4KN	2.4TB 12G SAS 10K RPM SFF HDD (4K)	SAS	2.4 TB
Front SED Capacity Drive			
HX-HD12T10NK9	1.2TB 12G SAS 10K RPM SFF HDD (SED)	SAS	1.2 TB
HX-HD24T10NK9	2.4 TB 12G SAS 10K RPM SFF HDD (4K) SED	SAS	2.4 TB
Rear SED Capacity Drive			
HX-HD12T10NK9	1.2TB 12G SAS 10K RPM SFF HDD (SED)	SAS	1.2 TB
HX-HD24T10NK9	2.4 TB 12G SAS 10K RPM SFF HDD (4K) SED	SAS	2.4 TB
Front Cache Drive			
HX-SD16TK3X-EP	1.6TB 2.5in Enterprise Performance 12G SAS SSD(3X endurance)	SAS	1.6 TB
Front SED Cache Drive			
HX-SD16TBKNK9	1.6TB Enterprise performance SAS SSD (3X FWPD, SED)	SAS	1.6 TB
Front System Drive			
HX-SD240GM1X-EV	240GB 2.5 inch Enterprise Value 6G SATA SSD	SATA	240 GB
Boot Drives			
HX-M2-240GB	240GB SATA M.2	SATA	240 GB
HX-M2-HWRAID	Cisco Boot optimized M.2 Raid controller		
<p>NOTE: Cisco uses solid state drives (SSDs) from a number of vendors. All solid state drives (SSDs) are subject to physical write limits and have varying maximum usage limitation specifications set by the manufacturer. Cisco will not replace any solid state drives (SSDs) that have exceeded any maximum usage specifications set by Cisco or the manufacturer, as determined solely by Cisco.</p>			

Approved Configurations

- Capacity drive:
 - **I/O Centric:** Six to twenty-two front capacity drives
 - **Storage Centric:** Six to twenty-six (twenty two front + four rear) capacity drives
 - **DC-no-FI:** Both I/O Centric and Storage Centric is supported



NOTE:

- Rear drives can only be selected once after the front drive slots are filled
- Less than six capacity drives is supported only for HX Edge configuration.
- For cluster scale related information please see the product [release notes](#).
- All SED HDDs are FIPs 140-2 compliant

- One cache drive



NOTE:

- **SED** cache drive can only be selected if you have selected **SED** capacity drives

- One system drive

- One boot drive



NOTE:

- Order two identical M.2 SATA SSDs for the boot-optimized RAID controller. You cannot mix M.2 SATA SSD capacities.
- It is recommended that M.2 SATA SSDs be used as boot-only devices.
- The Boot-Optimized RAID controller supports VMWare, Windows and Linux Operating Systems.
- CIMC/UCSM is supported for configuring of volumes and monitoring of the controller and installed SATA M.2 drives.
- The minimum version of Cisco IMC and Cisco UCS Manager that supports this controller is 4.2(1) and later. The name of the controller in the software is MSTOR-RAID.
- The SATA M.2 drives can boot in UEFI mode only. Legacy boot mode is not supported.
- Hot-plug replacement is not supported. The server must be powered off.
- The boot-optimized RAID controller is supported when the server is used as a compute node in HyperFlex configurations.
- See [Figure 16 on page 83](#) for the location of the module connector on the motherboard. This connector accepts the boot-optimized RAID controller.

Caveats

- **SED** drives can not be mixed with the **non-SED** drives.

STEP 8 SELECT HYPERFLEX CONNECTIVITY MODE

Starting with HyperFlex 5.0(2a), the following two Connectivity options are supported

Select Connectivity mode

The available connectivity modes are listed in [Table 14](#)

Table 14 Connectivity Modes

Product ID (PID)	Description
HX-VIC-MODE	Hyperflex VIC Connectivity Mode
HX-NIC-MODE ¹	Hyperflex NIC Connectivity Mode

Notes:

1. Selection of Deployment Mode Option (HX-DC-NO-FI) is required for the NIC Connectivity Mode. Minimum 4 NIC Ports required, If NIC mode is selected and Double-Wide GPU is selected from R2 Slot5 x16, then must select quad port PID from R2 Slot 4 x8 PCIe NIC option and cannot make selection from R2 Slot 6 x8 PCIe NIC Option.

Table 15 Available Cards for the Connectivity Modes

Product ID (PID)	Description
HyperFlex VIC Connectivity Mode	
HX-M-V25-04	Cisco UCS VIC 1467 quad port 10/25G SFP28 mLOM
HX-M-V100-04	Cisco UCS VIC 1477 dual port 40/100G QSFP28 mLOM
HyperFlex NIC Connectivity Mode	
R2 Slot 4 x8 PCIe NIC	
HX-PCIE-ID10GF	Intel X710 dual-port 10G SFP+
HX-PCIE-IQ10GF	Intel X710 quad-port 10G SFP+ NIC
HX-P-I8D25GF	Cisco-Intel E810XXVDA2 2x25/10 GbE SFP28 PCIe NIC
HX-P-I8Q25GF	Cisco-Intel E810XXVDA4L 4x25/10 GbE SFP28 PCIe NIC
R2 Slot 6 x8 PCIe NIC	
HX-PCIE-ID10GF	Intel X710 dual-port 10G SFP+
HX-PCIE-IQ10GF	Intel X710 quad-port 10G SFP+ NIC
HX-P-I8D25GF	Cisco-Intel E810XXVDA2 2x25/10 GbE SFP28 PCIe NIC
HX-P-I8Q25GF	Cisco-Intel E810XXVDA4L 4x25/10 GbE SFP28 PCIe NIC

STEP 9 SELECT OPTION CARD(S)

The standard PCIe card offerings are:

- Modular LAN on Motherboard (mLOM)
- Virtual Interface Cards (VICs)
- Network Interface Cards (NICs)

Select Option Cards

The available option cards are listed in [Table 16](#)



Data Center Deployment Mode

NOTE:

- Data center deployment mode without fabric interconnect (HX-DC-no-FI) does not support HX-PCIE-C25Q-04 and HX-PCIE-OFFLOAD-1. Refer to [STEP 2](#) for the details.
- HX-M-V100-04 require HXDP 4.5(2c) or higher for data center deployment mode without fabric interconnect (DC-no-FI).

Table 16 Available PCIe Option Cards

Product ID (PID)	PID Description	Location	Card Size ¹
Virtual Interface Card (VICs)			
HX-PCIE-C100-04	Cisco UCS VIC 1495 dual port 40/100G QSFP28 CNA PCIe	Riser 1 or 2	HHHL, SS
HX-PCIE-C25Q-04	Cisco UCS VIC 1455 quad port 10/25G SFP28 PCIe	Riser 1 or 2	HHHL, SS
Network Interface Cards (NICs)			
1 Gb NICs			
HX-PCIE-IRJ45	Intel i350 quad port 1G copper PCIe	Riser 1, 2, or 3	HHHL, SS
10 Gb NICs			
HX-PCIE-ID10GF	Intel X710-DA2 dual port 10Gb SFP+ NIC	Riser 1, 2, or 3	HHHL, SS
HX-PCIE-IQ10GF	Intel X710 quad port 10G SFP+ NIC	Riser 1, 2, or 3	HHHL, SS
HX-P-ID10GC	Cisco-Intel X710T2LG 2x10 GbE RJ45 PCIe NIC	Riser 1, 2, or 3	HHHL, SS
25 Gb NICs			
HX-P-I8D25GF	Cisco-Intel E810XXVDA2 2x25/10 GbE SFP28 PCIe NIC	Riser 1, 2, or 3	HHHL, SS
HX-P-I8Q25GF	Cisco-Intel E810XXVDA4L 4x25/10 GbE SFP28 PCIe NIC	Riser 1, 2, or 3	FHHL, SS
HX PCIe Accel Engine^{2,3}			
HX-PCIE-OFFLOAD-1	Application Acceleration Engine	Riser 1, 2, or 3	HHHL, SS

Notes:

1. HHHL = half-height, half-length; FHHL = full-height, half-length; S = single-slot; DS = double-slot

2. • Every node in an HX cluster must use HX-PCIE-OFFLOAD-1 card
 - Optional card offloads the compression functionality to HW acceleration card. HX-PCIE-OFFLOAD-1 uses a more computationally intensive compression algorithm. This results in lower storage space and frees up CPU cycle.
 - HXDP Enterprise licenses are required.
 - HX-PCIE-OFFLOAD-1 works with all HXDP features, including Stretched Cluster, SED drives and more
3. Please note that, HX-PCIE-OFFLOAD-1 is on Compliance Hold Review, for details contact: hx-order-compliance-hold@cisco.com



NOTE: Use of 10GE PCI card is not allowed with 6300 Series FI.

Caveats

- For 1-CPU systems:
 - Only PCIe slots 1, 2, and 3 on PCIe riser 1A are available for a 1-CPU system.
 - The PCIe slots on riser 2 are not supported on 1-CPU systems. The riser 2 slots are full-height PCIe slots 4, 5, and 6 (see [Figure 5 on page 12](#)). These are the slots in the middle when looking at the rear of the server. Slot 4 is the bottom slot.
 - The PCIe slots on riser 3 are not supported on 1-CPU systems. The riser 3 slots are full-height PCIe slots 7 and 8 (see [Figure 5 on page 12](#)). These are the slots on the right when looking at the rear of the server. Slot 7 is the bottom slot.
 - Only a single plug-in PCIe VIC card may be installed on a 1-CPU system, and it must be installed in slots 1, 2, or 3 of riser 1A.
 - You can order an mLOM VIC card to be installed in the mLOM slot internal to the chassis. You can also have a PCIe VIC in slot 2 and thus have a PCIe VIC and one mLOM VIC in operation at the same time. If you order a double-width GPU, it must be installed in slot 2; then a PCIe VIC can be installed in slot 1. See [Table 20 on page 55](#). See [Table 16 on page 49](#) for the selection of plug-in and mLOM VIC cards. See also [Table 1 on page 19](#) and [SPARE PARTS, page 93](#) for the PCIe slot physical descriptions.
- For 2-CPU systems:
 - The following PCIe slots are available:
 - Three on PCIe riser 1A (PCIe slots 1, 2, and 3),
 - Three on PCIe riser 2A (PCIe slots 4, 5, and 6),
 - Two on PCIe riser 3A (PCIe slots 7 and 8).
 - You can order an mLOM VIC card to be installed in the mLOM slot internal to the chassis. You can also have PCIe VICs in slot 2 and slot 5 and thus have two PCIe VICs and one mLOM VIC in operation at the same time. If you order a double width GPU, it must be installed in slots 2, 4 or 7; then two PCIe VIC can be installed in slot 1 and slot 4. See [Table 16 on page 49](#) for the selection of plug-in and mLOM VIC cards. See also [Table 1 on page 19](#) and [SPARE PARTS, page 93](#) for the PCIe slot physical descriptions.

- If GPUs are installed in slot 2 of riser 1A or slot 5 of riser 2A, the NCSI capability automatically switches over to slot 1 of riser 1A or slot 4 of Riser 2A. Therefore, Cisco PCIe VICs can be installed in slots 1 and 4 if GPUs are installed in slots 2 and 5. If you order multiple GPUs, they must be installed as shown in [Table 20 on page 55](#).



NOTE: UCSM managed servers are discoverable only if a PCIe VIC is installed or a VIC is installed in the MLOM slot.

- The server supports up to two PCIe Cisco VICs plus an MLOM VIC

However, single wire management is supported on only one VIC at a time. If multiple VICs are installed on a server, only one slot has NCSI enabled at a time and for single wire management, priority goes to the MLOM slot, then slot 2, then slot 5 for NCSI management traffic. When multiple cards are installed, connect the single wire management cables in the priority order mentioned above.

- To help ensure that your operating system is compatible with the card you have selected, or to see additional cards that have been qualified to work with the HX240C M6 All NVMe/All Flash/Hybrid server, but are not sold on the Cisco price list, check the Hardware Compatibility List at this URL:
http://www.cisco.com/en/US/products/ps10477/prod_technical_reference_list.html

STEP 10 ORDER OPTIONAL PCIe OPTION CARD ACCESSORIES

- For list of supported optics and cables for VIC 1455, VIC 1495, VIC 1467 and 1477, refer to the VIC 1400 series data sheets at the following links:
 - <https://www.cisco.com/c/en/us/products/servers-unified-computing/HX-b-series-blade-servers/datasheet-listing.html>

Select

- NIC Interoperability with Cisco Cables/Optics (*Table 17 & Table 18 on page 53*).
- NIC Interoperability with Intel Cables/Optics (*Table 19 on page 54*).

Table 17 10G NIC Interoperability with Cisco Cables/Optics

Cisco Product ID (PID)	HX- PCIE-ID10GF	HX- PCIE-IQ10GF	HX-P-ID10GC
Cisco Direct Attach Cables (DAC)			
SFP-H10GB-CU1M	✓	✓	
SFP-H10GB-CU3M	✓	✓	
SFP-H10GB-CU5M	✓	✓	
SFP-H10GB-ACU7M	✓	✓	
SFP-H10GB-ACU10M	✓	✓	
SFP-10G-AOC1M	✓	✓	
SFP-10G-AOC2M	✓	✓	
SFP-10G-AOC3M	✓	✓	
SFP-10G-AOC5M	✓	✓	
SFP-10G-AOC7M	✓	✓	
SFP-10G-AOC10M	✓	✓	
UTP/RJ45			✓
Cisco Optical Transceivers			
SFP-10G-SR	✓	✓	
SFP-10G-SR-S	✓	✓	
SFP-10G-LR	✓	✓	
SFP-10G-LR-S	✓	✓	
GLC-SX-MMD	✓	✓	

Table 18 25G NIC Interoperability with Cisco Cables/Optics

Cisco Product ID (PID)	HX-P-I8Q25GF	HX-P-I8D25GF
Cisco Direct Attach Cables (DAC)		
SFP-H10GB-CU1M	✓	✓
SFP-H10GB-CU3M	✓	✓
SFP-H10GB-CU4M		
SFP-H10GB-CU5M	✓	✓
SFP-H10GB-ACU7M		
SFP-H10GB-ACU10M		
SFP-10G-AOC7M	✓	✓
SFP-10G-AOC10M		
SFP-H25G-AOC10M	✓	✓
SFP-25G-AOC5M		
SFP-25G-AOC7M		
QSFP-4SFP25G-CU2M	✓	✓
SFP-H25G-CU1M	✓	✓
SFP-H25G-CU2M	✓	✓
SFP-H25G-CU2.5M		
SFP-H25G-CU3M	✓	✓
SFP-H25G-CU4M		
SFP-H25G-CU5M	✓	✓
Cisco Optical Transceivers		
SFP-10G-SR	✓	✓
SFP-10G-SR-S	✓	✓
SFP-10G-LR	✓	✓
SFP-25G-SR-S	✓	✓
SFP-10/25G-LR-S	✓	✓
SFP-10/25G-CSR-S	✓	✓

Table 19 NIC Interoperability with Intel Cables/Optics

Intel Product ID (PID)	HX-PCIE-ID10GF	HX-PCIE-IQ10GF
Intel Direct Attach Cables (DACs)		
XDACBL1M	✓	✓
XDACBL3M	✓	✓
XDACBL5M	✓	✓
Intel Optical Transceivers		
E10GSFPSR	✓	✓
E10GSFPLR	✓	✓

The information in the preceding tables was compiled from testing conducted by Cisco Transceiver Module Group (TMG) and vendors. The latest compatibility with optical modules and DACs can be found at <https://tmgmatrix.cisco.com/>.

Refer to the these links for additional connectivity options:

Intel:	Marvell/Qlogic:	Mellanox:
Product Guide	41000 series Interoperability Matrix	Firmware Release Notes
Speed White Paper	45000 series Interoperability Matrix	

STEP 11 ORDER GPU CARDS (OPTIONAL)



NOTE: When a GPU is ordered, the server comes with low-profile heatsinks PID (HX-HSLP-M6=) and need to select special air duct PID (HX-ADGPU-245M6=) for double-wide GPUs.

Select GPU Options

The available GPU PCIe options and their riser slot compatibilities are listed in [Table 20](#)

Table 20 Available PCIe GPU Cards¹

GPU Product ID (PID)	PID Description	Card Size	Max GPU per Node	Riser Slot Compatibility					
				Riser 1A (Gen 4)	Riser 1B ²	Riser 2 (Gen 4)	Riser 3A ³ Gen 4)	Riser 3B ⁴	Riser 3C ^{5,6}
HX-GPU-A10	TESLA A10, PASSIVE, 150W, 24GB	Single-wide	5	slot 2&3	N/A	slot 5&6	N/A	N/A	slot 7
HX-GPU-A30	TESLA A30, PASSIVE, 180W, 24GB	Double-wide	3	slot 2	N/A	slot 5	N/A	N/A	slot 7
HX-GPU-A40	TESLA A40 RTX, PASSIVE, 300W, 48GB	Double-wide	3	slot 2	N/A	slot 5	N/A	N/A	slot 7
HX-GPU-A100-80	TESLA A100, PASSIVE, 300W, 80GB	Double-wide	3	slot 2	N/A	slot 5	N/A	N/A	slot 7
HX-GPU-A16	NVIDIA A16 PCIE 250W 4X16GB	Double-wide	3	slot 2	N/A	slot 5	N/A	N/A	slot 7

Notes:

1. Refer to [installation guide](#) for the GPU related information
2. Riser 1B does not accept GPUs
3. Riser 3A does not accept GPUs
4. Riser 3B does not accept GPUs
5. The server supports one full-height, full-length, double-wide GPU (PCIe slot 7 only) in Riser 3C.
6. All NVMe server does not support riser 3C

**NOTE:**

- All NVMe server does not support riser 3
 - All GPU cards must be procured from Cisco as there is a unique SBIOS ID required by CIMC and UCSM.
 - If you are adding GPUs later, please refer to [SPARE PARTS, page 93](#) section of the below spec sheet to find the accessories/cables needed along with the GPU spare.
 - Please refer to [installation guide](#) for the GPU related information.
 - GPUs cannot be mixed.
-

STEP 12 ORDER POWER SUPPLY

Power supplies share a common electrical and physical design that allows for hot-plug and tool-less installation into M6 HX-Series servers. Each power supply is certified for high-efficiency operation and offer multiple power output options. This allows users to “right-size” based on server configuration, which improves power efficiency, lower overall energy costs and avoid stranded capacity in the data center. Use the power calculator at the following link to determine the needed power based on the options chosen (CPUs, drives, memory, and so on):

<http://ucspowercalc.cisco.com>



WARNING:

- Starting 1st January 2024, only Titanium rated PSUs are allowed to be shipped to European Union (EU), European Economic Area (EEA), United Kingdom (UK), Switzerland and other countries that adopted Lot 9 Regulation.
- DC PSUs are not impacted by Lot 9 Regulation and are EU/UK Lot 9 compliant

Table 21 Power Supply

Product ID (PID)	PID Description
PSU (Input High Line 210VAC)	
HX-PSU1-1050W	1050W AC PSU Platinum (Not EU/UK Lot 9 Compliant)
HX-PSUV2-1050DC	1050W -48V DC Power Supply for Rack Server
HX-PSU1-1600W	1600W AC PSU Platinum (Not EU/UK Lot 9 Compliant)
HX-PSU1-2300W ¹	2300W AC Power Supply for Rack Servers Titanium
PSU (Input Low Line 110VAC)	
HX-PSU1-1050W	1050W AC PSU Platinum (Not EU/UK Lot 9 Compliant)
HX-PSUV2-1050DC	1050W -48V DC Power Supply for Rack Server
HX-PSU1-2300W	2300W AC Power Supply for Rack Servers Titanium
HX-PSU1-1050ELV	1050W AC PSU Enhanced Low Line (Not EU/UK Lot 9 Compliant)

Notes:

1. The 2300 W power supply uses a different power connector than the rest of the power supplies, so you must use different power cables to connect it. See [Table 22 on page 58](#) and [Table 23 on page 61](#).



NOTE: In a server with two power supplies, both power supplies must be identical.

STEP 13 SELECT INPUT POWER CORD(S)

Using [Table 22](#) and [Table 23](#), select the appropriate AC power cords. You can select a minimum of no power cords and a maximum of two. If you select the option R2XX-DMYPWRCORD, no power cord is shipped with the server.



NOTE: [Table 22](#) lists the power cords for servers that use power supplies less than 2300 W. [Table 23](#) lists the power cords for servers that use 2300 W power supplies. Note that the power cords for 2300 W power supplies use a C19 connector so they only fit the 2300 W power supply connector.

Table 22 Available Power Cords (for server PSUs less than 2300 W)

Product ID (PID)	PID Description	Images
NO-POWER-CORD	ECO friendly green option, no power cable will be shipped	
R2XX-DMYPWRCORD	No power cord (dummy PID to allow for a no power cord option)	Not applicable
CAB-48DC-40A-8AWG	C-Series -48VDC PSU Power Cord, 3.5M, 3 Wire, 8AWG, 40A	<p>Figure 1-3 CAB-48DC-40A-8AWG, DC Power Cord (3.5 m)</p>
CAB-N5K6A-NA	Power Cord, 200/240V 6A, North America	
CAB-AC-L620-C13	AC Power Cord, NEMA L6-20 - C13, 2M/6.5ft	
CAB-C13-CBN	CABASY,WIRE,JUMPER CORD, 27" L, C13/C14, 10A/250V	
CAB-C13-C14-2M	CABASY,WIRE,JUMPER CORD, PWR, 2 Meter, C13/C14,10A/250V	

Table 22 Available Power Cords (for server PSUs less than 2300 W)

Product ID (PID)	PID Description	Images
CAB-C13-C14-AC	CORD,PWR,JMP,IEC60320/C14,IEC60320/C13, 3.0M	
CAB-250V-10A-AR	Power Cord, 250V, 10A, Argentina	
CAB-9K10A-AU	Power Cord, 250VAC 10A 3112 Plug, Australia	
CAB-250V-10A-CN	AC Power Cord - 250V, 10A - PRC	
CAB-9K10A-EU	Power Cord, 250VAC 10A CEE 7/7 Plug, EU	
CAB-250V-10A-ID	Power Cord, 250V, 10A, India	
CAB-C13-C14-3M-IN	Power Cord Jumper, C13-C14 Connectors, 3 Meter Length, India	Image not available
CAB-C13-C14-IN	Power Cord Jumper,C13-C14 Connectors,1.4 Meter Length, India	Image not available
CAB-250V-10A-IS	Power Cord, SFS, 250V, 10A, Israel	

Table 22 Available Power Cords (for server PSUs less than 2300 W)

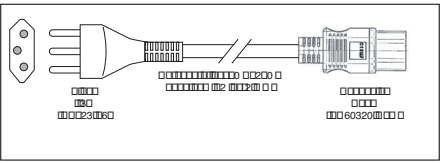
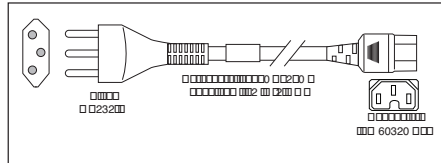
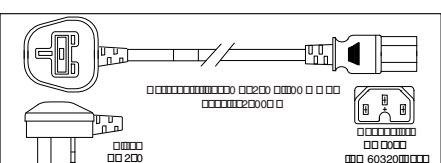
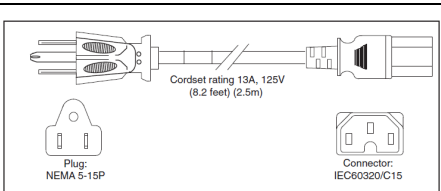
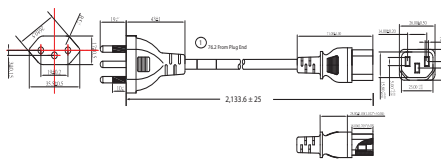
Product ID (PID)	PID Description	Images
CAB-9K10A-IT	Power Cord, 250VAC 10A CEI 23-16/VII Plug, Italy	
CAB-9K10A-SW	Power Cord, 250VAC 10A MP232 Plug, Switzerland	
CAB-9K10A-UK	Power Cord, 250VAC 10A BS1363 Plug (13 A fuse), UK	
CAB-9K12A-NA ¹	Power Cord, 125VAC 13A NEMA 5-15 Plug, North America	
CAB-250V-10A-BR	Power Cord - 250V, 10A - Brazil	
CAB-C13-C14-2M-JP	Power Cord C13-C14, 2M/6.5ft Japan PSE mark	Image not available
CAB-9K10A-KOR ¹	Power Cord, 125VAC 13A KSC8305 Plug, Korea	Image not available
CAB-ACTW	AC Power Cord (Taiwan), C13, EL 302, 2.3M	Image not available
CAB-JPN-3PIN	Japan, 90-125VAC 12A NEMA 5-15 Plug, 2.4m	Image not available
CAB-48DC-40A-INT	C-Series -48VDC PSU PWR Cord, 3.5M, 3 Wire, 8AWG, 40A (INT)	Image not available
CAB-48DC-40A-AS	C-Series -48VDC PSU PWR Cord, 3.5M, 3Wire, 8AWG, 40A (AS/NZ)	Image not available

Notes:

1. This power cord is rated to 125V and only supported for PSU rated at 1050W or less

Table 23 Available Power Cords (for servers with 2300 W PSUs)

Product ID (PID)	PID Description	Images
CAB-C19-CBN	Cabinet Jumper Power Cord, 250 VAC 16A, C20-C19 Connectors	Not applicable
CAB-S132-C19-ISRL	S132 to IEC-C19 14ft Israeli	Image not available
CAB-IR2073-C19-AR	IRSM 2073 to IEC-C19 14ft Argen	Image not available
CAB-BS1363-C19-UK	BS-1363 to IEC-C19 14ft UK	Image not available
CAB-SABS-C19-IND	SABS 164-1 to IEC-C19 India	Image not available
CAB-C2316-C19-IT	CEI 23-16 to IEC-C19 14ft Italy	Image not available
CAB-L520P-C19-US	NEMA L5-20 to IEC-C19 6ft US	Image not available
CAB-US515P-C19-US	NEMA 5-15 to IEC-C19 13ft US	Image not available
CAB-US520-C19-US	NEMA 5-20 to IEC-C19 14ft US	Image not available
CAB-US620P-C19-US	NEMA 6-20 to IEC-C19 13ft US	Image not available

STEP 14 ORDER TOOL-LESS RAIL KIT AND OPTIONAL REVERSIBLE CABLE MANAGEMENT ARM

Select a Tool-less Rail Kit

Select a tool-less rail kit (or no rail kit) from [Table 24](#).

Table 24 Tool-less Rail Kit Options

Product ID (PID)	PID Description
HX-RAIL-M6	Ball Bearing Rail Kit for C220 & C240 M6 rack servers
HX-RAIL-NONE	No rail kit option



NOTE: Cisco recommends a minimum quantity of 1 Rail Kit.

Select an Optional Reversible Cable Management Arm

The reversible cable management arm mounts on either the right or left slide rails at the rear of the server and is used for cable management. Use [Table 25](#) to order a cable management arm.

Table 25 Cable Management Arm

Product ID (PID)	PID Description
HX-CMA-C240M6	Reversible CMA for C240 M6 ball bearing rail kit

For more information about the tool-less rail kit and cable management arm, see the Cisco server Installation and Service Guide at this URL:

https://www.cisco.com/content/en/us/td/docs/unified_computing/ucs/c/hw/c240m6/install/c240m6.html



NOTE: If you plan to rackmount your HyperFlex HX240C M6 All NVMe/All Flash/Hybrid Server Nodes, you must order a tool-less rail kit. The same rail kits and CMAs are used for M5 and M6 servers.

STEP 15 ORDER SECURITY DEVICES (OPTIONAL)

A Trusted Platform Module (TPM) is a computer chip (microcontroller) that can securely store artifacts used to authenticate the platform (server). These artifacts can include passwords, certificates, or encryption keys. A TPM can also be used to store platform measurements that help ensure that the platform remains trustworthy. Authentication (ensuring that the platform can prove that it is what it claims to be) and attestation (a process helping to prove that a platform is trustworthy and has not been breached) are necessary steps to ensure safer computing in all environments.

A chassis intrusion switch gives a notification of any unauthorized mechanical access into the server.

The security device ordering information is listed in [Table 26](#).

Table 26 Security Devices

Product ID (PID)	PID Description
HX-TPM-002C	TPM 2.0, TCG, FIPS140-2, CC EAL4+ Certified, for M6 servers
HX-INT-SW02	C220 and C240 M6 Chassis Intrusion Switch
UCSX-TPM-OPT-OUT	OPT OUT, TPM 2.0, TCG, FIPS140-2, CC EAL4+ Certified ¹

Notes:

1. Please note that Microsoft certification requires a TPM 2.0 for bare-metal or guest VM deployments. Opt-out of the TPM 2.0 voids the Microsoft certification



NOTE:

- The TPM module used in this system conforms to TPM 2.0, as defined by the Trusted Computing Group (TCG). It is also SPI-based.
- TPM installation is supported after-factory. However, a TPM installs with a one-way screw and cannot be replaced, upgraded, or moved to another server. If a server with a TPM is returned, the replacement server must be ordered with a new TPM.

STEP 16 SELECT LOCKING SECURITY BEZEL (OPTIONAL)

An optional locking bezel can be mounted to the front of the chassis to prevent unauthorized access to the drives.

Select the locking bezel from [Table 27](#).

Table 27 Locking Bezel Option

Product ID (PID)	Description
HXAF240C-BZL-M5SN	HXAF240C M5 All NVMe Security Bezel
HXAF240C-BZL-M5SX	HXAF240C M5 Security Bezel
HX240C-BZL-M5S	HX240C M5 Security Bezel

STEP 17 SELECT HOST OPERATING SYSTEM

Select Microsoft Windows operating system as desired from [Table 28](#)



NOTE:

- **VMware ESXi Hypervisor** - We no longer ship VMWare ESXi from the factory. Refer to this link for the further details.
https://www.cisco.com/c/en/us/td/docs/hyperconverged_systems/HyperFlex_HX_DataPlatformSoftware/BroadcomAgreementNotice/b-broadcom-terminated-vmware-embedded-agreement.html
- **Microsoft operating system** - Optional guest OS licenses that may be purchased to run on top of the hypervisor.

Table 28 Host Operation System

Product ID (PID)	PID Description
Operating system	
Microsoft Options	
HX-MSWS-22-ST16C	Windows Server 2022 Standard (16 Cores/2 VMs)
HX-MSWS-22-DC16C	Windows Server 2022 Data Center (16 Cores/Unlimited VMs)

STEP 18 SELECT HYPERFLEX DATA PLATFORM (HXDP) SOFTWARE

HyperFlex Data Platform Edition & Subscription Period options are available as follows. Select as desired from [Table 29](#)

Table 29 HX Data Platform Software

Product ID (PID)	PID Description
Cisco HyperFlex Data Platform Software	
HXDP-DC-AD	HyperFlex Data Platform Data center Advantage (1 to 5) Yr
HXDP-DC-PR	HyperFlex Data Platform Data center Premier (1 to 5) Yr
Cisco HyperFlex Data Platform Software - SLR	
HXDP-DC-AD-SLR	HyperFlex Data Platform Data center Advantage SLR (1 to 5) Yr
HXDP-DC-PR-SLR	HyperFlex Data Platform Data center Premier SLR (1 to 5) Yr
Cisco HyperFlex Data Platform Software Support	
SVS-DCM-SUPT-BAS	Basic Support for DCM
SVS-SSTCS-DCMGMT	Solution Support for DC Mgmt
SVS-L1DCS-HXDP	CXL1 for HXDP
SVS-L2DCS-HXDP	CXL2 for HXDP

STEP 19 CISCO INTERSIGHT

Cisco Intersight™ is a Software-as-a-Service (SaaS) hybrid cloud operations platform which delivers intelligent automation, observability, and optimization to customers for traditional and cloud-native applications and infrastructure. Select as desired from [Table 30](#).

Table 30 Cisco Intersight

Product ID (PID)	PID Description
Cisco Intersight - SaaS	
DC-MGT-SAAS-EST-C	Cisco Intersight SaaS - Essentials (1 to 5) Yr
DC-MGT-SAAS-AD-C	Cisco Intersight SaaS - Advantage (new) (1 to 5) Yr
DC-MGT-SAAS-PR-C	Cisco Intersight SaaS - Premier (1 to 5) Yr
Cisco Intersight - Connected Virtual Appliance	
DC-MGT-ONPREM-EST	Cisco Intersight Connected Virtual Appliance - Essentials (1 to 5) Yr
DC-MGT-VAPP-AD	Cisco Intersight Connected Virtual Appliance - Advantage (1 to 5) Yr
DC-MGT-VAPP-PR	Cisco Intersight Connected Virtual Appliance - Premier (1 to 5) Yr
Cisco Intersight - Private Virtual Appliance	
DC-MGT-PVAPP-EST	Cisco Intersight Private Virtual Appliance - Essentials (1 to 5) Yr
DC-MGT-PVAPP-AD	Cisco Intersight Private Virtual Appliance - Advantage (1 to 5) Yr
DC-MGT-PVAPP-PR	Cisco Intersight Private Virtual Appliance - Premier (1 to 5) Yr
Cisco Intersight Support	
SVS-DCM-SUPT-BAS	Basic Support for DCM
SVS-SSTCS-DCMGMT	Solution Support for DC Mgmt
SVS-L1DCS-INTER	CXL1 for INTERSIGHT
SVS-L2DCS-INTER	CXL2 for INTERSIGHT

STEP 20 SELECT INSTALLATION SERVICE

Customers can purchase Cisco Advanced Services (AS). Select as desired from [Table 31](#)

Table 31 Installation services

Product ID (PID)	PID Description
Cisco Advanced Services	
ASF-ULT2-HPF-QSS	Quick Start Services - 1 Week
ASF-ULT2-HPF-ADS	Accelerated Deployment Services - 2 Weeks
AS-DCN-CNSLT	Advanced Services Consulting

STEP 21 SELECT SERVICE and SUPPORT LEVEL

A variety of service options are available, as described in this section.

HyperFlex Warranty, No Contract

If you have noncritical implementations and choose to have no service contract, the following coverage is supplied:

- Three-year parts coverage.
- Next business day (NBD) onsite parts replacement eight hours a day, five days a week.
- 90-day software warranty on media.
- Ongoing downloads of BIOS, drivers, and firmware updates.
- UCSM updates for systems with Unified Computing System Manager. These updates include minor enhancements and bug fixes that are designed to maintain the compliance of UCSM with published specifications, release notes, and industry standards.

Smart Net Total Care (SNTC)

For support of the entire HyperFlex System, Cisco offers the Cisco Smart Net Total Care Service. This service provides expert software and hardware support to help sustain performance and high availability of the unified computing environment. Access to Cisco Technical Assistance Center (TAC) is provided around the clock, from anywhere in the world.

For systems that include Unified Computing System Manager, the support service includes downloads of UCSM upgrades. The Cisco Smart Net Total Care Service includes flexible hardware replacement options, including replacement in as little as two hours. There is also access to Cisco's extensive online technical resources to help maintain optimal efficiency and uptime of the unified computing environment. For more information please refer to the following url: <http://www.cisco.com/c/en/us/services/technical/smart-net-total-care.html?stickynav=1>

You can choose a desired service listed in [Table 32](#).

Table 32 SNTC Service (PID HXAF240C-M6SN)

Service SKU	Service Level GSP	On Site?	Description
CON-PREM-HXAF240C	C2P	Yes	SNTC 24X7X20S
CON-UCSD8-HXAF240C	UCSD8	Yes	UC SUPP DR
CON-C2PL-HXAF240C	C2PL	Yes	LL 24X7X20S**
CON-OSP-HXAF240C	C4P	Yes	SNTC 24X7X40S
CON-UCSD7-HXAF240C	UCSD7	Yes	UCS DR 24X7X40S*
CON-C4PL-HXAF240C	C4PL	Yes	LL 24X7X40S**
CON-USD7L-HXAF240C	USD7L	Yes	LLUCS HW DR 24X7X40S***
CON-OSE-HXAF240C	C4S	Yes	SNTC 8X5X40S
CON-UCSD6-HXAF240C	UCSD6	Yes	UC SUPP DR 8X5X40S*

Table 32 SNTC Service (PID HXAF240C-M6SN)

CON-SNCO-HXAF240C	SNCO	Yes	SNTC 8x7xNCDOS****
CON-OS-HXAF240C	CS	Yes	SNTC 8X5XNBDOS
CON-UCSD5-HXAF240C	UCSD5	Yes	UCS DR 8X5XNBDOS*
CON-S2P-HXAF240C	S2P	No	SNTC 24X7X2
CON-S2PL-HXAF240C	S2PL	No	LL 24X7X2**
CON-SNTP-HXAF240C	SNTP	No	SNTC 24X7X4
CON-SNTPL-HXAF240C	SNTPL	No	LL 24X7X4**
CON-SNTE-HXAF240C	SNTE	No	SNTC 8X5X4
CON-SNC-HXAF240C	SNC	No	SNTC 8x7xNCD
CON-SNT-HXAF240C	SNT	No	SNTC 8X5XNBD
CON-SW-HXAF240C	SW	No	SNTC NO RMA
Note: For PID HXAF240C-M6SX, select Service SKU with HXAF24CX suffix (Example: CON-OSP-HXAF24CX)			
For PID HX240C-M6SX, select Service SKU with HX240CMX suffix (Example: CON-OSP-HX240CMX)			
*Includes Drive Retention (see below for full description)			
**Includes Local Language Support (see below for full description) - Only available in China and Japan			
***Includes Local Language Support and Drive Retention - Only available in China and Japan			

Smart Net Total Care Onsite Troubleshooting Service

An enhanced offer over traditional Smart Net Total Care which provides onsite troubleshooting expertise to aid in the diagnostics and isolation of hardware issue within our customers' Cisco HyperFlex System environment. It is delivered by a Cisco Certified field engineer (FE) in collaboration with remote TAC engineer and Virtual Internetworking Support Engineer (VISE).

You can choose a desired service listed in [Table 33](#).

Table 33 SNTC Onsite Troubleshooting Service (PID HXAF240C-M6SN)

Service SKU	Service Level GSP	On Site?	Description
CON-OSPT-HXAF240C	OSPT	Yes	24X7X4OS Trblshtg
CON-OSPTD-HXAF240C	OSPTD	Yes	24X7X4OS TrblshtgDR*
CON-OSPTL-HXAF240C	OSPTL	Yes	24X7X4OS TrblshtgLL**
CON-OPTLD-HXAF240C	OPTLD	Yes	24X7X4OS TrblshtgLLD***
Note: For PID HXAF240C-M6SX, select Service SKU with HXAF24CX suffix (Example: CON-OSPT-HXAF24CX)			
For PID HX240C-M6SX, select Service SKU with HX240CMX suffix (Example: CON-OSPT-HX240CMX)			

Table 33 SNTC Onsite Troubleshooting Service (PID HXAF240C-M6SN)

*Includes Drive Retention (see below for full description)
**Includes Local Language Support (see below for full description) - Only available in China and Japan
***Includes Local Language Support and Drive Retention - Only available in China and Japan

Solution Support (SSPT)

Solution Support includes both Cisco product support and solution-level support, resolving complex issues in multivendor environments, on average, 43% more quickly than product support alone. Solution Support is a critical element in data center administration, to help rapidly resolve any issue encountered, while maintaining performance, reliability, and return on investment.

This service centralizes support across your multivendor Cisco environment for both our products and solution partner products you’ve deployed in your ecosystem. Whether there is an issue with a Cisco or solution partner product, just call us. Our experts are the primary point of contact and own the case from first call to resolution. For more information please refer to the following url:

<http://www.cisco.com/c/en/us/services/technical/solution-support.html?stickynav=1>

You can choose a desired service listed in *Table 34*.

Table 34 Solution Support Service (PID HXAF240C-M6SN)

Service SKU	Service Level GSP	On Site?	Description
CON-SSC2P-HXAF240C	SSC2P	Yes	SOLN SUPP 24X7X2OS
CON-SSC4P-HXAF240C	SSC4P	Yes	SOLN SUPP 24X7X4OS
CON-SSC4S-HXAF240C	SSC4S	Yes	SOLN SUPP 8X5X4OS
CON-SSCS-HXAF240C	SSCS	Yes	SOLN SUPP 8X5XNBDOS
CON-SSDR7-HXAF240C	SSDR7	Yes	SSPT DR 24X7X4OS*
CON-SSDR5-HXAF240C	SSDR5	Yes	SSPT DR 8X5XNBDOS*
CON-SSS2P-HXAF240C	SSS2P	No	SOLN SUPP 24X7X2
CON-SSSNP-HXAF240C	SSSNP	No	SOLN SUPP 24X7X4
CON-SSSNE-HXAF240C	SSSNE	No	SOLN SUPP 8X5X4
CON-SSSNC-HXAF240C	SSSNC	No	SOLN SUPP NCD
CON-SSSNT-HXAF240C	SSSNT	No	SOLN SUPP 8X5XNBD
Note: For PID HXAF240C-M6SX, select Service SKU with HXAF24CX suffix (Example: CON-SSC4P-HXAF24CX)			
For PID HX240C-M6SX, select Service SKU with HX240CMX suffix (Example: CON-SSC4P-HX240CMX)			
*Includes Drive Retention (see below for full description)			

Solution Support for Service Providers

You can choose a desired service listed in [Table 35](#).

Table 35 Solution Support for Service Providers Service (PID HXAF240C-M6SN)

Service SKU	Service Level GSP	On Site?	Description
SP-SSC2P-HXAF240C	SPSSC2P	Yes	SP SOLN SUPP
SP-SSC4P-HXAF240C	SPSSC4P	Yes	SP SOLN SUPP
SP-SSC4S-HXAF240C	SPSSC4S	Yes	SP SOLN SUPP
SP-SSCS-HXAF240C	SPSSCS	Yes	SP SOLN SUPP
SP-SSS2P-HXAF240C	SPSSS2P	Yes	SP SOLN SUPP 24X7X2
SP-SSS4P-HXAF240C	SPSSS4P	Yes	SP SOLN SUPP 24X7X4
SP-SSSNE-HXAF240C	SPSSSNE	No	SP SOLN SUPP 8X5X4
SP-SSSNT-HXAF240C	SPSSSNT	No	SP SOLN SUPP
SP-SSSPB-HXAF240C	SPSSSPB	No	SP SOLN SUPP NO HW
Note: For PID HXAF240C-M6SX, select Service SKU with HXAF24CX suffix (Example: SP-SSC4P-HXAF24CX)			
For PID HX240C-M6SX, select Service SKU with HX240CMX suffix (Example: SP-SSC4P-HX240CMX)			

Smart Net Total Care Hardware Only Service

For faster parts replacement than is provided with the standard Cisco HyperFlex warranty, Cisco offers the Cisco Smart Net Total Care Hardware Only Service. You can choose from two levels of advanced onsite parts replacement coverage in as little as four hours. Smart Net Total Care Hardware Only Service provides remote access any time to Cisco support professionals who can determine if a return materials authorization (RMA) is required.

You can choose a desired service listed in [Table 36](#).

Table 36 SNTC Hardware Only Service (PID HXAF240C-M6SN)

Service SKU	Service Level GSP	On Site?	Description
CON-UCW7-HXAF240C	UCW7	Yes	UCS HW 24X7X40S
CON-UCWD7-HXAF240C	UCWD7	Yes	UCS HW+DR 24X7X40S*
CON-UCW7L-HXAF240C	UCW7L	Yes	LL UCS 24X7X40S**
CON-UWD7L-HXAF240C	UWD7L	Yes	LL UCS DR 24X7X40S***
CON-UCW5-HXAF240C	UCW5	Yes	UCS HW 8X5XNBDOS
CON-UCWD5-HXAF240C	UCWD5	Yes	UCS HW+DR 8X5XNBDOS*

Table 36 SNTC Hardware Only Service (PID HXAF240C-M6SN)

Note: For PID HXAF240C-M6SX, select Service SKU with HXAF24CX suffix (Example: CON-UCW7-HXAF24CX)
For PID HX240C-M6SX, select Service SKU with HX240CMX suffix (Example: CON-UCW7-HX240CMX)
*Includes Drive Retention (see below for full description)
**Includes Local Language Support (see below for full description) - Only available in China and Japan
***Includes Local Language Support and Drive Retention - Only available in China and Japan

Partner Support Service

Cisco Partner Support Service (PSS) is a Cisco Collaborative Services service offering that is designed for partners to deliver their own branded support and managed services to enterprise customers. Cisco PSS provides partners with access to Cisco's support infrastructure and assets to help them:

- Expand their service portfolios to support the most complex network environments
- Lower delivery costs
- Deliver services that increase customer loyalty

PSS options enable eligible Cisco partners to develop and consistently deliver high-value technical support that capitalizes on Cisco intellectual assets. This helps partners to realize higher margins and expand their practice.

PSS is available to all Cisco PSS partners.

The two Partner Support Options include:

- Partner Support Service for HyperFlex
- Partner Support Service for HyperFlex Hardware Only

PSS provides hardware and software support, including triage support for third party software, backed by Cisco technical resources and level three support.

You can choose a desired service listed in [Table 37](#).

Table 37 PSS Service (PID HXAF240C-M6SN)

Service SKU	Service Level GSP	On Site?	Description
CON-PSJ8-HXAF240C	PSJ8	Yes	UCS PSS 24X7X2 OS
CON-PSJ7-HXAF240C	PSJ7	Yes	UCS PSS 24X7X4 OS
CON-PSJD7-HXAF240C	PSJD7	Yes	UCS PSS 24X7X4 DR*
CON-PSJ6-HXAF240C	PSJ6	Yes	UCS PSS 8X5X4 OS
CON-PSJD6-HXAF240C	PSJD6	Yes	UCS PSS 8X5X4 DR*
CON-PSJ4-HXAF240C	PSJ4	No	UCS SUPP PSS 24X7X2

Table 37 PSS Service (PID HXAF240C-M6SN)

CON-PSJ3-HXAF240C	PSJ3	No	UCS SUPP PSS 24X7X4
CON-PSJ2-HXAF240C	PSJ2	No	UCS SUPP PSS 8X5X4
CON-PSJ1-HXAF240C	PSJ1	No	UCS SUPP PSS 8X5XNBD
Note: For PID HXAF240C-M6SX, select Service SKU with HXAF24CX suffix (Example: CON-PSJ7-HXAF24CX)			
For PID HX240C-M6SX, select Service SKU with HX240CMX suffix (Example: CON-PSJ7-HX240CMX)			
*Includes Drive Retention (see below for full description)			

PSS Hardware Only

PSS Hardware Only provides customers with replacement parts in as little as two hours and provides remote access any time to Partner Support professionals who can determine if a return materials authorization (RMA) is required. You can choose a desired service listed in [Table 38](#).

Table 38 PSS Hardware Only Service (PID HXAF240C-M6SN)

Service SKU	Service Level GSP	On Site?	Description
CON-PSW7-HXAF240C	PSW7	Yes	UCS W PSS 24X7X4 OS
CON-PSWD7-HXAF240C	PSWD7	Yes	UCS W PSS 24X7X4 DR*
CON-PSW6-HXAF240C	PSW6	Yes	UCS W PSS 8X5X4 OS
CON-PSWD6-HXAF240C	PSWD6	Yes	UCS W PSS 8X5X4 DR*
CON-PSW4-HXAF240C	PSW4	No	UCS W PL PSS 24X7X2
CON-PSW3-HXAF240C	PSW3	No	UCS W PL PSS 24X7X4
CON-PSW2-HXAF240C	PSW2	No	UCS W PL PSS 8X5X4
Note: For PID HXAF240C-M6SX, select Service SKU with HXAF24CX suffix (Example: CON-PSW7-HXAF24CX)			
For PID HX240C-M6SX, select Service SKU with HX240CMX suffix (Example: CON-PSW7-HX240CMX)			
*Includes Drive Retention (see below for full description)			

Distributor Support Service (DSS)

You can choose a desired service listed in [Table 39](#).

Table 39 DSS Service (PID HXAF240C-M6SN)

Service SKU	Service Level GSP	On Site?	Description
CON-DSCO-HXAF240C	DSCO	Yes	DSS CORE 24X7X2OS
CON-DSO-HXAF240C	DSO	Yes	DSS CORE 24X7X4
CON-DSNO-HXAF240C	DSNO	Yes	DSS CORE 8X5XNBDOS
CON-DSCC-HXAF240C	DSCC	No	DSS CORE 24X7X2
CON-DCP-HXAF240C	DCP	No	DSS CORE 24X7X4
CON-DSE-HXAF240C	DSE	No	DSS CORE 8X5X4
CON-DSN-HXAF240C	DSN	No	DSS CORE 8X5XNBD
Note: For PID HXAF240C-M6SX, select Service SKU with HXAF24CX suffix (Example: CON-DSO-HXAF24CX)			
For PID HX240C-M6SX, select Service SKU with HX240CMX suffix (Example: CON-DSO-HX240CMX)			

Combined Support Service

Combined Services makes it easier to purchase and manage required services under one contract. SNTC services help increase the availability of your vital data center infrastructure and realize the most value from your unified computing investment. The more benefits you realize from the Cisco HyperFlex System, the more important the technology becomes to your business. These services allow you to:

- Optimize the uptime, performance, and efficiency of your HyperFlex system
- Protect your vital business applications by rapidly identifying and addressing issues
- Strengthen in-house expertise through knowledge transfer and mentoring
- Improve operational efficiency by allowing HyperFlex experts to augment your internal staff resources
- Enhance business agility by diagnosing potential issues before they affect your operations

You can choose a desired service listed in [Table 40](#).

Table 40 Combined Support Service (PID HXAF240C-M6SN)

Service SKU	Service Level GSP	On Site?	Description
-------------	-------------------	----------	-------------

Table 40 Combined Support Service (PID HXAF240C-M6SN)

CON-NCF2P-HXAF240C	NCF2P	Yes	CMB SVC 24X7X20S
CON-NCF4P-HXAF240C	NCF4P	Yes	CMB SVC 24X7X40S
CON-NCF4S-HXAF240C	NCF4S	Yes	CMB SVC 8X5X40S
CON-NCFCS-HXAF240C	NCFCS	Yes	CMB SVC 8X5XNBDOS
CON-NCF2-HXAF240C	NCF2	No	CMB SVC 24X7X2
CON-NCFP-HXAF240C	NCFP	No	CMB SVC 24X7X4
CON-NCFE-HXAF240C	NCFE	No	CMB SVC 8X5X4
CON-NCFT-HXAF240C	NCFT	No	CMB SVC 8X5XNBD
CON-NCFW-HXAF240C	NCFW	No	CMB SVC SW
Note: For PID HXAF240C-M6SX, select Service SKU with HXAF24CX suffix (Example: CON-NCF4P-HXAF24CX)			
For PID HX240C-M6SX, select Service SKU with HX240CMX suffix (Example: CON-NCF4P-HX240CMX)			

Drive Retention Service

With the Cisco Drive Retention Service, you can obtain a new disk drive in exchange for a faulty drive without returning the faulty drive.

Sophisticated data recovery techniques have made classified, proprietary, and confidential information vulnerable, even on malfunctioning disk drives. The Drive Retention service enables you to retain your drives and ensures that the sensitive data on those drives is not compromised, which reduces the risk of any potential liabilities. This service also enables you to comply with regulatory, local, and federal requirements.

If your company has a need to control confidential, classified, sensitive, or proprietary data, you might want to consider one of the Drive Retention Services listed in the above tables (where available)



NOTE: Cisco does not offer a certified drive destruction service as part of this service.

Local Language Technical Support

Where available, and subject to an additional fee, local language support for calls on all assigned severity levels may be available for specific product(s) - see tables above.

For a complete listing of available services for Cisco Unified Computing System, see the following URL:

http://www.cisco.com/en/US/products/ps10312/serv_group_home.html

SUPPLEMENTAL MATERIAL

Hyperconverged Systems

Cisco HyperFlex Systems let you unlock the full potential of hyperconvergence and adapt IT to the needs of your workloads. The systems use an end-to-end software-defined infrastructure approach, combining software-defined computing in the form of Cisco HyperFlex HX-Series nodes; software-defined storage with the powerful Cisco HX Data Platform; and software-defined networking with the Cisco UCS fabric that will integrate smoothly with Cisco Application Centric Infrastructure (Cisco ACI). Together with a single point of connectivity and management, these technologies deliver a preintegrated and adaptable cluster with a unified pool of resources that you can quickly deploy, adapt, scale, and manage to efficiently power your applications and your business.

Figure 9 & Figure 10 show a small footprint cluster.

Figure 9 Small Footprint Cluster Using HX240C M6 All NVMe/All Flash/Hybrid Server Nodes With Data Center Fabric Interconnect Deployment Mode

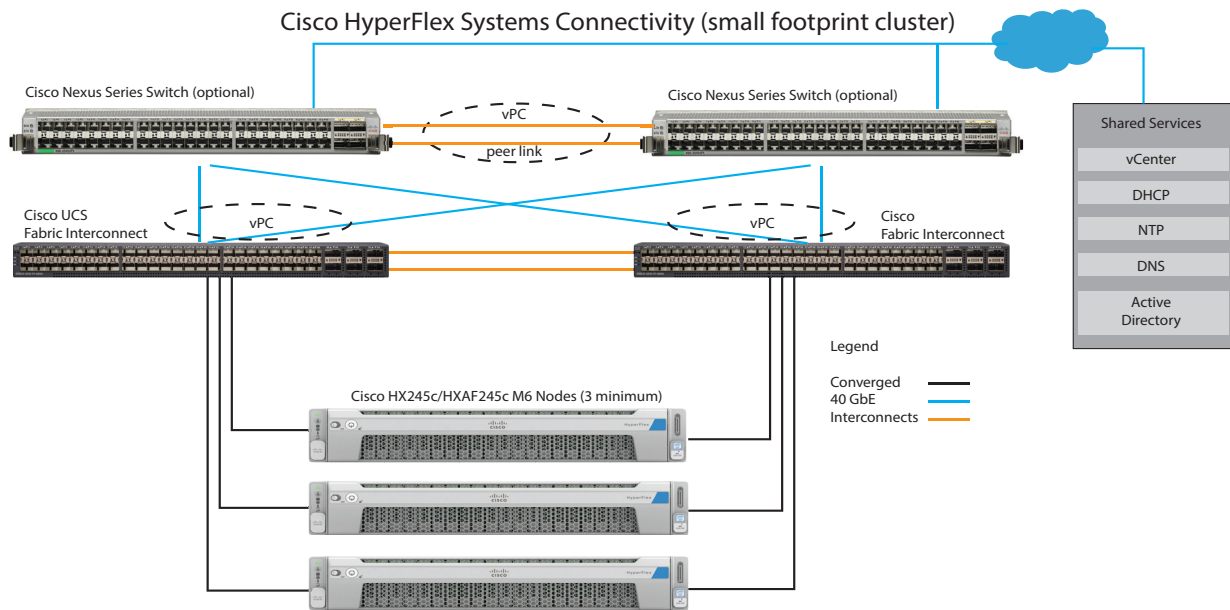
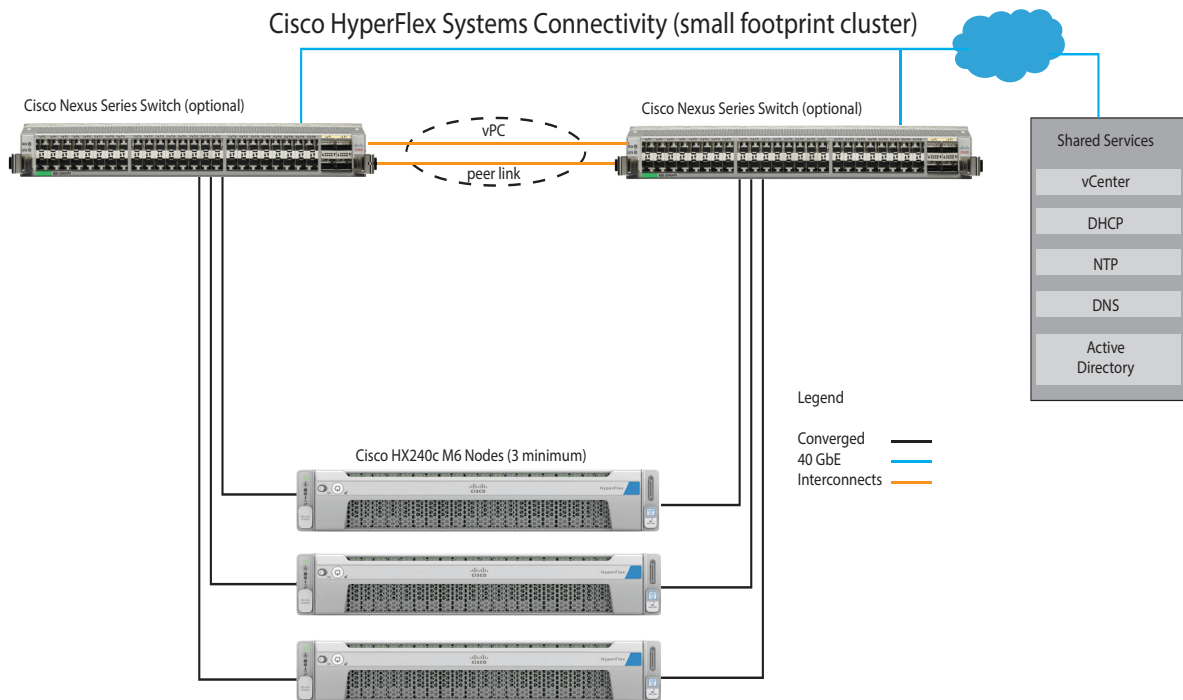

Figure 10 Small Footprint Cluster Using HX240C M6 All Flash/Hybrid Server Nodes Data Center Without Fabric Interconnect Deployment Mode



10 or 25 Gigabit Ethernet Dual Switch Topology

Dual switch configuration provides a slightly more complex topology with full redundancy that protects against: switch failure, link failure, and port failure. It requires two switches that may be standalone or stacked, and two 10/25GE ports, one 1GE port for CIMC management, and one Cisco VIC 1467 per server. Trunk ports are the only supported network port configuration. refer [10/25 Gigabit Ethernet Switch Configuration Guidelines](#) for more information.

To deploy this topology, select connectivity mode from [Table 14](#).

Figure 11 Physical cabling for the 10/25GE Dual Switch Topology. Detailed diagrams for network topologies can be found in the [pre-installation checklist](#).

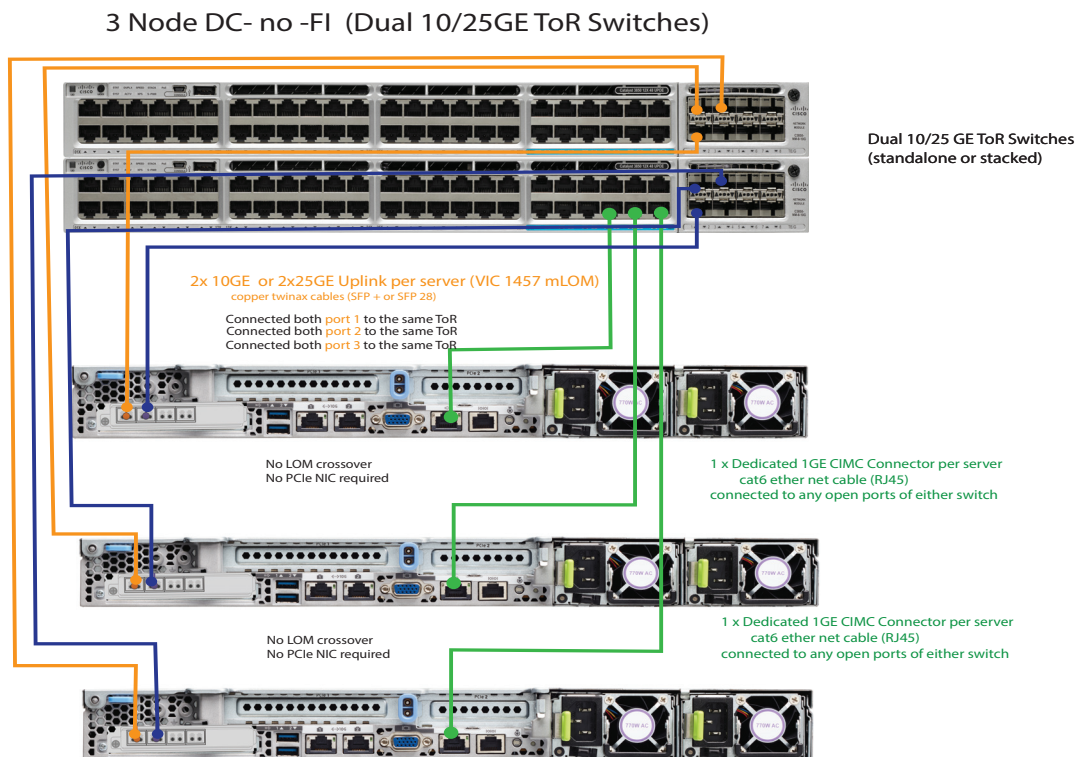

NIC Based 10 or 25 Gigabit Ethernet Dual Switch Topology (quad port)

Dual switch configuration provides a slightly more complex topology with full redundancy that protects against: switch failure, link failure, and port failure. It requires two switches that may be standalone or stacked, and four 10/25GE ports, one 1GE port for CIMC management, and 1 x quad port NIC per server. Trunk ports are the only supported network port configuration. refer [10/25 Gigabit Ethernet Switch Configuration Guidelines](#) for more information.

To deploy this topology, select connectivity mode from [Table 14](#).

Figure 12 Physical cabling for the Quad Port NIC Based 10/25GE Dual Switch Topology.

3 or greater Node Edge/DC-no-FI - Dual 10/25GE

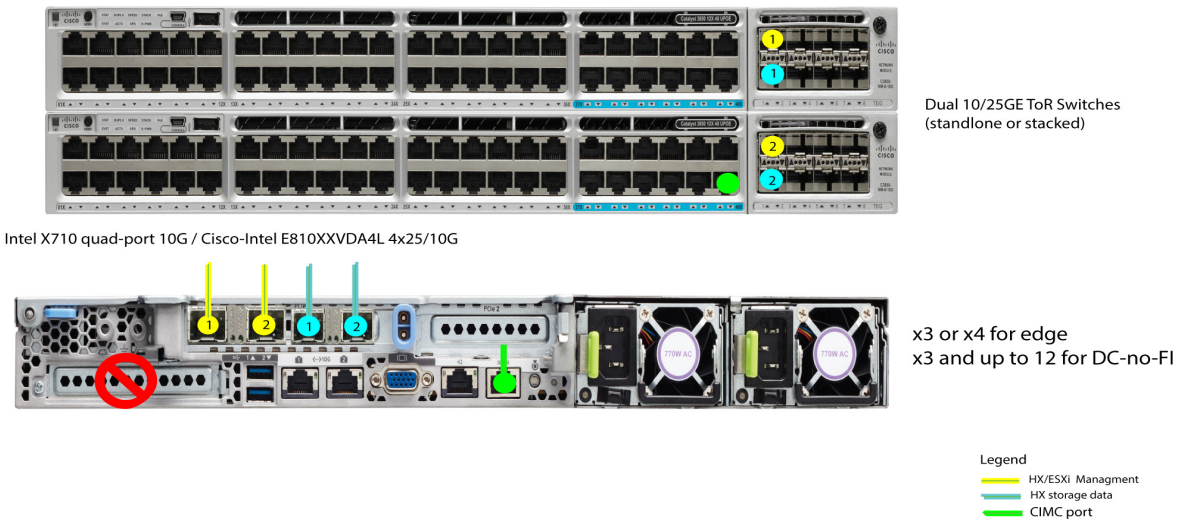

NIC Based 10 or 25 Gigabit Ethernet Dual Switch Topology (dual port)

Dual switch configuration provides a slightly more complex topology with full redundancy that protects against: switch failure, link failure, and port failure. It requires two switches that may be standalone or stacked, and four 10/25GE ports, one 1GE port for CIMC management, and 2 x dual port NIC per server. Trunk ports are the only supported network port configuration. refer [10/25 Gigabit Ethernet Switch Configuration Guidelines](#) for more information.

To deploy this topology, select from [Table 4](#).

Figure 13 Physical cabling for the Dual Port NIC Based 10/25GE Dual Switch Topology.

3 or greater Node Edge/DC-no-FI - Dual 10/25GE

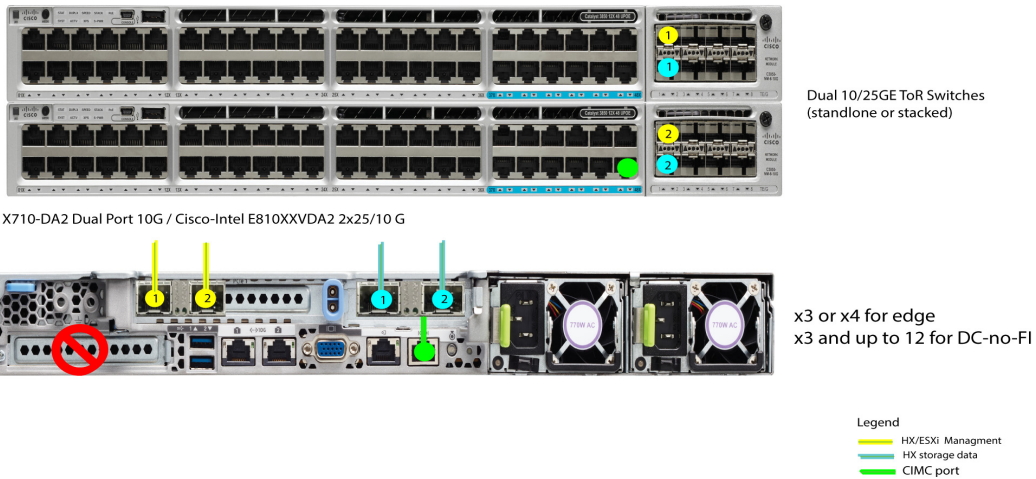

Serial Port Details

The pinout details of the rear RJ-45 serial port connector are shown in [Figure 14](#).

Figure 14 Serial Port (Female RJ-45 Connector) Pinout

Serial Port (RJ-45 Female Connector)

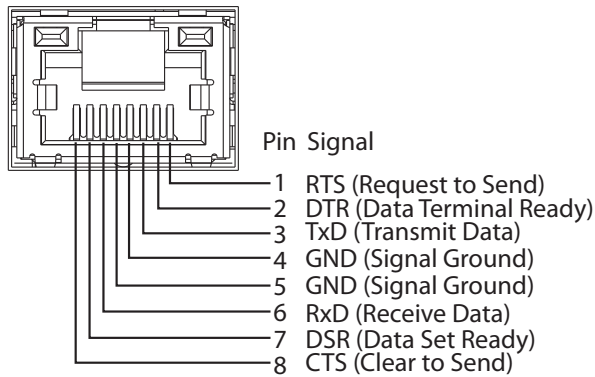

KVM Cable

The KVM cable provides a connection into the server, providing a DB9 serial connector, a VGA connector for a monitor, and dual USB 2.0 ports for a keyboard and mouse. With this cable, you can create a direct connection to the operating system and the BIOS running on the server.

The KVM cable ordering information is listed in [Table 41](#).

Table 41 KVM Cable

Product ID (PID)	PID Description
N20-BKVM	KVM local IO cable for UCS servers console port

Figure 15 KVM Cable

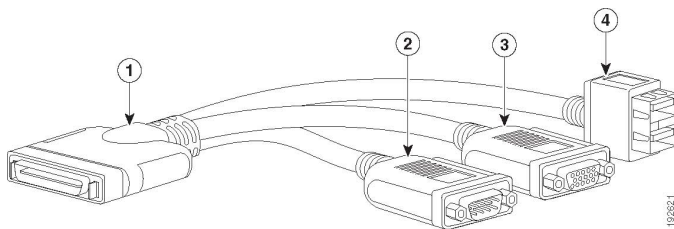

1	Connector (to server front panel)	3	VGA connector (for a monitor)
2	DB-9 serial connector	4	Two-port USB 2.0 connector (for a mouse and keyboard)

Chassis

An internal view of the HX240C M6 All NVMe/All Flash/Hybrid Server Nodes chassis with the top cover removed is shown in [Figure 16](#).

Figure 16 HX240C M6 All NVMe/All Flash/Hybrid Server Nodes With Top Cover Off

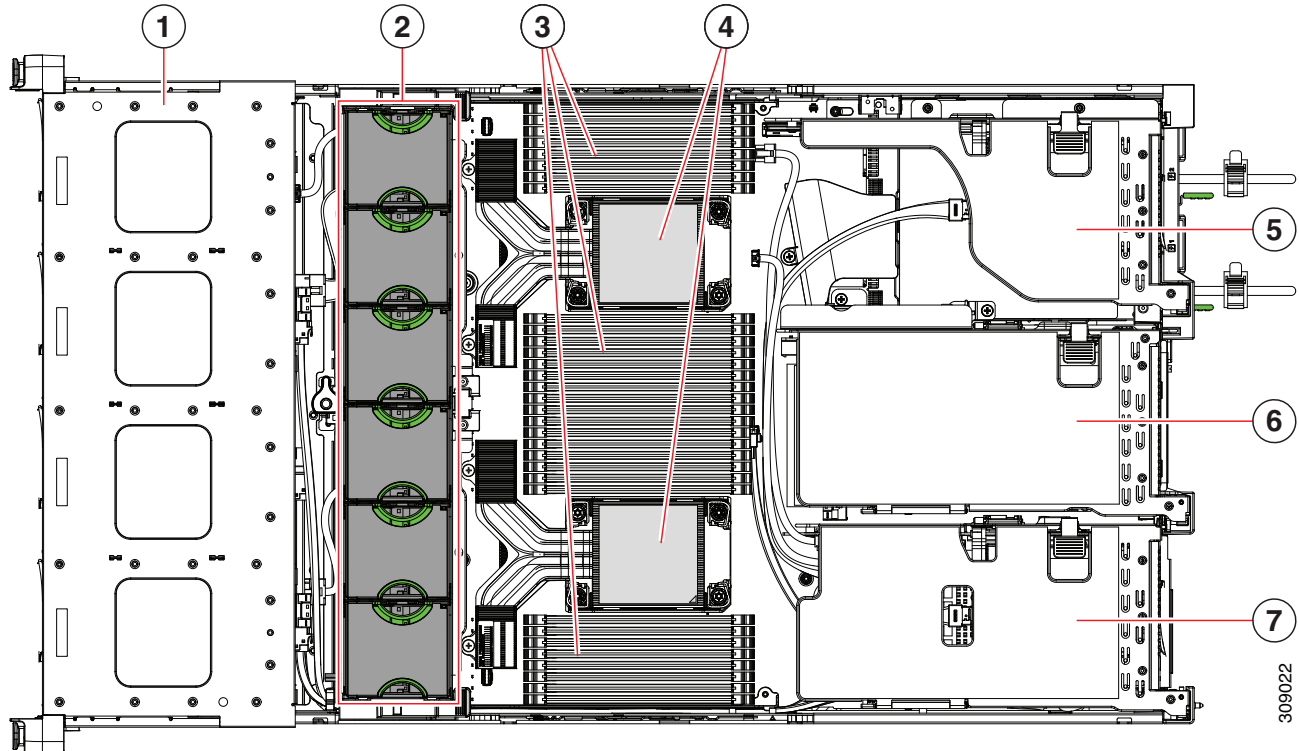

309022

1	Front-loading drive bays	2	Cooling fan modules (six, hot-swappable)
3	DIMM sockets on motherboard (16 per CPU) An air baffle rests on top of the DIMMs and CPUs when the server is operating. The air baffle is not displayed in this illustration.	4	CPU sockets CPU 2 is at the top and CPU 1 is at the bottom.
5	PCIe riser 3 (PCIe slots 7 and 8 numbered from bottom to top), with the following options: <ul style="list-style-type: none"> ■ 3A (Default Option)—Slots 7 (x24 mechanical, x8 electrical), and 8 (x24 mechanical, x8 electrical). Both slots can accept a full height, full length GPU card. ■ 3B (Storage Option)—Slots 7 (x24 mechanical, x4 electrical) and 8 (x24 mechanical, x4 electrical). Both slots can accept 2.5-inch SFF universal HDDs. ■ 3C (GPU Option)—Slots 7 (x24 mechanical, x16 electrical) and 8 empty (NCSI support limited to one slot at a time). Slot 7 can support a full height, full length, double-wide GPU card. 	6	PCIe riser 2 (PCIe slots 4, 5, 6 numbered from bottom to top), with the following options: <ul style="list-style-type: none"> ■ 2A (Default Option)—Slot 4 (x24 mechanical, x8 electrical) supports full height, ¾ length card; Slot 5 (x24 mechanical, x16 electrical) supports full height, full length GPU card; Slot 6 (x24 mechanical, x8 electrical) supports full height, full length card.

7	<p>PCIe riser 1 (PCIe slot 1, 2, 3 numbered bottom to top), with the following options:</p> <ul style="list-style-type: none">■ 1A (Default Option)—Slot 1 (x24 mechanical, x8 electrical) supports full height, ¾ length card; Slot 2 (x24 mechanical, x16 electrical) supports full height, full length GPU card; Slot 3 (x24 mechanical, x8 electrical) supports full height, full length card.■ 1B (Storage Option)—Slot 1 is reserved; Slot 2 (x4 electrical), supports 2.5-inch SFF universal HDD; Slot 3 (x4 electrical), supports 2.5-inch SFF universal HDD	-	
---	---	---	--

Risers

Figure 17 shows the locations of the PCIe riser connectors on the HX240C M6 All NVMe/All Flash/Hybrid Server Nodes motherboard.

Figure 17 HX240C M6 All NVMe/All Flash/Hybrid Server Nodes Riser Connector Locations

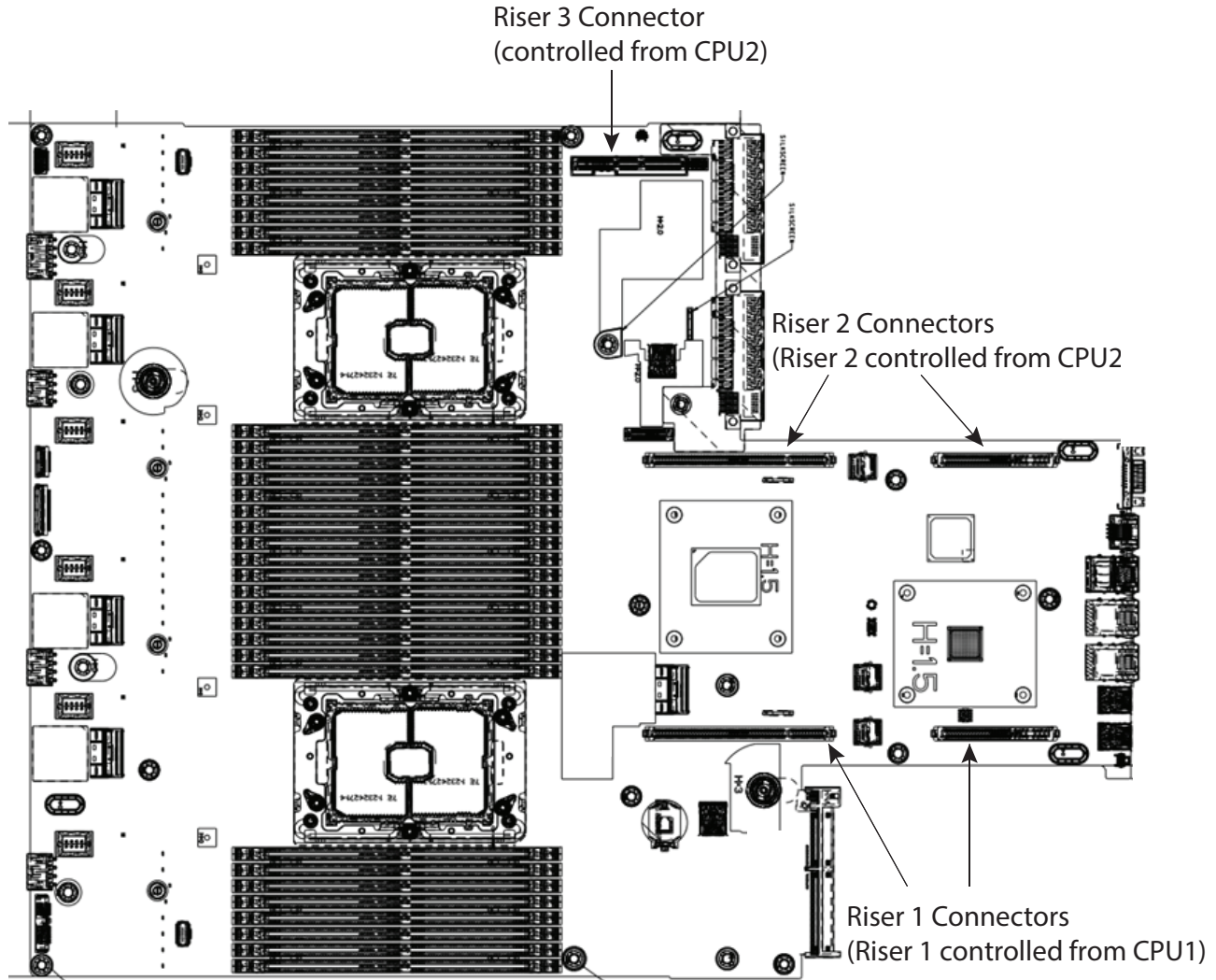
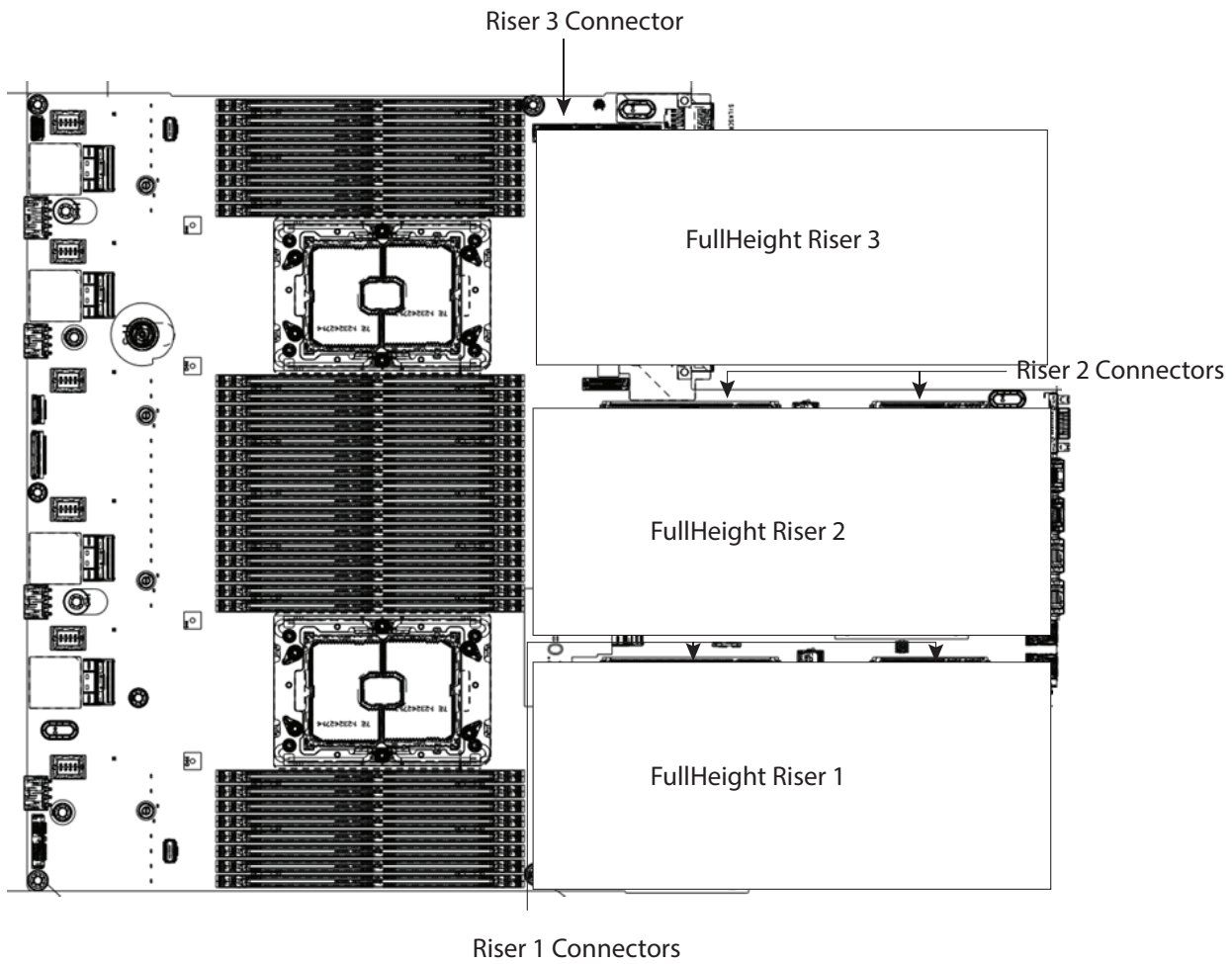

Figure 18 shows the locations of the PCIe riser connectors on the HX240C M6 All NVMe/All Flash/Hybrid Server Nodes motherboard.

Figure 18 HX240C M6 All NVMe/All Flash/Hybrid Server Nodes Riser Connector Locations



Riser Card Configuration and Options

The riser card locations are shown in *Figure 19*.

Figure 19 Riser Card Locations

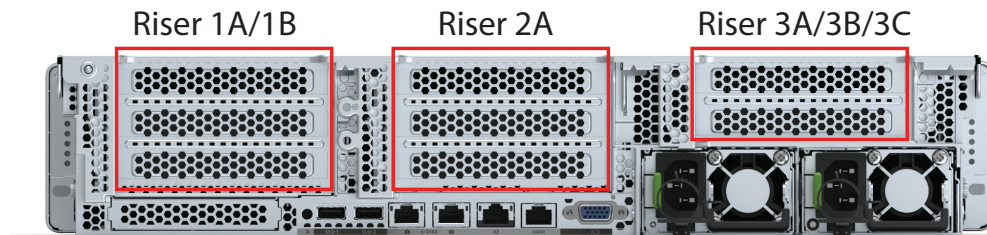

Riser 1A

Riser 1A mechanical information is shown in *Figure 20*.

Figure 20 Riser Card 1A

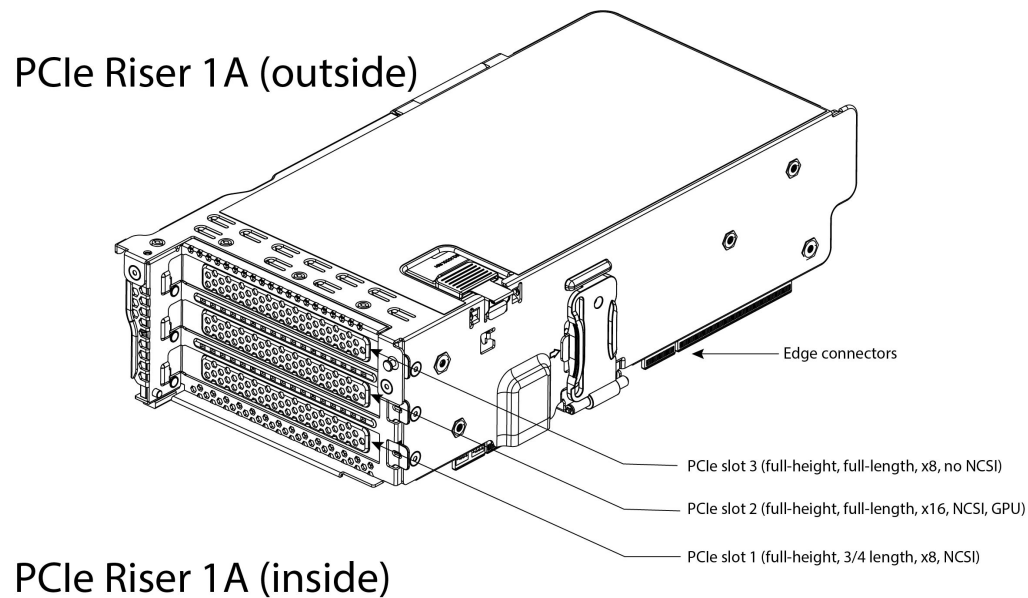

Riser 1B

Riser 1B mechanical information is shown in [Figure 21](#).

Figure 21 Riser Card 1B

PCIe Riser 1B (outside)

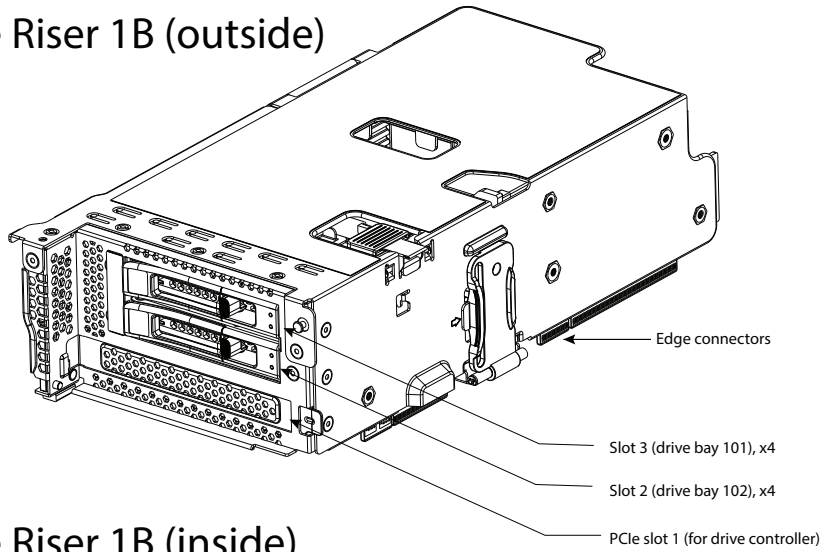

PCIe Riser 1B (inside)

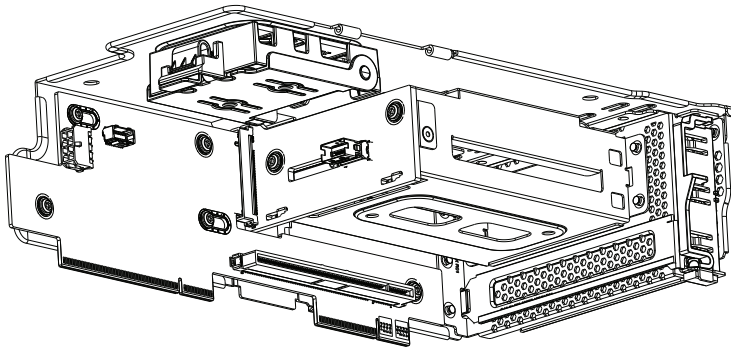

Riser 2A

Riser 2A mechanical information is shown in [Figure 22](#).

Figure 22 Riser Card 2A

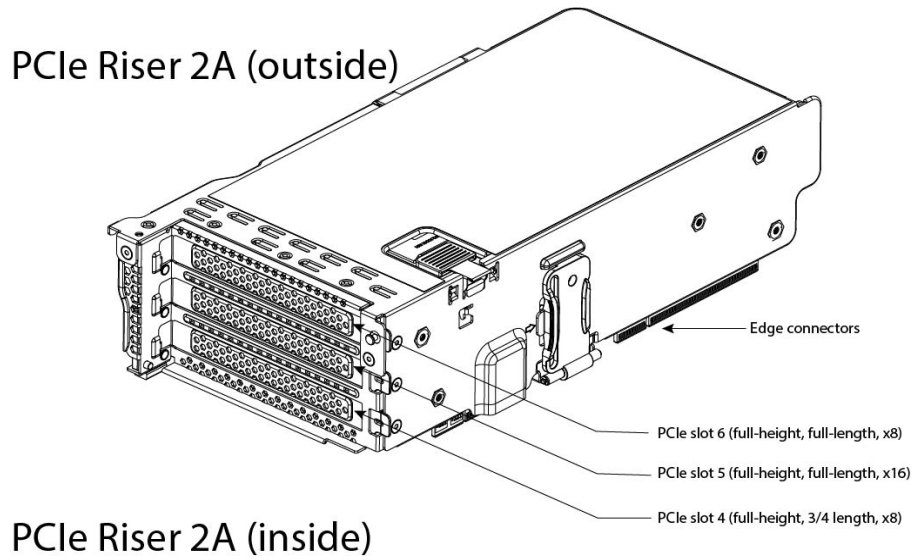

PCIe Riser 2A (inside)

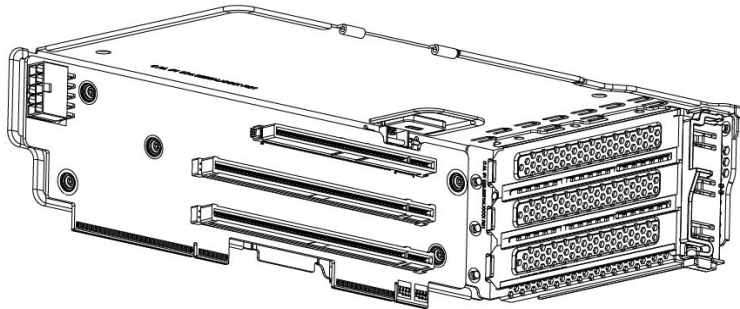

Riser 3A

Riser 3A mechanical information is shown in [Figure 23](#).

Figure 23 Riser Card 3A

PCIe Riser 3A (outside)

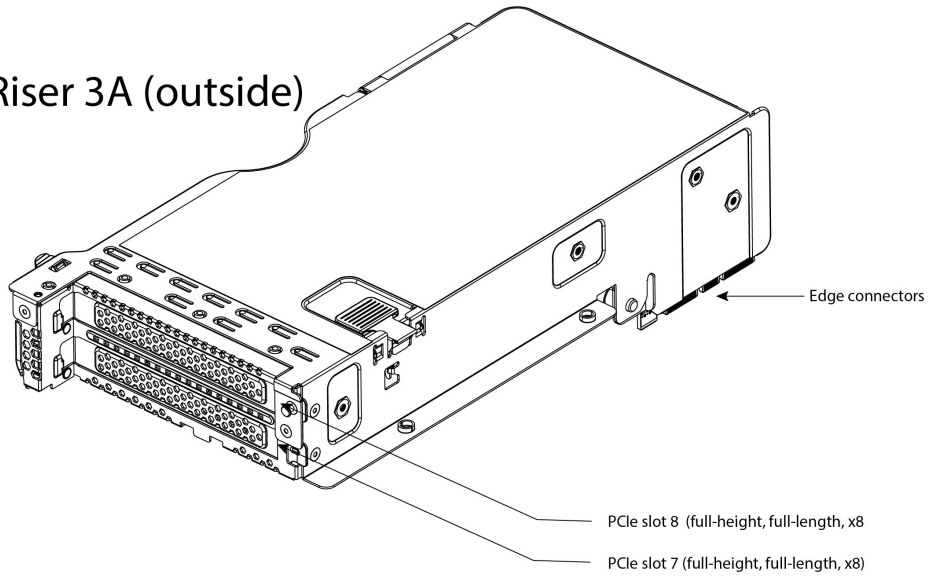

PCIe Riser 3A (inside)

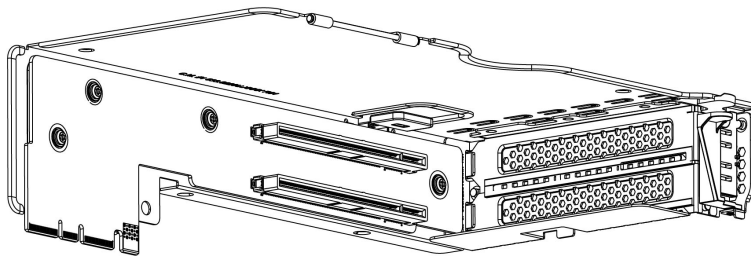

Riser 3B

Riser 3B mechanical information is shown in [Figure 24](#).

Figure 24 Riser Card 3B

PCIe Riser 3B (outside)

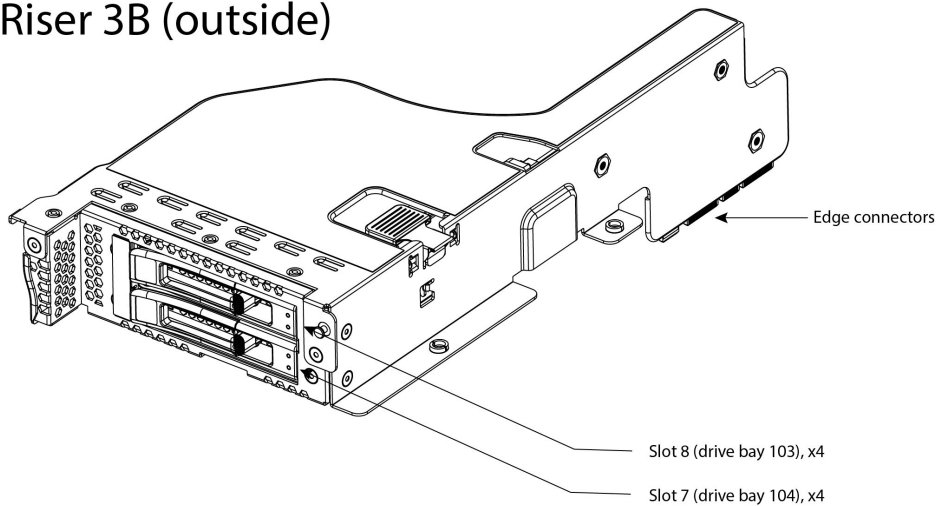

PCIe Riser 3B (inside)

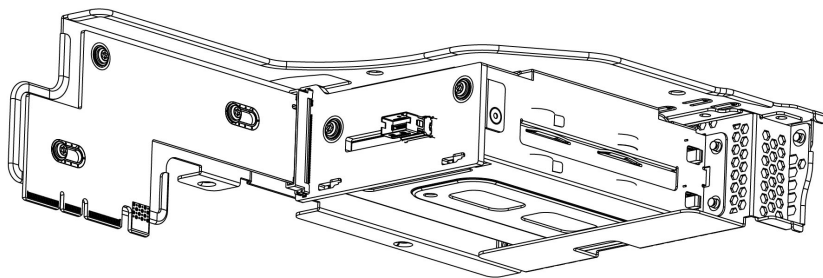

Riser 3C

Riser 3C mechanical information is shown in [Figure 25](#).

Figure 25 Riser Card 3C

PCIe Riser 3C (outside)

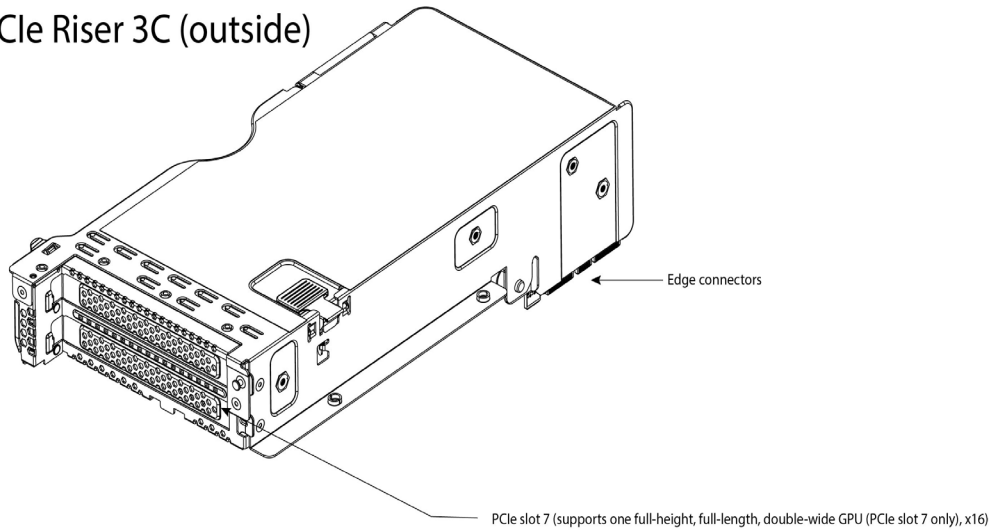

PCIe Riser 3C (inside)

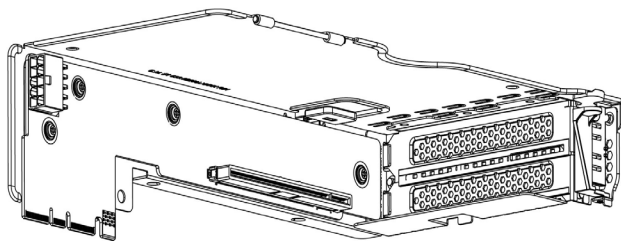

SPARE PARTS

This section lists the upgrade and service-related parts for the HyperFlex HX240C M6 All NVMe/All Flash/Hybrid Server Nodes. Some of these parts are configured with every server.



NOTE: Some spare parts you order may also require accessories for full functionality. For example, drives or RAID controllers may need accompanying cables. CPUs may need heatsinks, thermal paste, and installation tools. The spares and their accessory parts are listed in [Table 42](#).

Table 42 Spare Parts

Product ID (PID)	PID Description
KVM Cable	
N20-BKVM=	KVM local IO cable for UCS servers console port
Risers	
HX-RIS1A-240M6=	C240 M6 Riser1A; (x8;x16x, x8); StBkt; (CPU1)
HX-RIS1B-240M6=	C240 M6 Riser1B; 2xHDD; x16; StBkt; (CPU1)
UCSC-RIS2A-240M6=	C240 M6 Riser2A; (x8;x16;x8);StBkt; (CPU2)
HX-RIS3A-240M6=	C240 M6 Riser3A (x8;x8); StBkt; (CPU2)
HX-RIS3B-240M6=	C240 M6 Riser 3B; 2xHDD; StBkt; (CPU2)
HX-RIS3C-240M6=	C240 M6 Riser 3C
UCSC-FBRS2-C240M6=	C240M6 2U Riser2 Filler Blank
UCSC-FBRS3-C240M6=	C240M6 2U Riser3 Filler Blank
CPUs	
<p>Note: If you are ordering a second CPU, see the CPU Accessories section in this table for additional parts you may need to order for the second CPU.</p>	
8000 Series Processors	
HX-CPU-I8380=	Intel 8380 2.3GHz/270W 40C/60MB DDR4 3200MHz
HX-CPU-I8368=	Intel 8368 2.4GHz/270W 38C/57MB DDR4 3200MHz
HX-CPU-I8362=	Intel 8362 2.8GHz/265W 32C/48MB DDR4 3200MHz-
HX-CPU-I8360Y=	Intel 8360Y 2.4GHz/250W 36C/54MB DDR4 3200MHz

Table 42 Spare Parts (continued)

Product ID (PID)	PID Description
HX-CPU-I8358P=	Intel 8358P 2.6GHz/240W 32C/48MB DDR4 3200MHz
HX-CPU-I8358=	Intel 8358 2.6GHz/250W 32C/48MB DDR4 3200MHz
HX-CPU-I8352Y=	Intel 8352Y 2.2GHz/205W 32C/48MB DDR4 3200MHz
HX-CPU-I8352V=	Intel 8352V 2.1GHz/195W 36C/54MB DDR4 2933MHz
HX-CPU-I8352M=	Intel 8352M 2.3GHz/185W 32C/48MB DDR4 3200MHz
HX-CPU-I8352S=	Intel 8352S 2.2GHz/205W 32C/48MB DDR4 3200MHz
HX-CPU-I8351N=	Intel 8351N 2.4GHz/225W 36C/54MB DDR4 2933MHz
6000 Series Processors	
HX-CPU-I6354=	Intel 6354 3.0GHz/205W 18C/39MB DDR4 3200MHz
HX-CPU-I6348=	Intel 6348 2.6GHz/235W 28C/42MB DDR4 3200MHz
HX-CPU-I6346=	Intel 6346 3.1GHz/205W 16C/36MB DDR4 3200MHz
HX-CPU-I6342=	Intel 6342 2.8GHz/230W 24C/36MB DDR4 3200MHz
HX-CPU-I6338N=	Intel 6338T 2.1GHz/165W 24C/36MB DDR4 3200MHz
HX-CPU-I6338T=	Intel 6338N 2.2GHz/185W 32C/48MB DDR4 2667MHz
HX-CPU-I6338=	Intel 6338 2.0GHz/205W 32C/48MB DDR4 3200MHz
HX-CPU-I6336Y=	Intel 6336Y 2.4GHz/185W 24C/36MB DDR4 3200MHz
HX-CPU-I6334=	Intel 6334 3.6GHz/165W 8C/18MB DDR4 3200MHz
HX-CPU-I6330N=	Intel 6330N 2.2GHz/165W 28C/42MB DDR4 2667MHz
HX-CPU-I6330=	Intel 6330 2.0GHz/205W 28C/42MB DDR4 2933MHz
HX-CPU-I6326=	Intel 6326 2.9GHz/185W 16C/24MB DDR4 3200MHz
HX-CPU-I6314U=	Intel 6314U 2.3GHz/205W 32C/48MB DDR4 3200MHz
HX-CPU-I6312U=	Intel 6312U 2.4GHz/185W 24C/36MB DDR4 3200MHz
5000 Series Processors	
HX-CPU-I5320T=	Intel 5320T 2.3GHz/150W 20C/30MB DDR4 2933MHz
HX-CPU-I5320=	Intel 5320 2.2GHz/185W 26C/39MB DDR4 2933MHz
HX-CPU-I5318N=	Intel 5318Y 2.1GHz/165W 24C/36MB DDR4 2933MHz
HX-CPU-I5318S=	Intel 5318S 2.1GHz/165W 24C/36MB DDR4 2933MHz
HX-CPU-I5318Y=	Intel 5318N 2.1GHz/150W 24C/36MB DDR4 2667MHz
HX-CPU-I5317=	Intel 5317 3.0GHz/150W 12C/18MB DDR4 2933MHz

Table 42 Spare Parts (continued)





Product ID (PID)	PID Description
HX-CPU-I5315Y=	Intel 5315Y 3.2GHz/140W 8C/12MB DDR4 2933MHz
4000 Series Processors	
HX-CPU-I4316=	Intel 4316 2.3GHz/150W 20C/30MB DDR4 2667MHz
HX-CPU-I4314=	Intel 4314 2.4GHz/135W 16C/24MB DDR4 2667MHz
HX-CPU-I4310T=	Intel 4310T 2.3GHz/105W 10C/15MB DDR4 2667MHz
HX-CPU-I4310=	Intel 4310 2.1GHz/120W 12C/18MB DDR4 2667MHz
HX-CPU-I4309Y=	Intel 4309Y 2.8GHz/105W 8C/12MB DDR4 2667MHz
CPU Accessories	
UCS-CPU-TIM=  Note: This part is included with the purchase of spare CPU.Can be ordered separately.	Single CPU thermal interface material syringe for M5 server HS seal ¹
UCS-M6-CPU-CAR=  Note: This part is included with the purchase of spare CPU.Can be ordered separately.	Spare CPU Carrier for M6
UCSX-HSCK=  Note: This part is included with the purchase of spare CPU.Can be ordered separately.	UCS CPU/Heatsink Cleaning Kit, for up to 4 CPU/heatsink sets
UCS-CPUAT=  Note: This part is included with the purchase of spare CPU.Can be ordered separately.	CPU Assembly Tool for Servers

Table 42 Spare Parts (continued)



Product ID (PID)	PID Description
UCSC-HSHP-240M6=  Note: Order this Heatsink, if you are adding additional CPU/spare CPU	Heatsink for 2U SFF M6 PCIe SKU
UCSC-FAN-C240M6=	C240M6 2U Fan
Memory	
HX-MR-X16G1RW=	16 GB RDIMM SRx4 3200 (8Gb)
HX-MR-X32G1RW=	32 GB RDIMM SRx4 3200 (16Gb)
HX-MR-X32G2RW=	32 GB RDIMM DRx4 3200 (8Gb)
HX-MR-X64G2RW=	64 GB RDIMM DRx4 3200 (16Gb)
HX-ML-128G4RW=	128 GB LRDIMM QRx4 3200 (16Gb)
HX-ML-256G8RW=	256 GB LRDIMM 8Rx4 3200 (16Gb) (3DS)
Intel® Optane™ Persistent Memory (PMem)	
HX-MP-128GS-B0=	Intel® Optane™ Persistent Memory, 128GB, 3200 MHz
HX-MP-256GS-B0=	Intel® Optane™ Persistent Memory, 256 GB, 3200 MHz
HX-MP-512GS-B0=	Intel® Optane™ Persistent Memory, 512 GB, 3200 MHz
DIMM Blank	
UCS-DIMM-BLK=	UCS DIMM Blank
Drives  Note: When ordering additional SAS/SATA or NVMe front or rear drives, you may need to order a cable to connect from the drive to the motherboard. See the Drive Cables section in this table.	
HXAF240M6SN (All NVMe)	
Front Capacity Drive	
HX-NVMEI4-I1920=	1.9TB 2.5in U.2 Intel P5500 NVMe High Perf Medium Endurance
HX-NVMEI4-I3840=	3.8TB 2.5in U.2 Intel P5500 NVMe High Perf Medium Endurance
HX-NVMEI4-I7680=	7.6TB 2.5in U.2 Intel P5500 NVMe High Perf Medium Endurance
HX-NVMEM6-W15300=	15.3TB 2.5in U.2 WD SN840 NVMe Extreme Perf. High Endurance (HyperFlex Release 5.0 (2a) and later)

Table 42 Spare Parts (continued)

Product ID (PID)	PID Description
HX-NVME4-15360=	15.3TB 2.5in U.2 15mm P5520 Hg Perf Med End NVMe (HyperFlex Release 5.0 (2b + Catalog) and later)
HX-NVME4-1920=	1.9TB 2.5in U.2 15mm P5520 Hg Perf Med End NVMe (HyperFlex Release 5.0(2b) and later)
HX-NVME4-3840=	3.8TB 2.5in U.2 15mm P5520 Hg Perf Med End NVMe (HyperFlex Release 5.0(2b) and later)
HX-NVME4-7680=	7.6TB 2.5in U.2 15mm P5520 Hg Perf Med End NVMe (HyperFlex Release 5.0(2b) and later)
Rear Capacity Drive	
HX-NVMEI4-I1920=	1.9TB 2.5in U.2 Intel P5500 NVMe High Perf Medium Endurance
HX-NVMEI4-I3840=	3.8TB 2.5in U.2 Intel P5500 NVMe High Perf Medium Endurance
HX-NVMEI4-I7680=	7.6TB 2.5in U.2 Intel P5500 NVMe High Perf Medium Endurance
HX-NVMEM6-W15300=	15.3TB 2.5in U.2 WD SN840 NVMe Extreme Perf. High Endurance (HyperFlex Release 5.0 (2a) and later)
HX-NVME4-15360=	15.3TB 2.5in U.2 15mm P5520 Hg Perf Med End NVMe (HyperFlex Release 5.0 (2b + Catalog) and later)
HX-NVME4-1920=	1.9TB 2.5in U.2 15mm P5520 Hg Perf Med End NVMe (HyperFlex Release 5.0(2b) and later)
HX-NVME4-3840=	3.8TB 2.5in U.2 15mm P5520 Hg Perf Med End NVMe (HyperFlex Release 5.0(2b) and later)
HX-NVME4-7680=	7.6TB 2.5in U.2 15mm P5520 Hg Perf Med End NVMe (HyperFlex Release 5.0(2b) and later)
Front Cache Drive	
HX-NVMEXPB-I375=	375GB 2.5in Intel Optane NVMe Extreme Performance SSD (Mixed drive support with HyperFlex Release 5.0(2b))
HX-NVMEXP-I400=	400GB 2.5in U.2 15mm P5800X Optane Ext Perf NVMe (30/100X) (HyperFlex Release 5.0(2b) and later)
HX-NVMEM6-W1600=	1.6TB 2.5in U.2 WD SN840 NVMe Extreme Perf. High Endurance (HyperFlex Release 5.0(2b); Mixed drive support available)
Front System Drive	
HX-NVME2H-I1000=	Cisco 2.5" U.2 1,0 TB Intel P4510 NVMe High Perf. Value Endurance
HX-NVME4-1920=	1.9TB 2.5in U.2 15mm P5520 Hg Perf Med End NVMe (HyperFlex Release 5.0(2b) and later)
Boot Drive	
HX-M2-240GB=	240GB SATA M.2

Table 42 Spare Parts (continued)

Product ID (PID)	PID Description
HX-M2-HWRAID=	Cisco Boot optimized M.2 Raid controller
HXAF240M6SX (All flash)	
Front Capacity Drive	
HX-SD19T61X-EV=	1.9TB 2.5 inch Enterprise Value 6G SATA SSD
HX-SD38T61X-EV=	3.8TB 2.5 inch Enterprise Value 6G SATA SSD
HX-SD76T61X-EV=	7.6TB 2.5 inch Enterprise Value 6G SATA SSD
HX-SD960G6S1X-EV=	960GB 2.5 inch Enterprise Value 6G SATA SSD
HX-SD19T6S1X-EV=	1.9TB 2.5 inch Enterprise Value 6G SATA SSD
HX-SD38T6S1X-EV=	3.8TB 2.5 inch Enterprise Value 6G SATA SSD
HX-SD76T6S1X-EV=	7.6TB 2.5 inch Enterprise Value 6G SATA SSD
Rear Capacity Drive	
HX-SD19T61X-EV=	1.9TB 2.5 inch Enterprise Value 6G SATA SSD
HX-SD38T61X-EV=	3.8TB 2.5 inch Enterprise Value 6G SATA SSD
HX-SD76T61X-EV=	7.6TB 2.5 inch Enterprise Value 6G SATA SSD
HX-SD960G6S1X-EV=	960GB 2.5 inch Enterprise Value 6G SATA SSD
HX-SD19T6S1X-EV=	1.9TB 2.5 inch Enterprise Value 6G SATA SSD
HX-SD38T6S1X-EV=	3.8TB 2.5 inch Enterprise Value 6G SATA SSD
HX-SD76T6S1X-EV=	7.6TB 2.5 inch Enterprise Value 6G SATA SSD
Front SED Capacity Drive	
HX-SD960GBM2NK9=	960GB Enterprise value SATA SSD (1X, SED)
HX-SD38TBEM2NK9=	3.8TB Enterprise value SATA SSD (1X, SED)
HX-SD76TBEM2NK9=	7.6TB Enterprise value SATA SSD (1X, SED)
HX-SD960GBKNK9=	960GB Enterprise Value SAS SSD (1X FWPD, SED)
HX-SD38TBKNK9=	3.8TB Enterprise Value SAS SSD (1X FWPD, SED)
HX-SD76TBKNK9=	7.6TB Enterprise value SAS SSD (1 DWPD, SED-FIPS)
Rear SED Capacity Drive	
HX-SD960GBM2NK9=	960GB Enterprise value SATA SSD (1X, SED)
HX-SD38TBEM2NK9=	3.8TB Enterprise value SATA SSD (1X, SED)
HX-SD76TBEM2NK9=	7.6TB Enterprise value SATA SSD (1X, SED)

Table 42 Spare Parts (continued)

Product ID (PID)	PID Description
HX-SD960GBKNK9=	960GB Enterprise Value SAS SSD (1X FWPD, SED)
HX-SD38TBKNK9=	3.8TB Enterprise Value SAS SSD (1X FWPD, SED)
HX-SD76TBKNK9=	7.6TB Enterprise value SAS SSD (1 DWPD, SED-FIPS)
Front Cache Drive	
HX-SD800GK3X-EP=	800GB 2.5in Enterprise Performance 12G SAS SSD(3X endurance)
HX-NVMEXPB-I375=	375GB 2.5in Intel Optane NVMe Extreme Performance SSD (Mixed drive support with HyperFlex Release 5.0(2b))
HX-NVMEXP-I400=	400GB 2.5in U.2 15mm P5800X Optane Ext Perf NVMe (30/100X) (HyperFlex Release 5.0(2b) and later)
HX-NVMEM6-W1600=	1.6TB 2.5in U.2 WD SN840 NVMe Extreme Perf. High Endurance (HyperFlex Release 5.0(2b); Mixed drive support available)
Front SED Cache Drive	
HX-SD800GBKNK9=	800GB Enterprise Performance SAS SSD (3X FWPD, SED)
Front System Drive	
HX-SD240GM1X-EV=	240GB 2.5 inch Enterprise Value 6G SATA SSD
Boot Drive	
HX-M2-240GB=	240GB SATA M.2
HX-M2-HWRAID=	Cisco Boot optimized M.2 Raid controller
HX240M6SX (Hybrid)	
Front Capacity Drive	
HX-HD12TB10K12N=	1.2 TB 12G SAS 10K RPM SFF HDD
HX-HD18TB10K4KN=	1.8TB 12G SAS 10K RPM SFF HDD (4K)
HX-HD24TB10K4KN=	2.4 TB 12G SAS 10K RPM SFF HDD (4K)
Rear Capacity Drive	
HX-HD12TB10K12N=	1.2 TB 12G SAS 10K RPM SFF HDD
HX-HD18TB10K4KN=	1.8TB 12G SAS 10K RPM SFF HDD (4K)
HX-HD24TB10K4KN=	2.4 TB 12G SAS 10K RPM SFF HDD (4K)
Front SED Capacity Drive	
HX-HD12T10NK9=	1.2TB 12G SAS 10K RPM SFF HDD (SED)
HX-HD24T10NK9=	2.4 TB 12G SAS 10K RPM SFF HDD (4K) SED

Table 42 Spare Parts (continued)

Product ID (PID)	PID Description
Rear SED Capacity Drive	
HX-HD12T10NK9=	1.2TB 12G SAS 10K RPM SFF HDD (SED)
HX-HD24T10NK9=	2.4 TB 12G SAS 10K RPM SFF HDD (4K) SED
Front Cache Drive	
HX-SD16TK3X-EP=	1.6TB 2.5in Enterprise Performance 12G SAS SSD(3X endurance)
Front SED Cache Drive	
HX-SD16TBKNK9=	1.6TB Enterprise performance SAS SSD (3X FWPD, SED)
Front System Drive	
HX-SD240GM1X-EV=	240GB 2.5 inch Enterprise Value 6G SATA SSD
Boot Drive	
HX-M2-240GB=	240GB SATA M.2
HX-M2-HWRAID=	Cisco Boot optimized M.2 Raid controller
Extender Board²	
UCSC-M2EXT-240M6=	C240M6 2U M.2 Extender board
Drive Cables	
CBL-SATA-C240M6=	SATA cable C240M6 (2U)
CBL-RSASR1B-240M6=	C240M6 2U x2 Rear SAS/SATA cable; (Riser1B)
CBL-RSASR3B-240M6=	C240M6 2U x2 Rear SAS/SATA cable; (Riser3B)
CBL-FNVME-240M6=	C240M6 2U x4 Front NVMe cable (two cables)
Drive Blanking Panel	
UCS-BBLKD-S2=	HX-Series M5 SFF drive blanking panel
RAID Controllers	
 <p>Note: When ordering additional RAID controllers, you may need to order a cable/supercap to connect from the RAID controller to the motherboard. See the RAID Controller Accessories section in this table.</p>	
HX-SAS-240M6=	Cisco 12G SAS HBA
RAID Controller Accessories	

Table 42 Spare Parts (continued)



Product ID (PID)	PID Description
CBL-SAS24-240M6=  Note: This cable set may be required, if you are adding SAS Drive and HX-SAS-240M6 (quantity 2)	C240M6 SAS cable 24 (2U); Pismo Rock
CBL-SAS12-240M6=  Note: This cable set may be required, if you are adding SAS Drive and HX-SAS-240M6 (quantity 1)	C240M6 SAS cable 12 (2U); (Pismo Rock/Beach)
PCI cards	
Virtual Interface Card (VICs)	
HX-PCIE-C100-04=	Cisco UCS VIC 1495 dual port 40/100G QSFP28 CNA PCIe
HX-PCIE-C25Q-04=	Cisco UCS VIC 1455 quad port 10/25G SFP28 PCIe
Network Interface Cards (NICs)	
1 Gb NICs	
HX-PCIE-IRJ45=	Intel i350 quad-port 1G copper PCIe
10 Gb NICs	
HX-PCIE-ID10GF=	Intel X710-DA2 Dual Port 10Gb SFP+ NIC
HX-PCIE-IQ10GF=	Intel X710 quad-port 10G SFP+ NIC
HX-P-ID10GC=	Cisco-Intel X710T2LG 2x10 GbE RJ45 PCIe NIC
25 Gb NICs	
HX-P-I8D25GF=	Cisco-Intel E810XXVDA2 2x25/10 GbE SFP28 PCIe NIC
HX-P-I8Q25GF=	Cisco-Intel E810XXVDA4L 4x25/10 GbE SFP28 PCIe NIC
GPU PCIe Cards	
 Note: If you are adding a GPU, you may need to add cables and other accessories for the GPU. See the GPU accessories and NVIDIA GPU Licenses section of this table.	
HX-GPU-A10=	TESLA A10, PASSIVE, 150W, 24GB
HX-GPU-A30=	Tesla A30

Table 42 Spare Parts (continued)





Product ID (PID)	PID Description
HX-GPU-A40 ⁼	TESLA A40 RTX, PASSIVE, 300W, 48GB
HX-GPU-A100-80 ⁵⁼	TESLA A100, PASSIVE, 300W, 80GB
HX-GPU-A16 ⁼	NVIDIA A16 PCIE 250W 4X16GB
GPU accessories	
UCS-M10CBL-C240M5  Note: You may need to order this cable if you are adding an A10/M10 GPU	C240M5 NVIDIA M10/A10 Cable
UCS-P100CBL-240M5  Note: You may need to order this cable if you are adding an A100 /A40/ A16/A30 GPU	C240M5 NVIDIA P100 /RTX /A100 /A40/ A16 /A30 Cable
CBL-GPU-C240M6  Note: You may need to order this power cable if you are adding an A10 GPU	Y TYPE GPU POWER Cable for A10 GPU, C240M6 and C245M6
UCSC-HSLP-M6 ⁼  Note: You may need to order this Heatsink if you are adding an GPUs	Heatsink for 1U/2U LFF/SFF GPU SKU
UCSC-ADGPU-240M6 ⁼  Note: You may need to order this Air Duct if you are adding an GPUs	C240M6 GPU Air Duct 2U (for DW only)

Table 42 Spare Parts (continued)

Product ID (PID)	PID Description
NVIDIA GPU Licenses	
 <p>Note: Order the GPU licenses if are adding the NVDIA GPUs</p> <ul style="list-style-type: none"> • If you already have a NVIDIA GPU and adding another one, or if you are replacing NVIDIA GPUs, then existing license should be fine. • if you don't have a GPU already installed, and you are adding the first one or two, you may need to order the license. 	
NV-VCS-1YR=	NVIDIA vCompute Server Subscription - 1 GPU - 1 Year
NV-VCS-3YR=	NVIDIA vCompute Server Subscription - 1 GPU - 3 Year
NV-VCS-5YR=	NVIDIA vCompute Server Subscription - 1 GPU - 5 Year
NV-VCS-R-1Y=	Renew NVIDIA vCompute Server Subscription - 1 GPU - 1 Year
NV-VCS-R-3Y=	Renew NVIDIA vCompute Server Subscription - 1 GPU - 3 Year
NV-VCS-R-5Y=	Renew NVIDIA vCompute Server Subscription - 1 GPU - 5 Year
NV-GRDWK-1-5S=	Quadro Perpetual Lic - NVIDIA vDWS 1CCU; 5Yr SUMS Req
NV-GRDVA-1-5S=	GRID Perpetual Lic - NVIDIA VDI APPs 1CCU; 5Yr SUMS Reqd
NV-GRDPC-1-5S=	GRID Perpetual Lic - NVIDIA VDI PC 1CCU; 5Yr SUMS Reqd
NV-GRD-EDP-5S=	EDU - Quadro Perpetual Lic - NVIDIA vDWS 1CCU; 5Yr SUMS Reqd
NV-GRID-WKP-5YR=	NVIDIA Quadro Production SUMS - vDWS 1CCU - 5 Year
NV-GRID-VAP-5YR=	NVIDIA GRID Production SUMS - VDI Apps 1CCU - 5 Year
NV-GRID-PCP-5YR=	NVIDIA GRID Production SUMS - VDI PC 1CCU - 5 Year
NV-GRID-EDP-5YR=	EDU - NVIDIA Quadro vDWS Production SUMS - 1CCU - 5 Year
NV-GRID-WKS-1YR=	NVIDIA Quadro SW Subscription - vDWS 1CCU - 1 Year
NV-GRID-WKS-3YR=	NVIDIA Quadro SW Subscription - vDWS 1CCU - 3 Year
NV-GRID-WKS-4YR=	NVIDIA Quadro SW Subscription - vDWS 1CCU - 4 Year
NV-GRID-WKS-5YR=	NVIDIA Quadro SW Subscription - vDWS 1CCU - 5 Year
NV-GRID-PCS-1YR=	NVIDIA GRID Software Subscription - VDI PC 1CCU - 1 Year
NV-GRID-PCS-3YR=	NVIDIA GRID Software Subscription - VDI PC 1CCU - 3 Year
NV-GRID-PCS-4YR=	NVIDIA GRID Software Subscription - VDI PC 1CCU - 4 Year
NV-GRID-PCS-5YR=	NVIDIA GRID Software Subscription - VDI PC 1CCU - 5 Year
NV-GRID-VAS-1YR=	NVIDIA GRID Software Subscription - VDI Apps 1CCU - 1 Year

Table 42 Spare Parts (continued)

Product ID (PID)	PID Description
NV-GRID-VAS-3YR=	NVIDIA GRID Software Subscription - VDI Apps 1CCU - 3 Year
NV-GRID-VAS-4YR=	NVIDIA GRID Software Subscription - VDI Apps 1CCU - 4 Year
NV-GRID-VAS-5YR=	NVIDIA GRID Software Subscription - VDI Apps 1CCU - 5 Year
NV-GRID-EDS-1YR=	EDU - NVIDIA Quadro vDWS SW Subscription - 1CCU - 1 Year
NV-GRID-EDS-3YR=	EDU - NVIDIA Quadro vDWS SW Subscription - 1CCU - 3 Year
NV-GRID-EDS-4YR=	EDU - NVIDIA Quadro vDWS SW Subscription - 1CCU - 4 Year
NV-GRID-EDS-5YR=	EDU - NVIDIA Quadro vDWS SW Subscription - 1CCU - 5 Year
NV-GRID-VAP-R-4Y=	Renew NVIDIA GRID vApps SUMS 1CCU 4 Year
NV-GRID-PCP-R-4Y=	Renew NVIDIA GRID vPC SUMS 1CCU 4 Year
NV-QUAD-WKP-R-4Y=	Renew NVIDIA Quadro vDWS SUMS 1CCU 4 Year
NV-QUAD-WKPE-R-4Y=	Renew NVIDIA Quadro vDWS SUMS 1CCU EDU 4 Year
NV-QUAD-WKS-R-1Y=	Renew NVIDIA Quadro vDWS Subscr 1CCU 1 Year
NV-QUAD-WKS-R-3Y=	Renew NVIDIA Quadro vDWS Subscr 1CCU 3 Year
NV-QUAD-WKS-R-4Y=	Renew NVIDIA Quadro vDWS Subscr 1CCU 4 Year
NV-QUAD-WKS-R-5Y=	Renew NVIDIA Quadro vDWS Subscr 1CCU 5 Year
NV-QUAD-WKSE-R-1Y=	Renew NVIDIA Quadro vDWS Subscr 1CCU EDU 1 Year
NV-QUAD-WKSE-R-3Y=	Renew NVIDIA Quadro vDWS Subscr 1CCU EDU 3 Year
NV-QUAD-WKSE-R-4Y=	Renew NVIDIA Quadro vDWS Subscr 1CCU EDU 4 Year
NV-GRID-VAS-R-1Y=	Renew NVIDIA GRID vApps Subscr 1CCU 1 Year
NV-GRID-VAS-R-3Y=	Renew NVIDIA GRID vApps Subscr 1CCU 3 Year
NV-GRID-VAS-R-4Y=	Renew NVIDIA GRID vApps Subscr 1CCU 4 Year
NV-GRID-VAS-R-5Y=	Renew NVIDIA GRID vApps Subscr 1CCU 5 Year
NV-GRID-PCS-R-1Y=	Renew NVIDIA GRID vPC Subscr 1CCU 1 Year
NV-GRID-PCS-R-3Y=	Renew NVIDIA GRID vPC Subscr 1CCU 3 Year
NV-GRID-PCS-R-4Y=	Renew NVIDIA GRID vPC Subscr 1CCU 4 Year
NV-GRID-PCS-R-5Y=	Renew NVIDIA GRID vPC Subscr 1CCU 5 Year
NV-QUAD-WKP-R-1Y=	Renew NVIDIA Quadro vDWS SUMS 1CCU 1 Year
NV-QUAD-WKP-R-3Y=	Renew NVIDIA Quadro vDWS SUMS 1CCU 3 Year
NV-QUAD-WKP-R-5Y=	Renew NVIDIA Quadro vDWS SUMS 1CCU 5 Year

Table 42 Spare Parts (continued)

Product ID (PID)	PID Description
NV-QUAD-WKPE-R-1Y=	Renew NVIDIA Quadro vDWS SUMS 1CCU EDU 1 Year
NV-QUAD-WKPE-R-3Y=	Renew NVIDIA Quadro vDWS SUMS 1CCU EDU 3 Year
NV-QUAD-WKPE-R-5Y=	Renew NVIDIA Quadro vDWS SUMS 1CCU EDU 5 Year
NV-GRID-VAP-R-1Y=	Renew NVIDIA GRID vApps SUMS 1CCU 1 Year
NV-GRID-VAP-R-3Y=	Renew NVIDIA GRID vApps SUMS 1CCU 3 Year
NV-GRID-VAP-R-5Y=	Renew NVIDIA GRID vApps SUMS 1CCU 5 Year
NV-GRID-PCP-R-1Y=	Renew NVIDIA GRID vPC SUMS 1CCU 1 Year
NV-GRID-PCP-R-3Y=	Renew NVIDIA GRID vPC SUMS 1CCU 3 Year
NV-GRID-PCP-R-5Y=	Renew NVIDIA GRID vPC SUMS 1CCU 5 Year
NV-GRD-VA2WKP-5S=	Upgrade NVIDIA VDI APPs to Quadro vDWS 1CCU; 5Yr SUMS Req'd
NV-GRD-VA2PCP-5S=	Upgrade NVIDIA VDI APPs to vPC 1CCU; 5Yr SUMS Req'd
NV-GRD-VA2WKPE-5S=	Upgrade NVIDIA VDI to Quadro vDWS 1CCU; 5Yr SUMS Req'd
NV-GRD-PC2WKP-5S=	Upgrade NVIDIA vPC to Quadro vDWS 1CCU; 5Yr SUMS Req'd
NV-GRD-PC2WKPE-5S=	Upgrade NVIDIA vPC to Quadro vDWS 1CCU; 5Yr SUMS Req'd
Power Supply	
PSU (Input High Line 210VAC)	
HX-PSU1-1050W=	1050W AC PSU Platinum (Not EU/UK Lot 9 Compliant)
HX-PSUV2-1050DC=	1050W -48V DC Power Supply for Rack Server
HX-PSU1-1600W=	1600W AC PSU Platinum (Not EU/UK Lot 9 Compliant)
HX-PSU1-2300W=	2300W AC Power Supply for Rack Servers Titanium
PSU (Input Low Line 110VAC)	
HX-PSU1-1050W=	1050W AC PSU Platinum (Not EU/UK Lot 9 Compliant)
HX-PSUV2-1050DC=	1050W -48V DC Power Supply for Rack Server
HX-PSU1-2300W=	2300W AC Power Supply for Rack Servers Titanium
HX-PSU1-1050ELV	1050W AC PSU Enhanced Low Line (Not EU/UK Lot 9 Compliant)
Power Cables	
CAB-48DC-40A-8AWG=	C-Series -48VDC PSU Power Cord, 3.5M, 3 Wire, 8AWG, 40A
CAB-N5K6A-NA=	Power Cord, 200/240V 6A, North America
CAB-AC-L620-C13=	AC Power Cord, NEMA L6-20 - C13, 2M/6.5ft

Table 42 Spare Parts (continued)

Product ID (PID)	PID Description
CAB-C13-CBN=	CABASY,WIRE,JUMPER CORD, 27" L, C13/C14, 10A/250V
CAB-C13-C14-2M=	CABASY,WIRE,JUMPER CORD, PWR, 2 Meter, C13/C14,10A/250V
CAB-C13-C14-AC=	CORD,PWR,JMP,IEC60320/C14,IEC6 0320/C13, 3.0M
CAB-250V-10A-AR=	Power Cord, 250V, 10A, Argentina
CAB-9K10A-AU=	Power Cord, 250VAC 10A 3112 Plug, Australia
CAB-250V-10A-CN=	AC Power Cord - 250V, 10A - PRC
CAB-9K10A-EU=	Power Cord, 250VAC 10A CEE 7/7 Plug, EU
CAB-250V-10A-ID=	Power Cord, SFS, 250V, 10A, India
CAB-250V-10A-IS=	Power Cord, SFS, 250V, 10A, Israel
CAB-9K10A-IT=	Power Cord, 250VAC 10A CEI 23-16/VII Plug, Italy
CAB-9K10A-SW=	Power Cord, 250VAC 10A MP232 Plug, Switzerland
CAB-9K10A-UK=	Power Cord, 250VAC 10A BS1363 Plug (13 A fuse), UK
CAB-9K12A-NA=	Power Cord, 125VAC 13A NEMA 5-15 Plug, North America
CAB-250V-10A-BR=	Power Cord - 250V, 10A - Brazil
CAB-C13-C14-2M-JP=	Power Cord C13-C14, 2M/6.5ft Japan PSE mark
CAB-9K10A-KOR=	Power Cord, 125VAC 13A KSC8305 Plug, Korea
CAB-ACTW=	AC Power Cord (Taiwan), C13, EL 302, 2.3M
CAB-JPN-3PIN=	Japan, 90-125VAC 12A NEMA 5-15 Plug, 2.4m
Rail Kit	
HX-RAIL-M6=	Ball Bearing Rail Kit for C220 & C240 M6 rack servers
CMA	
HX-CMA-240M6=	Reversible CMA for C240 M6 ball bearing rail kit
Security	
HX-TPM-002C=	TPM 2.0, TCG, FIPS140-2, CC EAL4+ Certified, for M6 servers
HX-INT-SW02=	C220 and C240 M6 Chassis Intrusion Switch
Bezel	
HXAF240C-BZL-M5SN	HXAF240C M5 All NVMe Security Bezel
HXAF240C-BZL-M5SX	HXAF240C M5 Security Bezel
HX240C-BZL-M5S	HX240C M5 Security Bezel

Notes:

1. This part is included with the purchase of option or spare CPU or CPU processor kits.
2. Order an extender board and two matching M.2 SATA SSDs along with a boot-optimized RAID controller (see [STEP 7 SELECT DRIVES](#)). See [Figure 16 on page 83](#) for the location of the extender board connector on the motherboard. The motherboard extender board connector accepts the extender board and the extender board accepts the boot-optimized RAID controller.

UPGRADING or REPLACING CPUs



NOTE: Before servicing any CPU, do the following:

- Decommission and power off the server.
- Slide the HX240C M6 All NVMe/All Flash/Hybrid Server Nodes out from the rack.
- Remove the top cover.

To replace an existing CPU, follow these steps:

(1) Have the following tools and materials available for the procedure:

- T-30 Torx driver—Supplied with replacement CPU.
- #1 flat-head screwdriver—Supplied with replacement CPU.
- CPU assembly tool—Supplied with replacement CPU. Can be ordered separately as Cisco PID UCS-CPUAT=.
- Heatsink cleaning kit—Supplied with replacement CPU. Can be ordered separately as Cisco PID UCSX-HSCK=.
- Thermal interface material (TIM)—Syringe supplied with replacement CPU. Can be ordered separately as Cisco PID UCS-CPU-TIM=.

(2) Order the appropriate replacement CPU from [Table 6 on page 27](#):

Carefully remove and replace the CPU and heatsink in accordance with the instructions found in “M5 server Installation and Service Guide” found at:

https://www.cisco.com/c/en/us/td/docs/unified_computing/ucs/c/hw/C240M5/install/C240M5/C240M5_chapter_010.html?bookSearch=true#concept_bfk_kwp_hz

To add a new CPU, follow these steps:

(1) Have the following tools and materials available for the procedure:

- T-30 Torx driver—Supplied with new CPU.
- #1 flat-head screwdriver—Supplied with new CPU
- CPU assembly tool—Supplied with new CPU. Can be ordered separately as Cisco PID UCS-CPUAT=
- Thermal interface material (TIM)—Syringe supplied with replacement CPU. Can be ordered separately as Cisco PID UCS-CPU-TIM=

(2) Order the appropriate new CPU from [Table 6 on page 27](#)

(3) Order one heat sink for each new CPU. Order PID UCSC-HSHP-240M6= for servers with no GPU. Order PID UCSC-HSLP-M6= for servers with GPUs.

Carefully install the CPU and heatsink in accordance with the instructions found in “M5 server Installation and Service Guide,” found at:

https://www.cisco.com/c/en/us/td/docs/unified_computing/ucs/c/hw/C240M5/install/C240M5/C240M5_chapter_010.html?bookSearch=true#concept_bfk_kwp_hz

UPGRADING or REPLACING MEMORY



NOTE: Before servicing any DIMM or PMem, do the following:

- Decommission and power off the server.
- Remove the top cover from the server
- Slide the server out the front of the chassis.

To add or replace DIMMs or PMem, follow these steps:

Step 1 Open both DIMM connector latches.

Step 2 Press evenly on both ends of the DIMM until it clicks into place in its slot

Note: Ensure that the notch in the DIMM aligns with the slot. If the notch is misaligned, it is possible to damage the DIMM, the slot, or both.

Step 3 Press the DIMM connector latches inward slightly to seat them fully.

Step 4 Populate all slots with a DIMM or DIMM blank. A slot cannot be empty.

Figure 26 Replacing Memory

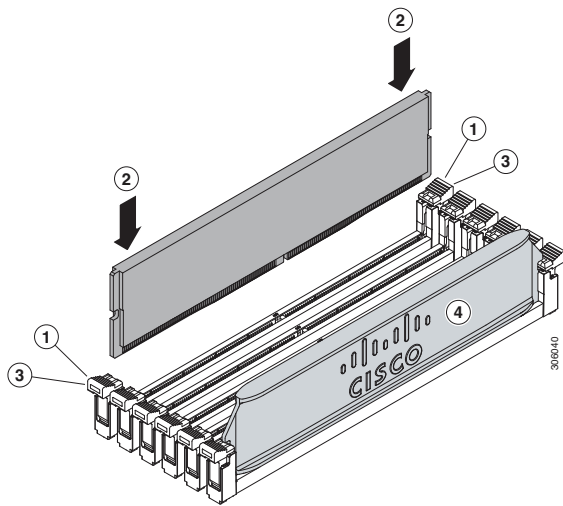

For additional details on replacing or upgrading DIMMs and PMem, see “Cisco M5 Server Installation and Service Guide” found at this link:

https://www.cisco.com/c/en/us/td/docs/unified_computing/ucs/c/hw/C240M5/install/C240M5/C240M5_chapter_010.html?bookSearch=true#concept_c53_tbp_hz

TECHNICAL SPECIFICATIONS

Dimensions and Weight

Table 43 HX240C M6 All NVMe/All Flash/Hybrid Server Nodes Dimensions and Weight

Parameter	Value
Height	3.42 in. (8.7 cm)
Width (Not including slam latches)	16.9 in. (42.9 cm)
Width (including slam latches)	18.9 in. (48.0 cm)
Depth	30 in. (76.2 cm)
Front Clearance	3 in. (76 mm)
Side Clearance	1 in. (25 mm)
Rear Clearance	6 in. (152 mm)
Weight	
Weight with following options and no rail kit: 0 HDD, 0 CPU, 0 DIMM, and 1 2300 W power supply	35.7 lbs (16.2 kg)
Weight with following options and including rail kit: 0 HDD, 0 CPU, 0 DIMM, and 1 2300 W power supply	44 lbs (20 kg)
Weight with following options and no rail kit: 1 HDD, 1 CPU, 1 DIMM, and 1 2300 W power supply	37.6 lbs (17 kg)
Weight with following options and including rail kit: 1 HDD, 1 CPU, 1 DIMM, and 1 2300 W power supply	45.9 lbs (20.8 kg)
Weight with following options and no rail kit: 8 HDDs, 2 CPUs, 32 DIMMs, and 2 2300 W power supplies	44.71 lbs (20.28 kg)
Weight with following options and including rail kit: 8 HDDs, 2 CPUs, 32 DIMMs, and 2 2300 W power supplies	49.2 lbs (22.32 kg)
Weight with following options and no rail kit: 0 HDD, 0 CPU, 0 DIMM, and 1 2300 W power supply	33.14 lbs (15 kg)
Weight with following options and including rail kit: 0 HDD, 0 CPU, 0 DIMM, and 1 2300 W power supply	41.45 lbs (18.8 kg)
Weight with following options and no rail kit: 1 HDD, 1 CPU, 1 DIMM, and 1 2300 W power supply	40.55 lbs (18.4kg)
Weight with following options and including rail kit: 1 HDD, 1 CPU, 1 DIMM, and 1 2300 W power supply	48.86 lbs (22.2 kg)
Weight with following options and no rail kit: 24 HDDs, 2 CPUs, 32 DIMMs, and 2 2300 W power supplies	58.8 lbs (26.7 kg)

Table 43 HX240C M6 All NVMe/All Flash/Hybrid Server Nodes Dimensions and Weight

Parameter	Value
Weight with following options and including rail kit: 24 HDDs, 2 CPUs, 32 DIMMs, and 2 2300 W power supplies	61.7 lbs (28 kg)

Power Specifications

The server is available with the following types of power supplies:

- 1050 W (AC) power supply (see [Table 44](#)).
- 1050 W V2 (DC) power supply (see [Table 45](#))
- 1600 W (AC) power supply (see [Table 46](#))
- 2300 W (AC) power supply (see [Table 47](#))

Table 44 HX240C M6 All NVMe/All Flash/Hybrid Server Nodes Power Specifications (1050 W AC power supply)

Parameter	Specification			
Input Connector	IEC320 C14			
Input Voltage Range (V rms)	100 to 240			
Maximum Allowable Input Voltage Range (V rms)	90 to 264			
Frequency Range (Hz)	50 to 60			
Maximum Allowable Frequency Range (Hz)	47 to 63			
Maximum Rated Output (W) ¹	800		1050	
Maximum Rated Standby Output (W)	36			
Nominal Input Voltage (V rms)	100	120	208	230
Nominal Input Current (A rms)	9.2	7.6	5.8	5.2
Maximum Input at Nominal Input Voltage (W)	889	889	1167	1154
Maximum Input at Nominal Input Voltage (VA)	916	916	1203	1190
Minimum Rated Efficiency (%) ²	90	90	90	91
Minimum Rated Power Factor ²	0.97	0.97	0.97	0.97
Maximum Inrush Current (A peak)	15			
Maximum Inrush Current (ms)	0.2			
Minimum Ride-Through Time (ms) ³	12			

Notes:

1. Maximum rated output is limited to 800W when operating at low-line input voltage (100-127V)
2. This is the minimum rating required to achieve 80 PLUS Platinum certification, see test reports published at <http://www.80plus.org/> for certified values
3. Time output voltage remains within regulation limits at 100% load, during input voltage dropout

Table 45 HX240C M6 All NVMe/All Flash/Hybrid Server Nodes Power Specifications (1050 W V2 DC power supply)

Parameter	Specification
Input Connector	Molex 42820
Input Voltage Range (V rms)	-48
Maximum Allowable Input Voltage Range (V rms)	-40 to -72
Frequency Range (Hz)	NA
Maximum Allowable Frequency Range (Hz)	NA
Maximum Rated Output (W)	1050
Maximum Rated Standby Output (W)	36
Nominal Input Voltage (V rms)	-48
Nominal Input Current (A rms)	24
Maximum Input at Nominal Input Voltage (W)	1154
Maximum Input at Nominal Input Voltage (VA)	1154
Minimum Rated Efficiency (%) ¹	91
Minimum Rated Power Factor ¹	NA
Maximum Inrush Current (A peak)	15
Maximum Inrush Current (ms)	0.2
Minimum Ride-Through Time (ms) ²	5

Notes:

1. This is the minimum rating required to achieve 80 PLUS Platinum certification, see test reports published at <http://www.80plus.org/> for certified values
2. Time output voltage remains within regulation limits at 100% load, during input voltage dropout

Table 46 HX240C M6 All NVMe/All Flash/Hybrid Server Nodes 1600 W (AC) Power Supply Specifications

Parameter	Specification			
Input Connector	IEC320 C14			
Input Voltage Range (V rms)	200 to 240			
Maximum Allowable Input Voltage Range (V rms)	180 to 264			
Frequency Range (Hz)	50 to 60			
Maximum Allowable Frequency Range (Hz)	47 to 63			
Maximum Rated Output (W)	1600			
Maximum Rated Standby Output (W)	36			
Nominal Input Voltage (V rms)	100	120	208	230
Nominal Input Current (A rms)	NA	NA	8.8	7.9
Maximum Input at Nominal Input Voltage (W)	NA	NA	1778	1758
Maximum Input at Nominal Input Voltage (VA)	NA	NA	1833	1813
Minimum Rated Efficiency (%) ¹	NA	NA	90	91
Minimum Rated Power Factor ²	NA	NA	0.97	0.97
Maximum Inrush Current (A peak)	30			
Maximum Inrush Current (ms)	0.2			
Minimum Ride-Through Time (ms) ²	12			

Notes:

1. This is the minimum rating required to achieve 80 PLUS Platinum certification, see test reports published at <http://www.80plus.org/> for certified values
2. Time output voltage remains within regulation limits at 100% load, during input voltage dropout

Table 47 HX240C M6 All NVMe/All Flash/Hybrid Server Nodes 2300 W (AC) Power Supply Specifications

Parameter	Specification			
Input Connector	IEC320 C20			
Input Voltage Range (Vrms)	100 to 240			
Maximum Allowable Input Voltage Range (Vrms)	90 to 264			
Frequency Range (Hz)	50 to 60			
Maximum Allowable Frequency Range (Hz)	47 to 63			
Maximum Rated Output (W) ¹	2300			
Maximum Rated Standby Output (W)	36			
Nominal Input Voltage (Vrms)	100	120	208	230
Nominal Input Current (Arms)	13	11	12	10.8
Maximum Input at Nominal Input Voltage (W)	1338	1330	2490	2480
Maximum Input at Nominal Input Voltage (VA)	1351	1343	2515	2505
Minimum Rated Efficiency (%) ²	92	92	93	93
Minimum Rated Power Factor ²	0.99	0.99	0.97	0.97
Maximum Inrush Current (A peak)	30			
Maximum Inrush Current (ms)	0.2			
Minimum Ride-Through Time (ms) ³	12			

Notes:

1. Maximum rated output is limited to 1200W when operating at low-line input voltage (100-127V)
2. This is the minimum rating required to achieve 80 PLUS Titanium certification, see test reports published at <http://www.80plus.org/> for certified values
3. Time output voltage remains within regulation limits at 100% load, during input voltage dropout

For configuration-specific power specifications, use the Cisco UCS Power Calculator at this URL:

<http://ucspowercalc.cisco.com>

Environmental Specifications

The environmental specifications for the HX240C M6 All NVMe/All Flash/Hybrid Server Nodes are listed in [Table 48](#).

Table 48 Environmental Specifications

Parameter	Minimum
Operating Temperature	<p>Dry bulb temperature of 10°C to 35°C (50°F to 95°F)</p> <p>Maximum temperature change of 20°C (36°F) per hour (a temperature change within a specified period of time and not a rate of change)</p> <p>Humidity condition: Uncontrolled, not to exceed 50% RH starting condition</p> <p>Derate the maximum temperature by 1°C (33.8°F) per every 305 meters of altitude above 900m</p>
Extended Operating Temperature	<p>5°C to 40°C (41°F to 104°F) with no direct sunlight</p> <p>Humidity condition: Uncontrolled, not to exceed 50% RH starting condition</p> <p>Derate the maximum temperature by 1°C (33.8°F) per every 305 meters of altitude above 900m</p>
Non-Operating Temperature	Dry bulb temperature of -40°C to 65°C (-40°F to 149°F)
Operating Relative Humidity	<p>10% to 90% and 28°C (82.4°F) maximum dew-point temperature, non-condensing environment</p> <p>Minimum to be higher (more moisture) of -12°C (10.4°F) dew point or 8% relative humidity</p> <p>Maximum to be 24°C (75.2°F) dew point or 90% relative humidity</p>
Non-Operating Relative Humidity	5% to 93% relative humidity, non-condensing, with a maximum wet bulb temperature of 28°C across the 20°C to 40°C dry bulb range.
Maximum Operating Duration	Unlimited
Operating Altitude	A maximum elevation of 3050 meters (10,006 ft)
Non-Operating Altitude	An elevation of 0 to 12,000 meters (39,370 ft)
Sound Power level, Measure A-weighted per ISO7779 LWAd (Bels) Operation at 23°C (73°F)	5.5
Sound Pressure level, Measure A-weighted per ISO7779 LpAm (dBA) Operation at 23°C (73°F)	40

Extended Operating Temperature Hardware Configuration Limits

Table 49 HX240C M6 All NVMe/All Flash/Hybrid Server Nodes Extended Operating Temperature Hardware Configuration Limits

Platform ¹	ASHRAE A3 (5°C to 40°C) ²	ASHRAE A4 (5°C to 45°C) ³
Processors:	155W+	155W+ and 105W+ (4 or 6 Cores)
Memory:	LRDIMMs	LRDIMMs
Storage:	M.2 SATA SSDs NVMe SSDs	M.2 SATA SSDs NVMe SSDs HDDs or SSDs (Rear Bays)
Peripherals:	PCIe NVMe SSDs GPUs	PCIe NVMe SSDs GPUs VICs (Slots 1 and 4) NICs (Slots 1 and 4) HBAs (Slots 1 and 4)

Notes:

1. Two PSUs are required and PSU failure is not supported
2. Non-Cisco UCS qualified peripherals and/or peripherals that consume more than 25W are not supported
3. High power or maximum power fan control policy must be applied

Compliance Requirements

The regulatory compliance requirements for HX-Series servers are listed in [Table 50](#)

Table 50 HX-Series Regulatory Compliance Requirements

Parameter	Description
Regulatory Compliance	Products should comply with CE Markings per directives 2014/30/EU and 2014/35/EU
Safety	UL 60950-1 Second Edition CAN/CSA-C22.2 No. 60950-1 Second Edition EN 60950-1 Second Edition IEC 60950-1 Second Edition AS/NZS 60950-1 GB4943 2001
EMC - Emissions	47CFR Part 15 (CFR 47) Class A AS/NZS CISPR32 Class A CISPR32 Class A EN55032 Class A ICES003 Class A VCCI Class A EN61000-3-2 EN61000-3-3 KN32 Class A CNS13438 Class A
EMC - Immunity	EN55024 CISPR24 EN300386 KN35



Americas Headquarters
Cisco Systems, Inc.
San Jose, CA

Asia Pacific Headquarters
Cisco Systems (USA) Pte. Ltd.
Singapore

Europe Headquarters
Cisco Systems International BV Amsterdam,
The Netherlands

Cisco has more than 200 offices worldwide. Addresses, phone numbers, and fax numbers are listed on the Cisco Website at www.cisco.com/go/offices.

Cisco and the Cisco Logo are trademarks of Cisco Systems, Inc. and/or its affiliates in the U.S. and other countries. A listing of Cisco's trademarks can be found at www.cisco.com/go/trademarks. Third party trademarks mentioned are the property of their respective owners. The use of the word partner does not imply a partnership relationship between Cisco and any other company. (1005R)

